

BenQ

BenQ M300

Mobile Phone User's Manual

Copyright

© 2004. BENQ Corporation. All rights reserved. No part of this publication may be reproduced, transmitted, transcribed, stored in a retrieval system or translated into any language or computer language, in any form or by any means, electronic, mechanical, magnetic, optical, chemical, manual or otherwise, without the prior written permission of BENQ Corporation.

* This publication includes images from CorelDRAW® 9 which are protected by the copyright laws of the U.S., Canada and elsewhere. Used under license.

Disclaimer

BENQ Corporation makes no representations or warranties, either expressed or implied, with respect to the contents hereof and specifically disclaims any warranties, merchantability or fitness for any particular purpose. Further, BENQ Corporation reserves the right to revise this publication and to make changes from time to time in the contents hereof without obligation of BENQ Corporation to notify any person of such revision or changes.

Safety Information

For your safety, please read the guidelines below carefully before you use your phone:

Exposure to Radio Frequency Signals

Max. SAR measurement

EU: GSM900: 0.621 mW/g; DCS1800: 0.259 mW/g.

USA: PCS1900: 0.641 mW/g.



To avoid exceeding the FCC RF exposure limits, please do not wear the phone in front of your chest.

SAR compliance for body-worn operations is restricted to belt-clips, holsters or similar accessories that have no metallic component in the assembly and must provide at least 1.5 cm separation between the device, including its antenna, and the user's body.

Your wireless handheld portable telephone is a low power transmitter and receiver. When it is ON, it receives and also sends out radio frequency (RF) signals.

European and international agencies have set standards and recommendations for the protection of public exposure to RF electromagnetic energy.

- International Commission on Non-Ionizing Radiation Protection (ICNIRP) 1996
- Verband Deutscher Elektrikingenieur (VDE) DIN- 0848
- Directives of the European Community, Directorate General V in Matters of Radio Frequency Electromagnetic Energy
- National Radiological Protection Board of the United Kingdom, GS 11, 1988
- American National Standards Institute (ANSI) IEEE. C95.1- 1992
- National Council on Radiation Protection and Measurements (NCRP). Report 86

- Department of Health and Welfare Canada. Safety Code 6

These standards are based on extensive scientific review. For example, over 120 scientists, engineers and physicians from universities, government health agencies and industry reviewed the available body of research to develop the updated ANSI Standard.

The design of your phone complies with these standards when used normally.

Specific Operating Restrictions

No metallic component allowed in body-worn accessories.

Antenna Care

Use only the supplied or approved replacement antenna. Unauthorized antennas, modifications or attachments may damage the phone and violate FCC regulations.

Phone Operation

Normal Position: Hold the phone as you would any other telephone with the antenna pointed up and over your shoulder.

For your phone to operate most efficiently, do not touch the antenna unnecessarily when the phone is in use. Contact with the antenna affects call quality and may cause the phone to operate at higher power level than otherwise needed.

Batteries

All batteries can cause property damage, injury or burns if a conductive material such as jewelry, keys or beaded chains touches exposed terminals. The material may complete electrical circuit and become quite hot. To protect against such unwanted current drain, exercise care in handling any charged battery, particularly when placing it inside your pocket, purse or other container with metal objects. When battery is detached from the phone, your batteries are packed with a protective battery cover; please use this cover for storing your batteries when not in use.

Driving

Check the laws and regulations on the use of wireless telephones in the areas where you drive. Always obey them. Also, if using your phone while driving, please:

- Give full attention to driving--driving safety is your first responsibility.
- Use hands-free operation, if available.
- Pull off the road and park before making or answering a call if driving conditions so require.

Electronic Devices

Most modern electronic equipment is shielded from RF signals. However, certain electronic equipment may not be shielded against the RF signals from your wireless phone.

Pacemakers

The Health Industry Manufacturers Association recommends that a minimum separation of six (6") inches be maintained between a handheld wireless phone and a pacemaker to avoid potential interference with the pacemaker. These recommendations are consistent with the independent research by and recommendations of Wireless Technology Research.

Persons with pacemakers:

- Should **ALWAYS** keep the phone more than six inches from their pacemaker when the phone is turned **ON**.
- Should not carry the phone in a breast pocket.
- Should use the ear opposite the pacemaker to minimize the potential for interference.

If you have any reason to suspect that the interference is taking place, turn your phone **OFF** immediately.

Hearing Aids

Some digital wireless phones may interfere with some hearing aids. In the event of such interference you may want to consult your hearing aid manufacturer to discuss alternatives.

Other Medical Devices

If you use any other personal medical device, consult the manufacturer of your device to determine if they are adequately shielded from external RF energy. Your physician may be able to assist you in obtaining this information.

Turn your phone **OFF** in health care facilities when any regulations posted in these areas instruct you to do so. Hospitals or health care facilities may be using equipment that could be sensitive to external RF energy.

Vehicles

RF signals may affect improperly installed or inadequately shielded electronic systems in motor vehicles. Check with the manufacturer or its representative regarding your vehicle. You should also consult the manufacturer of any equipment that has been added to your vehicle.

Posted Facilities

Turn your phone **OFF** in any facility where posted notice so requires.

Aircraft

FCC regulations prohibit using your phone while in the air. Switch **OFF** your phone before boarding an aircraft.

Blasting Areas

To avoid interfering with blasting operations, turn your phone **OFF** when in a “blasting area” or in area posted “TURN OFF TWO-WAY RADIO.” Obey all signs and instructions.

Potentially Explosive Atmospheres

Turn your phone **OFF** and do not remove the battery when in any area with a potentially explosive atmosphere and obey all signs and instructions. Sparks, from your battery, in such areas could cause an explosion or fire resulting in bodily injury or even death.

Areas with a potentially explosive atmosphere are often, but not always clearly marked. They include fueling areas such as gasoline stations; below deck on boats; fuel or chemical transfer or storage facilities; vehicles using liquefied petroleum gas (such as propane or butane); areas where the air contains chemicals or particles, such as grain, dust, or metal powders; and any other area where you would normally be advised to turn off your vehicle engine.

For Vehicles Equipped with an Air Bag

An air bag inflates with great force. **DO NOT** place objects, including both installed or portable wireless equipment, in the area over the air bag or in the air bag deployment area. If in-vehicle wireless equipment is improperly installed and the air bag inflates, serious injury could result.

Federal Communications Commission

This device complies with Part 15 of the FCC Rules. Operation is subject to the following two conditions:

1. this device may not cause harmful interference, and
2. this device must accept any interference received, including interference that may cause undesired operation.

This equipment has been tested and found to comply with the limits for a Class B digital device, pursuant to Part 15 of the FCC Rules. These limits are designed to provide reasonable protection against harmful interference in a residential installation. This equipment generates, uses and can radiate radio frequency energy and, if not installed and used in accordance with the instructions, may cause harmful interference to radio communications. However, there is no guarantee that interference will not occur in a particular installation. If this equipment does cause harmful interference to radio or television reception, which can be determined by turning the equipment off and on, the user is encouraged to try to correct the interference by one or more of the following measures:

- Reorient or relocate the receiving antenna.
- Increase the separation between the equipment and receiver.
- Connect the equipment into an outlet on a circuit different from that to which the receiver is connected.
- Consult the dealer or an experienced radio/TV technician for help.

Changes or modifications not expressly approved by the party responsible for compliance could void the user's authority to operate the equipment.

European Union Directives Conformance Statement

This device complies with the OJ-Directive as below:

Electromagnetic Compatibility Directive (89/336/EEC), Low Voltage Directive (73/23/EEC)

And R&TTE Directive (99/05/EEC).



And also complies with the standard:

3GPP TS 51.010-1

EN 301 511

EN 30360/ EN30361

ETSI EN 301 489-1/-7

EN 60950

Table of Contents

1. Safety Information	i
2. Preparing Your Phone For Use	1
Inserting Your SIM Card	1
Installing the Battery	2
Installing the Back Cover	2
Charging the Phone.....	3
Turning the Phone On	4
3. Getting to Know Your Phone	6
Your Phone at a Glance.....	6
Standby Screen.....	8
Main Screen.....	8
Icons in the LCD display's Status Bar.....	9
Using the Keys in the Standby Mode	12
Menu Navigation.....	15
Main menu map	21
4. Using Your Phone	22
Making a Phone Call	22
Ending a Phone Call.....	22
Answering a Phone Call	23
Rejecting an Incoming Call.....	23
Making an International Call.....	23
Making an Emergency Call	24
Dialing an Extension Number	24

Speed Dialing	24
Listening to Voicemails	25
Phone Book.....	26
Adding Contacts to the Phone Book.....	26
SIM Card Phone Book	29
Finding Contacts in the Phone Book	30
Last Missed, Dialed, and Received Calls.....	32
Operations During a Call	34
In-Call Menu	35
Using the Silent Profile.....	38
Camera Function	39
Shortcuts Menu	42
Setting Function Shortcuts	42
Setting Phone Number Shortcuts.....	44
Using Function and Phone Number Shortcuts	45
Messages Menu.....	46
SMS	47
MMS.....	54
SMS Chat	59
Voicemail	61
Cell Broadcast	62
Memory Status	63
Input Modes	64
Changing the Text Input Mode	64
Letter Input Mode (ABC)	65
Numeric Input Mode (123).....	65
Predictive Input Mode (iTap)	65

Symbol Input Mode	67
Direct Connection to URLs	68
5. Menus	70
Phone Book.....	70
Find	70
Add.....	70
Edit	71
Copy	71
Delete	71
Caller Group	71
Business Card	72
My Number	73
Memory Status	73
Call Records	74
Missed Calls	74
Received Calls	74
Dialed Calls.....	74
Cleanup All	74
Call Duration.....	74
Call Cost.....	75
Messages.....	76
Games.....	77
Games.....	77
Camera	80
Media Center	80
Album	80
Image.....	81

Melody	82
Cleanup All	83
Memory Status	83
Tools.....	84
Alarm	84
World Clock	85
Calendar.....	86
Shortcuts.....	87
Calculator.....	88
Currency Converter	88
Stopwatch	89
Oper. Service.....	90
WAP Service	90
Settings	104
Date & Time	104
Auto Power On/Off.....	104
Profiles	105
Display	108
Audio.....	110
Call Settings	110
Network	114
Security	116
Power Saving Mode.....	118
Language	118
Input.....	119
Restore	119
6. Care and Maintenance	120

7. Troubleshooting.....	121
--------------------------------	------------

1 Preparing Your Phone For Use

Inserting Your SIM Card

Slide the entire SIM card into the slot in the direction of arrow shown on the compartment, with the metal contacts of the SIM card facing down and the cut corner at the top left.

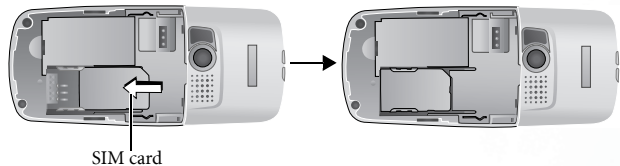

A SIM card can be easily damaged if its metal contacts become scratched. Therefore, take special care when holding or inserting it.



If you wish to remove the SIM card, you must first press down the stay, then push the SIM card out of the slot.

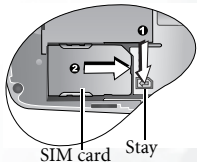

Installing the Battery

1. Place the battery onto the back of the phone, with the battery's contacts facing downwards and the tab on its top edge in alignment with the holes in the battery compartment.
2. Push the battery against the top of the compartment and press it down to click it into the compartment.

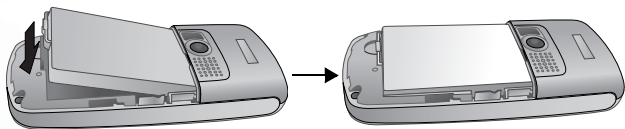

Do not remove the battery when the phone is on. Doing so could cause you to lose personal settings or data stored either on your SIM card or in the phone's memory.

Installing the Back Cover

Place the back cover onto the back of your phone and slide forward until the latch catches the cover.



Charging the Phone

1. Insert the charger connector into the charger socket at the bottom right of your phone. Make sure that the connector is inserted in the right direction (with the arrow sign on the top).

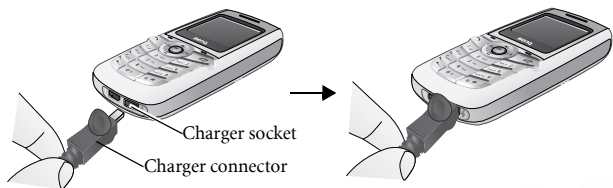

2. Plug the charger into a power outlet.
3. Once the phone is fully charged, remove the charger from both the power outlet and the phone.



- Charging requires approximately 4 hours.

- When charging while the phone is turned off, the LCD display

shows the



animation. If the charging is performed while the

phone is on, the LCD display shows the  icon. The lines showing the battery power level will scroll until the battery is fully charged.

- When the battery is out of power, the phone will play an alert sound to remind you to recharge it and then will automatically turn off.





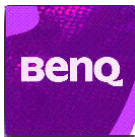

Do not remove the battery while the phone is charging.

Turning the Phone On

1. Long press  to turn the phone on. The phone will display the welcome animation.



- You can select and set a welcome animation, image, or message that will display when you turn on your phone, as well as the music that will be played. Go to the menu: **Settings** → **Display** → **Welcome Message**. For details, please refer to page 108.
- If the welcoming music goes on too long, once the standby screen comes up, you can press  to stop playback.

2. Enter your PIN code. If you enter the PIN code incorrectly, press  (**Clear**) to delete the incorrect numerals. Press and hold  to delete all numerals that have been entered. After completing entry of your PIN code, press  to confirm.



The PIN (Personal Identification Number) is a password provided by a network operator with a SIM card. You need this password in order to use the SIM card.





If you enter the PIN incorrectly 3 times in a row, the SIM card will lock down and no longer be usable. If this happens, you must enter the PUK (Personal Unblocking Key) for that SIM card in order to unlock it. Please contact your network operator to obtain a PUK.



To cancel PIN password authentication, go to the menu **Settings** → **Security** → **PIN Code** → **PIN Code**. Please see page 116.

3. When the PIN code entered has been accepted, the phone will automatically search for the designated network. This search process may take a few seconds.
4. The standby screen will be displayed, as well as network signal strength and the name of the network operator. You can now use the phone.

 If the phone cannot detect the network, the on-screen signal strength meter will show no bars.

 If the phone links to a network that you are not authorized to use, the signal strength meter will show a level of zero. You will only be able to make emergency calls.

2 Getting to Know Your Phone

Your Phone at a Glance

The figure below shows the main parts of your phone:

Front view 1



Bottom and back views

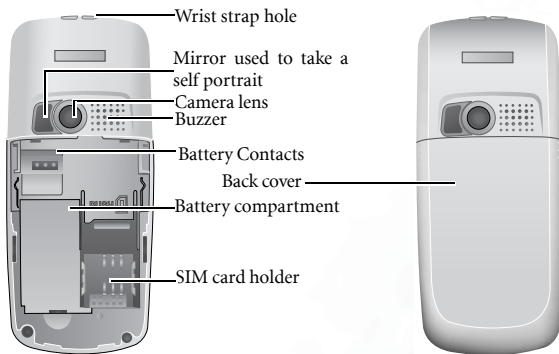
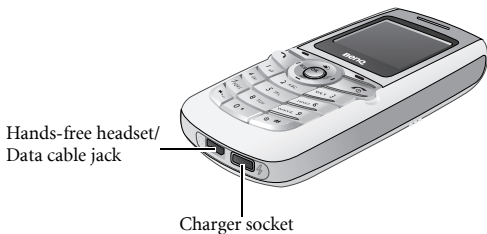

To avoid exceeding the FCC RF exposure limits, please do not wear the phone in front of your chest.

Standby Screen

Main Screen

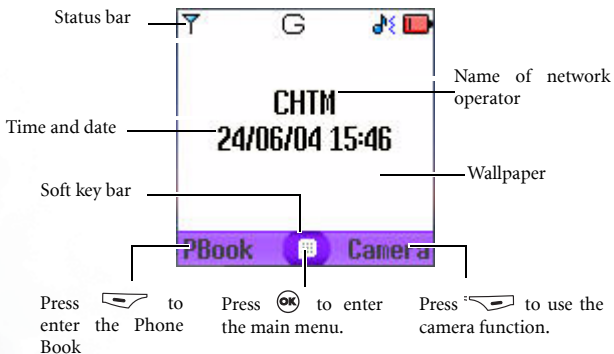

















Icons in the LCD display's Status Bar



- You can set the animation or image you wish to use as wallpaper when the phone is in standby mode by going to the menu **Media Center** → **Album**. Alternatively, you can go to the menu **Settings** → **Display** → **Wallpaper**. See page 80 and page 108.
- To set the current time and date, as well as the format in which they will be shown on standby screen, go to the menu **Settings** → **Date & Time**. See page 104.
- You can go to the menu **Settings** → **Profiles** → **Personal** to change the name of the profile to your own user name. When this profile is activated, your own name will appear in the standby screen on the LCD display. For details, see page 106.
- For enhanced security, you can use the screen lock function. Go to the menu **Settings** → **Security** → **Screen Lock**. If the screen lock is activated, and you have not performed any tasks with the phone for a set time, the phone will automatically bring up the screen lock image. The purpose is to protect any personal data on your phone from being read by other persons. To restore the original display screen, you must enter a password that you provide for this function. For details on settings, see page 118.
- After the standby screen remains idle for 10 seconds, the soft key bar, time and date, as well as all the other words currently displayed will automatically disappear, showing the full-screen wallpaper. You can also press  to display/hide the status bar and words normally shown on the standby screen.

Icon	Function	Description
	Signal strength	Signal strength of the network. The more bars indicated, the stronger the signal.

Icon	Function	Description
	Battery status	Shows the current level of battery power. The more bars indicated, the more power that remains. Four bars: fully charged. No bars: immediate charging needed. When charging the phone, the icon will scroll through the bars until the battery is fully charged.
	GPRS network	GPRS services have been activated on your SIM card.
	Message	Shows that an SMS/MMS message is being received or that there are unread messages. If the icon  appears in red, this indicates that the SIM card's text message memory is full. For information about the message function, see page 46, "Messages Menu".
	WAP message	You've got a WAP message (this icon will only appear when there are no incoming or unread SMS/MMS messages).
	Voicemail	Indicates that you have voicemail messages (this icon will only appear if the function is supported by your network operator).
	Alarm	The alarm is turned on. To set the alarm, go to the menu Tools → Alarm . See page 84.
	Line in use	Shows the number of the line currently in use. To set the line, go to the menu Settings → Call Settings → Active Line . For details, see page 114.
	Vibrate	In the standby screen, press and hold  to activate the silent profile. See page 38, "Using the Silent Profile".

Icon	Function	Description
	Normal	Shows that the Normal profile is in use. To set the operating mode, go to the menu Settings → Profiles . See page 105.
	Meeting	Shows that the Meeting profile is in use.
	Outdoors	Shows that the Outdoors profile is in use.
	Personal	Shows that the Personal profile is in use.
	Handsfree	Shows that the Handsfree profile is in use.
	Divert	Shows that the call divert function is active. To make settings for this function, go to the menu Settings → Call Settings → Call Divert . See page 111.
	Roaming	Roaming has been activated (not your regular network)

Using the Keys in the Standby Mode



 In this user manual, "long-press" means to press and hold down a key for about two seconds before release. "Press" means to press a key and release immediately.









 The chart below is meant only to introduce the commands accessible with keys when the phone is in standby mode. For information on other key commands available in other operating modes, see the pertinent sections in this user manual.



Function keys















- When any key is pressed, the phone will provide aural feedback through keypad tones. To activate or cancel this aural feedback, enter the menu **Settings** → **Profiles**. Scroll to the profile currently in use and press  (**Edit**). Then select **Keypad Tone**. You can also go to **Settings** → **Audio** → **Keypad Tone** to turn the aural feedback on or off. See page 107 and page 110.

Key	Commands and functions
	Power on/off key <ul style="list-style-type: none">• Long-press to turn the phone on or off.• Press this key to reject incoming calls or cancel a call being dialed.
	Send/Answer key <ul style="list-style-type: none">• Press to send or answer a call.• Long-press and your phone will automatically call the last number dialed.• Press to access the list of last missed/dialed/received calls.
	OK key <ul style="list-style-type: none">• Press to open up the main menu and show its first item.

Key	Commands and functions
	<p>Left soft key</p> <ul style="list-style-type: none"> • Press to access the Phone Book (when PBook is shown). • Press to save the phone number keyed in from the standby screen to the Phone Book (when Save is shown).
	<p>Right soft key</p> <ul style="list-style-type: none"> • Press this key to use the camera function (when Camera is shown). • Press this key to delete entered digits one by one; long-press to delete all digits entered (when Clear is shown). • Long-press to turn the silent profile on or off.
	<p>Scroll key</p> <ul style="list-style-type: none"> • Press  to enter the Quick Access menu. For information about the Quick Access menu, see page 42. • Press  to retrieve photos stored in the Album menu. • Press  to enter the Messages menu. For a description of the Messages menu, see page 46. • Press  to select the profile to activate.
	<p>Asterisk key</p> <ul style="list-style-type: none"> • Press this key to enter an asterisk " * ". • To make an international call, long-press this key until the display shows "+", Then enter the recipient's country code, area code and phone number.
	<p>Voicemail key</p> <ul style="list-style-type: none"> • Long-press to dial your voicemail number.

Key	Commands and functions
	<p># key</p> <ul style="list-style-type: none"> • Press to enter "#". • For extensions: After entering a phone number, long-press to enter a "P" and then enter the extension number.
	<p>Alphanumeric keys</p> <ul style="list-style-type: none"> • Press to enter digits in a phone number. • Shortcut key: Long-press a key to immediately access the function, or dial the number, that it represents. See page 42, "Shortcuts Menu".

Alphanumeric keys

Key	Digit	Key	Digit/Symbol/Function
	1		7
	2		8
	3		9
	4		0
	5		* + (long-press)
	6		# P(long-press after entering a phone number)

 Long-pressing an alphanumeric key will access the function it represents, or dial the number that has been assigned to it (shortcut function).

Menu Navigation

When the phone is in standby mode, press **OK** to bring up the main menu and highlight the first item in that menu: **Phone Book**.

 For details on how to use the various functions listed in the menu, see page 70, "Menus".

Main menu

The main menu item to which you have scrolled will be displayed as an animation.

The name of the main menu item you have scrolled to.



Each icon represents a sub-menu.

Indicates that pressing  will return the display to the standby screen.



Sub-menus

The name of the current menu.



The highlighted row is the currently selected item.

Press  to enter the highlighted menu item for editing.

Press  to enter the sub-menu represented by highlighted item or to activate the highlighted function. Press  to scroll up or down to an item.

Press  to return to the previous menu or screen.

Pop-up menus



Press  to enter the highlighted item or activate the function represented by the item.









Press  to scroll up or down to an item.



Press  to close a pop-up menu.

Menu navigation example



The example given below demonstrates how to use menus to change the language setting.

Regular access



<p>1. In the standby mode, press  or to open the main menu.</p>	
<p>2. In the main menu, press  to scroll to the Settings menu icon. Press  to enter this menu.</p>	
<p>3. In the Settings menu, press  to scroll to the Language item, then press  to enter the Language menu.</p>	

4. Press  to scroll to the language you wish to use. Then press  to confirm your selection. If, for example, you wish to set English as the display language, scroll to highlight **English**, and then press . The display will automatically return to the **Settings** menu, displayed in English.





5. Press  (**Back**) repeatedly or press  once to return to the standby screen.



Access through number shortcuts

1. In the standby mode, press  or  to bring up the main menu.





2. The location of items in the main menu corresponds to the position of the  to  keys in the alphanumeric keypad. Thus, pressing  will bring up the **Settings** menu.





3. In the **Settings** menu, the alphanumeric keys  to  represent menu items 1 to 10. Since **Language** is item number 10 in the Settings menu, pressing  will bring up the **Language** sub-menu.



4. Press  to scroll to the language you wish to use. Then press  to confirm your selection. If, for example, you wish to set English as the display language, scroll to highlight **English**, and then press . The display will automatically return to the **Settings** menu, displayed in English.



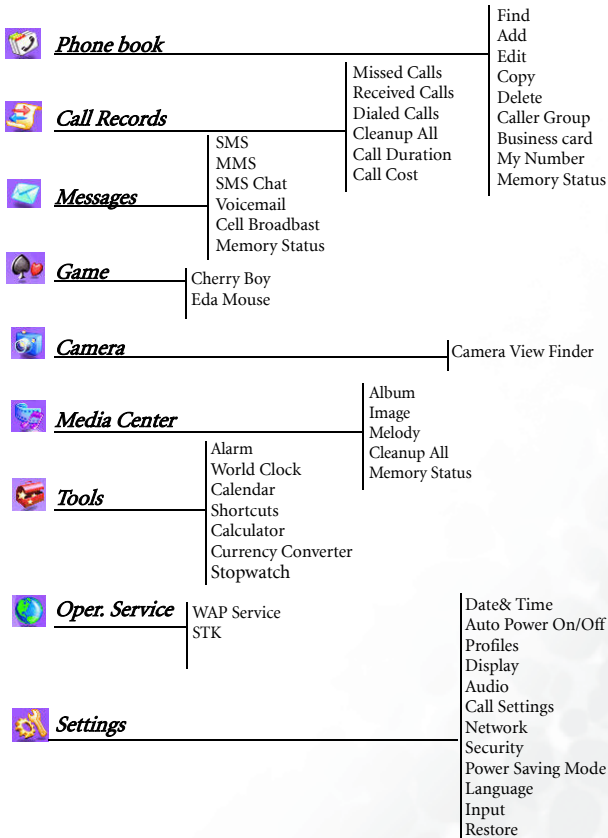

5. Press  (**Back**) repeatedly or press  once to return to the standby screen.

Main menu map





Using Your Phone

Making a Phone Call

To make a phone call, check your phone is powered on showing the idle screen. Enter the desired number using the alphanumeric keys  to . Press  to dial your call.



During a call, you can use the options. See page 35, "In-Call Menu".



To modify a phone number that you have entered, press  (**Clear**) to delete individual digits. Long-press  (**Clear**) or press  to delete all digits entered and return to the standby screen.

Ending a Phone Call

Press  to end a call. The display will show the total call time, and then return to the standby screen.



To cancel a call that is being dialed, press .

 If you also have a call waiting or on hold, after you press , the display will show a menu to allow you to choose the call you wish to end.

Answering a Phone Call

When a call is received, your phone rings or vibrates, with the display showing the caller's number (if supported by your network vendor). If the caller is a contact stored in the Phone Book, the phone will show the name recorded in the Phone Book.



- If the caller is a member of a caller group, the ring tone assigned to this group will sound. The display will show the image ID that is associated with this group as well, to help you identify the caller.
- For information on how to set up caller groups in the Phone Book, see page 26, "Adding Contacts to the Phone Book".





If you wish to change the answering mode so that you can press any key to answer a call, go the menu **Settings** → **Profiles**. After selecting the currently active profile, press  (**Edit**) and go to **Answer Mode** → **Any Key**.

Rejecting an Incoming Call

- Press  to reject the incoming call.



Making an International Call

1. Enter the outgoing international call code, or long-press  until "+" appears on the display.
2. Enter the recipient's country code, area code and phone number. Dial the call by pressing .

Making an Emergency Call



To call emergency services, enter 112 (the international emergency number) and then press  to dial the call. You can make an emergency call even if your phone is locked or cannot access your network, or there is no SIM card inserted, so long as you are within range of a network of the type supported by your phone.

Dialing an Extension Number

After you enter a telephone number, long-press , The phone display will show "P". At this point, you can enter the desired extension number, and then press  to dial it.

Speed Dialing

 You must assign a number key as the shortcut for a particular phone number in order to use speed dialing for that phone number. For information on how to set up a shortcut, see page 42, "Shortcuts Menu".



After you have assigned a number key to serve as the shortcut key for a particular phone number, you can long-press this key when the phone is in the standby mode to dial the corresponding phone number. For example, if you have selected  as the shortcut key for a certain phone number, long-pressing  will dial this number.

Listening to Voicemails

When your voicemail inbox contains new messages, your network vendor will send you a text message to inform you of a new voicemail message (if the network vendor supports it, the voicemail icon  will appear on the LCD display). There are two ways to access and listen to voicemail:

1. When the phone is in standby mode, long press  to directly dial the voicemail phone number and listen to your voicemail messages.
2. Go to the menu **Messages** → **Voicemail** → **Get Voicemail** to dial the voicemail number.



If the voicemail number is not stored on your SIM card or in the phone itself, you will not be able to access your voicemail by long-pressing . Generally speaking, network operators will store the voicemail number on a SIM card before giving it to you. If so, you will be able to dial your voicemail number by long-pressing  when the phone is in standby mode, without needing to manually store this number. If however your network vendor did not store the number on your SIM card, you will need to do this yourself. To save or modify a voicemail phone number, go to the menu **Messages** → **Voicemail** → **Set Number**.

Phone Book

Adding Contacts to the Phone Book

The Phone Book will have different formats and data headings depending on whether you have chosen to use a phone book stored on your SIM card or in your phone's memory. The phone book in your phone's memory can store up to 500 contacts. The capacity of a phone book on your SIM card depends on the particular service provided by your network vendor.

Phone Book in the phone's memory

1. In the standby screen, enter the phone number you wish to store, and then press  (**Save**). The display will show the default data fields for a new contact.





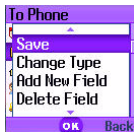

2. In the contact data screen, scroll to the data field that you wish to edit, and then press  (**Options**) to bring up a pop-up menu. You can then use the following options with the contact data:

- **Save:** Save the entries you have entered.
- **Change Type:** Change the category of the phone number (for example, from **Mobile Number** to **Home Number**). This option can only be used in the phone number data field.
- **Add New Field:** Adds other data fields for a contact.
- **Delete Field:** Removes the selected data field.



3. After completing the data for the various fields, you must press  (**Options**) and then select **Save** in order for the contact's data to be stored in the Phone Book.

 If you do not wish to save a modified Phone Book record, press  or  (**Back**) to abort.

 You can also add a new contact by going to the menu **Phone Book** → **Add**.

- The default data fields for a contact are as follows:



The contact's name.





The contact's mobile phone number.



The contact's home phone number.



Used to assign a contact to a caller group. Press  to select a group, and then press .





Used to set a ring tone for the contact. When there is an incoming call from the contact, the phone will play this ring tone.

 A ring tone set in this field will replace the one associated with the contact's caller group, if any.



Used to set the photo that will appear on the phone's display when there is an incoming call from the contact.

 The photo set in this field will replace the image associated with the contact's caller group, if any.

- In addition to the contact data fields described above, you can also add the data fields listed below by pressing  (**Option**) and then selecting **Add New Field**.



The contact's mobile phone number.



The contact's home phone number.



The contact's office phone number.



Other phone number for the contact.



The contact's email address.



The contact's home address.



The contact's office address.



The contact's company name.



The contact's department name.





The contact's job title.



Used for notes about the contact.

SIM Card Phone Book

In the standby mode, press  (**PBook**) and then press  (**Option**), select **Add**. The Add function will prompt you to select from **To SIM** or **To Phone**. Select **To SIM** here to add a contact to your SIM card.



The data fields provided by a SIM card phone book are as follows:



The contact's name.



The contact's mobile phone number.

Used to select a caller group for the contact. Press  to select a group and then press . When there is an incoming call from this contact, the ring tone assigned to this group will sound and the display will show the animation/image associated with the group.



 To set a ring tone and animation/image for each caller group, go to the menu **Phone Book** → **Caller Group**. See page 71.



 You can also go the menu **Phone Book** → **Caller Group** to set a caller group for a contact.

Finding Contacts in the Phone Book

In the standby mode, press  (**PBook**) to display contacts stored in the Phone Book.







There are two ways to locate a specific contact in the Phone Book:



- Press  to scroll through the names (listed in alphabetical order) until the one you want is highlighted.
- Press the alphanumeric key that corresponds to the first letter of the name you wish to locate the appropriate number of times. For instance, if the name starts with "K", you would press  twice for "K". The names starting with "K" will appear, with the first one highlighted. Press  to scroll to the name you want.

 You can also go to the menu **Phone Book** → **Find**, and then enter the full name or the first letter of the name to locate a contact.

When the desired contact's name is highlighted, you can do one of the following:

- Press  to dial the first phone number saved in that contact.
- Press  (**Option**) to bring up a pop-up menu, which contains the following items:
 - **Add:** Add a new contact to the phone book.
 - **Edit:** Edit the Phone Book data for this contact. When you are finished, press . For more information on editing, see page 26.

 If you do not wish to save a modified Phone Book record, press

 (**Back**) or  to abort.

- **Copy to SIM (Phone):** If you are currently using a phone book stored in the phone's memory, you can copy the contact's data to the phone book stored on your SIM card. Conversely, if you are currently using a phone book stored on your SIM card, you can copy the contact's data to the phone book stored in the phone's memory.



The only information that can be copied from a phone book stored in the phone's memory to the one on your SIM card is a contact's name, phone number, and caller group. If a contact has more than one phone number associated with it, when that contact's data is copied from the phone to the SIM card's phone book, each phone number will be stored as separate contact.

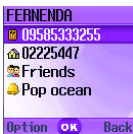

- **Delete:** Erases the contact's data from the Phone Book.
 - **Send vCard:** Attaches the contact's data to a message and send it to others.
- Press **OK** to show the information in all data fields for that contact. You can then perform the following tasks:



- Scroll to the number that you wish to dial, and then press .
- Scroll to the desired data field. If the complete contents cannot be displayed on the screen, or there is no content to display (for example, **Note**), press **OK** to display the complete contents (if the data field is for a voice dialing prompt , you can press **OK** to play the sound of this voice dialing prompt.
- Press **Option** (**Option**) to bring up a pop-up menu that contains the following items:
 - **Add:** Add a new contact to the phone book.

- **Edit:** Used to edit the Phone Book data for this contact. For information on editing, see page 26.











If you do not wish to save a modified Phone Book record, press  or  (**Back**) to abort.

- **Copy to SIM (Phone):** If you are currently using a phone book stored in the phone's memory, you can copy the contact's data to the phone book stored on your SIM card. Conversely, if you are currently using a phone book stored on your SIM card, you can copy the contact's data to the phone book stored in the phone's memory.
- **Delete:** Erases the contact's data from the Phone Book.
- **Call:** Dial the currently highlighted number.
- **Send Msg.:** Send a message (SMS or MMS) to the current highlighted number.
- **Send vCard:** Attaches the contact's data to a message and send to others.

Last Missed, Dialed, and Received Calls

There are two ways you can view the last missed, dialed, and received calls on your phone, as well as information on their date and time:

1. If there have been any missed calls, the display will show a missed call message along with the number of calls that were missed. Press  (**View**), and then press  to scroll to the desired phone number.
2. In the standby mode, press  to view the list of the most recent missed, dialed, and received calls. Press  to scroll to the desired phone number.



 The icon  will appear beside missed calls; the icon  will appear beside dialed calls; the  will appear beside received calls.

 If a phone number has already been stored in the information for a contact in the Phone Book, the display will show the name of this contact.

 If a call for the same number has been missed, dialed, or received two or more times, a note such as "x02" will appear beside the record of the call to show the number of times it was missed, dialed, or received.

 If your network operator is not able to display a certain call's number, the list will not show a number for the call.



When the number for a missed, dialed, or received call is highlighted, you can perform the following tasks:

- Press  to re-dial the number.
- Press  (**Option**) to bring up a pop-up menu:
 - **Save (Edit)**: If the phone number for the call has not been stored in the Phone Book, select the **Save** option to create a contact for this number in the Phone Book. If this phone number is already stored under a contact in the Phone Book, select the **Edit** option to edit this information for this contact. For information about editing Phone Book data, see page 26, "Adding Contacts to the Phone Book".
 - **Delete**: Erases the record of the call from the list.
 - **Call**: Dial the phone number.
 - **Send Msg.:** Send a message to this phone number.
 - **Delete All**: Erase all the call records.
- Press  to display the details on this call such as caller's name and time.







Operations During a Call

 The following options marked with an asterisk (*) are dependent on network support and may require a subscription.

Mute

Press  (**Mute**) to turn off the microphone. The person on the other end of the line will not be able to hear your voice. To restore the microphone's function, press  (**Unmute**).

Putting a Call on Hold*





1. When the only call is active:
 - a. Press  (**Hold**) to hold this call.
 - b. Press  to end this call.
2. When the only call is on hold:
 - a. Press  (**Unhold**) to resume the call.
 - b. Press  to end this call.
3. When there is an active call and a call on hold.
 - a. Press  (**Swap**) to resume the call that is on hold, and put the active call on hold.
 - b. Press  to show on the display a list of calls that you can end.

Making a Second Call*







Enter a phone number, or select one from the phone number or call record, and then press  to dial it. The currently active call will automatically be placed on hold. However, if there is already one active call and another on hold, this action will fail.

Call Waiting*

If there is an incoming call while you are on the phone, a tone will sound through the earpiece and the display will show that a second call is currently waiting. You can handle the waiting call and currently active call in the following ways:

1. Answer the waiting call: Press  the currently active call will automatically be placed on hold. However, if there is already another call on hold, a menu will appear on the display allowing you to select a call to end and then answer the waiting call.
2. Reject the waiting call: Press  or  (**End**). Pressing  (**End**) will immediately reject the waiting call; pressing  will bring up a menu on the display that you can use to select a call to end.

In-Call Menu

If you press  during a call, it will bring up the call menu. Press  to scroll to the desired item (press  to scroll through the menu page by page) and then press  to enter that item; press  (**Back**) to return to the previous menu; press  to return directly to the call menu.

 Items marked with an asterisk (*) depend on network support and may require a subscription.

Phone Book

Accesses data in the Phone Book. For details, see page 26, "Phone Book".

Call Records

Allows you to view information on missed, received, and dialed calls. See page 32, "Last Missed, Dialed, and Received Calls".

Conference*

Conference calls allow you to converse with more than one party at a time. The conference menu contains the following options:

 The maximum number of parties that can be accommodated during a conference call depends on the particular service provided by a network vendor.

Hold/Unhold/Swap*

Toggles the call status.

Join/Private

Adds a party that is on hold to the current conference call, or isolates a single party in a conference call and puts all other parties on hold.

Forward

Allows two parties to connect, while ending one's own call (one of the two parties may be involved in an active call while the other is either on hold or being dialed), so as to allow the two parties to have their own call.

Send DTMF

When the phone is connected with other devices or services, you can send DTMF (Dual Tone Modulation Frequency) strings. DTMF strings are keypad tones that can be sent via the microphone as you dial another number. Your phone will emit the tones in order to communicate with answering machines, pagers, computerized telephone services, and so forth.

Enter the phone number and then press  to send the DTMF string.

End Call

End All

Ends all calls, whether active or on hold.

End Active

Ends only the active call.

End Hold

Ends only a call or calls on hold.

End One

Ends only a single call.

Hold/Unhold/Swap

Toggles the call status.

Mute/Unmute

Activates/cancels the silent mode.

Messages





Enters the SMS (Short Message Service — i.e. text message) menu. For details on the SMS menu, see page 46, "Messages Menu".

Calculator

Allows you to use the calculator. For information about the calculator, see page 88.

Using the Silent Profile

From the standby screen, you can long-press  to activate the Silent profile. Once it is activated, the phone will alert you to an incoming call by vibrating with no ring tone.

- When you long-press  to activate the Silent profile, the phone will vibrate for one second. The icon  will appear in the LCD display's status bar (the external display will show ) to remind you that your phone is currently using the Silent profile.
- To cancel the Silent profile and restore the previously active vibrant and ring tone settings, long-press  .





This feature is very convenient for switching to the Silent profile during, say, a meeting to avoid the disruption caused by a ring tone.





To set and select a profile, please enter the main menu's **Settings** → **Profiles**. See page 105.

Camera Function

You can take photos using your phone's embedded camera, and then set photos as wallpapers for the LCD display's standby screen, or send them to others through MMS.

1. From the standby screen, press  (**Camera**), which will bring up the view finder.
2. Press  (**Option**) to make the following settings for the camera:
 - **Resolution:** Sets the desired resolution for photographing. You have the following resolution values to choose from:

Option	Represented Resolution
High	352 x 288
Medium	176 x 144
Low	80 x 72

- **Scene:** Base on the light conditions of the environment selected, the camera will automatically adjust its color balance in order for you to take best-quality pictures.
 - **Effect:** Enables you to apply a special effect to your image to create an artistic style.
 - **Free Space:** Shows the amount of remaining available memory for storing photos.
3. In the view finder, press  to bring up the resolution and scene status bar. Press  to hide the status bar. The number at the top right corner of the screen indicates the number of photos available to be taken. You will find the following icons on the status bar:



Scene was set to Automatic.



Scene was set to Indoors.



Scene was set to Outdoors.



Scene was set to Night.



One filled star indicates that Low resolution was chosen.

Two filled stars indicate that Medium resolution was chosen.

Three filled stars indicate that High resolution was chosen.





You can also use the camera by going to the menu: **Camera**.

4. After you have completed necessary camera settings, press  to photograph the object when it is in focus. Its photo will then show up on the LCD display.



Please note the following while shooting photos

- The external camera does not have a flash. Please take photos in a well-lit area.
- When taking photos, do not block or touch the camera lens on the back of the phone.
- Always photograph your object with the source of light behind you.
- Do not shake the phone when taking photos.
- Please be sure that the lens is perfectly clean before taking photos. Use a soft cloth to wipe the lens if it is not clean.

5. Press  (**Save**) to save this photo to **Media Center** → **Album**. To take another photo simply press  (**Discard**) to take a new one. After you have saved a photo to the phone, you can manage this photo using the options below:

- **Send Photo:** Sends the picture in a MMS message.

 For information about messaging features, see page 46, "Messages Menu".

- **Set Image ID:** Set the current selected photo as a phone book contact's visual caller ID. When there is an incoming call from that contact, the phone's display will show this photo.

- **New Entry:** Enables you to create a new contact in the Phone Book using the photo as her/his caller ID.

- **Exist Entry:** Associate the current selected photo with a contact in the phone book entries.

 This function is only available for contacts saved in the phone memory's phone book.

- **Set Wallpaper:** Designates this photo as the wallpaper for the LCD display's standby screen. You can also do so by using the menu: **Media Center** → **Album**, or by using **Settings** → **Display** → **Wallpaper** → **Photo**.

- **Rename:** Give this photo a new file name.

 A photo's name can't be left empty, nor can it share the same name with another photo already stored in your phone.

- **Details:** Shows the photo's name, date, resolution, and file size.

Shortcuts Menu



You can use the Shortcuts menu to assign 8 alphanumeric keys as shortcuts to commonly used functions or frequently dialed numbers. The number 1 key has been assigned to voicemail dialing and you are not allowed to change it.

Entering the Shortcuts Menu

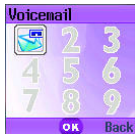

From the standby screen, press  to enter the Shortcuts menu. The numbers 2 to 9 displayed in the menu's default screen represent the corresponding 8 alphanumeric keys on the phone.





Setting Function Shortcuts

1. In the **Shortcuts** menu, press  to move the selection box to the number key you wish to use as a shortcut key ( is selected in the example on the right). You can also press the actual alphanumeric key  to select it.



2. Press  (**Option**) to bring up a pop-up menu, and use  to select **Add Function**. Then press .



3. From the **Add Function** menu, press  to select the function to be represented by the shortcut key , and then press . Alternatively, you can press a corresponding alphanumeric key to select the function you want.





The functions listed in the **Add Function** menu are selected from various other menus. For details on these functions, see page 70, "Menus".

Shortcuts

- 1 Add Phone Book
- 2 New Message
- 3 New MMS
- 4 Missed Calls
- 5 Received Calls

OK Back

4. After  has been set as the function shortcut key, the '2' icon in the shortcut menu screen will be replaced by the icon for the function assigned to . The top of the screen will display the name of the function currently assigned to this key.

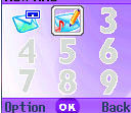

New MMS

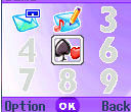

5. Repeat the above step to add or modify function shortcut key assignments.

Game



6. To cancel a shortcut key and restore the key's original function, use  to move the selection box to the icon for the shortcut key that you wish to cancel, and then press  (**Option**). Select **Delete** to cancel the shortcut.



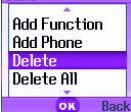

If you select **Delete All**, all shortcut settings will be cancelled.

Game



Setting Phone Number Shortcuts

1. The method for setting a phone number shortcut key is largely the same as for a function shortcut key. After selecting the shortcut key, press  (**Option**) to bring up a pop-up menu. After selecting **Add Phone**, press  to confirm.



2. From the Phone Book, select a contact, and then press .



3. Next, from the list of phone numbers for this contact, select the one that you wish to access through the shortcut key, and then press .

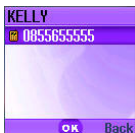

4. After you have set the shortcut key, the number icon for the key will be replaced by an icon representing a phone number shortcut. The upper part of the screen will display the name of the contact to whom the phone number accessible by the shortcut key belongs.

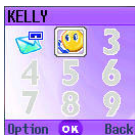







5. Repeat the above step to add or modify a phone number shortcut.

Different categories of phone numbers will be represented by different phone number shortcut icons.





Using Function and Phone Number Shortcuts

There are two ways to use shortcuts:



1. From the standby screen, long-press  to  to access the function represented by that key or dial the number it represents.
2. From the standby screen, press  to enter the Shortcuts menu. You can then:
 - a. Press  to move the selection box to the icon corresponding to the desired key. Then press  to access the assigned function or dial the assigned phone number.
 - b. Press the corresponding key  to  to access the function represented by that key or dial the number it represents.

Messages Menu

Your phone supports various messaging services including SMS (Short Messaging Service) and MMS (Multimedia Messaging service). SMS allows you to insert simple animations and ring tones into your short messages, while MMS enables you to send photos, colored images and music through your phone. You must have a subscription that supports MMS. Please contact your service provider for details.

From the standby screen, press  to enter the **Messages** menu. You can also press  when in the standby screen and then enter from the main menu by selecting  .

Additional information about messaging

- When a new message is received, or when there are unread messages in the phone's or SIM card's memory, the LCD display will show the  icon in its status bar to remind you that you have unread messages.
- When a message has arrived, it will be saved either to the the phone's memory or to your SIM card's memory, depending on the preferred memory you have selected in the menu: **Messages** → **SMS** → **Settings** → **Save Msg. to** (See page 51).
- If the LCD display shows a red icon  , this means that the SIM card's message memory is full. When the SIM card's memory is full, your phone will not be able to receive any new messages. The display will show a "Message capacity exceed" message.

The items in the **Messages** menu are as follows:



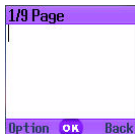

SMS

Editing and Sending a New Short Message

1. Go to menu: **SMS** > **New** to bring up the message editor so you can write a new short message. Use the alphanumeric keys to enter text.







-  For information on how to use the input methods provided by the phone for writing messages, see page 64, "Input Modes".

-  If no text has been entered in the editing screen, press  to return to the standby screen; if some text has been entered, pressing  will bring up the prompt "Cancel Message?", to make sure you wish to abort the message being edited. If you press  (**Yes**), you will return to the standby screen; if you press  (**No**), you can continue writing the message.





2. When writing a message, press  (**Option**) to perform the following tasks:

- **Insert:** You can insert the following types of objects:
 - **Text:** This is a list of templates that can be used instead of entering all the characters individually. You can use the factory default templates or templates of your own that you previously saved to the list.

-  To create your own quick message templates, go the menu **Messages** → **SMS** → **Templates**. See page 59.

- **Image:** You can select an animation from the image library to insert into your message. Press  to select image you wish to insert, press  once to preview and then press again to insert the image.
- **Melody:** You can select a ring tone from the melody library to insert into your message. Scroll to ring tone you desire, and then press  to insert the ring tone into your message. The inserted ring tone will be displayed as musical note within the message's text.
- **vCard:** You can select a contact's data from your Phone Book to attach to your message. After receiving your message, the recipient can save the attached contact data to their own Phone Book.
- **vCalendar:** You can select a Calendar memo and then attach it to your message. After receiving your message, the recipient can save this attached memo to their own Calendar.
- **Alignment:** Used to select the type of text alignment for the message's content.

3. After you have finished editing the message, press  and the following options appear:

- **Send:** Press  to enter a recipient's phone number editor. You may enter a phone number or press  (**Browse**) to select recipients from the list of contacts in the Phone Book. Follow the steps below:
 - a. Press  to scroll to the name of contact, and then press  to select it. Repeat the step to select multiple contacts.
 - b. Press  (**Done**) to return to the recipient's phone

number editor.

c. Press  to send.

 When a message is to be sent, a copy of the message will be saved to the Outbox folder. If the save fails, the "Save to Outbox Failed!" screen will appear and the send operation will stop.



- **Save to Draft:** Saves the message to the **Drafts** folder.
- **Discard:** Discards the message.

Receiving and Reading a Short Message





1. When you receive a new short message, the phone will play the alert sound and the message "1 New SMS" along with the sender's name will appear. If the sender is not stored in the phone book then only phone number will be shown.

2. Press  (**Option**) the following options appear:

- **New:** Allows you to write and send a new message.
- **Delete:** Delete the selected message.
- **Call Sender:** Uses the number from which the message was sent to call the sender.
- **Chat:** Starts a chat session with the sender.
- **Forward:** Forward the message to others and you may edit the content beforehand.
- **Save Sender Info:** Save the phone number from which the message was sent to the Phone Book.
- **Delete All:** Delete all messages in the Inbox.

3. Press  to read your message. Then press  (**Option**) the following options appear:

- **Reply:** Allows you to write and send a reply message.
- **Delete:** Deletes the message being read.
- **Call Sender:** Uses the number from which the message was sent to call the sender.

- **Chat:** Starts a chat session with the sender.
 - **Forward:** Forward the message to others and you may edit the content beforehand.
 - **Save:** Allows you to save the following content:
 - Save the phone number from which the message was sent (the number shown on the display in the "Sender Info" item) to the Phone Book.
 - Save the phone number displayed in the message's contents. (the option for a directly displayed number).
 - If the message has a picture or ring tone attached, you can save these objects to your phone's memory. Depending on the type of the object, the phone will save it to the corresponding category in the **Media Center** menu.
-  If you are saving an image or photo, you can select the **Save as Wallpaper** option, setting it as the wallpaper for the standby screen.
-  If you are saving a melody, you can also select the **Save as Ring Tone** option, setting it as the ring tone that will play when there is an incoming call.
-  If the message has a contact's information attached to it, you can save that contact's information to your Phone Book.
-  If the message has a Calendar memo attached to it, you can save that memo to your Calendar.
-  For details on the **Media Center** menu, see page 80.



Managing Outbox

Go to menu: **SMS > Outbox**. This option preserves a backup copy of messages that you previously sent. Scroll to the message and then press

 (**Option**) to delete, resend or forward the message. Select **Delete All** to erase all messages.



Managing Drafts

Go to menu: **SMS > Drafts**. This option allows you to preserve message drafts that you have saved. Scroll to the desired message record, and then you can:

- Press  (**Option**) to delete the draft or to delete all.
- Press  to edit the contents of the message.

Using the SMS Templates

Go to menu: **SMS > Templates**. You can use the quick message templates in this menu to compose a message without having to enter the entire text character by character. You can use the factory default templates, or templates that you previously saved to the list. Scroll to the desired template and then press  to insert its text into your message. You can then edit the text as you wish and then send the message.

To create your own quick message templates, press  (**Option**) and then select **Add**. You can then enter the text for the template, pressing  to save it.

 If a template is one of the factory defaults, you will not be able to use the editing function to modify it.

Cleaning Up Messages

Go to menu: **SMS > Cleanup**. This option allows you to cleanup part of or all of the messages. The options for cleanup includes All, Inbox, All Read, Outbox, and Drafts.

Settings

Save Msg. to

Here you can determine whether a new message will be saved to the phone's memory or to your SIM card's memory.

Service Center No.

This feature allows you to save the message center's phone number for sending your messages. The messages that you send are sent to recipients through this message center.

Enter the message number provided by the network vendor.

After you are finished, press  to confirm.

Bearer Mode

This can be set according to whether you are using a GPRS network system or a regular GSM dialup network. If you are using a GPRS network, you can use both the GPRS and dialup network to send and receive SMS messages. If however you are using a dialup network, you are restricted to using only the dialup network for sending and receiving SMS messages.

- **GPRS:** Use only the GPRS network to send and receive SMS messages.
- **CSD:** Use only the dialup network to send and receive SMS messages.
- **GPRS Preferred:** Use the GPRS network preferentially. Only if there is no GPRS network present will the dialup network be used.
- **CSD Preferred:** Use the dialup network preferentially. Only if there is no GPRS network will the GPRS network be used.

Validity Period

This sets the duration that an undeliverable SMS message that you send can be stored at the message center. During this period, the message center will continue to attempt to deliver the message to the designated number.

Message Type

You can request that your network operator convert your text messages to different types.

Status Report

After activating this function, the network vendor will report to you when a message has been delivered.

Direct Reply

You can request that your reply to an SMS be sent directly through the sender's message center.

MMS

 Before you start to use MMS, you have to subscribe to both GPRS and MMS services provided by your operator. Then you have to adjust MMS settings in your phone to be able to use MMS. Because MMS uses your operator's MMS server on a GPRS network to send messages to phones, you need to adjust the following settings correctly in order to use MMS:

Go to menu: **Oper.Service > WAP Service > WAP Setting** to create a new WAP profile for your network settings. See page 97, "WAP Settings" for details about how to set up a WAP profile.





Go to menu: **Message > MMS > Settings > Server Info** to select the MMS server for sending and receiving MMS messages.

 You should contact your operator for details on MMS settings. Some operators may adjust the settings for you after you subscribe to MMS.





Editing and Sending MMS Messages



Go to menu: **MMS > New**, and follow the steps below to write and send new MMS message.



1. Fill in below fields required for sending a MMS message.



- **To:** Press  to enter a recipient's phone number editor. You may enter a phone number or press  (**Browse**) to select recipients from the list of contacts in the Phone Book. Follow the steps below:
 - a. Press  to scroll to the name of contact, and then press  to select it. Repeat the step to select multiple contacts.
 - b. Press  (**Done**) to return to the recipient's phone number editor.



c. Press  to send.

- **Subject:** press  to enter the text for the subject.
- **Content:** press  to enter the slide editor. See below for details on the options of editing the content.
- **Cc:** You can send the message as a carbon copy to others.
- **Bcc:** You can send the message as a confidential carbon copy to others.
- **Priority:** press  to set the priority high, normal, or low for this message.
- **Receipt:** press  to choose from the following receipt modes:
 - **Both Delivery/Read:** Asks the recipient to return a confirmation after receiving and reading your message.
 - **Delivery Only:** Asks the recipient to return a confirmation after receiving your message.
 - **Read Only:** Asks the recipient to return a confirmation after reading your message.
 - **None:** Cancels this function.

2. To edit the MMS message content, scroll to the **Content** and then press  to enter the slide editor. Press  (**Option**) you can execute the following tasks:

- **Insert:**
 - **New Photo:** Brings up camera view finder for you to take a new photo. The photo can then be inserted into the current MMS slide afterwards.
 - **Photo:** You can select a photo saved in the Album to insert into a MMS slide. Press  (**Save**) to immediately insert the highlighted photo into current slide, or press  to view

the highlighted photo. Press  will display the next or previous photo. Press  again to save the photo into the slide.

- **Templates:** Insert the default MMS templates into your messages. Those templates contain images and text. You can customize those by inserting more objects you like.
- **Image:** You can select a image saved in the image library to insert into a MMS slide. Press  (**Save**) to immediately insert the highlighted image into current slide, or press  to view the highlighted image.
- **Melody:** You can select a ring tone saved in the phone to insert into a MMS page. Scroll to highlight the file name of the desired ring tone, and then press  to insert this ring tone to the MMS page.

 Each MMS page is only able to accommodate one image and one audio file. If you insert another image or audio file into the same page, the newly inserted file will replace the existing one.

- **Text:** Enter text templates into your message.
- **Slide Before:** Insert a new page before the current one.
- **Slide After:** Insert a new page after the current one.
- **Preview:** Plays all the slides in the message in sequence.
- **Remove Melody:** Remove the audio file on the current shown slide.
- **Remove Text:** Remove the text on the current shown slide.
- **Remove Image/Slide:** Remove the image if your message contains only one slide. Remove the current shown slide if your message contains multiple slides.
- **Previous/Next Slide:** Going to the previous or next slide.



- **Slide Duration:** To set the duration of each slide during playing. For example, 30 means each slide will played for 30 seconds.



Each slide allows only one image and one audio file. If you try to insert a second image or audio, an **Out of range** message will pop up.

3. After you finish all slides for a MMS message, press  (**Option**) and choose from the following options:
 - **Send:** Send the message immediately.
 - **Save to Draft:** Store the message in **Outbox**.
 - **Preview:** Preview the message.
 - **Discard:** Discards the message.

Reading an MMS Message

Having successfully downloaded the MMS message, the display will automatically switch to **Inbox**, press  to start playing the MMS message page by page. Press  again to stop playing. Press  (**Option**) to execute the following tasks:

- **Reply:** Reply to the sender.
- **Delete:** Delete this message.
- **Forward:** Forward the message to someone else.
- **Save:** Save the image shown on the slide or the sender information to your phone. After you save it, you can go to the menu: **Media Center** > **Image** to see it.
- **Save all:** Save the audio files and the images attached on the message to your phone.

Using the MMS Templates

These preset MMS templates contain images and text. Scroll to highlight the template you like and then press  to customize that template into your own MMS message.

Cleaning Up Messages

Go to menu: **MMS > Cleanup**. This option allows you to cleanup part of or all of the messages. The options for cleanup includes All, Inbox, All Read, Outbox, and Drafts.

Settings

Before you start to use MMS, go to menu: **MMS > Settings** to adjust the following settings:

Filter

Your phone will reject all MMS messages from the senders listed here.

Expiry

Sets the length of time your outgoing MMS message stays on the server before it reaches the recipient successfully.

Reply Type

You can determine here whether you want to use an SMS message or MMS message in reply to an MMS message you have received.

Size Limit

Sets the maximum size for a message that the phone receives. If an incoming message exceeds this size, the phone will not be able to download that message.

Server Info

Activates the MMS server used for sending and receiving MMS messages.

Deferred Download

After you activate this function, the phone will only download the information associated with the sender when it receives an MMS message. You can then decide whether to download this message's content after you have read the information related to the sender.

Delivery Report

Asks the recipient to return a confirmation after receiving your MMS message.

Read Report

Asks the recipient to return a confirmation after reading your message.

SMS Chat





You can engage in a peer-to-peer chat session by writing short messages to another mobile phone user. This feature allows you to have a continuous text conversation with someone without having to enter the number of the recipient each time you have something new to say. The text conversation is recorded so you can review what has been said in the chat session.

Starting a chat session

There are two ways of initiating a chat session.

1. Go to: **SMS Chat** → **Start Chat** to start a new chat session. Follow the steps below to conduct the chat:
 - a. Enter the nickname for the chat session, and press **OK**.
 - b. Enter the phone number of the person you want to chat with.
 - c. Write your message. When you finish, press **OK** to send the message to invite the recipient to a chat. The chat log shows

your nickname followed by your message as “nickname> message”.



- d. When the chat message is sent, press  (**Option**) and then choose **Send** to enter another message. The message will automatically be sent to the same recipient. Repeat the same process to send more messages to the same person.
2. Alternatively, to start a chat session, you can select a message from **Inbox**, press  (**Option**) and then choose **Chat**. Select a chat partner from the Nickname list and then press . Write your message and press  to send the message to invite the recipient to a chat.

Receiving a reply to your chat message



When your phone receives a reply from your chat partner, the chat log will show your partner’s name and message, followed by the previous message(s) you sent. You can now begin to chat with your partner.

Receiving a request for a new chat

When your phone receives a chat request from another person, a dialogue box would pop up on the display asking if you want to join the chat. Follow the steps below to reply to the chat message:

1. Press  to view the chat message.
2. Press  to join the chat. Enter your nickname and message, and press  to send your message.

Leaving a chat session

If you want to leave a chat session, press  (**back**) or . This will take you back to the **SMS Chat** menu. Your phone will keep the records of the last chat session. To resume the previous chat session, scroll to select **Previous Chat**. If you want to start a new chat, go to: **SMS Chat** → **New Chat**.

When you are interrupted by an incoming call during a chat session

1. Answer the call. Upon ending the call, the display returns to the idle mode. Then you may resume the chat session by selecting **Previous Chat** from the **SMS Chat** menu.
2. Reject the incoming call and continue the chat by selecting **Previous Chat** from the **SMS Chat** menu.

Voice mail

Get Voice mail

Used to dial the voicemail number provided by your network vendor to listen to your voicemails.

Set Number

You can save your voicemail phone number here.

-  Your network vendor will provide you with your voicemail inbox number and a number for accessing any other voicemail services. For detailed information about voicemail services, contact your network operator to see if you need to save a specific phone number to your phone in order to access your voicemail inbox.

Cell Broadcast

Cell broadcast messages are general messages that your network operator broadcasts to all phones within a particular area. These messages are broadcast in numbered channels. For example, channel 030 might be for local weather, 060 for traffic reports, 080 for information about local hospitals, taxis, pharmacies, and so forth.

You can receive cell broadcast messages that your network operator broadcasts, and select your preferred topics and languages.



For more information about available channels and a list of the information they provide, contact your network operator.



When you receive a cell broadcast, the content will be displayed twice in ticker-tape fashion.

Receive

Allows you to select whether or not to receive cell broadcast messages.

Topics

Allows you to decide what information you wish to receive from your network operator's cell broadcasts. The topics listed in the **Topics** list represent the broadcast information that you have selected to receive from your network operator.



If you have not previously saved any topics, you can press



(Option) and then select the **Add** option so that you can enter the desired range of topic numbers (that is, the channel numbers). The upper and lower limits of the range are the highest and lowest channel numbers, respectively. The largest

possible range is 0 to 65534. You are no longer limited to selecting only single channels, but can specify a range. After the list has stored the topic range, you can select a specific topic and then press  (**Option**) to add it to the list. You can also edit or delete selected topics.

Language

You can limit the cell broadcast information that you receive from your network operator to a specific language. Press  (**Select**) to select your preferred language, and then press .

Memory Status

Displays the amount of remaining available memory, including pictures, animations and ring tones stored on the phone.

Input Modes

Changing the Text Input Mode

When the display shows the editing screen, you will be able to see the name of the current text input mode in the upper right corner of the screen. Press  to change the input mode.

The text input mode currently in use



Name: RACHEL ABC

OK Clear

The input mode icons (names) that may appear in the upper right corner of the screen represent the following input modes:



Uppercase letters input mode.



Lowercase letters input mode.



iTap (predictive input mode) for uppercase letters.



iTap (predictive input mode) for lowercase letters.



Numeric input mode (123).







You can set the default input mode to the one you most frequently use. Go the menu **Settings** → **Input Mode**. See page 119.

Letter Input Mode (ABC)



In this mode, press the key containing the desired letter repeatedly to scroll through the available characters in order until it is reached.

How to use the letter input mode

- You must press the key corresponding to the desired letter the correct number of times in order to enter the letter you want. Display letters for entry according to the order shown on each key. Pressing a key once will display the first letter listed on the key, while pressing it twice will display the second letter, and so on.
- When you have entered a letter and wish to enter the next letter, either wait for two seconds until the cursor moves to the next text entry position, or immediately press the key for the next letter.
- Press  to enter a space before beginning a new word.
- While entering text, press  to move the cursor left or right; press  to move the cursor up or down. Press  once to delete a character; long-press  to delete all entered content.

Numeric Input Mode (123)







The numeric input mode allows you to use the alphanumeric keys

 to  to enter numbers.

Predictive Input Mode (iTap)











iTap analyzes letters as they being inputted, making intelligent predictions about the words you are attempting to enter, and speeding up text entry.



How to use iTap

- Press once the alphanumeric key corresponding to the first letter of the word you wish to enter without considering where that letter falls in the sequence of characters available through that key. Then press the key corresponding to the second letter, and so forth. The phone will predict which word you wish to enter based on the set of keys you have pressed. The predicted word will be shown in the lower left portion of the screen. This word may change as you continue to press other keys; therefore, before you have entered a complete word, you do not need to worry if the displayed word does not yet match the word you intend to enter.
- After pressing keys for a complete word, if the displayed word does not match the one you intended to enter, press  to view other candidate words and locate the desired word.
- Once the correct word is displayed on the screen, press  to enter this word. A space will automatically be inserted after the word.
- While entering text, press  to move the cursor left or right; press  to move the cursor up or down. Press  once to delete a character; long-press  to delete all entered text.



Example of iTap in use

To enter "COME HOME" in the message editing screen using iTap, use the following steps:

1. Press  to switch to iTap for uppercase letters (ITAP).
2. Press     to select C, O, M, E.
3. Press  to enter "COME" as text. A space will automatically be inserted after "COME".
4. Press     to enter "HOME".



5. Since "GOOD" is not the word that you wish to enter, press  to display the next candidate word, "HOME".
6. Press  to place "HOME" into the message.

Symbol Input Mode



When editing messages, press  to open the symbols field along the bottom of the screen. Use  to move the selection box to the symbol you wish to enter, and then press  to place it in the message text.

Direct Connection to URLs



Your phone provides handy preset URL text hotkeys, enabling you to enter a complete URL more quickly and conveniently, and making Internet access more efficient and enjoyable.







From the standby screen, you can rapidly key in numerical URLs. If, for example, you wish to enter "http://123.com" you need only key in "123" and then press . The full URL will appear on the screen.  automatically adds the necessary "http://" prefix and the ".com" domain suffix. To actually connect to this website, simply press  to confirm and the phone's browser will be started up so that you can get online.

When entering a URL, you can also use  to access the following functions:

- After pressing  once, further presses of  will switch to the URL suffixes shown in the chart:

Number of times	Output result
0	.com
1	.com.tw
2	.net
3	.net.tw
4	.com.cn
5	.net.cn

- You can convert  (*) into the (.) that appears in URL addresses. For example, if you enter 123*456 in the standby screen, and then press , the URL "http://123.456.com" will appear on the screen.

- After you press  to enter "http://" press  to enter "/" and "-". For example, if after you enter "123" and then press  once-causing "http://123.com" to appear on the screen-you press  again, the URL will change to "http://123.com/". Pressing  again will switch between "/" and "-".
- When the screen shows the desired URL, press  to connect to the Internet and access this URL address.

4 Menus

The phone's menus provide various features. The main menu consists of 9 icons. Each icon represents a particular menu item, which is used to access related sub-menus.

For information about navigating menus, see page 15, "Menu Navigation".



Phone Book

This menu provides various functions for managing the Phone Book, including the ability to add, locate, and copy contact data; add contacts to a caller group; and so forth.

Find

Used to locate a contact in the Phone Book. You can enter the full name of the desired contact, or if you are not sure about the spelling of the contact's name, simply enter the first letter, and then press **OK**. The phone will locate all contacts whose names begin with this letter, and you can scroll to the field containing the contact you want. For details on what to do after locating the desired contact, see page 29, "SIM Card Phone Book".

Add

Used to add a new contact to the Phone Book. You will be prompted to select from **To SIM** or **To Phone**. Select **To SIM** the contact will be saved on your SIM memory, and select **To Phone** the contact will be saved on the phone. You can follow the procedure described on page 26, "Adding Contacts to the Phone Book".

Edit

After selecting a particular contact, you can follow the procedure described on page 26 for editing the data for this contact.

Copy

If you are using the phone book stored in the phone's memory, you can copy contact data to the SIM card's phone book, and vice versa. You can select a contact to copy from one phone book to the other, and copy all contacts in one phone book to the other by choosing the option **All Phone to SIM (All SIM to Phone)**.

Delete

Deletes a contact from the Phone Book. You can delete one contact at a time, or delete all contacts at once.





Caller Group

Caller groups are combinations of phone settings used to identify a particular group of contacts, such as work colleagues, family members, or friends. For example, you can associate a ring tone and animation with one group, and when a member of that group calls, the phone will use the group's ring tone and display its animation.

The phone provides 5 caller groups: **Colleagues, Family, Friends, VIP, Others**.

After you scroll the caller group that you wish to configure, you can perform the following tasks:

- Press  (**Option**): Used to select the ring tone or image ID that will help you identify the caller group to which a particular caller belongs, or to rename the caller group.

- Press  : Allows you to view a list of all contacts that belong to the caller group. Press  to highlight the desired contact, and then press  (**Option**) to access the following options:
 - **Add**: Add a contact to the caller group. Press  to select a contact to add, and when finished press  .
 - **Delete**: Deletes the selected contact from the contact group.

Business Card

You can use this option to enter your own business card information. The data fields are as follows:



Your name.



Your mobile phone number.







Your e-mail address.



Your company's address.





Your job title.

Press  to scroll to the data field you wish to edit, and then press  to begin entering the text. After you are finished entering the data, press  to return to the previous screen. Press  (**Option**) and select **Save** to save all the business card data, or select **Send vCard** to send this business card as an attachment in a short message.

My Number

This option allows you to save your SIM card number and name to your SIM card's memory.

Press  (**Option**) and select **Add** to enter your name and number.

When you are finished, press  (**Option**) and then select **Save** to save your data. If you wish to edit the current name and number, press

 (**Option**) and select **Edit** to edit the currently selected data.

Memory Status

Shows you the entries that have been stored and the maximum entries that can be stored, on the SIM and on the phone.



Call Records

 Your network operator must support this feature in order for you to be able to use it.

This menu includes a list of your missed calls, dialed calls, and received calls. Call costs and time are also recorded.

Missed Calls

Shows your most recent missed calls.

Press  to scroll to the missed call that you wish to select. You can now choose to view, edit, or delete the number for the missed call. The procedure is the same as that described on page 32, "Last Missed, Dialed, and Received Calls".

Received Calls

Shows your most recent received calls.

The procedure for using this feature is the same as that described on page 32, "Last Missed, Dialed, and Received Calls".

Dialed Calls

Shows your most recent dialed calls.

The procedure for using this feature is the same as that described on page 32, "Last Missed, Dialed, and Received Calls".

Cleanup All

Deletes all call records.

Call Duration

 This feature is only accessible if supported by your network operator.

Last Call Time

Shows the duration of the last call.

All Calls Time

Shows the total time for all calls.

Received Calls Time

Shows the total time for all received calls.

Dialed Calls Time

Shows the total time for all dialed calls.

Reset

Clears all call time records.

 You must enter your PIN2 code in order to zero call times.



What is a PIN2 code?

- The PIN2 is the second PIN code. Its main use is in controlling restricted services—for example, call time limits and restricted phone numbers.
- If the PIN2 code is incorrectly entered three times consecutively, the PIN2 code will be locked. To unlock the PIN2 code, you will need to enter the PUK2 code, which you obtain from your network operator.

Call Cost

Last Call Cost

Shows the cost of your last call.

 Requires the support of the network operator.

All Calls Cost

Shows the total cost of all calls.

 Requires the support of the network operator.

Reset

Clears all call cost records.

 Requires entry of the PIN2 code.

Call Cost Limit

Shows the current limit set for total call costs.

Set Call Cost

Allows you to first enter the unit price and a currency for calculating call costs.

 Requires entry of the PIN2 code.



Messages

For a description of the features available in the messages menu, see page 46, "Messages Menu".



Games

Your phone provides a number of exciting games that you can use to entertain yourself when you have a spare moment.

Games

Cherry Boy

This game contains five levels and in each level the player has three lives. To pass one level you must collect all the cherries before time is up, or you must obtain the key to the next level. If you bump into a monkey, you lose one life. Press **OK** to begin a new game. Press **←** to scroll to the menu item you want.





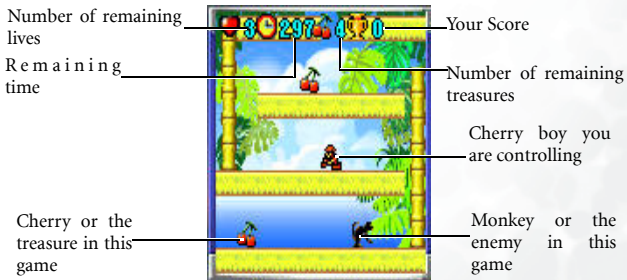

Game screen



Game controls



Press  or  to move the player left or right.

Press  or  to move the player up or down on a ladder. Press  to pause the game.



Press  to split the path so the monkey will fall. The split will be reconnected in 5 seconds.

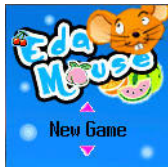

Eda Mouse

This game contains eight levels and to pass each level player has to eliminate the fruit to a certain amount. You pass one level when your score has reached a thousand points. To eliminate the fruit, player has to arrange three identical fruit in a row. You lose the game when the fruit reach the eda mouse's head.



Mixed sorts of fruit.

The vertical dotted line indicates the path you aim at the target.

Press  or  to move the eda mouse left or right.

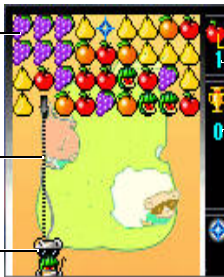



Level

Your score

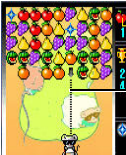

For example, press  once to collect one apple, and press twice to collect two apples. You can only collect up to three and they have to be the same kind.



Press  three times to move the mouse to the right by three lines. Then press  to release the two apples that you collected. The apples on the vertical line are now eliminated.



Camera

The digital camera function you access through the main menu is the same as pressing  (**Camera**) from the standby screen. For details on how to use the camera to take photos, see page 39, "Camera Function".



Media Center

Album



This album stores the phone's default pictures, as well as images received in MMS messages, or photos taken using the camera on the phone.

After entering this menu, the photos will shown as thumbnails on the left, and on the right side of each thumbnail you will see some details associate with that photo.

- The date when the photo was taken: Shown as "yyyy.mm.dd".
- The photo's resolution: Shown as "width x height".
- The photo's file size: Shown as "xxx KB".

Steps for handling photos are as follows:

Scroll to the desired picture to access the following options:

- Press  to display this picture. Pressing  will display the next or previous picture.
- Press  (**Option**) to perform the following tasks with the picture:
 - **Delete:** Deletes the picture.

- **Set Image ID:** Set the current selected photo as a phone book contact's visual caller ID. When there is an incoming call from that contact, the phone's display will show this photo.
 - **New Entry:** Enables you to create a new contact in the Phone Book using the photo as her/his caller ID.
 - **Exist Entry:** Associate the current selected photo with a contact in the phone book entries.
 - **Set Wallpaper:** Use the picture as the wallpaper for the standby screen.
 - **Send:** Sends the picture in a MMS message.
-  For information about messaging features, see page 46, "Messages Menu".
- **Rename:** Allows you to provide the picture with a new name.
 - **Delete All:** Deletes all the photos in the album.
 - **Details:** Shows the name of the photo, the date it was taken, and the size of the image.

Image

This image library stores the phone's default images, as well as images received in messages, downloaded through WAP services or using multimedia communications tools. You may set the image as caller ID image, or send the image in a short message.



The file formats supported by the phone are BMP, PNG, GIF, JPEG (progressive or arithmetic-encoded saves not supported), and EMS picture.

Melody

This ring tone library includes the phone's default ring tones, as well as ring tones received in messages, or downloaded through WAP services or using multimedia communications tools.



The phone supports the following music file formats: MIDI, SMAF, and iMelody.

Scroll to the desired ring tone, and press  (**Option**) to perform the following tasks with the ring tone:

- **Set Ring ID:** Set the current selected ringtone for a contact. When there is an incoming call from the contact, the phone will play this ring tone.

- **New Entry:** Enables you to create a new contact using the current selected ringtone.

- **Exist Entry:** Associate the current selected ringtone with a contact in the phone book entries.

- **Set Ringtone:** Makes the ring tone the alert sound for incoming calls.

- **Rename:** Allows you to give a new name to the ring tone.



The phone's default ring tones cannot be renamed, so they do not present this option.

- **Delete:** Deletes user-defined ring tones.



The phone's default ring tones cannot be deleted. Only user-defined ring tones provide this option.

- **Send:** Sends the ring tone in a message.



For information about messaging features, see page 46, "Messages Menu".

- **Details:** Displays the name of the ring tone, its file size, and whether it is a default ring tone, or a file that you have saved or downloaded yourself (noted as **User Defined**).

Cleanup All

Deletes all the data stored in the media center.

Memory Status

Displays the amount of remaining available memory, including photos, images, and ring tones stored on the phone.



Tools

Alarm



If you activate the Alarm Clock feature, when the specified date and time arrive, the phone will sound the alarm, even if your phone is turned off.

1. Select the alarm you wish to set and press .
2. The status of the alarm will appear, press to set the alarm status on or off.
3. After your alarm is turned on, setting options appear as shown in the chart below:



Switch the alarm on or off.



Enter the time when an alarm will go off.

Use to set the alarm mode:





- **Once:** Alarm will go off only once.
- **Daily:** Alarm will go off daily.
- **Weekday:** Alarm will go off Monday through Friday.



Allows you to select the length of the alarm. Press to select the desired alarm duration.



Set the ring tone for the alarm. Press (Set) and then select the desired ring tone.

4. Lastly, you must press  (**Save**) to save all your current Alarm settings. After completing Alarm settings,  will appear in the standby screen's status bar.

World Clock

If during travel, you move between time zones, the phone will automatically adjust the time displayed on the screen based on the time zone prompts provided by the local network operator so that you always have access to accurate local time.

On

The time displayed on your phone will be reset automatically according to the local network operator's time zone prompts.

Off

You phone will display the time you have set, and when you travel to other time zones, the phone will ignore time zone prompts issued by the local network operator.

Confirm First



The phone will ask for your confirmation before it resets its time.

Calendar

You can use the Calendar to set up memos for forthcoming events such as a meeting, an appointment, or a friend's birthday. The Calendar will also remind you about events you have previously scheduled.

1. When you open the Calendar, the phone will show the calendar for the current date.

 If you have not set the current date on your phone, go the menu **Settings** → **Date & Time**. See page 104 .

In the Calendar screen, press  to move the red box to the date where you wish create a memo. You can also press  (**Option**) and select the **Go to Today** option.

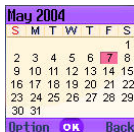

When the Calendar is opened, the current date will be highlighted by a red box.

2. When the red box is highlighting the desired date, press  (**Option**) and select the **Add** option to open the memo editor.

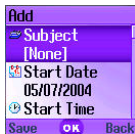

3. In the memo editor screen, scroll to the data field you wish to edit, and then press , or press alphanumeric keys to begin entering data. You can enter data in these fields:

 Enter the subject for the event.

 Enter the start date of the event.

 Enter a start time of the event.



Enter the end date of the event.



Enter an end time of the event.



This option allows you to set the time you want the reminder to remind you about the event. For example, if you want the reminder to sound 30 minutes before the meeting, chose **30 minutes** to set the reminder to do so.



This option allows you to set the reminder repeatedly to go off. For example, if a meeting is held every Thursday starting 2004/08/05, you may select 2004/08/05, and then chose **Weekly** to set the reminder to go off on Thursdays beginning with 2003/08/05.



Enter a location for the event.



Enter the names of the participants in the event.



Record any notes about the event.

4. After completing entry of data in each of the fields, you must press  (**Save**) to save the memo to that date.

Shortcuts

For a description of the features accessible through the Shortcuts menu, see page 42, "Shortcuts Menu".

Calculator

Allows you to use the phone as a calculator. Use  to perform the mathematical operations shown on the screen.

 You can enter numbers up to a maximum of 8 digits in length.



Entered numbers and calculation results will appear in this field.

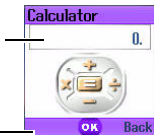

Press  to enter a decimal point.





Currency Converter

Below is a description of the Currency Converter screen:

1. To set the currencies for conversion, press  (**Option**) and select either **Currency 1** (to set the currency at the top of the screen) or **Currency 2** (to set the currency at the bottom of the screen), then press  to confirm. After selecting a currency from the list, press .
2. Used to set the exchange rate.

Press  (**Option**) and select **Rate Setting**, then enter the rate for converting from Currency 1 to Currency 2. The conversion calculation result will be displayed in the same line as the bottom currency on the screen. Use the  to view the calculation result. The calculation can provide precision up to two decimal places.

 The exchange rate field can accommodate a maximum of five digits (including decimal digits).

 Press  to enter a decimal point.

3. After returning to the Currency Converter screen, you can select one of the currencies and then enter an amount that you wish to convert into the other currency.





 You can enter amounts up to six digits long.

4. After pressing  the converted amount will appear in the field for the other currency.



Stopwatch

1. Press  to start the stopwatch.
2. While the stopwatch is running, you can press

 (**Split**) to save up four elapsed times (such as in a race). The display will show the saved times in the lower part of the screen.

 Pressing  (**Back**) while the stopwatch is running will bring up the "Quit?" warning message (the stopwatch will continue to run). Press  (**Yes**) to stop the stopwatch or  (**No**) to return to the timer screen.



3. Press  to halt the stopwatch.
4. Once the stopwatch is halted, press  (**Reset**) to zero the stopwatch.



Oper. Service

Your phone includes a built-in WAP browser, allowing you to use the phone for mobile Internet connectivity. You can browse the online services offered by the network operator or ISP, such as information on financial news, sports, travel, and entertainment. To use the phone to get online, necessary WAP and GPRS settings must be made in this menu.



You must apply to a network operator for WAP services and complete WAP and GPRS settings in this menu before you will be able to take advantage of mobile Internet connectivity. In general, once the service you have applied for has been activated, the network operator will automatically transmit the needed settings to your phone. If this is not the case, you must perform this configuration yourself. For information about WAP and GPRS services and configuration details, contact a network operator providing these services.

WAP Service





Your phone provides the following methods for activating the browser and getting online.

1. From the standby screen, activate the browser and get online by using the feature that allows you to connect directly to URLs. For details, see page 68, "Direct Connection to URLs".
2. Activate the browser from the three options in the menu **Oper. Service** → **WAP Service**:
 - **Start Browser**: Starts up the browser and connects to the homepage.
 - **WAP Message**: Starts up the browser and accesses the WAP inbox for reading text messages.
 - **Goto URL**: Starts up the browser and connects to the URL that you enter.



Start Browser

Starts up the browser and connects to the homepage.



Browsing a webpage

Referring to the soft key commands at the bottom of the screen, press  and  to perform needed tasks while browsing a webpage. Press  to scroll up or down a webpage. For details on browsing a webpage, inquire with the network operator providing WAP services. Your Internet connectivity service will determine the layout and content of the webpages you view. Depending on the specifics of your service, the way you browse the Internet on your phone will differ.

How to close the browser and end the online session

- While online, press  or long-press .
- If you are already viewing a WAP webpage, long-press  or from the browser's menu select **Exit**.

How to display the browser's menu

While viewing a WAP webpage, press  to display the browser's menu. Referring to the soft key commands at the bottom of the screen, press  and  to access the various options. Press the corresponding alphanumeric keys to directly select an option. The browser menu contains the following items:

Back

Selecting this option will take you to the page you viewed previously.

Home

Returns to the home page. To designate a particular page to be your home page, go to **9 Settings** → **1 Homepage**.

Exit

Closes the browser and returns you to the main menu screen.

Inbox



When your phone receives a message that can only be viewed using a WAP browser, you enter this WAP inbox to read the message.

Bookmarks

You can open the Bookmarks menu and select webpage bookmarks.

View

Allows you to see the current bookmarks and bookmarks folders. Scroll to the desired bookmark or bookmarks folder, and you can:



- Press  (**Go**) to link to the webpage that the bookmark represents. If you have selected a bookmarks folder, select the desired bookmark from within the folder, and then press  (**Go**).
- Press  (**Menu**) to display the following options:
 - **Details:** Displays the bookmark's title and the URL it represents.
 - **Delete:** Deletes the bookmark or bookmarks folder.
 - **New Bookmark:** Creates a new bookmark.
 - **New Folder:** Creates a new bookmarks folder.

- **Move to Folder:** Moves a bookmark to the designated folder.
- **Delete All:** Deletes all bookmarks and book-marks folders.
- **Hotkeys:** Allows you set a numerical key as a hotkey for a bookmark. After completing the setting, you can press this numerical key to directly link to the webpage represented by the bookmark.

Mark Site

Adds the current webpage to your bookmarks list.

GoTo URL

Press  (**Edit**) and enter the URL of the webpage that you wish to browse, and then scroll to the **Go** option and press  (**Go**) to link to that URL.

Save Items

When viewing a webpage, if you discover that it contains an image that can be downloaded, you can access this option to save the image to your phone. Subsequently, this image will be available for use when you are composing messages or choosing a standby screen wallpaper.

Reload

Reloads the current webpage.

Settings

You can enter this item to making the following settings:

 For detailed information about the following settings, contact your ISP.

Homepage

Designates a homepage. When you start up the WAP browser or if you select **Home** from the browser's menu, the screen will display the homepage you designate.

- a. Press  (**Edit**) and then enter the URL of the webpage that you wish to use as your homepage. (Some WAP service providers do not allow users to set a homepage.)
- b. Select the **Save** option to designate the URL you entered as your homepage. Select **Use Default** to use the homepage designated by your WAP service provider.

Scroll Mode

You can select two scrolling modes: **Block** or **Smooth**. In the Block mode, as many words as will fit in a line are shown for a few seconds, then the next line is shown, and so on. In the Smooth mode, the content scrolls smoothly on the screen. You can also adjust the scrolling speed: **Fast**, **Medium**, **Slow**.

Send Referrer

This option allows you to determine whether the browser will send an HTTP referrer header.

Key Press Timeout

This option sets the amount of time that the phone waits during text entry before automatically advancing the cursor to the next entry position. As long as the same key is re-pressed within the interval of time set here, it will continue to cycle through the characters available through that key.

Set Proxy

Your phone can save the settings for six WAP proxy servers. You can select one of these proxy settings for use as a default so that your phone will connect to that proxy server when you begin an Internet session.

You can also go to the menu **Oper. Service** → **Wap Service** → **Wap Setting** to select the server that you wish to activate. See page 97.

Circuit Prompt

The Circuit Prompt is a message displayed before each circuit data call is made. It reads, "Circuit is down. Start a data call?" You can choose to enable or disable this feature.

Security

Secure Prompt

The Secure Prompt message is displayed before you leave a secure area. It reads, "Entering a non-secure area. OK?" You can choose to enable or disable this feature.

Current Certificate

Displays information on the certificate currently in use.

CA Certificates

Displays information on the built-in certificate. A certificate is a digital ID issued by a trusted third party known as a certificate authority (CA). The phone uses CA certificates to authenticate websites that send information to the phone.

Authentication

You can decide whether your phone should store your user name and passwords for websites that require them. If you allow your phone to authenticate you automatically, you will not need to re-enter your user name and password each time you visit the same website.

Advanced

Restart Browser

Restarts the browser, and automatically returns to the designated homepage. This feature is provided for your convenience if network errors occur, allowing you to restart the browser and re-establish your Internet connection.

Downloads

If this option is enabled, you will not be able to download images, background audio, and objects.

View Title Region

You can choose whether or not to have the browser display webpage titles. You can also set this option so that titles exceeding a certain length will be split into separate lines. (The first line of the browser displays a "G" and a globe image, while the second is the "title region". The actual webpage content begins on the third line.)

About...

From here, you can view information about the version of the browser that you are using.

WAP Message

When you receive a new WAP message, the status bar will show the  icon to remind you that you have an unread WAP message. Starts up the browser and displays the WAP inbox so you can read WAP messages.

Goto URL

Enter the URL of the webpage that you wish to browse, and then scroll to the **Go** option and press  (**Go**) to link to that URL.

Resume

Returns to the last webpage you viewed.



WAP Settings

In this menu, you can make settings for the WAP servers of six different network operators, and select the server that you would like to use when connecting to the Internet.

The first time that you start your phone after inserting a SIM card, the ISP name of the network operator issuing the SIM card will appear in this menu's first group of settings. This indicates that your network operator's WAP server settings will be saved under the name shown. The phone will activate this group of settings for use in connecting to the Internet.

To activate another set of WAP server settings, scroll to the group of settings you wish to use and then press . The phone will activate these settings for use in connecting to the Internet.

By scrolling to a particular group of WAP server settings that you wish to modify, and then pressing  (**Option**), you can create a new group of settings, edit the settings, or delete the settings.



WAP server settings include the fields listed below. Press  (**Edit**) to edit the setting in each field. When you are finished with the settings for all fields, you must press  in order for this group of WAP server settings to be saved.

- **Profile Name:** Gives the WAP server settings a name.
- **Homepage:** Sets the webpage that the browser will link to when it is started up. After you enter this item, key in the URL for the webpage that you would like to use as the homepage — for example, <http://wap.yahoo.com>.
- **IP Address:** Enter the IP address used for accessing the mobile Internet.
- **Port:** Enter the connection port specified by the network operator — for example, 9201.
- **Bearer Mode:** Before connecting to the Internet, you must set this item according to whether your Internet connection bearer mode is a GPRS network system or a GSM dialup network. Doing so will allow you to properly link to the data network to browse WAP pages, download Java programs, and so forth. If you are using a GPRS network, you can use both the GPRS and dialup network to connect to the Internet. If, however, you are using a dialup network, you are restricted to using only the dialup network to connect to the Internet.
 - **GPRS/CSD:** Use the GPRS network preferentially. Only if there is no GPRS network present will the dialup network be used.
 - **GPRS:** Use only the GPRS network.

- **CSD/GPRS:** Use the dialup network preferentially. Only if there is no dialup network will the GPRS network be used.
- **CSD:** Use only the dialup network.



A dialup network is a GSM Circuit Switch Data Service (CSD for short). Using a dialup network can be likened to using a home computer's modem, in that before connecting to the Internet a number must be dialed. As for GPRS, it like the LANs used at company, where users do not need to dial a number to access the network. Regular GSM users who are not using a GPRS network system can only have a dialup connection to the Internet.

- **GPRS:** To modify settings for a GPRS account, press  (**Edit**) to edit the settings in each field. GPRS settings include the following fields:
 - **APN:** Enter the APN (Access Point Name) assigned by your network operator.
 - **User Name:** If needed, enter the user name provided by your network operator.
 - **Password:** If needed, enter the account password provided by your network operator.
- **CSD:** If you are using a GSM network, you must configure and activate a CSD account. Press  (**Edit**) to edit the settings in the following fields:
 - **Dial Number:** When you start up the browser to connect to the Internet, you phone will dial this number. Your telecoms network operator or ISP will provide this number to you.
 - **User Name:** This is your user account name, and is provided by your network operator.
 - **Password:** The account password provided by the network provider.

- **Line Type:** This is the type of dialup connection. Press  to select.
- **Baud Rate:** The default value is 9600, which is the standard speed for data connections with a GSM mobile phone.
- **Auth Type:** This is information needed for telecommunications protocol authentication.

Save Items

When viewing a webpage, if you discover that it contains an image that can be downloaded, you can access this option to save the image to your phone. Subsequently, this image will be available for use when you are composing messages or choosing a standby screen wallpaper.

Reload

Reloads the current webpage.

Settings

You can enter this item to making the following settings:

 For detailed information about the following settings, contact your ISP.

Homepage

Designates a homepage. When you start up the WAP browser or if you select **Home** from the browser's menu, the screen will display the homepage you designate.

- a. Press  (**Edit**) and then enter the URL of the webpage that you wish to use as your homepage. (Some WAP service providers do not allow users to set a homepage.)

- b. Select the **Save** option to designate the URL you entered as your homepage. Select **Use Default** to use the homepage designated by your WAP service provider.

Scroll Mode

You can select two scrolling modes: **Block** or **Smooth**. In the Block mode, as many words as will fit in a line are shown for a few seconds, then the next line is shown, and so on. In the Smooth mode, the content scrolls smoothly on the screen. You can also adjust the scrolling speed: **Fast**, **Medium**, **Slow**.

Send Referrer

This option allows you to determine whether the browser will send an HTTP referrer header.

Key Press Timeout

This option sets the amount of time that the phone waits during text entry before automatically advancing the cursor to the next entry position. As long as the same key is re-pressed within the interval of time set here, it will continue to cycle through the characters available through that key.

Set Proxy

Your phone can save the settings for six WAP proxy servers. You can select one of these proxy settings for use as a default so that your phone will connect to that proxy server when you begin an Internet session.

You can also go to the menu **Oper. Service** → **Wap Service** → **Wap Setting** to select the server that you wish to activate. See page 97.

Circuit Prompt

The Circuit Prompt is a message displayed before each circuit data call is made. It reads, "Circuit is down. Start a data call?" You can choose to enable or disable this feature.

Security

Secure Prompt

The Secure Prompt message is displayed before you leave a secure area. It reads, "Entering a non-secure area. OK?" You can choose to enable or disable this feature.

Current Certificate

Displays information on the certificate currently in use.

CA Certificates

Displays information on the built-in certificate. A certificate is a digital ID issued by a trusted third party known as a certificate authority (CA). The phone uses CA certificates to authenticate websites that send information to the phone.

Authentication

You can decide whether your phone should store your user name and passwords for websites that require them. If you allow your phone to authenticate you automatically, you will not need to re-enter your user name and password each time you visit the same website.

Advanced

Restart Browser

Restarts the browser, and automatically returns to the designated homepage. This feature is provided for your convenience if network errors occur, allowing you to restart the browser and re-establish your Internet connection.

Downloads

If this option is enabled, you will not be able to download images, background audio, and objects.

View Title Region

You can choose whether or not to have the browser display webpage titles. You can also set this option so that titles exceeding a certain length will be split into separate lines. (The first line of the browser displays a "G" and a globe image, while the second is the "title region". The actual webpage content begins on the third line.)

About...

From here, you can view information about the version of the browser that you are using.

Clear Cache

Clears webpage content that the browser temporarily stores in memory.

Clear URLs

Clears URL strings that the browser temporarily stores in memory.



Settings

Date & Time

Used to set the time and date, as well as the format in which the time and date will be displayed on the startup screen. Press  to save the settings.

Date

Enter the date using appropriate number keys.

Time

Enter time using appropriate number keys.

Format

This option is used to decide the format in which the time and date will appear in the standby screen.

Auto Power On/Off

Designates a time for the phone to be automatically turned on or off. If this option is activated, the phone will be automatically turned on or off at the designated time each day.



When riding in an airplane or in any other situation where you cannot use a mobile phone, remember to deactivate the Power On/Off option.

Power On



When you see **Status Off** displays on the screen, press  and choose the **On** option, scroll to **Time** and then enter a time you wish the phone to be auto turned on.

Power Off

When you see **Status Off** displays on the screen, press  and choose the **On** option, scroll to **Time** and then enter a time you wish the phone to be auto turned off.

Profiles

A profile is a group of settings that determine whether the phone will alert you to incoming calls through a ring tone or a vibrating alert, and how ring tones in general are used on the phone. These settings allow the phone's operation to best suit the environment you are in.

1. Press  to scroll to the desired profile and then press  to activate this profile. You can choose from among the following profiles:

Normal

This is the default profile. Once this profile is activated, the LCD display's status bar will show the  icon.

Meeting

The options in this profile have been preset to suit a meeting environment (for example, only a vibrating alert is used, with no audible ring tone and no keypad tones). Once this profile is activated, the LCD display's status bar will show the  icon.

Silent

The options in this profile have been preset for occasions where silence is required (for example, there will be no audible ring tone, no keypad tones, and no vibrating alert). Once this profile is activated, the LCD display's status bar will show the  icon.

Outdoors

The options in this profile have been preset to suit an outdoor activity (for example, use of the highest ring tone volume, activation of both ring tone and vibrating alerts, and use of keypad tones). Once this profile is activated, the LCD display's status bar will show the .

Handsfree



This profile is only active when a hands-free kit is attached to the phone. Once this profile is activated, the LCD display's status bar will show the .

Airplane

When you are on a plane, you can select this profile to turn off the phone. Once this profile is activated, the phone will automatically be powered off, and all alarms will be suspended. If the phone is turned off by long-pressing , the alarms will still go off at the appointed times.

Personal

You can use this profile as a group of custom settings, and rename the profile if desired. Once this profile is activated, the LCD display's status bar will show the  icon. If you have renamed this profile, the new name will replace Personal in the profiles list.

2. Press  to scroll to the desired profile, and then press  (**Edit**) to modify the settings listed below and adjust the profile to suit a particular environment.

Vibration

Includes the following setting options:

- **Ring Only:** When there is an incoming call, the phone will use a ring tone but no vibrating alert.
- **Vibrate Only:** When there is an incoming call, the phone will use a vibrating alert but no ring tone.
- **Ring & Vibrate:** When there is an incoming call, the phone will use both a vibrating alert and a ring tone.
- **Vibrate then Ring:** When there is an incoming call, the phone will first use a vibrating alert and then a ring tone.

Call Ring

Your phone includes various types of ring tone melodies. Scroll to the desired ring tone, and after one second or so you will be able to hear that ring tone. Press  to confirm your selection.

Message Tone

The ring tone that your phone uses when a message is received.

Calendar Tone

The ring tone used for Calendar events for which you have set an alarm.

Keypad Tone

Determines whether keypad tones are played when keys are pressed.



Ring Volume

Press  to adjust the ring tone volume or mute the ring tone.



Answer Mode

- **Send Key:** Allows incoming calls to be answered only by pressing .

- **Any Key:** Allows any key except  to be used to answer an incoming call. In this mode,  is used to reject an incoming call, and not to answer.
- **Automatic:** If the **Automatic** answer mode is activated, the phone will ring for five seconds, and then the incoming call will be automatically answered (only the **Handsfree** profile allows this setting).

Rename

Allows you to provide a new name for the profile (only available for the **Personal** profile).

Restore





Returns the above settings for the profile to their factory default values.

 Requires entry of the phone password, whose default value is 1234.

Display



Wallpaper

Designates the wallpaper used for the LCD display's standby screen.

Select image or photo and press  to enter the image or photo library. Scroll to the name of the image or photo that you wish to use, press  to view the whole image. Press  will display the next or previous image or photo; Press  to confirm your selection.

Welcome Message



Used to select and configure the image, photo, music or text that is displayed when the phone is turned on.

- **Image:** Press  (**Edit**) to enter the image library. Only the image selected in this option will be displayed when the phone is turned on. After selecting an image, you will need to select the desired music to be played when the phone is turned on. Select Silent if you do not wish any music to be played.
- **Photo:** Follow the same steps as selecting images.
- **Text:** Press  (**Edit**) to input the text. Only the text entered in this option will be displayed when the phone is turned on. After inputting text, you will need to select the desired music to be played when the phone is turned on. Select Silent if you do not wish any music to be played.
- **Off:** Returns the settings for startup music and animation to their factory default values.

Personal Banner



Enter the text you wish to be displayed on the standby screen.

Contrast

Press  to adjust the contrast of the screen's display. Press  to confirm the setting.



Brightness

Press  to adjust the brightness of the phone's display backlighting. Press  to confirm the setting.



Audio

This menu allows you to set various sounds that the phone uses.

 Some of the options provided in this menu and the **Profiles** menu are identical (for example, Call Ring). Therefore the particular setting that the phone uses will depend on which menu you last used to make the setting.

Call Settings

Answer Mode

- **Any Key:** Allows any key except  to be used to answer an incoming call. In this mode,  is used to reject an incoming call, and not to answer.
- **Send Key:** Allows incoming calls to be answered only by pressing .

Connect Alert

This feature allows the phone to provide a ring tone or vibrating alert, or flash the backlighting when the recipient of a call has answered.

Minute Minder

If you turn this function on, the phone will emit a beep per minute during a call.

Show Number

You can decide whether or not to display your phone number on the recipient's phone when you make a call.

On: When you call someone, the recipient's phone will display your phone number.

Off: Your phone number will not be shown on the recipient's phone.

 If this feature is turned off, you may not be able to make phone calls in certain countries, such as Singapore and China.



Preset: Whether your phone number will be displayed on a recipient's phone will be determined by the default set by the network operator.

Call Divert

 Requires the support of the network operator.

Forward All

Forwards all incoming calls to a designated phone number or voicemail inbox. When you use this feature, you must enter a phone number to which to forward incoming calls.

 After the **Forward All** mode is activated, the standby screen will display the  icon.

When Busy

The phone will divert incoming calls to another number when you are in the middle of another call.

No Reply

Forwards incoming calls to another number when you do not answer.

Not Reachable

Diverts incoming calls when your phone is turned off or outside network coverage.

Cancel All

Cancels all call divert options.

Call Barring

You can request that your network operator block the dialing or receiving of certain calls. The call barring services below require the support of your network operator. To activate or cancel any of the options below, you must enter the network password provided by the network operator.

All Outgoing

Blocks dialing of any calls from the phone.

Intl. Out

If this option is activated, no international calls can be made with your phone.

Intl. Except Home

If this option is activated, your phone can only be used to dial local calls and calls to your home country from abroad. Other international calls will be barred.

All Incoming

Rejects all incoming calls.

Incoming When Roaming

If you are in another country (using roaming), activating this option will cause the phone to reject all incoming calls.

Cancel All

Cancels all call barring settings. You must enter the network password in order to cancel these settings.

Change Password

You can change the network password, which can be obtained from the network operator.

Call Waiting

If there is an incoming call when you are in the middle of another call, the screen will display the number of the incoming call and call waiting message to alert you. You can activate, cancel, or view the status of this feature from this menu.



You must apply to the network operator for the call waiting service in order to use this feature.

Auto Redial

If there is no answer at a number you have dialed, the phone will automatically redial.

Fixed Dialing Number



After this feature is activated, the phone will only be able to dial numbers on the Fixed Dial Number list. If a number is not on the list, calls cannot be made to this number.



When you activate or cancel this feature, you must enter the PIN2 code.



If the PIN2 code is entered incorrectly three consecutive times, the PIN2 code will be locked down. You will need the PUK2 code to unlock the PIN2 code. Contact your network operator to obtain the PUK2 code.

Before activating the Fixed Dial Number feature, you must press  (**View**), then press  (**Option**) and select **Add** to create a Fixed Dial Number list. You must enter the PIN2 code, and then add a new number to your Fixed Dial Number list. After creating the list, you can view, edit and delete numbers in the list.

Active Line

This feature allows you to use two different phone numbers on one phone. You can designate one number for dialing calls, while accepting incoming calls dialed to both numbers without needing to use two phones. Select either **Line 1** or **Line 2**. The number you select (**1** or **2**) will appear on the standby screen.

 This feature requires the support of the network operator.

User Group

User Group

Used to create a closed group of callers based on a service provided by the network operator. The members of a User Group can call each other, but cannot conduct calls with anyone outside the group unless special provisions are made. This option can be used to select whether or not to activate this service.

Outside Access

When the User Group service is activated, enabling Outside Access will allow users in the group to make calls to numbers outside the group. However, incoming calls will still be restricted to calls from within the group.

Network

Generally speaking, the choice of the network that your phone uses is configured automatically. When turned on, the phone will automatically connect to the network provided by your network operator, or will automatically connect to the roaming network when you are outside the coverage of your regular network.

If you wish to change the connection network, this menu will allow you to select the network you want to use. When outside the coverage of

your regular network in your home country or when abroad, you can manually select the local network system.



Your network operator must be able to support network selection in order for you to use this feature.

Network Mode

You can choose whether the network selection mode that the phone will use when it is turned on is automatic or manual.

Automatic: If this option is selected, when outside the coverage of your regular network, the phone will automatically search for usable networks.

Manual: If this option is selected, when outside the coverage of your regular network, the phone will list all the networks of telecom vendors and allow you to choose.

Available List

Allows you to manually select a network. Your phone will list all the networks of telecoms vendors so you can choose.



Not all networks listed will necessarily be available for use. If you require further information, contact your network operator.

Band Setting

According to your requirements, you can set an appropriate band in the GSM network system.

Connection

Used to set whether the phone will also search for a GPRS network when it is turned on.

- **GPRS & GSM:** When it is turned on, the phone will search for available GPRS and GSM networks.
- **GSM Only:** When it is turned on, the phone will search only for a GSM network.

Service Tone

Used to set whether the phone will sound when it detects an available network.

Security

You can use a PIN code, phone password, and SIM card lock authentication to prevent unauthorized use of the phone.

PIN Code

A PIN (Personal Identification Number) code is a password provided by a network operator. When PIN code authentication is activated, it will prevent unauthorized use of the SIM card. Unless the correct PIN code is entered when the phone is turned on, the SIM card cannot be used, even if it is inserted in another phone.



If the PIN code is entered incorrectly three consecutive times, this will cause the SIM card to lock down, and a PUK1 code provided by the network operator will be required to unlock it. After unlocking, the PIN code will be automatically set to activate once the phone is turned on.

PIN Code

Used to activate/deactivate or change the PIN Code. Before changing settings for the PIN Code feature, the previously set PIN Code must be entered.

If you wish to change the PIN Code, you must press  in the **Enable** item to select **On**, so that you will be able to enter and confirm the new password.

PIN2 Code

Used to change the PIN2 code. The procedure is the same as for the PIN Code.

Phone Lock

Activates/deactivates or changes the phone's startup password. The startup password prevents unauthorized persons from using your phone. Once the phone's password is activated, the phone will be locked down when it is turned on unless this password is correctly entered. If an incorrect password is entered, your phone will remain locked down, and cannot be unlocked even if the SIM card is replaced by another one. When the phone is locked, you will only be able to make emergency calls.

Once the phone password is activated, you must enter the password each time the phone is turned on in order to unlock the phone (there is no limit on the number of attempts to enter the phone password).

The procedure for setting the phone password is the same as for the PIN Code (the default phone password is 1234).

SIM Lock

Using this feature, you can prevent unauthorized persons from using your phone with other SIM cards. After you activate the SIM Lock feature, only the SIM card present when the feature was activated will be accepted by the phone. If a new SIM card is inserted in the phone, when the phone is turned on and a PIN code is entered, the phone will request entry of a SIM Lock password (there is no limit on the number of attempts to enter the SIM Lock password).

If the password is entered correctly, the phone will be able to recognize the new SIM card and use it normally. The next time the phone is turned on with this SIM card inserted, the phone will not ask again for you to enter the SIM Lock password.

 Your phone can recognize a maximum of three different SIM cards.

Before setting the SIM Lock feature, you must enter the previously set SIM Lock password (the default SIM Lock password is 1234). The password must be between 4 and 8 digits in length.

Screen Lock

Used to create a security screensaver. When you have not performed any tasks with the phone for a set period of time, the phone will automatically activate the screensaver shown on the right. To activate the screen lock, you must first enter the Screen Lock password that was previously set (the



default password is 1234). Scroll to **On** and press  (**Edit**) to set a different period of inactivity for the screen lock to be activated.

Keypad Lock

Used to create a keypad lock. When you have not performed any tasks with the keypad for a set period of time, the keypad will be locked. Scroll to **Auto Lock** and press  (**Edit**) to set a different period of inactivity for the keypad lock to be activated automatically.

Power Saving Mode

After you activate the power saving mode, keypad and display backlighting will be turned off, in order to conserve power.

Language

You can select the language that the phone will use to display information.

Input

You can set the default input mode that will be automatically activated whenever you open the editing window for entering information into a message, the Phone Book, and so forth.

Restore

Restores all of the phone's settings to their factory defaults.

5 Care and Maintenance

Take note of the points noted below to ensure that you are using the phone properly and to extend the lifespan of the phone.

- Store the phone and its accessories out of the reach of children.
- Keep the phone and accessories dry, and use the phone in environments where the temperature is between -20°C and 55°C . High or low temperatures outside this range may damage the phone.
- If possible, do not use or store the phone in excessively dusty or dirty environments.
- Do not remove the warranty seal on the phone yourself, nor allow an unauthorized dealer to do so.
- Do not use strong detergents or organic solvents to wipe or clean the phone.
- If your phone or its accessories are not operating normally, contact an authorized dealer immediately.
- Use only genuine BenQ accessories such as batteries, battery charger and hands-free kit to ensure the phone's normal operation and preserve battery life, as well as protect the safety of your person and belongings. Use of non-BenQ accessories will not allow your phone to achieve optimal performance, and may cause the phone to malfunction. Any malfunctions or damage caused by the use of third-party accessories are not covered by the terms of the product warranty, and will void the product warranty.
- Avoid allowing objects that may discharge electricity to contact the charging socket on the bottom of the phone or the metal contacts on the battery, as this may cause short circuits and put you in danger.

Troubleshooting

If you encounter problems while using the phone, or if it performs erratically, you can consult the information in the chart below. If your particular problem cannot be resolved using the information in the chart, contact the dealer where you purchased the phone.

Problem	Possible cause	Solution
Poor reception	<ul style="list-style-type: none">• The network signal is too weak at your current location — for example, in a basement or near a tall building—because wireless transmissions can not effectively reach it.	Move to a location where the network signal can be properly received.
	<ul style="list-style-type: none">• The network is busy at the current time (for example, during peak times, there may be too much network traffic to handle additional calls).	Avoid using the phone at such times, or try again after waiting a short time.
	<ul style="list-style-type: none">• You are too far away from a base station for your network operator.	You can request a service area map from your network operator.
Echo or noise	<ul style="list-style-type: none">• Poor network trunk quality on the part of your network operator.	Hang up the phone and dial again. You may be switched to a better-quality network trunk or phone line.
	<ul style="list-style-type: none">• Poor local telephone line quality.	

Problem	Possible cause	Solution
Shortened standby time	<ul style="list-style-type: none"> The standby time is related to your network operator's system configuration. The same phone used with different network operators' systems will not provide exactly the same length of standby time. 	If you are located in an area where signaling is weak, temporarily shut off the phone.
	<ul style="list-style-type: none"> The battery is depleted. In high-temperature environments, battery life will be shortened. 	Use a new battery.
	<ul style="list-style-type: none"> If you are not able to connect to the network, the phone will continue to send out signals as it attempts to locate a base station. Doing so consumes battery power and will consequently shorten standby time. 	Change your location to one where the network is accessible, or temporarily turn off your phone.
You cannot switch your phone on.	<ul style="list-style-type: none"> Battery power has been depleted. 	Recharge the phone's battery.
SIM card error	<ul style="list-style-type: none"> SIM card malfunction or damage. 	Take the SIM card to your network operator for testing.
	<ul style="list-style-type: none"> SIM card inserted improperly. 	Insert the SIM card properly.
	<ul style="list-style-type: none"> Debris on the SIM card contacts. 	Use a soft, dry cloth to clean the SIM card contacts.

Problem	Possible cause	Solution
Unable to connect to the network.	• SIM card invalid.	Contact your network operator.
	• You are not within the network's service area.	Check the service area with your network operator.
	• Poor signal.	Move to an open space, or if you are inside a building, move closer to a window.
You cannot answer incoming calls.	• You have activated the Call Barring feature.	Go to the menu Settings → Call Settings → Call Barring , and then select Cancel All .
You cannot make outgoing calls.	• You have activated the Call Barring feature.	Go to the menu Settings → Call Settings → Call Barring , and then select Cancel All .
	• You have activated the Fixed Dial Number feature.	Go to the menu Settings → Call Settings → Fixed Dial Number , and then select Off to turn off this feature.
PIN Code is blocked.	• You have entered an incorrect PIN code three consecutive times.	Contact your network operator. If the network operator provides the SIM card's PUK code, use the PUK code to unlock the SIM card.
Battery will not charge.	• The battery or battery charger is damaged.	Contact the dealer.
	• The phone's temperature is below 0° C or higher than 45° C.	Adjust the battery charging environment to avoid extremes of temperature.
	• Poor contact between the battery and charger.	Check all connectors to make sure all connections have been properly made.

Problem	Possible cause	Solution
Unable to enter information into the Phone Book.	<ul style="list-style-type: none"><li data-bbox="285 145 593 196">• The Phone Book's memory is already full.	Delete unnecessary data from the Phone Book.
Unable to select certain features.	<ul style="list-style-type: none"><li data-bbox="285 296 593 419">• Your network operator does not support these features, or you have not applied for services that provide these features.	Contact your network operator.