



**Canon**

Canon DIGITAL CAMERA PowerShot A520/A510 Camera User Guide

**Canon**  
**PowerShot A520**  
**PowerShot A510**  
 DIGITAL CAMERA  
**Camera User Guide**



- Please read the *Read This First* section (p. 4).
- Please also see the *Software Starter Guide* and the *Direct Print User Guide*.

## Disclaimer

- While every effort has been made to ensure that the information contained in this guide is accurate and complete, no liability can be accepted for any errors or omissions.
- Canon reserves the right to change the specifications of the hardware and software described herein at any time without prior notice.
- No part of this guide may be reproduced, transmitted, transcribed, stored in a retrieval system, or translated into any language in any form, by any means, without the prior written permission of Canon.
- Canon makes no warranties for damages resulting from corrupted or lost data due to a mistaken operation or malfunction of the camera, the software, memory cards, personal computers, peripheral devices, or use of non-Canon memory cards.

## Trademark Acknowledgements

- Macintosh, Mac OS and QuickTime are trademarks of Apple Computer Inc., registered in the United States and/or other countries.
- Microsoft® and Windows® are either registered trademarks or trademarks of Microsoft Corporation in the United States and/or other countries.
- SD is a trademark.
- Other names and products not mentioned above may be registered trademarks or trademarks of their respective companies.



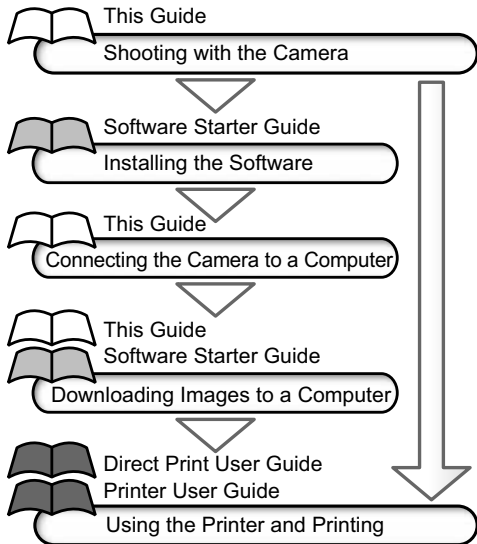

### **Use of genuine Canon accessories is recommended.**

This product is designed to achieve excellent performance when used with genuine Canon accessories. Canon shall not be liable for any damage to this product and/or accidents such as fire, etc., caused by the malfunction of non-genuine Canon accessories (e.g., a leakage and/or explosion of a battery pack). Please note that this warranty does not apply to repairs arising out of the malfunction of non-genuine Canon accessories, although you may request such repairs on a chargeable basis.

## Flowchart and Reference Guides



## Symbols Used

Icons under title bars show the available shooting modes. As in the example below, the shooting mode dial should be set to **AUTO**, **P**, **Tv**, **Av**, **M**, , , , , **CF**, **SCN** or .

### ⚡ Using the Flash

Mode Dial **AUTO P Tv Av M**     **CF** **SCN** 



This mark denotes issues that may affect the camera's operation.







This mark denotes additional topics that complement the basic operating procedures.









**This camera can use SD\* memory cards or MultiMediaCards.**

\* SD=Secure Digital, a copyright protection system.

# Table of Contents

Items marked with ★ are lists or charts that summarize camera functions or procedures.

<b>Read This First</b>	<b>4</b>
Please Read .....	4
Safety Precautions .....	6
Preventing Malfunctions .....	11
<b>Components Guide</b>	<b>12</b>
<b>Preparing the Camera</b>	<b>15</b>
Installing the Batteries .....	15
Installing the Memory Card .....	18
Formatting Memory Cards .....	19
Setting the Date/Time .....	22
Setting the Language .....	23
★ Using the LCD Monitor .....	24
<b>Basic Functions</b>	<b>30</b>
Turning the Power On/Off .....	30
Switching between Shooting and Playback.....	32
<b>Shooting – The Basics</b>	<b>33</b>
 Auto Mode .....	33
Reviewing an Image Right after Shooting .....	36
Using the Mode Dial (Image Zone) .....	38
 Portrait .....	38
 Landscape .....	38
 Night Scene .....	38
 Fast Shutter .....	38

 Slow Shutter .....	38
Changing the Resolution and Compression....	40
 Using the Flash .....	42
 Macro Mode .....	44
Self-timer.....	45
Digital Zoom .....	47
Continuous Shooting.....	48
 Shooting Panoramic Images (Stitch Assist)...	49
scn Special Scene Mode .....	51
Postcard Print Mode.....	54
 Movie Mode .....	56
<b>Playback – The Basics</b>	<b>58</b>
Displaying Images Individually (Single Image Playback)..	58
 Magnifying Images.....	59
 Viewing Images in Sets of Nine (Index Playback)..	60
Jumping between Images .....	61
Viewing/Editing Movies .....	61
<b>Erasing</b>	<b>65</b>
 Erasing Images Individually .....	65
Erasing All Images .....	65
<b>Shooting – Advanced Functions</b>	<b>66</b>
★ Selecting Menus and Settings.....	66
★ Menu Settings and Default Settings.....	69
Resetting the Settings to Default.....	75
Using the Mode Dial (Creative Zone).....	76
<b>P</b> Program AE .....	77

<b>Tv</b> Setting the Shutter Speed .....	77
<b>Av</b> Setting the Aperture .....	79
<b>M</b> Manually Setting the Shutter Speed and Aperture ..	80
Switching between Focusing Modes .....	81
Switching between Metering Modes .....	82
Adjusting the Exposure .....	83
Adjusting the Tone (White Balance) .....	84
Changing the ISO Speed .....	87
Changing the Photo Effect .....	88
Adjusting the Flash Output .....	89
Shooting Hard-to-Focus Subjects .....	90
Setting the Auto Rotate Function .....	92
<b>Playback – Advanced Functions</b> .....	<b>94</b>
Rotating Images in the Display .....	94
Attaching Sound Memos to Image .....	95
Auto Play .....	96
Protecting Images .....	97
<b>Various Functions</b> .....	<b>98</b>
About Printing .....	98
DPOF Print Settings .....	100
Image Transmission Settings (DPOF Transfer Order) ...	104
Downloading Images to a Computer .....	106
Computer System Requirements .....	107
Viewing Images on a TV Set .....	114
Resetting the File Number .....	115
Customizing the Camera (My Camera Settings) ..	117
Registering My Camera Settings .....	118

<b>List of Messages</b> .....	<b>121</b>
<b>Troubleshooting</b> .....	<b>123</b>
<b>Appendix</b> .....	<b>129</b>
Using the Power Kits (Sold Separately) .....	129
Using the Lenses (Sold Separately) .....	132
Using an Externally Mounted Flash (Sold Separately) ..	136
Replacing the Date Battery .....	137
Camera Care and Maintenance .....	139
<b>Specifications</b> .....	<b>140</b>
Battery Performance .....	144
Memory Cards and Estimated Capacities (Recordable Images) .....	145
<b>Photo Tips and Information</b> .....	<b>151</b>
<b>INDEX</b> .....	<b>153</b>
★ Functions Available in Each Shooting Mode ..	159

## Please Read

---

### Test Shots

Before you try to photograph important subjects, we highly recommend that you shoot several trial images to confirm that the camera is operating and being operated correctly. Please note that Canon Inc., its subsidiaries and affiliates, and its distributors are not liable for any consequential damages arising from any malfunction of a camera or accessory, including memory cards, that results in the failure of an image to be recorded or to be recorded in a way that is machine readable.

### Warning Against Copyright Infringement

Please note that Canon digital cameras are intended for personal use and should never be used in a manner that infringes upon or contravenes international or domestic copyright laws and regulations. Please be advised that in certain cases the copying of images from performances, exhibitions, or commercial properties by means of a camera or other device may contravene copyright or other legal rights even if the image was shot for personal use.

### Warranty Limitations

This camera's warranty is only effective in the country of sale. If a problem arises while the camera is in use abroad, please convey it back to the country of sale before proceeding with a warranty claim to a Canon Customer Support Help Desk.

**For Canon Customer Support contacts, please see the *Canon Limited Warranty* supplied with your camera.**

**Camera Body Temperature**

If your camera is used for prolonged periods, the camera body may become warm. Please be aware of this and take care when operating the camera for an extended period.

**About the LCD Monitor**

The LCD monitor is produced with extremely high-precision manufacturing techniques. More than 99.99% of the pixels operate to specification. Less than 0.01% of the pixels may occasionally misfire or appear as red or black dots.

This has no effect on the recorded image and does not constitute a malfunction.

**Video Format**

Please set the camera's video signal format to the one used in your region before using it with a TV monitor (p. 115).

**Language Setting**

Please see page 23 to change the language setting.

## Safety Precautions

- Before using the camera, please ensure that you read and understand the safety precautions described below. Always ensure that the camera is operated correctly.
- The safety precautions noted on the following pages are intended to instruct you in the safe and correct operation of the camera and its accessories to prevent injuries or damage to yourself, other persons and equipment.
- In the next few pages, the term “equipment” refers primarily to the camera and its power supply accessories (see the *System Map* for power supply accessory details).



### Storing memory cards

**Store the memory card out of the reach of children and infants.**

It may be swallowed accidentally. If this occurs, consult a doctor immediately.



## WARNINGS

- **Do not aim the camera directly into the sun or at other intense light sources that could damage your eyesight.**
- **Do not trigger the flash in close proximity to human or animal eyes.** Exposure to the intense light produced by the flash may damage eyesight. In particular, remain at least one meter (39 inches) away from infants when using the flash.
- **Store this equipment out of the reach of children and infants.** Accidental damage to the camera or batteries by a child could result in serious injury. In addition, placement of the strap around a child's neck could result in asphyxiation.
- **Be particularly careful to keep the date battery used in the camera away from children.** Seek medical assistance immediately if a child swallows a battery.



- 
- **Do not attempt to disassemble or alter any part of the equipment that is not expressly described in this guide.** Disassembly or alteration may result in high-voltage electrical shock. Internal inspections, alterations and repairs should be conducted by qualified service personnel authorized by your camera distributor or a Canon Customer Support Help Desk.

---

  - **To avoid the risk of high-voltage electrical shock, do not touch the flash portion of the camera if it has been damaged.** Similarly, never touch internal portions of the equipment that become exposed as a result of damage. There is a risk of high-voltage electrical shock. Please take the first opportunity to consult your camera distributor or a Canon Customer Support Help Desk.

---

  - **Stop operating the equipment immediately if it emits smoke or noxious fumes.** Failure to do so may result in fire or electrical shock. Immediately turn the camera's power off, remove the camera batteries or unplug the power cord from the power outlet. Confirm that smoke or fume emissions have ceased. Please consult your camera distributor or the closest Canon Customer Support Help Desk.

---

  - **Stop operating the equipment if it is dropped or the casing is damaged.** Failure to do so may result in fire or electrical shock. Immediately turn the camera's power off, remove the camera batteries or unplug the power cord from the power outlet. Please consult your camera distributor or the closest Canon Customer Support Help Desk.

---

  - **Do not allow the equipment to come into contact with, or become immersed in, water or other liquids.** Do not allow liquids to enter the interior. The equipment has not been waterproofed. If the exterior comes into contact with liquids or salt air, wipe it dry with a soft, absorbent cloth. In the event that water or other foreign substances enter the interior, immediately turn the camera's power off and remove the camera batteries or unplug the power cord from the power outlet. Continued use of the equipment may result in fire or electrical shock. Please consult your camera distributor or the closest Canon Customer Support Help Desk.

---

  - **Do not use substances containing alcohol, benzene, thinners or other flammable substances to clean or maintain the equipment.** The use of these substances may lead to fire.
-

- **Remove the power cord on a regular periodic basis and wipe away the dust and dirt that collects on the plug, the exterior of the power outlet and the surrounding area.** In dusty, humid or greasy environments, the dust that collects around the plug over long periods of time may become saturated with humidity and short-circuit, leading to fire.
- **Do not cut, damage, alter or place heavy items on the power cord.** Any of these actions may cause an electrical short circuit, which may lead to fire or electrical shock.
- **Do not handle the power cord if your hands are wet.** Handling it with wet hands may lead to electrical shock. When unplugging the cord, ensure that you hold the solid portion of the plug. Pulling on the flexible portion of the cord may damage or expose the wire and insulation, creating the potential for fires or electrical shocks.
- **Use only the recommended power accessories.** Use of power sources not expressly recommended for this equipment may lead to overheating, distortion of the equipment, fire, electrical shock or other hazards.
- **Do not place the batteries near a heat source or expose them to direct flame or heat.** Neither should you immerse them in water. Such exposure may damage the batteries and lead to the leakage of corrosive liquids, fire, electrical shock, explosion or serious injury.
- **Do not attempt to disassemble, alter or apply heat to the batteries.** There is serious risk of injury due to an explosion. Immediately flush with water any area of the body, including the eyes and mouth, skin, or clothing that comes into contact with the inner contents of a battery. If the eyes or mouth contact these substances, immediately flush with water and seek medical assistance.
- **Avoid dropping or subjecting the batteries to severe impacts that could damage the casings.** It could lead to leakage and injury.
- **Do not short-circuit the battery terminals with metallic objects, such as key holders.** It could lead to overheating, burns and other injuries.

- **Before you discard a battery, cover the terminals with tape or other insulators to prevent direct contact with other objects.** Contact with the metallic components of other materials in waste containers may lead to fire or explosions. Discard the batteries in specialized waste facilities if available in your area.
- **Use only recommended batteries and accessories.** Use of batteries not expressly recommended for this equipment may cause explosions or leaks, resulting in fire, injury and damage to the surroundings.
- **If using AA-size NiMH batteries, use only Canon AA-size NiMH batteries and the charger recommended for use with these batteries.** Use of another charger may cause batteries to overheat or deform, posing risk of fire or electric shock.
- **Disconnect the battery charger or compact power adapter from both the camera and power outlet after recharging and when the camera is not in use to avoid fires and other hazards.** Continuous use over a long period may cause a unit to overheat and distort, resulting in fire.
- **The camera terminal of the compact power adapter is designed for exclusive use with your camera.** Do not use it with other products or batteries. There is a risk of fire and other hazards.
- **Exercise due caution when screwing on the separately sold wide converter, tele-converter, close-up lens and conversion lens adapter.** If they loosen, fall off and shatter, the glass shards may cause an injury.

#### **Caution about magnetic fields**

Keep objects that are sensitive to magnetic fields (such as credit cards) away from the speaker of the camera (p. 12). Such items may lose data or stop working.

## CAUTIONS

- **Avoid using, placing or storing the equipment in places subject to strong sunlight or high temperatures, such as the dashboard or trunk (boot) of a car.** Exposure to intense sunlight and heat may cause the batteries to leak, overheat or explode, resulting in fire, burns or other injuries. High temperatures may also cause deformation of the casing. Ensure that there is good ventilation when using the battery charger to charge the batteries.
- **Do not store the equipment in humid or dusty areas.** Storage in such areas could lead to fire, electrical shock or other damage.
- **Be careful not to bang the camera or subject it to strong impacts or shocks that could lead to injury or damage the equipment when wearing or holding it by the strap.**
- **Be careful not to cover the flash with your fingers or clothing when shooting.** The flash may be damaged and emit smoke or noise. In addition, do not touch the surface of the flash after taking several pictures in rapid succession. Either action could result in burns.
- **Do not operate the flash with dirt, dust or other items stuck to its lens.** The resulting heat build-up could damage the flash.
- **Ensure that the battery charger or compact power adapter is plugged into a power outlet of the specified rating, not over the specified rating.** The plug of the battery charger varies according to region.
- **Do not use the battery charger or compact power adapter if the cable or plug is damaged, or if the plug is not fully inserted into the power outlet.**
- **Do not allow metal objects (such as pins or keys) or dirt to contact the charger terminals or plug.**
- **If your camera is used for prolonged periods, the camera body may become warm.** Please take care when operating the camera for an extended period as your hands may experience a burning sensation.

## Preventing Malfunctions

---

### **Avoid Strong Magnetic Fields**

Never place the camera in close proximity to electric motors or other equipment generating strong electromagnetic fields. Exposure to strong magnetic fields may cause malfunctions or corrupt image data.

### **Avoid Condensation Related Problems**

Moving the equipment rapidly between hot and cold temperatures may cause condensation (water droplets) to form on its external and internal surfaces. You can avoid this by placing the equipment in an airtight, resealable plastic bag and letting it adjust to temperature changes slowly before removing it from the bag.

### **If Condensation Forms Inside the Camera**

Stop using the camera immediately if you detect condensation.

Continued use may damage the equipment. Remove the memory card, batteries, and compact power adapter from the camera and store it at room temperature until the moisture evaporates completely before resuming use.

### **Extended Storage**

When not using the camera for extended periods of time, remove the batteries from the camera or battery charger and store the equipment in a safe place. Storing the camera for extended periods with batteries installed may cause battery leakage and damage the camera. (Do not remove the date battery.)

# Components Guide

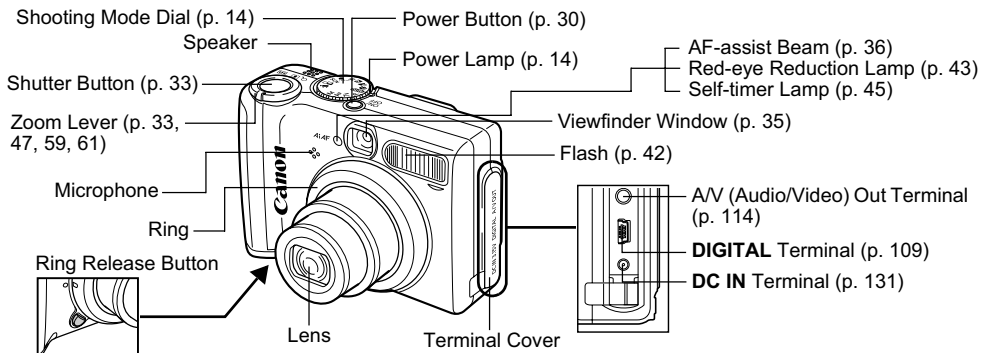

The following cables are used to connect the camera to a computer or printer.

## **Computer (p. 106)**

Interface Cable IFC-400PCU (supplied with the camera)

## **Direct Print Compatible Printers (sold separately)**

- Compact Photo Printers (SELPHY CP series), Card Photo Printers: Interface Cable IFC-400PCU (supplied with the camera), or the Direct Interface Cable DIF-100 (supplied with the printer).
- Bubble Jet Printers (PIXMA series/SELPHY DS series)
  - *Bubble Jet Direct* Compatible Printers: Please refer to your Bubble Jet printer user guide.
  - *PictBridge* Compliant Printers: Interface Cable IFC-400PCU (supplied with the camera).
- *PictBridge* Compliant Non-Canon Printers: Interface Cable IFC-400PCU (supplied with the camera).

**Please refer to the *System Map* or the *Direct Print User Guide* supplied with the camera for direct print compatible printer information.**

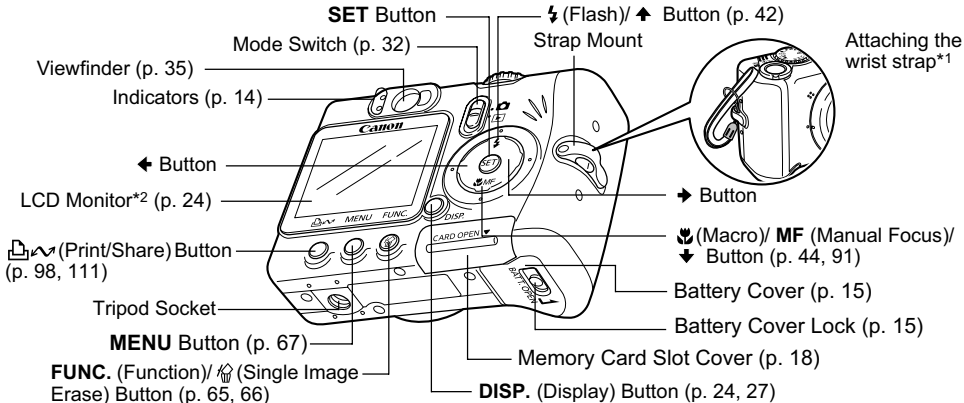

**The following operations are accessible through one easy press of the 📷 (Print/Share) button.**

- Printing: See the *Direct Print User Guide* (separate from this guide)
- Downloading images (Windows only): See page 106 of this guide and the *Software Starter Guide* (separate from this guide)

The indicator blinks or lights during a printer or computer connection.

Blue: Ready to print/Ready to transfer images

Blinking Blue: Printing/Transferring (p. 111)

\*1 When carrying the camera by the strap, be careful not to swing the camera or catch it on other items.

\*2 The LCD monitor is covered with a thin plastic sheet for protection against scratches during shipment. Remove it before using the camera.

## Shooting Mode Dial

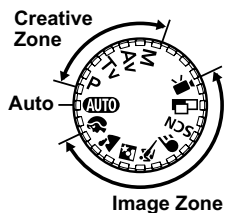

Use the shooting mode dial to switch between the Shooting modes.

● **AUTO:** Auto (p. 33)

The camera automatically selects settings.

### ● Image Zone

The camera automatically selects settings according to the image composition type.

- 👤 : Portrait (p. 38) 🏞️ : Landscape (p. 38)
- 🌃 : Night Scene (p. 38) 📷 : Fast Shutter (p. 38)
- 📸 : Slow Shutter (p. 38)
- SCN : Special Scene (p. 38, 51)
- 📐 : Stitch Assist (p. 38, 49) 🎥 : Movie (p. 56)

### ● Creative Zone

The user selects exposure, aperture or other settings to achieve special effects.

- P** : Program AE (p. 77)
- Tv** : Shutter-speed priority AE (p. 77)
- Av** : Aperture-priority AE (p. 79)
- M** : Manual Exposure (p. 80)

## Indicators

The indicators light or blink when the Power button or the shutter button is pressed.

### Upper Indicator

**Green:** Ready to shoot

**Blinking Green:** Recording to memory card/  
Reading memory card/Erasing from memory card/  
Transmitting data (during a computer connection)

**Orange:** Ready to shoot (flash on)

**Blinking Orange:** Ready to shoot (camera shake warning)/Flash is charging

### Lower Indicator

**Yellow:** Macro mode/Manual Focus mode/AF Lock

**Blinking Yellow:** Focusing difficulty (although you can press the shutter button, you are recommended to shoot using the focus lock (p. 90))

### Power Lamp

**Green:** Power is on



## Installing the Batteries

Insert two AA-size alkaline batteries (supplied with the camera) or separately sold nickel metal hydride (NiMH) batteries.

**1** Be sure that the camera power is off.

**2** Slide the battery cover lock in the direction of the arrow, and open the cover.

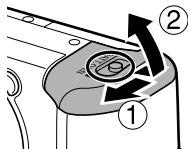

**3** Insert the batteries as shown.

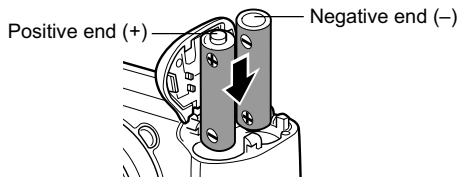

**4** Close the battery cover.



When the upper indicator blinks green, do not turn off the power or open the battery cover. The camera is writing, reading, erasing or transmitting an image to or from the memory card.



- The use of the separately sold AC Adapter Kit ACK800 is recommended to power the camera during long usage sessions (p. 131).
- The separately sold battery charger kit lets you use rechargeable NiMH batteries to power the camera (p. 129).
- See *Battery Performance* (p. 144).
- For information about the Battery and Charger Kit and AA-size rechargeable NiMH batteries, see the *System Map* (separate from this guide).

## Proper Battery Handling

- Use AA-size alkaline or Canon AA-size NiMH batteries (sold separately) only. For information on handling the AA-size rechargeable NiMH batteries, see *Using Rechargeable Batteries* (p. 129).
  - **Since the performance of alkaline batteries may differ according to brand, the operating time of the batteries you purchase may not be as long as the batteries that came with the camera.**
  - Camera operating time may shorten at low temperatures when alkaline batteries are used. Also due to their specifications, alkaline batteries may expire faster than NiMH batteries. If you are using the camera in cold areas or for a long time, we recommend using Canon AA-size NiMH Battery Kit (a four-piece set).
  - While it is possible to use AA-size nickel-cadmium batteries, performance is unreliable and their use is not recommended.
  - **Never mix unused and partially used batteries. Always load two fresh (or fully recharged) batteries at the same time. The partially used batteries may leak.**
- **Be careful to load the batteries with their positive (+) and negative (–) ends in the right direction.**
  - **Never mix batteries of different types or from different manufacturers. Both batteries should be identical.**
  - Before inserting the batteries, wipe the battery terminals well with a dry cloth. Oil from one's skin or other dirt may cause a considerable reduction in the number of recordable images or reduced usage time.
  - Battery performance deteriorates at low temperatures (especially with alkaline batteries). If you are using the camera in cold areas and batteries are running down faster than they should, you may be able to restore performance by placing batteries in an inner pocket to warm them up prior to use. But be careful that you don't put the batteries into a pocket together with a metal key chain or other metallic objects, as these objects may cause batteries to short-circuit.
  - If you do not plan to use the camera for a long time, remove the batteries from the camera and store them in a safe place. Batteries may leak and damage the camera if left installed during prolonged periods of non-use.

**⚠ WARNING**

Never use damaged batteries or batteries whose outer seal is completely or partially missing or peeled off, as there is risk that such batteries may leak, overheat, or burst. Always check the seals on store-bought batteries before loading them, as some batteries may come with defective seals. Do not use batteries with defective seals.

**Never use batteries that look like this.**

Batteries with all or part of the seal (electrical insulation sheath) peeled off.





The positive electrode (plus terminal) is flat.



The negative terminal is correctly formed (protruding from the metal base), but the seal does not extend up over the edge of the metal base.

**Battery Status Indications**

The LCD monitor displays an icon or message to let you know when batteries are low or depleted.

	<p>Batteries are beginning to run low. Replace or recharge the batteries if you wish to continue using the camera. If the LCD monitor is off, this icon will appear when you press any of the following buttons: <b>DISP.</b>,  or  / <b>MF</b> button.</p>
<p><b>Change the batteries</b></p>	<p>Batteries are fully depleted and the camera can no longer operate. You should replace the batteries immediately.</p>

## Installing the Memory Card

**1** Be sure that the camera is turned off.

**2** Slide the memory card slot cover in the direction of the arrow, and open it.

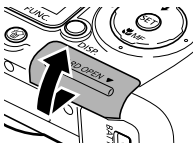

**3** Insert the memory card.

- Push the memory card in until it clicks into place.
- Do not touch or allow metal objects to contact the terminals on the back of the memory card.

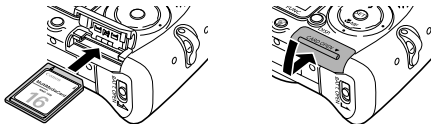

**To remove the memory card**

Push the memory card until it clicks and then release it.

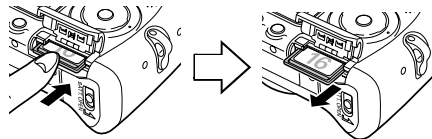

**4** Close the memory card slot cover securely.



- When the upper indicator blinks green, the camera is writing, reading, erasing or transmitting an image to or from the memory card. Do not perform the following or image data may be lost or corrupted:
  - Subject the camera body to vibration or shocks.
  - Turn the camera's power off, or open the memory card slot cover.
- Please note that memory cards formatted with other manufacturers' cameras or a computer, or formatted or edited with application programs, may slow down writing to the memory card or may not operate correctly in the camera.
- You are recommended to use memory cards that have been formatted in your camera (See *Formatting Memory Cards* (p. 19)). The card supplied with the camera may be used without further formatting.



See *Memory Cards and Estimated Capacities (Recordable Images)* (p. 145).

## Formatting Memory Cards

You should always format a new memory card or one from which you wish to erase all images and other data.



Please note that formatting (initializing) a memory card erases all data, including protected images and other data types. Please check the contents of the memory card before formatting it.

- 1 Turn the power on (p. 30).**
- 2 Press the MENU button and select the [MENU] (Set up) menu using the → button.**



**3** Select  (Format) using the **↑** or **↓** button and press the **SET** button.

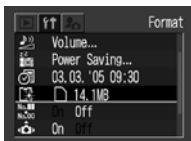

**4** Select [OK] using the **←** or **→** button and press the **SET** button.



- To cancel formatting instead, select [Cancel] and press the **SET** button.
- The capacity of the memory card displayed on the LCD monitor when formatting is less than the rated capacity of the memory card. This is not a malfunction of the memory card or camera.

**5** Press the **MENU** button.



- If the camera does not work properly, the inserted memory card may be malfunctioning. Reformatting the memory card may solve the problem.
- When a non-Canon brand memory card is malfunctioning, reformatting it may solve the problem.
- Memory cards formatted in another camera, computer or peripheral device may not operate correctly. When that happens, reformat the memory card with this camera. If formatting in the camera does not work properly, turn the camera off and reinsert the memory card. Then turn the camera back on and format again.

## Memory Card Handling Precautions

- Memory cards are high-precision electronic devices. Do not bend them, apply force to them, or subject them to shocks or vibration.
- Do not attempt to disassemble or alter the memory card.
- Do not allow dirt, water or foreign objects to contact the terminals on the back of the card. Do not touch the terminals with your hands or metal objects.
- Do not peel away the original label on the memory card or cover it with another label or sticker.
- When writing on the memory card, use a soft point pen (e.g. felt-tip pen). Using a sharp point pen (e.g. ball-point pen) or pencil may damage the memory card or corrupt the recorded data.
- Since some or all of the data recorded on the memory card may be corrupted or erased by electrical noise, static electricity or card malfunction, making a backup copy of important data is recommended.
- Moving a memory card rapidly between temperature extremes will cause condensation to form in the card and lead to a malfunction. To avoid condensation, place the memory card in a sealed plastic bag before moving it into a different temperature zone and allow it to adjust slowly to the new temperature.
- If condensation forms on the memory card, store it at room temperature until the water droplets have evaporated naturally.
- Do not use or store memory cards in the following locations.
  - Locations subject to dust or sand
  - Locations subject to high humidity and high temperatures

## Setting the Date/Time

The Set Date/Time menu will appear the first time the camera power is turned on, or whenever the lithium date battery charge is low. Start from Step 4 to set the date and time.

**1** Turn the power on (p. 30).

**2** Press the MENU button and select the [SET] (Set up) menu using the → button.



**3** Press the ↑ or ↓ button to select [Date/Time], and then press the SET button.



**4** Set the date and time.

- Press the ← or → button to select the item you wish to set.
- Press the ↑ or ↓ button to change its value.
- The date can be set up to the year 2030.

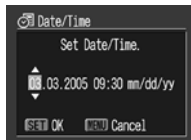

**5** Press the SET button.

**6** Press the MENU button.



- For embedding the date on the image data, refer to page 55.
- To set the camera so that the date and time will not appear on the image when it is being shot but only when it is printed, see *Setting the Print Style* (p. 103), the *Direct Print User Guide* or the *Software Starter Guide* supplied with the camera.



Replacing the Date Battery (p. 137)



## Setting the Language

Use this feature to select the language for the LCD monitor display.

**1** Turn the power on (p. 30).

**2** Press the **MENU** button and select the **[SET UP]** menu using the **→** button.



**3** Select **[LANGUAGE]** using the **↑** or **↓** button and press the **SET** button.



**4** Select a language using the **↑**, **↓**, **←** or **→** button and press the **SET** button.

English	Norsk	Polski
Deutsch	Svenska	Čeština
Français	Español	Magyar
Nederlands	简体中文	Türkçe
Dansk	Русский	繁體中文
Suomi	Português	한국어
Italiano	Ελληνικά	日本語

- The Set up menu will reappear without changing the language setting if you press the **MENU** button instead of the **SET** button.

**5** Press the **MENU** button.



### Shortcut Operation

The Language menu can also be displayed in Playback mode by holding down the **SET** button and pressing the **MENU** button. (This function cannot be used while an image is magnified or a movie clip is played back, or when a printer is connected to the camera.)

## Using the LCD Monitor

The LCD monitor can be used to compose images while shooting, adjust menu settings and play back recorded images. Pressing the **DISP.** button switches the LCD monitor display mode.

### Shooting Mode

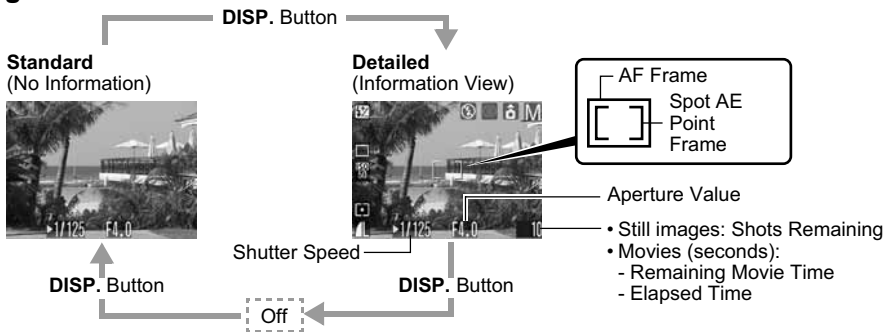

When the shutter button is pressed halfway, the AF frame will display as follows (when the LCD monitor is on).

#### AiAF set to [On] (p. 81)

- Green: Focusing complete (focused AF frame)
- Does not appear: Focusing difficulty

#### AiAF set to [Off] (p. 81) (1-point AF)

- Green: Focusing complete
- Yellow: Focusing difficulty

## Icons Displayed in Shooting Mode



	Shooting Mode	p. 38, 76
-2...+2	Exposure Compensation	p. 83
	White Balance	p. 84
	Drive Mode	p. 45, 48
	ISO Speed	p. 87
	Photo Effect	p. 88
	Metering Mode	p. 82
	Compression	p. 40
	Resolution Postcard Print	p. 40, 54
	Flash	p. 42
	Red-eye Reduction	p. 43
	Macro Mode	p. 44
	Manual Focus	p. 91
	Auto Rotate Function	p. 92
● (Red)	Movie Recording Mode	p. 56

	PowerShot A520: 5.7x 7.1x 8.9x 11x 14x PowerShot A510: 5.1x 6.4x 8.0x 9.8x 13x	Digital Zoom Setting*2	p. 47
		Camera Shake Warning	p. 26
		Low Battery	p. 17

\*1: Each mode of the **SCN** mode icon appears (p. 51).

\*2: Zoom powers reflect the combined optical and digital zoom effects. These figures appear when the digital zoom is activated.

- When a Shooting mode setting is changed, the settings appear on the LCD monitor for about 6 seconds even if the LCD monitor is set to Standard (No Information) or Off. (The Shooting mode settings may not appear depending on the camera setting.)
- and the icons in (the shaded area of the chart) appear even when the information view is turned off.
- In addition to the above, the AF frame, spot metering frame, shutter speed, aperture value, recordable images or recordable movie time are displayed as in the example on page 24.
- Setting the shooting mode dial to or modes turns the LCD monitor on regardless of whether it is set to on or off.

- A slow shutter speed has likely been selected because of insufficient lighting if the upper indicator blinks orange after the metering preparations are complete and the camera shake icon (📷) displays in the LCD monitor. Set the flash to  or , or affix the camera to a tripod to shoot.
- After you shoot an image by fully pressing the shutter button, the image displays on the LCD monitor for approximately three seconds (if the review duration is changed, the image is displayed for the selected number of seconds; or if the hold function is activated, the image is displayed until the shutter button is pressed again) (p. 36). Keeping the shutter button fully pressed after shooting, or pressing the **SET** button while the image is displayed will also continue to display the image.

## Playback Mode

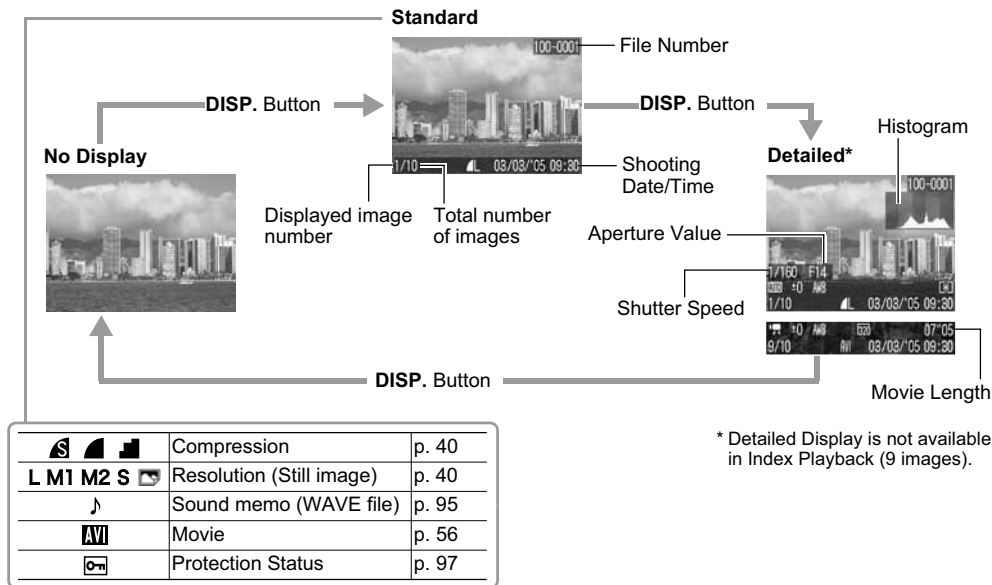

## Icons Displayed in Playback Mode (Detailed Display)

	Shooting Mode	p. 38, 76
-2 ... ±0 ... +2	Exposure Compensation	p. 83
	White Balance	p. 84
	Photo Effect	p. 88
	ISO Speed	p. 87
	Flash	p. 42
	Macro Mode	p. 44
	Manual Focus	p. 91
	Metering Mode	p. 82
	Resolution (Movies)	p. 40
	Low Battery	p. 17

In addition to the above, the shutter speed, aperture value, histogram and recorded movie time are displayed as in the example in the figure on page 27.

\*1: Each mode of the **SCN** mode icon appears (p. 51).

\*2: appears even in No Display mode.

The following information may also appear with some images.

	An audio file other than a WAVE file, or a file with unrecognized format, is attached.
	JPEG image not conforming to Design rule for Camera File System Standards.
	RAW image.
	Unrecognized data type.



- The on/off setting of the LCD monitor display mode is memorized when the camera is turned off. When the camera is turned on again it assumes the last mode. However, when the LCD monitor is turned on and the “Change the batteries” message appears, the LCD monitor may not automatically turn on the next time the camera is started.
- While a recorded image is displayed on the LCD monitor, you can check the exposure with the graph (see *About the Histogram* (p. 29)) that shows the distribution of the brightness data. If the exposure requires adjustment, set the exposure compensation and re-shoot. (Press the **DISP.** button if the histogram and other information are not shown.)

- Please note that image information recorded by this camera may not display correctly on other cameras and image information recorded by other cameras may not display correctly on this camera.

#### About the Histogram

- The histogram is a graph that allows you to judge the brightness of the shot image. The greater the bias toward the left in the graph, the darker the image. The greater the bias toward to the right, the brighter the image. If the image is too dark, adjust the exposure compensation to a positive value. Similarly, adjust the exposure compensation to a negative value if the image is too bright (p. 83).

#### Sample Histograms



Dark image



Balanced image



Bright image

## Turning the Power On/Off

### Turning the Camera On

- 1 Press the Power button until the power lamp lights green (p. 14).

### Shooting Mode

- Current shooting settings will appear in the LCD monitor.



Current shooting settings will disappear in approximately 6 seconds when the LCD monitor is set to Standard (No Information) or Off (p. 24).

### Playback Mode

- The LCD monitor displays an image.

## Turning the Camera Off

- 1 Press the Power button again to turn the power off.



- You will hear a start-up sound and see the start-up image when the power is turned on. (To change the start-up sound and image, see pages 71, 74 and 117.)
- The start-up image does not appear when the LCD monitor is Off in Shooting mode or the **A/V OUT** terminal is connected to a TV.

### Turning on the camera without the start-up sound

- Hold the **MENU** button while pressing the Power button. This will set the [Mute] setting to [On] and silence the operation sound and the shutter sound. This is convenient when you wish to shoot silently. However, the warning signal beeps even when the [Mute] setting is [On].



## Power Saving Function

This camera is equipped with a power saving function. Depending on the power saving setting, the camera may power down or the LCD monitor may go off automatically.

### ● Auto Power Down

#### [On]: Shooting mode:

Powers down approximately 3 minutes after the last time a camera control is accessed.

#### Playback mode:

Powers down approximately 5 minutes after the last time a camera control is accessed.

#### Connected to a Printer:

Powers down approximately 5 minutes after the last time a camera control is accessed.

### When the Auto Power Down Function Activates

Pressing the Power button again will restore power.

[Off]: The power saving function does not activate.

### ● Display Off (only in shooting mode)

The LCD monitor automatically shuts off approximately 1 minute\* after the last time a camera control is accessed.

\* This time can be changed (p. 72).

### When the Display Off Function Activates

The LCD monitor display turns back on by pressing any button other than the Power button, or by altering the vertical or horizontal orientation of the camera.



The power saving function will not activate during Auto Play or during a computer connection (p. 96, 106).

## Switching between Shooting and Playback

You can quickly switch between Shooting mode and Playback mode. This is convenient when you wish to shoot again after checking or erasing an image immediately after it is shot.

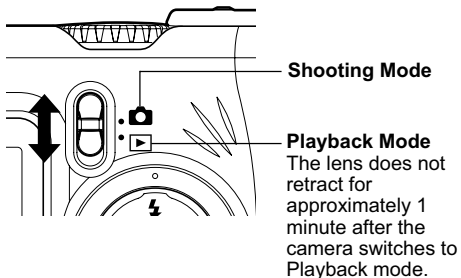



## Shooting Mode

- Slide the mode switch to .

## Playback Mode

- Slide the mode switch to .
  - When a printer (sold separately) is connected, images can be printed (see the *Direct Print User Guide*).
  - When the camera is connected to a computer, recorded images can be downloaded to and viewed with a computer (p. 106).



When a printer (sold separately) is properly connected, the ,  or  icon appears on the LCD monitor.

See *Functions Available in Each Shooting Mode* (p. 159) at the end of this manual to find out which settings can be changed in which Shooting modes.

## **AUTO** Auto Mode

**Mode Dial** **AUTO**

In this mode, all you have to do is press the shutter button and let the camera do everything else.

- 1 Check that the camera is in Shooting mode (p. 32).**
- 2 Turn the shooting mode dial to **AUTO**.**
- 3 Aim the camera at the subject you wish to shoot.**

## **4 Use the zoom lever to achieve the desired composition (relative subject size in the viewfinder).**

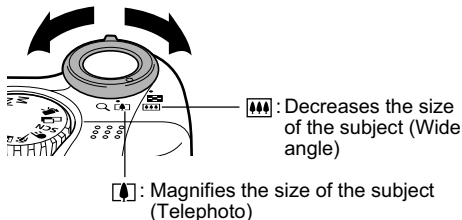

- The angle of view can be adjusted within the 35 to 140 mm range, in 35mm film equivalent.
- When the LCD monitor is on, the combined use of the digital zoom and optical zoom enables magnified shooting up to the following magnification (*Digital Zoom* (p. 47)).  
PowerShot A520: approx. 14x  
PowerShot A510: approx. 13x

## **5 Press the shutter button halfway.**

- The shutter button has a two-stage action.

## Pressing Halfway

Pressing halfway automatically sets the exposure and focus.

- Two beeps will sound when the camera has finished metering, and the upper indicator will light green or orange. If the LCD monitor is on, the AF frame will appear green.
- The lower indicator will blink yellow and the beep will sound one time if the subject is difficult to focus on.

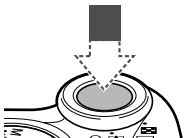

## 6 Press the shutter button all the way.

### Pressing Fully

Pressing fully releases the shutter.

- You will hear the shutter sound when the shot is complete. Do not move the camera until you hear this sound.
- The upper indicator blinks green while data is recorded onto the memory card.
- The picture appears for approximately three seconds on the LCD monitor, if it is on.

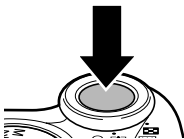

- See page 159 for settings that can be changed in this mode.
- With the Review function, you can change the length of time images show on the LCD monitor after shooting, or set it so they do not show at all (p. 36).
- If the indicator blinks orange or yellow while you press the shutter button halfway, you can still press fully to take the shot.
- Images are first saved into the camera's internal memory before being recorded onto the memory card, allowing the next images to be taken immediately as long as sufficient space is available in the internal memory.
- The beep and shutter sound can be set [On/Off] in the [Set up] menu (p. 70).
- Even when the shutter sound is set to [1], [2], [3] (On) (p. 74), no sound will be heard if [Mute] is set to [On].
- There is no shutter sound in movie mode.
- Shots cannot be taken while the flash is charging.

## Shooting with the Viewfinder

You can save power by turning the LCD monitor off (p. 24) and using the viewfinder to shoot.

### 1 Compose the image so that the subject appears in the center of the frame in the viewfinder (autofocus range).

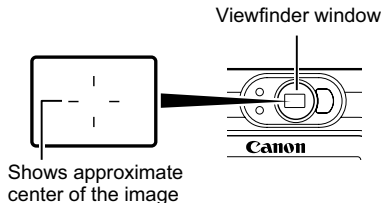

### About the Autofocus Function

This camera employs AiAF (artificial intelligence autofocus) technology, which uses a broad metering field to calculate the focal distance with high precision. It delivers a crisp focus even when the photographic subject is slightly off-center.

### Image Seen in Viewfinder vs. Recorded Image

When shooting an image, a larger range than the one visible in the viewfinder usually gets recorded. You can confirm the actual range that will be recorded in the LCD monitor. In addition, due to the viewfinder's specification, the range visible in the viewfinder may actually differ from the actual recorded image. The closer the subject is to the lens, the more noticeable the difference will be. In some cases, portions of images shot up close that appear in the viewfinder will not appear in the recorded image. You are recommended to use the LCD monitor during macro photography (p. 44).

**AF-assist Beam**

- The AF-assist beam will sometimes emit when the shutter button is pressed halfway to assist focusing in certain conditions, i.e. dark conditions.
- The AF-assist beam can be turned off (p. 69).  
For example, if animals are your subject, turn off the beam when shooting in the dark to avoid startling them.  
However, please keep in mind the following facts.
  - If the AF-assist beam is turned off, it may become more difficult for the camera to focus in dark conditions.
  - The red-eye reduction lamp may emit when you press the shutter button halfway even if the AF-assist beam is turned off.
- In order to prevent any lamp from emitting before the flash fires, set both the red-eye reduction function and the AF-assist beam to [Off] in the Shooting menu.

**Reviewing an Image Right after Shooting**

**Mode Dial** AUTO P Tv Av M      SCN 

Right after a shot is taken, the image displays on the LCD monitor for approximately 3 seconds (the duration of display can be changed.) In addition, the image will keep on displaying regardless of the review duration setting by performing one of the following operations.

- **Keeping the shutter button fully pressed**
- **Pressing the SET button while the image is displayed\***

Press the shutter button halfway again to stop displaying it so that you can shoot the next image.



You can perform the following while images are displayed.\*

- Erase the image (p. 65).
- Display the image's information (p. 27).
- Magnify the image (p. 59) (When pressing the **SET** button while the image is displayed.)

\* Not available in  (Stitch Assist) mode.

## Changing the Image Display Duration

The image review time can be set to [Off], any time in the range of 3 to 10 seconds, or [Hold].

### 1 Press the MENU button.

- The [ ] (Rec.) menu appears.

### 2 Select (Review) using the **↑** or **↓** button.



### 3 Select a duration setting using the **←** or **→** button and press the MENU button.

- With the [Off] option, the image will not display.
- With the [3 sec.] to [10 sec.] options, the image will appear for the time selected even if you release the shutter button.
- If [Hold] is selected, the image will keep on displaying until the next time the shutter button is pressed.

- Another shot can be taken by pressing the shutter button even while an image is displayed.

## Using the Mode Dial (Image Zone)

Settings fitting the shooting conditions of your subject can easily be set using the shooting mode dial.

### Portrait



Use this mode when you want the subject to appear sharp and the background to blur.

### Movie

Use this mode to shoot movies. Sound is also recorded simultaneously (p. 56).

### Stitch Assist



Use this mode when taking shots that you want to combine into a panorama (p. 49).

### SCN Special Scene



Select from 8 scene modes to shoot with the most appropriate settings for the scene (p. 51).

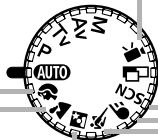

### Landscape



Use this mode to shoot landscape scenes.

### Night Scene



Use this mode to capture human subjects against the backdrop of an evening sky or night scene. The flash is directed at the person and the shutter speed is slow, so both the person and the background can be beautifully shot.

### Fast Shutter



Use this mode to shoot fast moving objects.

### Slow Shutter



Use this mode to shoot moving objects to make them appear blurred, such as river rapids.



# 1 Turn the shooting mode dial and set the icon of the mode you wish to use to .

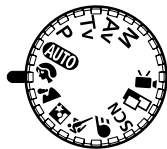

- Shooting procedures are the same as for the **AUTO** mode (p. 33).



## and Shooting Modes

Always use a tripod to prevent camera shake.



- See page 159 for settings that can be changed in each mode.

### • **Tips for each function:**

#### **Portrait Mode**

- You can achieve a better blurring effect of the background by making sure the upper half of your subject fills the entire LCD monitor or viewfinder.
- You can enhance the blurring effect of the background even more by setting the lens to its telephoto end setting.

#### **Landscape Mode**

- The  icon (camera shake warning) may appear on the LCD monitor since slower shutter speeds are frequently used in this mode. If this happens, affix the camera to a tripod.

#### **Night Scene Mode**

- The shutter speed slows down. Even if you use the flash, tell your subjects not to move for a few moments.
- If the Night Scene mode is used to shoot mid-day shots, the same effects as with the **AUTO** mode can be obtained.

#### **Fast Shutter**

- Noise in the recorded image may increase if you shoot in dark conditions.



## 2 Select **L\*** using the **↑** or **↓** button.

\* The current setting is displayed.



Example:  
PowerShot A510

## 3 Select the resolution you wish to set using the **←** or **→** button.

Excluding 



Number of recordable images  
(Only displayed when the resolution or compression is selected)

## 4 Press the SET button.

## 5 Select the compression you wish to set using the **←** or **→** button.



- You can shoot the image right after selecting settings by pressing the shutter button. This screen will appear again, once the image is shot.

## 6 Press the FUNC. button.



- *Image Data Size (Estimated)* (p. 146)
- *Memory Cards and Estimated Capacities (Recordable Images)* (p. 145)

## ⚡ Using the Flash

**Mode Dial** AUTO P Tv Av M SCN\*

\* In (Fireworks), the flash is prohibited.

Use the flash according to the guidelines below.

	Auto with red-eye reduction	The flash fires automatically as required by the lighting level, and the red-eye reduction lamp fires each time the main flash fires.
	Auto	The flash fires automatically as required by the lighting level.
	Flash on with red-eye reduction	The red-eye reduction lamp and the flash always fire.
	Flash on	The flash always fires.
	Flash off	The flash does not fire.

### 1 Press the button to switch between flash modes.

- The selected flash mode appears on the LCD monitor.



- You can switch between settings by pressing the button.

**When the red-eye reduction function is on**



**When the red-eye reduction function is off**



- This operation may not work in certain Shooting modes (p. 159).

## 2 Shoot the image.

- The flash will fire if the upper indicator lights orange when the shutter button is pressed halfway. (Does not fire in .)
- Shooting procedures are the same as for the **AUTO** mode (p. 33).



When shooting with a high ISO sensitivity and using the flash, there is more of a chance of overexposure the closer you are to the subject.



- When shooting in any mode other than **M** mode, the flash fires with automatic adjustments.
- The flash fires twice. A pre-flash will fire and will be followed by the main flash. The pre-flash is used by the camera to obtain the subject's exposure data so that the main flash can be set to the optimal intensity for the shot.
- In **M** mode, the [Flash Output] option can be changed and the flash fires with the manually set adjustments (p. 89).
- The fastest shutter speed for flash synchronization is 1/500 second. The camera automatically resets the shutter speed to 1/500 second if a faster speed is selected.
- Shots cannot be taken while the flash is charging.
- The flash may take approximately 15 seconds to charge in some cases. The LCD monitor, if it is on, will go off when the indicator blinks orange while charging. The LCD monitor will come back on after the indicator lights orange when charging is completed. The charging time will vary depending on usage and remaining battery power.

- The flash setting is saved when the camera is turned off in the **P**, **Tv**, **Av** and **M** Shooting modes.

## Setting the Red-eye Reduction Function

The red-eye reduction lamp fires when the flash is used in dark areas. This reduces light reflecting back from the eyes and making them appear red.

### 1 In the [ (Rec.)] menu, set (Red-eye) to [On].

- appears on the LCD monitor.





### ● Red-eye Reduction

For this mode to be effective, the subject must be looking right at the red-eye reduction lamp. Try asking them to look directly at the lamp. Even better results can be obtained by shooting with the lens set to a wide angle, increasing the lighting in indoor settings or approaching closer to the subject.

- The red-eye reduction function cannot be set when the Special Scene mode (p. 51) is set to (Fireworks).

## Macro Mode

**Mode Dial** AUTO P Tv Av M

\* Macro mode is not available in and .

Use the macro mode when the distance between the lens and the subject is in the range of 5 to 45 cm (2.0 in. to 1.5 ft.) at wide angle end and 30 to 45 cm (11.8 in. to 1.5 ft.) at telephoto end.

Use to take close-up shots of flowers or small objects.

**1** Press the **DISP.** button to turn the LCD monitor on.

**2** Press the button.

- The icon appears on the LCD monitor.
- Pressing the button again cancels the macro mode.



**3** Shoot the image.

- The lower indicator will light yellow when the shutter button is pressed halfway.
- Shooting procedures are the same as for the **AUTO** Mode (p. 33).



- Always use the LCD monitor to compose images in macro mode. Shooting with the viewfinder is possible, however, part of the image may not appear in the actual shot (p. 35).
- When the lens is zoomed out to the wide angle end\*<sup>1</sup>, the recordable area is approx. 60 x 44 mm (2.4 x 1.7 in.), and at telephoto end\*<sup>2</sup>, it is approx. 84 x 63 mm (3.3 x 2.5 in.).  
When the zoom position is located between the telephoto end and the wide angle end, the distance between the front of the lens and the subject will be the same as the telephoto end.
- The exposure may not be optimal when the flash is used in macro mode.

\*<sup>1</sup> Closest focal distance.

\*<sup>2</sup> Maximum optical telephoto setting.

## Self-timer

**Mode Dial** AUTO P Tv Av M SCN

\* The cannot be set in and modes.



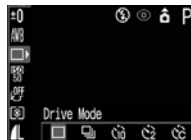

- 1 Press the FUNC. button and select \*(Drive Mode) using the or button.**





\* The current setting is displayed.

- 2 Select , , or using the or button and press the FUNC. button.**

- When is selected, the shutter release will be delayed for 10 seconds, and when is selected, the shutter release will be delayed for 2 seconds, after you press the shutter button all the way.



- When  is selected, pressing the **SET** button will allow you to set the start time (0 to 10 seconds) and the number of shots (1 to 10 shots). Select the setting item using the  or  button and change its value using the  or  button.

### 3 Shoot the image.

- When  is selected, the self-timer lamp starts blinking when the shutter button is pressed all the way. The self-timer sounds and the blinking gets faster two seconds before the shutter activates.
- When  is selected, the self-timer lamp blinks fast from the beginning. The shutter activates in two seconds.
- When  is selected, the self-timer lamp will blink during shots, and self-timer sounds will sound as follows. If you set multiple shots to be taken, the self-timer will sound only for the first shot.
  - The self-timer will not sound when set to [0 sec.].
  - The self-timer will not sound when set to [1 sec.], but the beeps will sound.



- When the self-timer is set between 2 to 10 sec., the self-timer will sound 2 seconds before the shutter activates.
- Shooting procedures are the same as for the **AUTO** mode (p. 33).



- You can change the self-timer sound by changing the setting in [Self-timer Sound] in the [ (My Camera)] menu (p. 74).
- When  is selected and the number of [shot] is set to two or more,
  - if the internal memory is full, the interval between shots may lengthen.
  - if the flash is to be used, the interval between shots will lengthen to accommodate the flash recharge time.
- See *Photo Tips and Information* (p. 151).



## Digital Zoom

**Mode Dial** **AUTO** P Tv Av M     **SCN**

Images can be zoomed with the combined optical and digital zoom functions as follows.  
PowerShot A520:

Approx. 5.7x, 7.1x, 8.9x, 11x and 14x

PowerShot A510:

Approx. 5.1x, 6.4x, 8.0x, 9.8x and 13x

### 1 Press the DISP. button to turn the LCD monitor on.



### 2 In the [ (Rec.)] menu, select (Digital Zoom).

- See *Selecting Menus and Settings* (p. 66).



### 3 Select [On] using the or button and press the MENU button.

### 4 Press the zoom lever toward .

- The lens will zoom to the maximum optical telephoto setting and stop. Press the zoom lever toward  again to further zoom the image digitally.
- Press the lever toward  to zoom back out.



The combined magnifications of the optical zoom and digital zoom are displayed.

### 5 Shoot the image.

- Shooting procedures are the same as for the **AUTO** mode (p. 33).







The digital zoom cannot be used when the LCD monitor is off.



- Images become coarser the more they are digitally zoomed.
- Since camera shake may become a factor when using the digital zoom, the use of a tripod is recommended.



## Continuous Shooting

**Mode Dial** P Tv Av M         SCN

Use this mode to shoot successive shots while the shutter button is pressed.

- Continuous shooting speed is as follows\*.  
PowerShot A520: Approx. 1.9 shots per second  
PowerShot A510: Approx. 2.3 shots per second
- \* Large/Fine mode with LCD monitor off (These figures reflect Canon's testing standard. The figures will vary depending on the subject and shooting conditions.)

**1 Press the FUNC. button.**

**2 Select \*(Drive Mode) using the  or  button.**

\* The current setting is displayed.



**3 Select  using the  or  button and press the FUNC. button.**

**4 Press the shutter button halfway to lock the focus.**

**5 Press the shutter button all the way to shoot.**

- Shooting will stop when the shutter button is released.



- The interval between shots may lengthen somewhat when the internal memory becomes full.
- The flash can be used, but the interval between shots will lengthen to accommodate the flash recharge time.

## ☑ Shooting Panoramic Images (Stitch Assist)

Mode Dial 

Stitch Assist can be used to shoot overlapping images that can later be merged (stitched) to create one panoramic image on a computer.

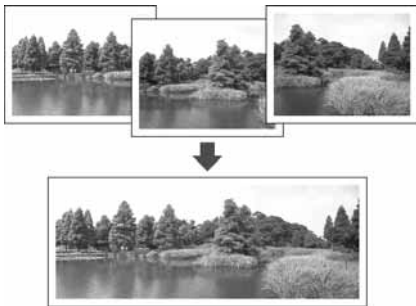

To merge the images on a computer, use PhotoStitch, one of the supplied software programs.

## Framing a Subject

The PhotoStitch program detects the overlapping portions of adjoining images and merges them. When shooting, try to include a distinctive item (landmark) in the overlapping portions.

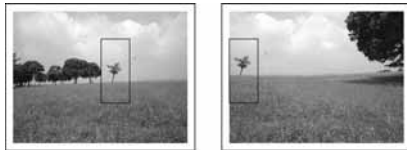



- Compose each frame so that it overlaps 30 to 50% of the adjoining image. Try to keep the vertical misalignment to within 10% of the image height.
- Do not include moving items in the overlap.
- Do not try to stitch images that include both distant and close items. Objects may appear warped or doubled up.
- Make the brightness in each image consistent. The final image will appear unnatural if the difference in brightness is too great.

- To shoot landscapes, swivel (pan) the camera around its own vertical axis.
- To shoot close-ups, slide the camera over the subject, keeping it parallel to the subject as you move it.

## Shooting

Images can be shot in the following 2 sequences in Stitch Assist mode.

	Left → Right	Left to right horizontally
	Left ← Right	Right to left horizontally

### 1 Turn the Shooting mode dial to .

- The LCD monitor will turn on.

### 2 Select the shooting sequence using the or button and press the SET button.

- The shooting sequence is set.



- You can also press the shutter button directly to shoot without pressing the **SET** button.

### 3 Shoot the first image.



- The exposure and white balance settings are set and locked with the first image.

### 4 Compose and shoot the second image so that it overlaps the first.

- Minor discrepancies in the overlapping portions can be corrected when the images are stitched together.



Sequence 

- Use the  or  button to check or retake the recorded images.

### 5 Use the same procedures to shoot the remaining images.

- A maximum of 26 images can be recorded.

### 6 Press the SET button after the last shot.



- A custom white balance setting (p. 85) cannot be set in  mode. To use a custom white balance setting, first set it in another Shooting mode.
- The settings in place for the first image are locked in and cannot be changed for subsequent shots.
- A TV cannot be used as the monitor for shooting in this mode.











See page 159 for settings that can be changed in this mode.

## SCN Special Scene Mode

**Mode Dial** SCN

By simply selecting one of the following 8 modes, you can shoot the image with the most appropriate settings for the scene.

 Foliage	Appropriate for shooting images with flowers, leaves or trees to enhance color.
 Snow	Appropriate for shooting the subject against the backdrop of snowy mountains while preventing dark subjects and bluish backgrounds.
 Beach	Appropriate for shooting scenes by the sea or on sunlit sandy beaches while preventing dark subjects.
 Fireworks	Appropriate for shooting fireworks clearly with the optimal exposure.
 Underwater	Appropriate for shooting images with the Waterproof Case WP-DC60 (sold separately). This mode uses an optimal white balance setting to reduce bluish tones and record images with natural hues. The flash is controlled to fire as seldom as possible.

 Indoor	Prevents camera shake and maintains the subject's true color when shooting under fluorescent or tungsten lighting. The exposure is regulated so as to avoid the use of flash as much as possible.
 Kids & Pets	Allows you to capture subjects that move around, such as children and pets, without missing photo opportunities.
 Night Snapshot	Use this to take snapshots of people against twilight or night backgrounds to reduce the effects of camera shake even without using a tripod.

## 1 Turn the shooting mode dial to SCN (Special Scene mode).







- The current Scene mode screen is displayed.

## 2 Select the scene you wish to shoot using the ◀ or ▶ button and shoot the image.



- The name of the Scene mode is displayed for approximately six seconds each time you change the mode.
- Shooting procedures are the same as for the **AUTO** mode (p. 33) excluding .

- For the shooting procedures of , see the *Waterproof Case User Guide* included with the Waterproof Case WP-DC60 (sold separately).

**Foliage****Snow****Beach****Fireworks****Night Snapshot****Kids & Pets****Indoor****Underwater**

- In  mode, the shutter speed slows down. Use a tripod to avoid camera shake.
- In , ,  and  modes, the ISO speed may increase and cause noise in the image.
- In  mode, shoot subjects in the following range: 1 to 5 m (3.3 to 16 ft.) (telephoto end) or 1 m (3.3 ft.) – infinity (other zooming positions).



- See page 159 for settings that can be changed in this mode.
- In  mode, using the LCD monitor is recommended.
- Results may vary depending on the subject.
- When shooting images underwater, always turn the power off before inserting the camera into the Waterproof Case WP-DC60 (sold separately).
- In  and  modes, using the Waterproof Case WP-DC60 (sold separately) is recommended.

## Postcard Print Mode

**Mode Dial** **AUTO** P Tv Av M SCN

You can shoot images with the optimal resolution and compression for postcard size printing.

- When printing standard image data to postcard size, sometimes the top and bottom sides may not get printed.
- By shooting images in the Postcard Print mode, you can check the printing area (vertical/horizontal ratio of 3:2) beforehand. In addition, the resolution locks to **M1** (1600 x 1200) and the compression locks to the (Fine) setting, rendering smaller data sizes.

### 1 Press the FUNC. button.

### 2 Select \* using the or button.

\* The current setting is displayed.



### 3 Select (Postcard) using the or button.

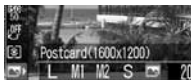

- You can shoot the image right after selecting settings by pressing the shutter button. The menu displays again after the shot, allowing you to change the settings easily.

### 4 Press the FUNC. button.

### 5 Shoot the image.

- When you press the shutter button halfway, the area that will not get printed (the top and bottom sides) grays out.
- Shooting procedures are the same as for the **AUTO** mode (p. 33).



Selecting cancels the [On] setting of the digital zoom.



- This setting is not available with certain Shooting modes. Please refer to *Functions Available in Each Shooting Mode* (p. 159).
- When [Date Stamp] (p. 55) is set to [Date] or [Date & Time], icon appears in the LCD monitor.
- For printing instructions, refer to the *Direct Print User Guide*.





## Embedding the Date in the Image Data



You can embed the date on image data when  (Postcard Print mode) is selected. The date will be printed on your images even if it has not been set with a computer or printer.

- Ensure that the camera's date/time is set beforehand (p. 22).
- You cannot embed the date on image data when  (Postcard Print mode) is not selected.

**1** Check that  appears on the LCD monitor.

**2** Select  (Date Stamp) in the [ (Rec.)] menu.

- See *Selecting Menus and Settings* (p. 66).

**3** Select [Off], [Date] or [Date & Time] using the  or  button.

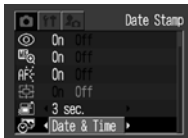

- See *Setting the Date/Time* (p. 22).
- If you do not want to embed the date on image data, select [Off].

**4** Press the MENU button.

**5** Shoot the image.



- Shooting procedures are the same as for the  mode (p. 33).



- The Date Stamp cannot be deleted from the image data once it has been set.
- When using a Compact Photo printer (SELPHY CP series) or Card Photo printer, a portion of the date may not get printed if the credit card size print (54 mm x 86 mm (2.1 x 3.4 in)) is selected.

## **Movie Mode**

**Mode Dial** 

Use this mode to shoot movies. The resolution can be set to [ (640 x 480)], [ (320 x 240)] or [ (160 x 120)] (p. 40).



### **1 Turn the shooting mode dial to .**

- The LCD monitor turns on and displays the maximum recording time (in seconds).

### **2 Press the shutter button all the way.**

- Shooting and sound recording starts simultaneously.
- During the shooting a red circle appears in the upper right of the LCD monitor.

### **3 Press the shutter button all the way to stop recording the movie.**

- The maximum length of individual movie clips is 30 seconds at the  setting (10 frames/second) and 3 minutes at the  and  settings (15 frames/second).

\* Recording times vary by the memory card. See *Memory Cards and Estimated Capacities (Recordable Images)* (p. 145).

The maximum length of individual movie clips may vary with the subject and shooting conditions. Recording will automatically stop when the maximum is reached or when the memory cards runs out of free capacity.



- The recording time may not display properly during shooting or filming may stop unexpectedly with the following types of memory cards.
  - Slow recording cards
  - Cards formatted on a different camera or a computer
  - Cards which have had images recorded and erased repeatedly
 Although recording time may not display properly during shooting, the movie will be recorded correctly on the memory card. Recording time will display properly if you format the memory card in this camera (excluding slow recording memory cards).

- You are recommended to use a memory card that has been formatted in your camera to shoot movies (p. 19). The card supplied with the camera may be used without further formatting.
- Be careful not to touch the microphone while shooting.
- During shooting, do not press any button other than the shutter button. These operation sounds will also be recorded.
- The AE, AF, white balance and zoom settings are set and locked to the settings of the first frame.
- After a shot, the upper indicator blinks green while the movie clip is being written to the memory card. You cannot shoot again until it stops blinking.



- See page 159 for settings that can be changed in this mode.
- Sound is recorded monaurally.
- There is no shutter sound in movie mode.
- QuickTime 3.0 or higher is required to playback movies (File type: AVI/ Compression method: Motion JPEG) on a computer. (QuickTime (for Windows) is bundled on the supplied Canon Digital Camera Solution Disk. On the Macintosh platform, QuickTime 3.0 or later is generally bundled with Mac OS 8.5 or later operating system.)

## Displaying Images Individually (Single Image Playback)





You can view the recorded images on the LCD monitor.

### 1 Slide the mode switch to .

- The last recorded image appears (single image playback).



### 2 Move between images using the or button.

- Use the  button to move to the previous image and the  button to move to the next. Holding the  or  button moves more rapidly between the images, but the images will not appear as clearly.



You may not be able to play back images that have been shot with another camera or edited on a computer with other software applications.



- Press the **DISP.** button to show the information of the displayed image (p. 27).
- Press the  button to quickly delete the displayed image (p. 65).

## Q Magnifying Images









Images can be magnified up to approximately 10 times in single image playback.

**1** Slide the mode switch to .

**2** Press the zoom lever toward .



Approximate position

- You can move around the magnified image using the , ,  or  button.
- Pressing the **SET** button switches to image advance mode. Press the  or  button to display the preceding or next image at the same level of magnification. (However, keeping on pressing the  or  button cannot switch the images more quickly.) Pressing the **SET** button again cancels image advance mode.

## Canceling the Magnified Display

**1** Press the zoom lever toward .

- Pressing the **MENU** button cancels magnification immediately.



Movie frames and index playback images cannot be magnified.



You can magnify an image while it is displayed on the LCD monitor in Shooting mode immediately after the image is shot (p. 36).

## ▣ Viewing Images in Sets of Nine (Index Playback)

Up to 9 images can be viewed at once in index playback.

**1** Slide the mode switch to .

**2** Press the zoom lever toward .

- 9 images appear at once (index playback).

**3** Change the image selection using the , ,  or  button.

Pressing the  button in this row displays the previous set of 9 images.

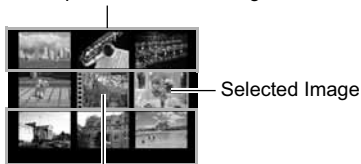

Movie

Pressing the  button in this row displays the next set of 9 images.

**4** Press the zoom lever toward .

- Index playback cancels and the display reverts to single image playback.



Press the **DISP.** button to show the information for the displayed image (p. 27).





## Jumping between Images

The display can be advanced or set back 9 images in index playback.

### 1 Press the zoom lever toward while in index playback (p. 60).

- The jump bar appears.

### 2 Change the image selection.

- Jump 9 images back or forward using the  or  button.
- Pressing the  or  button while holding the SET button displays the first set or last set of 9 images.



Jump Bar

### 3 Press the zoom lever toward .

- The jump bar disappears and the camera returns to index playback.
- If you press the zoom lever once more toward , the camera returns to single image playback.

## Viewing/Editing Movies

### Viewing Movies

You can playback the movies shot in  mode.



### 1 Slide the mode switch to .

- Movies cannot be viewed in index playback.

### 2 Select a movie using the or button and press the SET button.

- A movie displays with the  icon on it.
- The movie playback panel appears.

### 3 Select (Play) using the or button and press the SET button.

- The movie and sound will play.
- You can adjust the volume using the  or  button.



Volume

Movie Playback Panel





- When a movie has finished playing, it will display the last frame.  
If the **SET** button is pressed in this state, the camera will revert to the movie playback panel. If the **SET** button is pressed again, the movie will start playing from the first frame.

### Pausing and Resuming Play

- Press the **SET** button to pause the movie. Press it again to resume.

### Fast Forwarding/Rewinding

- Select one of the following operations using the **←** or **→** button and press the **SET** button.

-  **(Exit)** : Returns to single image playback
-  **(First Frame)** : Displays the first frame
-  **(Previous Frame)**: Returns to the previous frame (Rewinds if the **SET** button is held down)
-  **(Next Frame)** : Proceeds to the next frame (Fast forwards if the **SET** button is held down)
-  **(Last Frame)** : Displays the last frame



You may experience frame dropping and audio breakup when playing back a movie on a computer with insufficient system resources.



- The volume at which movies play back can also be adjusted in the Set up menu (p. 71).
- If [Mute] (p. 70) is set to [On] in the Set up menu, the volume setting returns to 0 but it can be adjusted using the **↑** or **↓** button.
- Please adjust the audio sound level on the TV when viewing movies on a TV.

### Editing Movies

You can delete unwanted portions at the beginning or end of a movie clip.

- 1 Select the movie you wish to edit and press the SET button.**
  - See *Viewing Movies* (p. 61).
- 2 Select  (Edit) using the ← or → button and press the SET button.**
  - The movie editing panel and the movie editing bar appear.



### 3 Select an editing method using the **↑** or **↓** button.

- **[Cut Beginning]**: Deletes frames from the beginning of the movie.
- **[Cut End]**: Deletes frames from the end of the movie.
- **[Exit]**: Reverts to the movie playback panel.

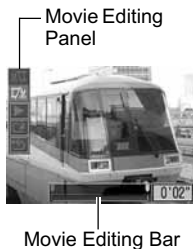

### 4 Select the range you wish to delete using the **←** or **→** button.



### 5 Select **[Play]** using the **↑** or **↓** button and press the **SET** button.

- The temporarily edited movie will start playing.
- The movie will stop if you press the **SET** button while it is playing.

### 6 Select **[Save]** using the **↑** or **↓** button and press the **SET** button.

- When **[Save]** is selected, the edited movie is not saved and the camera reverts to the movie playback panel.



### 7 Select **[Overwrite]** or **[New File]** using the **←** or **→** button and press the **SET** button.

- **[Overwrite]**: Saves the edited movie under the same name as the original movie. The original data is deleted.
- **[New File]**: Saves the edited movie under a new name. The original data is left unchanged.
- When there is not enough space left on the memory card, only the overwrite function is available. If this happens, a small **▲** appears on the counter of the movie editing bar.





- Protected movies and movies with an original length of less than one second cannot be edited (p. 97).
- It may take approximately 3 minutes to save an edited movie. If the battery runs out partway through, edited movie clips cannot be saved. When editing movies, it is recommended to use new AA size alkaline batteries or fully charged AA-size NiMH batteries (sold separately), or the AC Adapter Kit ACK800 (sold separately) (p. 131).



Movies with an original length of 1 second or more can be edited in 1-frame units.



Please note that erased images cannot be recovered. Exercise adequate caution before erasing an image.



## Erasing Images Individually

**1** Slide the mode switch to .

**2** Select the image you wish to erase using the **←** or **→** button and press the  button.

- A confirmation screen appears.

**3** Select **[Erase]** using the **←** or **→** button and press the **SET** button.

- To cancel instead of erasing, select **[Cancel]** and press the **SET** button.



Protected images cannot be erased with this function (p. 97).

## Erasing All Images

**1** In the **[▶] (Play)** menu, select  (**Erase all**) and press the **SET** button.

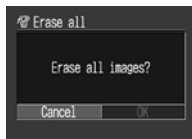

- A confirmation screen appears.

**2** Select **[OK]** using the **←** or **→** button and press the **SET** button.

- To cancel instead of erasing, select **[Cancel]** and press the **SET** button.



- The **[Erase all]** function erases all the image data recorded on the memory card.
- Protected images cannot be erased with this function (p. 97).
- To erase the images and all other data recorded on the memory card, see *Formatting Memory Cards* (p. 19).

## Selecting Menus and Settings

### Selecting Settings with the FUNC. Button (Shooting Mode Only)

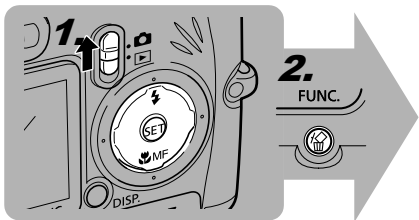

- 1 Slide the mode switch to .
- 2 Press the FUNC. button.
- 3 Use the or button to select a FUNC. menu item.
- 4 Use the or button to select the setting contents.
- 5 Press the FUNC. button.
- 6 Shoot the image.

3. Select a FUNC. menu item using the or button.
4. Select the setting contents using the or button.

Exposure Compensation ( $\pm 0$ ) (p. 83)



White Balance (AWB) (p. 84)



Drive Mode ( ) (p. 45, 48)

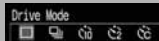

ISO Speed (ISO) (p. 87)



Photo Effect (OFF) (p. 88)



Metering Mode ( ) (p. 82)

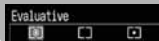

Flash Output (p. 89)

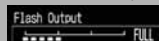

Resolution (L) (p. 40)



Example: PowerShot A510

Resolution (Movies) ( ) (p. 40)



Compression ( ) (p. 40)



Items in ( ) show default settings.

5.

FUNC.



6.

Shoot the image

## Selecting Settings with the MENU Button

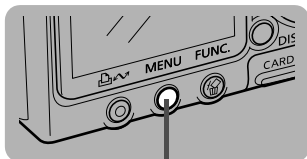

Shooting Mode

Playback Mode

**1** Press the MENU button.

**2** Use the **←** or **→** button to switch between menus.

- You can also switch between menus using the zoom lever.

**3** Use the **↑** or **↓** button to select a menu item.

**4** Use the **←** or **→** button to select the setting contents.

**5** Press the MENU button.

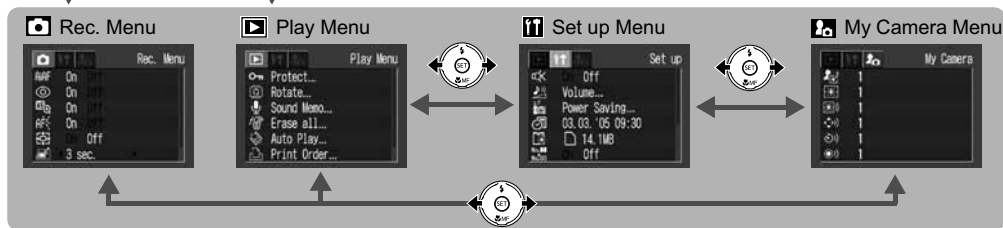







- For items with [...] next to them, press the **SET** button and select the settings from the next displayed menu. Once the settings are complete, press the **SET** button again to enable the new settings.
- In the Shooting mode, you can also close the menu by pressing the shutter button halfway.



- Some menu items may not be available for selection according to the Shooting mode (p. 159).
- You can apply a desired image and sound to **[2]** and **[3]** in the My Camera menu. For details, see the *Registering My Camera Settings* (p. 118) or the *Software Starter Guide*.
- The default of all the settings changed by the menu and button operations except for [Date/Time], [Language] and [Video System] can be restored all at once (p. 75).







## Menu Settings and Default Settings

### Rec. Menu



Menu Item	Setting Content	Reference Page
 <b>AiAF</b>	Sets the camera so that it will either automatically select the AF frame and shoot, or shoot with the AF frame fixed in the center. • <b>On*/Off</b>	81
 <b>Red-eye</b>	Sets whether or not the red-eye reduction lamp fires when the flash fires. • <b>On*/Off</b>	43
 <b>MF-Point Zoom</b>	Sets whether or not the focusing point is magnified when using the manual focus. • <b>On*/Off</b>	91
 <b>AF-assist Beam</b>	Sets whether or not the AF-assist beam is activated as needed when using the auto focus. • <b>On*/Off</b>	36
 <b>Digital Zoom</b>	Sets whether or not the digital zoom combines with the optical zoom to zoom images. • <b>On/Off*</b>	47
 <b>Review</b>	Sets the duration images display on the LCD monitor after the shutter button is released. • <b>Off/3* to 10 sec./Hold</b>	36
 <b>Date Stamp</b>	Sets the date format to be embedded into the image data during Postcard Print mode. • <b>Off*/Date/Date &amp; Time</b>	55

\* Default setting

## Play Menu













Menu Item	Setting Content	Reference Page
 <b>Protect</b>	Protects images from accidental erasure.	97
 <b>Rotate</b>	Rotates images 90 or 270 degrees clockwise in the display.	94
 <b>Sound Memo</b>	Adds sound memos to images.	95
 <b>Erase All</b>	Erases all images from a memory card (excluding protected images).	65
 <b>Auto Play</b>	Plays images automatically one after the other.	96
 <b>Print Order</b>	Sets which images and how many copies will be printed on a printer with the direct print function or at a photo lab service.	100
 <b>Transfer Order</b>	Specifies images before downloading to a computer.	104









## Set up Menu

Menu Item	Setting Content	Reference Page
 <b>Mute</b>	<p>Set [On] to mute the start-up sound, operation sound, self-timer sound and shutter sound all at once. For details, see <i>How the [Mute] setting in the [  (Set up) ] menu and each sound setting in the [  (My Camera) ] menu are related on page 74.</i></p> <ul style="list-style-type: none"> <li>• On/Off *</li> </ul> <p>Turning the power on while pressing the <b>MENU</b> button will set the [Mute] setting to [On]. Note that the warning signal beeps even when the [Mute] setting is [On].</p>	–



\* Default setting



Menu Item	Setting Content	Reference Page
 <b>Volume</b>	Adjusts the volume of the start-up sound, operation sound, self-timer sound, shutter sound, or playback sound after pressing the <b>SET</b> button. The volume cannot be adjusted if [Mute] is set to [On]. <ul style="list-style-type: none"> <li>•  (OFF)</li> <li>•  (1)</li> <li>•  (2)*</li> <li>•  (3)</li> <li>•  (4)</li> <li>•  (5)</li> </ul>	–
	 <b>Start-up Vol.</b> Adjusts the Start-up Sound volume when the camera powers up.	30
	 <b>Operation Vol.</b> Adjusts the Operation Sound volume when any button except the shutter button is operated.	–
	 <b>Selftimer Vol.</b> Adjusts the volume of the self-timer sound played 2 sec. before the shutter is released.	45
	 <b>Shutter Volume</b> Adjusts the Shutter Sound volume when the shutter button is pressed all the way. There is no shutter sound in Movie mode.	34
	 <b>Playback Vol.</b> Adjusts the volume of movie sounds and sound memos.	61, 95







Menu Item	Setting Content	Reference Page
 <b>Power Saving</b>	The [Auto Power Down] and [Display Off] settings can be set by pressing the <b>SET</b> button.	
	 <b>Auto Power Down</b> Sets whether or not the camera automatically powers down after a specified period of time elapses without camera operation. <ul style="list-style-type: none"> <li>• <b>On*</b> /Off</li> </ul>	31
	 <b>Display Off</b> Specifies a period of time before the LCD monitor turns off when no camera operation is performed. <ul style="list-style-type: none"> <li>• <b>10 sec.</b>      • <b>1 min.*</b></li> <li>• <b>20 sec.</b>      • <b>2 min.</b></li> <li>• <b>30 sec.</b>      • <b>3 min.</b></li> </ul>	31
 <b>Date/Time</b>	Sets the date, time and date format.	22
 <b>Format</b>	Formats (initializes) memory cards.	19
 <b>File No. Reset</b>	Sets how file numbers are assigned to images. <ul style="list-style-type: none"> <li>• <b>On/Off *</b></li> </ul>	115
 <b>Auto Rotate</b>	Sets whether or not images shot with the camera held vertically are automatically rotated in the display. <ul style="list-style-type: none"> <li>• <b>On*/Off</b></li> </ul>	92
 <b>Distance Units</b>	Sets the format of the MF indicator's displayed distance units. <ul style="list-style-type: none"> <li>• <b>m/cm*</b></li> <li>• <b>ft/in</b></li> </ul>	91

\* Default setting

Menu Item	Setting Content	Reference Page
 <b>Language</b>	<p>Sets the language used in the menus and messages on the LCD monitor.</p> <ul style="list-style-type: none"> <li>• English* (English)</li> <li>• Deutsch (German)</li> <li>• Français (French)</li> <li>• Nederlands (Dutch)</li> <li>• Dansk (Danish)</li> <li>• Suomi (Finnish)</li> <li>• Italiano (Italian)</li> <li>• Norsk (Norwegian)</li> <li>• Svenska (Swedish)</li> <li>• Español (Spanish)</li> <li>• 简体中文 (Simplified Chinese)</li> <li>• Русский (Russian)</li> <li>• Português (Portuguese)</li> <li>• Ελληνικά (Greek)</li> <li>• Polski (Polish)</li> <li>• Čeština (Czech)</li> <li>• Magyar (Hungarian)</li> <li>• Türkçe (Turkish)</li> <li>• 繁體中文 (Traditional Chinese)</li> <li>• 한국어 (Korean)</li> <li>• 日本語 (Japanese)</li> </ul> <p>You can also change the language in Playback mode by holding the <b>SET</b> button and pressing the <b>MENU</b> button.</p>	23
 <b>Video System</b>	<p>Sets the video output signal standard.</p> <ul style="list-style-type: none"> <li>• NTSC</li> <li>• PAL</li> </ul>	115

## Customizing the Camera (My Camera Settings)

You can select the theme, start-up image and sound, operation sound, self-timer sound and shutter sound used on this camera. These are called My Camera settings. You can also customize the **[M]** and **[S]** options for each item with images recorded on the memory card and newly recorded sounds or by using the supplied software. See the *Software Starter Guide* for details.

Item/Menu Screen	Setting Content	Reference Page
 <b>Theme</b>	Selects a common theme for the start-up image, start-up sound, operation sound, self-timer sound and shutter sound.* <sup>1</sup>	117
 <b>Start-up Image</b>	Sets the start-up image when you turn on the camera.	
 <b>Start-up Sound</b>	Sets the start-up sound when you turn on the camera.* <sup>1</sup>	
 <b>Operation Sound</b>	Sets the sound when any button other than the shutter button is operated.* <sup>1</sup>	
 <b>Selftimer Sound</b>	Sets the sound played 2 seconds before the shutter releases in self-timer mode.* <sup>1</sup>	
 <b>Shutter Sound</b>	Sets the shutter sound when you depress the shutter button. There is no shutter sound in Movie mode.* <sup>1</sup>	
<b>My Camera menu settings content</b>	<b>[M]</b> (Off) / <b>[1]</b> * <sup>2</sup> / <b>[2]</b> / <b>[3]</b>	

\*<sup>1</sup> How the [Mute] setting in the **[M] (Set up)** menu and each sound setting in the **[M] (My Camera)** menu are related

To turn off the start-up sound, operation sound, self-timer sound and shutter sound all at once, set [Mute] in the **[M] (Set up)** menu to [On]. When [Mute] is set to [On], each sound option will not play even if they are set individually to [On]. Note that the warning signal beeps even when the [Mute] setting is [On].

\*<sup>2</sup> Default setting

## Resetting the Settings to Default

You can reset the menu and button operation settings to default.

### 1 Turn the power on.

- Can be performed from Shooting or Playback mode.

### 2 Press the MENU button for longer than 5 seconds.

- The message “Reset settings to default?” appears on the LCD monitor.

### 3 Press the ← or → button to select [OK], and press the SET button.

- The screen on the right appears while resetting. The normal screen resumes when resetting is complete.
- To cancel resetting, select [Cancel] instead of [OK].

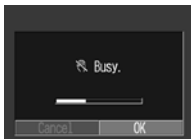

- The following settings do not reset to default.
  - [Date/Time], [Language] and [Video System] in the [ ] (Set up) menu (p. 72, 73)
  - The custom white balance (p. 85)
  - Newly registered My Camera settings (p. 117)
- When the camera is connected to a computer or a printer, this operation does not work.

## Using the Mode Dial (Creative Zone)

**Mode Dial** P Tv Av M

You can freely select camera settings such as the shutter speed and aperture value to suit your shooting purposes.

After settings are made, shooting procedures are the same as for the **AUTO** mode (p. 33).

See *Functions Available in Each Shooting Mode* (p. 159) at the end of this manual to find out which settings can be changed in which shooting modes.

### How to Use the Mode Dial

- 1** Check that the camera is in Shooting mode.
- 2** Turn the shooting mode dial and set the icon of the function you wish to use to .

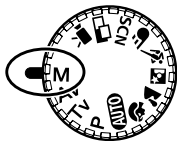

- If the LCD monitor is on, the shutter speed and aperture value appear automatically.



- The camera operates in the following ways according to the selected function:

Shutter  
Speed

Aperture  
Value

<b>P</b>	The camera automatically sets the shutter speed and aperture value.
<b>Tv</b>	The user selects a shutter speed using the <b>←</b> or <b>→</b> button.
<b>Av</b>	The user selects an aperture value using the <b>←</b> or <b>→</b> button.
<b>M</b>	The user selects the setting (the shutter speed or the aperture value) using the <b>SET</b> button and select a shutter speed or an aperture value using the <b>←</b> or <b>→</b> button.

- When the shutter button is pressed halfway, the shutter speed and aperture value appear on the LCD monitor. The correct exposure has been set when they appear in white.

### **3** Shoot the image.

## P Program AE

Use the program AE mode to have the camera automatically set the shutter speed and aperture value to match the brightness of the scene.

- The shutter speed and aperture value will show in red on the LCD monitor when the correct exposure cannot be obtained. Use the following methods to obtain the correct exposure and make them appear in white.
  - Use the flash
  - Change the ISO speed setting
  - Change the metering mode

### Differences between the P and **AUTO** Modes.

- The following settings can be adjusted in P mode, but not in **AUTO** mode.
 

• Exposure Compensation	• White Balance
• ISO Speed	• Flash (Flash on)
• AF frame selection	• Photo Effects
• Continuous Shooting	• Metering Mode
• Manual Focus	
- For the correlation between aperture value and shutter speed, see page 78.

## Tv Setting the Shutter Speed

When you set the shutter speed in the shutter-speed priority AE mode, the camera automatically selects an aperture value to match the brightness. Faster shutter speeds allow you to catch an instantaneous image of a moving subject while slower speeds create a flowing effect and allow you to shoot without a flash in dark areas.



- If the aperture value shows in red, the image is underexposed (insufficient light) or overexposed (too much light). Adjust the shutter speed using the ◀ or ▶ button until the aperture value display turns to white.
- The nature of CCD image sensors is such that noise in the recorded image increases at slow shutter speeds. This camera, however, applies special processing to images shot at shutter speeds slower than 1.3 seconds to eliminate the noise, thereby producing high-quality images. Nevertheless, a certain amount of processing time may be required before the next image can be shot.



- Please note that camera shake becomes a factor at slow shutter speeds. If the camera shake warning  appears on the LCD monitor, secure the camera to a tripod before shooting.
- The aperture value and shutter speed change according to the zoom state as follows.

	Aperture Value	Shutter Speed (seconds)
<b>Wide Angle</b>	F2.6 – 3.5	15 to 1/1250
	F4.0 – 8.0	15 to 1/2000
<b>Telephoto</b>	F5.5 – 7.1	15 to 1/1250
	F8.0	15 to 1/2000

- The fastest shutter speed for flash synchronization is 1/500 second. The camera automatically resets the shutter speed to 1/500 second if a faster speed is selected.

### Shutter Speed Display

The numbers in the table below indicate the shutter speed in seconds. 1/160 indicates 1/160 second. Also, quote marks indicate the decimal place, so that 0"3 indicates 0.3 second and 2" indicates 2 seconds.

15"	13"	10"	8"	6"	5"	4"	3"2	2"5	2"	1"6	1"3
1"	0"8	0"6	0"5	0"4	0"3						
1/4	1/5	1/6	1/8	1/10	1/13	1/15	1/20	1/25	1/30		
1/40	1/50	1/60	1/80	1/100	1/125	1/160	1/200				
1/250	1/320	1/400	1/500	1/640	1/800	1/1000					
1/1250	1/1600	1/2000									



## Av Setting the Aperture

The aperture adjusts the amount of light that passes through the lens. When you set the aperture in the aperture-priority AE mode, the camera automatically selects a shutter speed to match the brightness.

Selecting a lower aperture value (opening the aperture) allows you to fade the background and create a beautiful portrait. A higher aperture value (closing it) brings the entire range from foreground to background into focus. The larger the aperture value, the greater the range of the image brought into clear focus.



- If the shutter speed shows in red on the LCD monitor, the image is underexposed (insufficient light) or overexposed (too much light). Adjust the aperture value using the ◀ or ▶ button until the shutter speed display turns to white.
- Some aperture values may not be available with certain zoom positions (p. 78).



- Please note that camera shake becomes a factor with larger aperture values that slow down shutter speeds. If  (camera shake warning) appears on the LCD monitor, secure the camera to a tripod before shooting.
- In this mode, the shutter speed range with synchronized flash is 1/60 second to 1/500 second. The aperture value setting may therefore be changed automatically to match the synchronized flash speed even if its value was set previously.

### Aperture Value Display

The larger the aperture value, the smaller the lens aperture.

F2.6	F3.2	F3.5	F4.0	F4.5	F5.0	F5.5	F5.6
F6.3	F7.1	F8.0					



## M Manually Setting the Shutter Speed and Aperture

You can manually set the shutter speed and aperture to shoot images. You can select settings such as a long exposure to suit your purpose.

- When you press the shutter button halfway, the difference between the standard exposure\* and the selected exposure appears on the LCD monitor. If the difference is more than  $\pm 2$  stops, “-2” or “+2” appears in red.

\* The standard exposure is calculated by the AE function according to the selected metering method.



- See page 159 for settings that can be changed in this mode.
- If you wish to change the exposure, select the shutter speed or the aperture with the **SET** button and change the value using the **←** or **→** button.
- If the zoom is adjusted after these values are set, the aperture value may change in accordance with the zoom position.
- The LCD monitor's brightness matches the selected shutter speed and aperture value. When you select a fast shutter speed or shoot a subject in a dark place, the image will always be bright if the flash is set to  (Flash On, with Red-eye Reduction) or  (Flash On).
- For the correlation between aperture value and shutter speed, see page 78.

## Switching between Focusing Modes

**Mode Dial** P Tv Av M      SCN

You can change the autofocus frame (AF frame) selection method. The AF frame will appear when the LCD monitor is turned on (p. 24).

<input type="checkbox"/> <input type="checkbox"/> <input type="checkbox"/> <input type="checkbox"/> <input type="checkbox"/> <input type="checkbox"/> <input type="checkbox"/> <input type="checkbox"/> <input type="checkbox"/>	<b>On (Auto Selection)</b>	The camera automatically selects between 9 AF frames to focus on according to the shooting conditions.
<input type="checkbox"/> <input type="checkbox"/> <input type="checkbox"/> <input type="checkbox"/> <input checked="" type="checkbox"/> <input type="checkbox"/> <input type="checkbox"/> <input type="checkbox"/> <input type="checkbox"/>	<b>Off (Center-point)</b>	Of 9 AF frames, the center one is selected to focus. This is convenient for making sure the focus is exactly where you want it.

indicates the AF frame which appears on the LCD monitor

### 1 In the [ (Rec.)] menu, select **AiAF (AiAF)**.

- See *Selecting Menus and Settings* (p. 66).

### 2 Select [On] or [Off] using the or button.

- After selecting an option, you can immediately shoot the image by pressing the shutter button.

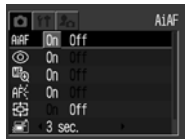



### 3 Press the MENU button.



- The AF frame is set to center-point when using the digital zoom.
- When [On] is selected, pressing the shutter button halfway will display the AF frames in the LCD monitor.

## Switching between Metering Modes

		Mode Dial P Tv Av M
	Evaluative	Appropriate for standard shooting conditions, including backlit scenes. The camera divides images into several zones for light metering. It evaluates the complex lighting conditions, such as the position of the subject, the brightness, the background, the direct light, and the backlighting, and adjusts the settings to the correct exposure for the main subject.
	Center-weighted Averaging	Averages the light metered from the entire frame, but gives greater weight to the subject matter at the center.
	Spot	Meters the area within the spot AE point frame at the center of the LCD monitor. Use this setting when you want to set the exposure on the subject in the center of the monitor.

### 1 Select \*(Evaluative) in the FUNC. menu.

- See *Selecting Menus and Settings* (p. 66).

\* The current setting is displayed.



### 2 Select a metering mode using the ← or → button.



### 3 Press the FUNC. button.

## Adjusting the Exposure

**Mode Dial** P Tv Av       SCN  

Adjust the exposure compensation setting to avoid making the subject too dark when it is backlit or shot against a bright background, or to avoid making lights appear too bright in night shots.

### 1 Select \*(+/- (Exp.)) in the FUNC. menu.

- See *Selecting Menus and Settings* (p. 66).

\* The current setting is displayed.

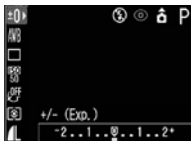



### 2 Adjust the compensation using the or button.

- The settings can be adjusted in 1/3 stops in the range of -2 stops to +2 stops.



- You can check the results of the compensation by viewing the image on the LCD monitor when it is on.
- You can shoot the image right after selecting settings by pressing the shutter button. The menu displays again after the shot, allowing you to change the settings easily.

### 3 Press the FUNC. button.

- To reset the exposure compensation, return the setting to 0 using the  or  button.







See *Photo Tips and Information* (p. 151).



## Adjusting the Tone (White Balance)

**Mode Dial** P Tv Av M       

When the white balance is set to match the light source, the camera reproduces colors more accurately.

Combinations of setting contents and light source are as follows.

	<b>Auto</b>	Settings are automatically set by the camera
	<b>Daylight</b>	For recording outdoors on a bright day
	<b>Cloudy</b>	For recording under overcast, shady or twilight skies
	<b>Tungsten</b>	For recording under tungsten and bulb-type 3-wavelength fluorescent lighting
	<b>Fluorescent</b>	For recording under warm-white, cool-white or warm-white (3-wavelength) fluorescent lighting

	<b>Fluorescent H</b>	For recording under daylight fluorescent, or daylight fluorescent-type 3-wavelength fluorescent lighting
	<b>Custom</b>	For recording with the optimal white balance data memorized in the camera from a white-colored object, such as white paper or cloth

### 1 Select \* (Auto) in the FUNC. menu.

- See *Selecting Menus and Settings* (p. 66).
- \* The current setting is displayed.

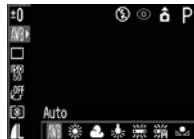

### 2 Select the white balance you wish to set using the or button.

- See *Setting a Custom White Balance* (p. 85).
- When the LCD monitor is on, you can check the setting on the display.
- A shot can be taken immediately by pressing the shutter button. The menu will reappear after the shot, allowing you to adjust the setting easily.

### 3 Press the FUNC. button.



The white balance cannot be adjusted when the photo effect is set to (Sepia) or (B/W) (p. 88).

## Setting a Custom White Balance

You can set a custom white balance to obtain the optimal setting for the shooting conditions by having the camera evaluate an object, such as a piece of white paper or cloth, or a photo-quality gray card that you wish to establish as the standard white color.

In particular, take a custom white balance reading for the following situations that are difficult for the (Auto) setting to detect correctly.

- Shooting close-ups (Macro mode)
- Shooting subjects of monotone color (such as sky, sea, or forest)
- Shooting with a peculiar source of light (such as a mercury-vapor lamp)

### 1 Select \* (Auto) in the FUNC. menu.

- See *Selecting Menus and Settings* (p. 66).
- \* The current setting is displayed.

### 2 Select (Custom) using the **←** or **→** button.





### 3 Aim the camera at a piece of white paper or cloth, or gray card and press the SET button.



- Aim the camera so that the white paper or cloth, or gray card, completely fills the frame at the center of the LCD monitor or completely fills the viewfinder.
- You can shoot right after setting the white balance by pressing the shutter button. The menu displays again after the shot, allowing you to change the settings easily.

### 4 Press the FUNC. button.



- You are recommended to set the white balance when shooting in the following conditions.
  - **The shooting mode dial is set to P and the exposure compensation is set to  $\pm 0$ .**  
The correct white balance may not be obtained when the exposure is incorrect (image is completely black or white).
  - **The zoom is positioned to the telephoto end setting.**  
Set the digital zoom to [Off].
  - **The flash is set to  (Flash On) or  (Flash Off).**  
Use the same flash setting as the one that will be used for shooting when you set the white balance. If the white balance setting conditions and shooting conditions are not the same, the correct white balance may not be obtained.  
When the flash is set to   (Auto with red-eye reduction) or  (Auto), the flash may fire while the white balance data is recorded to the custom white balance. If this happens, make sure the flash also fires when you shoot the image.
  - **The ISO speed is set to the same setting to shoot the image.**

- In  mode, white balance data cannot be read. Use a different shooting mode to read the white balance data beforehand.
- The custom white balance setting is not cancelled even if settings are reset to default settings (p. 75).



## Changing the ISO Speed

Mode Dial P Tv Av M

By raising the ISO speed, you can shoot bright images even in poor lighting conditions. This function is convenient when you want to prevent camera shake, shoot without the flash or shoot with a faster shutter speed in dark conditions.

### 1 Select \*(ISO Speed) in the FUNC. menu.

- See *Selecting Menus and Settings* (p. 66).

\* The current setting is displayed.



### 2 Select the ISO speed using the ← or → button.

- A shot can be taken immediately by pressing the shutter button. The menu will reappear after the shot, allowing you to adjust the settings easily.

### 3 Press the FUNC. button.



- Higher ISO speeds increase the image noise. To take clean images, use as low an ISO speed as possible.
- The [AUTO] setting selects the optimal speed. It will automatically raise the speed when the light from the flash is insufficient to illuminate the subject matter.









- You can easily shoot images in dark places such as indoor settings by using the  (Indoor (p. 52)) option of the **SCN** mode.
- See *Photo Tips and Information* (p. 152).

## Changing the Photo Effect

Mode Dial P Tv Av M      

You can shoot with different saturation and contrast color effects.

	<b>Effect Off</b>	Records normally with this setting.
	<b>Vivid</b>	Emphasizes the contrast and color saturation to record in bold color.
	<b>Neutral</b>	Tones down the contrast and color saturation to record neutral hues.
	<b>Low Sharpening</b>	Records subjects with softened outlines.
	<b>Sepia</b>	Records in sepia tones.
	<b>B/W</b>	Records in black and white.

### 1 Select \* (Effect Off) in the FUNC. menu.

- See *Selecting Menus and Settings* (p. 66).

\* The current setting is displayed.

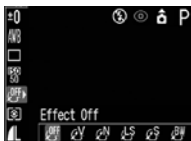

### 2 Select the photo effect using the or button.

- If the LCD monitor is on, you can check the photo effect by viewing the image on the LCD monitor.
- A shot can be taken immediately by pressing the shutter button. The menu will reappear after the shot, allowing you to adjust the settings easily.

### 3 Press the FUNC. button.

## Adjusting the Flash Output

Mode Dial **M**

In **M** mode, the flash output can be controlled in three steps when shooting.

### 1 Select (Flash Output) in the FUNC. menu.

- See *Selecting Menus and Settings* (p. 66).



### 2 Adjust the flash output using the or button.

- A shot can be taken immediately by pressing the shutter button. The menu will reappear after the shot, allowing you to adjust the settings easily.

### 3 Press the FUNC. button.



When the flash output is low, less shadow appears in the image. However, when shooting a wide scene or area, the image will likely be darker due to insufficient light. When adjusting the flash output, consider all the shooting conditions, including the distance to the subject.

## Shooting Hard-to-Focus Subjects

**Mode Dial** AUTO P Tv Av M     SCN  

The autofocus may not work well on the following types of subjects.

- Subjects with extremely low contrast to the surroundings
- Subjects mixing close and far objects
- Subjects with extremely bright objects at the center of the composition
- Subjects that are moving quickly
- When shooting through glass, get as close as possible to avoid reflection off the glass.
- Subject with horizontal stripes

To shoot these subjects, first aim the camera at an object at a similar distance, lock the focus and recompose the image with the desired subject, or use manual focus.

## Shooting with Focus Lock

- 1 Aim the AF frame at an object at a similar distance to the subject you wish to shoot.**
- 2 Press the shutter button halfway to lock the focus.**
  - The AE setting will also lock when you do this. The exposure may occasionally be incorrect if the difference between the two items is too great. Use AF Lock when this happens.
- 3 Recompose the image and press the shutter button all the way to shoot the image.**

## Shooting with AF Lock

- 1 Press the shutter button halfway to lock the focus. Keep it pressed and press the MF button.**
  - The **MF** icon appears on the LCD monitor.

- The focus will stay locked even if the shutter button and the **MF** button are released.
- Pressing the **MF** button again cancels the AF lock setting.

## 2 Recompose the image and press the shutter button all the way to shoot the image.



AF lock is not available in **AUTO** and  modes.



- When shooting with focus lock, you can lock the focus to the subject in the center AF frame by setting **AF-AREA** to [Off] in the [ (Rec.)] menu beforehand.
- Shooting with AF Lock is convenient because you can let go of the shutter button to recompose the image. Moreover, the focus stays locked after the shot is taken, so the same focus is used in subsequent shots.

## Shooting in Manual Focus Mode



The focus can be manually set.

### 1 Press the **MF** button until **MF** appears.

- The **MF** indicator appears.
- When the [ (Rec.)] menu's [MF-Point Zoom] is set to [On], the portion of the image in that frame will appear magnified.\*



**MF** Indicator

- \* Except in the  (Stitch Assist) or  (Movie) modes, when the digital zoom is activated or a TV is used as the display.
- \* Can also be set so that the image displayed is not magnified (p. 69).
- The **MF** indicator shows approximate figures. Use them as a shooting guideline only.
- In the **Tv**, **Av**, or **M** modes, pressing the **SET** button cycles the selection between the shutter speed, the aperture value, and the **MF** indicator. (A green  appears next to the selected item).

## 2 Focus using the ◀ or ▶ button and shoot the image.

- Adjust the focus using the ◀ or ▶ button until the image appears focused on the LCD monitor.
- Pressing the **MF** button again cancels the manual focus mode.



- You can use manual focus in the macro focal distance 5 to 45 cm (2.0 in. to 1.5 ft.) at wide angle end and 30 to 45 cm (11.8 in. to 1.5 ft.) at telephoto end. In this case, the scale of the MF indicator will be changed.
- You can change the MF indicator displayed distance units (p. 72).

## Setting the Auto Rotate Function

This camera is equipped with an Intelligent Orientation sensor that detects the orientation of an image shot with the camera held vertically and automatically rotates it to the correct viewing orientation in the display. You can set this function on/off.



### 1 In the [M] (Set up) menu, select (Auto Rotate).

- See *Selecting Menus and Settings* (p. 66).



### 2 Select [On] and press the MENU button.

- When this function is [On], an icon showing the orientation of the camera appears at the upper right corner of the LCD monitor (when information display is on).

	Normal
	Right end down
	Left end down



- This function may not operate correctly when the camera is pointed straight up or down. Check that the arrow  is pointing in the right direction and if it is not, then set the Auto Rotate function to [Off].
- Even if the Auto Rotate function is set to [On], the orientation of images downloaded to a computer will depend upon the software used to download the images.



When the camera is held vertically to shoot, the Intelligent Orientation sensor judges the upper end to be “up” and the lower end to be “down”. It then regulates the optimal white balance and exposure for vertical photography. This function operates regardless of the on/off status of the Auto Rotate function.

## Rotating Images in the Display

You can rotate an image by 90° or 270° clockwise in the LCD monitor.





(Original)





90°



270°

**1** In the [ (Play)] menu, select  (Rotate) and press the SET button.

- See *Selecting Menus and Settings* (p. 66).

**2** Press the  or  button to select the image to be rotated and press the SET button.

- The image cycles to the next orientation (90° → 270° → original) each time the SET button is pressed.

**3** Press the MENU button.

- The display will return to the Play menu. Pressing the **MENU** button again returns to the playback screen.



- Movies cannot be rotated.
- When images are downloaded to a computer, the orientation of images rotated by the camera will depend upon the software used to download the images.



- Rotated images can be magnified (p. 59).
- Images taken vertically with the auto rotate function (p. 92) set to [On] will automatically be rotated to the vertical position when viewed on the LCD monitor.



## Attaching Sound Memos to Image

In Playback mode (including single image playback and index playback), you can attach sound memos (up to 60 seconds) to an image. The sound data is saved in WAVE format.

### 1 Select (Sound Memo) in the [ (Play)] menu and press the SET button.

- See *Selecting Menus and Settings* (p. 66).
-  icon appears.

### 2 Select the image to which you wish to attach the sound memo using the or button, and press the SET button.

- The Sound Memo panel appears.







Sound Memo Panel

### 3 Select (Record) using the or button and press the SET button

- Recording starts and the elapsed recording time and remaining recording time is displayed.
- To stop recording, press the SET button. To resume recording, press the SET button again.
- Up to 60 seconds of recordings may be added to any one image.

#### Playing the Sound Memos

- Select  (Play) in step 3. The  icon is displayed on images with sound memos.
- To stop playback, press the SET button. To resume playback, press the SET button again. You can adjust the volume using the  or  button.

#### Erasing the Sound Memos

- Select  (Erase) in step 3.

#### Exiting the Sound Memos Settings

- Select  (Exit) in step 3.



- You cannot attach sound memos to movies.
- When the memory card capacity is full, a “Memory card full” message appears and recording will not be possible to that card.
- You cannot record or play back sound memos for images that already have an incompatible sound memo attached. If you attempt to record or play such images the “Incompatible WAVE format” message will display. Incompatible sound data can be deleted with this camera.
- Sound memos for protected images cannot be erased (p. 97).



- You can also adjust the volume of the sound memo in the Set up menu (p. 71).
- If you set [Mute] to [On] in the Set up menu (p. 70), no sound is reproduced. However, you can resume the sound and adjust the volume during sound playback by using the  $\blacktriangle$  or  $\blacktriangledown$  button.

## Auto Play

Use this feature to automatically play back all of the images in the memory card (Auto Play). The LCD monitor displays each image for approximately 3 seconds.

### 1 In the [ (Play)] menu, select (Auto Play) and press the SET button.

- See *Selecting Menus and Settings* (p. 66).
- Once you have selected it, Auto Play starts.
- As with the single image playback mode, using the  $\blacktriangleleft$  or  $\blacktriangleright$  button during auto play will advance through the images more rapidly.

### Pausing and Resuming Auto Play

- You can pause Auto Play at any time by pressing the SET button. You can then resume it by pressing the SET button again.

### Stopping Auto Play

- To stop Auto Play, press the MENU button.



- The display interval may vary for some images.
- Movies play for the length of time that they were recorded.
- The power saving function is disabled during Auto Play (p. 96).

## Protecting Images

Use the protect feature to protect important images and movies from accidental erasure.

**1** In the [ (Play)] menu, select (Protect) and press the **SET** button.

- See *Selecting Menus and Settings* (p. 66).

**2** Select an image you want to protect using the **←** or **→** button and press the **SET** button.

- The icon appears on protected images.



Protected Icon

- To release the protection, press the **SET** button again.
- You can make the selection of images easier by toggling between single image playback and index playback by pressing the zoom lever (p. 58, 60).

### **3** Press the **MENU** button.

- The display will return to the Play menu. Pressing the **MENU** button again returns to the playback screen.



Please note that formatting (initializing) a memory card (p. 19) erases all data, including protected images. Please check the contents of a memory card before formatting it.

## About Printing

---

Images shot with this camera can be printed using one of the following methods.

- You can easily print images stored in the memory card by connecting the camera to a direct print compatible printer\*<sup>1</sup> with a cable and then pressing the camera's  button.
- You can select images and specify the number of print copies (DPOF\*<sup>2</sup> Print Settings) with the camera before sending the image (memory card) to a photo developing service.

\*<sup>1</sup> As this camera complies with the industry standard *PictBridge*, you can print images using Canon Compact Photo printers (SELPHY CP series), Card Photo printers, Bubble Jet Printers (PIXMA series/SELPHY DS series), in addition to non-Canon *PictBridge* compliant printers.

\*<sup>2</sup> Digital Print Order Format

This manual explains the DPOF print settings. For information on how to print images, refer to the *Direct Print User Guide* supplied with the camera. Also, refer to your printer's manual.

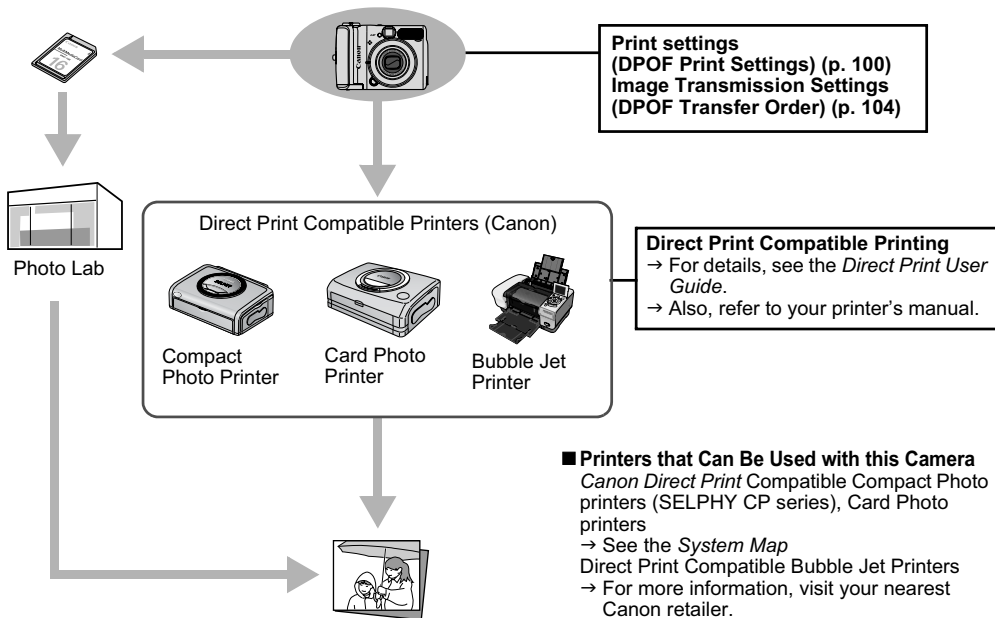

## DPOF Print Settings



You can select images on a memory card for printing and specify the number of print copies in advance using the camera. This is extremely convenient for sending the images to a photo developing service that supports DPOF, or for printing on a direct print compatible printer.

Refer to the *Direct Print User Guide* for instructions on how to print.







- The  icon may appear on images that have had print settings set by another DPOF compliant camera. These settings will be overwritten by those set by your camera.
- The output of some printers or photo developing services may not reflect the specified print settings.
- Print settings cannot be set for movies.

## Selecting Images Singly

**1** In the [ (Play)] menu, select  (Print Order) and press the SET button.

- See *Selecting Menus and Settings* (p. 66).

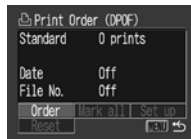

**2** Select [Order] using the , ,  or  button and press the SET button.



- Selecting [Reset] will cancel all print settings for the images.

**3** Select images for printing.

- As shown below, selection methods differ depending on the selected  (Print Type) setting (p. 103).

 (Standard)/  (Both)

Single image playback

- Select an image using the **←** or **→** button and specify the number of copies (up to 99) to be printed using the **↑** or **↓** button.

Number of Copies



### Index playback (p. 60)

- Select an image using the **↑**, **↓**, **←**, or **→** button and press the **SET** button to determine the selection. Use the **↑** or **↓** button to specify the number of copies (up to 99) to be printed.

### [Index]

#### Single image playback

- Select an image using the **←** or **→** button and press the **SET** button to select or deselect it. A checkmark displays on selected images.

Index print selection



### Index playback (p. 60)

- Select an image using the **↑**, **↓**, **←**, or **→** button and press the **SET** button to select or deselect it. A checkmark displays on selected images.

## 4 Press the MENU button.

- Returns to the Print Order menu. Pressing the **MENU** button again returns to the Play menu. Press it again to go back to the Playback screen.

### Selecting All Images on the Memory Card at a Time

- 1 In the [**Play**] menu, select [**Print Order**] and press the **SET** button.

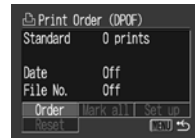

- See *Selecting Menus and Settings* (p. 66).

**2** Select [Mark all] using the **↑**, **↓**, **←** or **→** button and press the **SET** button.

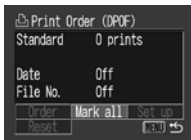

**3** Select [OK] using the **←** or **→** button and press the **SET** button.

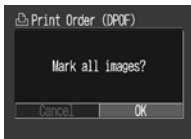

- The display will return to the Print Order menu.

**4** Press the **MENU** button.

- The display returns to the Play menu. Press the **MENU** button again to go back to the Playback screen.





- Images are printed in order from oldest to newest by the shooting date.
- A maximum of 998 images can be set.
- When [Print Type] is set to [Both], the number of copies can be set. When it is set to [Index], the number of copies cannot be set (only one copy will be printed).
- Print settings can also be assigned to images with the bundled software programs (ZoomBrowser EX or ImageBrowser) on a computer.
- Do not set the date in the DPOF print settings when printing images that have had the date embedded with the [Date Stamp] function. This may cause the date to be printed twice.



## Setting the Print Style

Set the print style after selecting the image to print. The following print settings can be selected.

 <b>Print Type</b>	<input checked="" type="checkbox"/> <b>Standard</b>	Prints one image per page.
	<input type="checkbox"/> <b>Index</b>	Prints the selected images together at a reduced size in an index format.
	<input checked="" type="checkbox"/> <input type="checkbox"/> <b>Both</b>	Prints the images in both the standard and index formats.
<input checked="" type="checkbox"/> <b>Date</b>	Adds the date to the print.	
<input checked="" type="checkbox"/> <b>File No.</b>	Adds the file number to the print.	

- In the [] (Play) menu, select  (Print Order) and press the SET button.



- See *Selecting Menus and Settings* (p. 66).

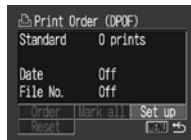

- Select [Set up] using the  $\uparrow$ ,  $\downarrow$ ,  $\leftarrow$  or  $\rightarrow$  button and press the SET button.



- Selecting [Reset] will cancel all print settings for the images.

- Select  (Print Type),  (Date) or  (File No.) using the  $\uparrow$  or  $\downarrow$  button, then select a setting using the  $\leftarrow$  or  $\rightarrow$  button.

### **Print Type**

Select [Standard], [Index] or [Both].



### **Date**

Select [On] or [Off].



### **File No.**

Select [On] or [Off].

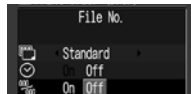

## 4 Press the MENU button.

- Returns to the Print Order menu. Pressing the **MENU** button again returns to the Play menu. Press it again to go back to the Playback screen.



- When [Print Type] is set to [Index], the [Date] and [File No.] cannot be set to [On] at the same time.
- Both [Date] and [File No.] can be set to [On] if [Print Type] is set to [Both] or [Standard]. However, the data that can be printed may vary depending on the type of printer you are using.
- Embedded dates in  (Postcard Print mode (p. 54)) print out even when [Date] is set to [Off].



The date prints in the format specified in the Date/Time menu (p. 22).

## Image Transmission Settings (DPOF Transfer Order)

You can use the camera to specify settings for images before downloading to a computer. Refer to the *Software Starter Guide* for instructions on how to transfer images to your computer.

The settings used on the camera comply with the Digital Print Order Format (DPOF) standards.





The  icon may appear on images that have had transfer settings set by another DPOF compliant camera. These settings will be overwritten by those set by your camera.

## Selecting Images for Transferring



There are two ways to select images.

- Select the images singly
- Select all the images on a memory card

**Selecting Images Singly**



**1** In the [ (Play)] menu, select  (Transfer Order) and press the SET button.

- See *Selecting Menus and Settings* (p. 66).

**2** Select [Order] using the  or  button and press the SET button.

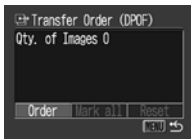
- Selecting [Reset] will cancel all transfer order settings.



**3** Select an image using the  or  button and press the SET button to select and deselect them.

- A checkmark displays on selected images.





- You can switch to index playback (9 image display) by pressing the zoom lever toward  and select images using the same procedures.

**4** Press the MENU button.



- Returns to the Transfer Order menu. Pressing the MENU button again returns to the Play menu. Press it again to go back to the Playback screen.

**Selecting All Images on the Memory Card at a Time**

**1** In the [ (Play)] menu, select  (Transfer Order) and press the SET button.

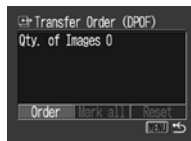
- See *Selecting Menus and Settings* (p. 66).



**2** Select [Mark all] using the  or  button and press the SET button.

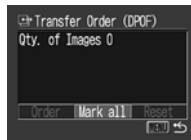

### 3 Select [OK] using the ← or → button and press the SET button.

- The display returns to the Transfer Order menu.

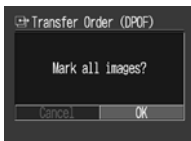

### 4 Press the MENU button.

- The display returns to the Play menu. Pressing the MENU button again returns to the playback screen.



- Images are transferred in order from oldest to newest by the shooting date.
- A maximum of 998 images can be selected.

## Downloading Images to a Computer

The following methods can be used to download images recorded by the camera to a computer. Some methods are not applicable to some operating systems. See *Computer System Requirements* (p. 107) in advance.

### • Downloading via a Camera to Computer Connection



- With this method, you download images using computer commands after you have installed the appropriate software.
  - ➔ See *Connecting the Camera to a Computer* (p. 107) and the separate *Software Starter Guide*.

Windows 98 SE   Windows Me   Windows 2000   Windows XP

- With this method, you download images using camera button operations after you have installed the appropriate software (the computer settings only need to be adjusted for the first download).

➔ See *Connecting the Camera to a Computer* (p. 107) and *Downloading Images by Direct Transfer* (p. 111).

Windows XP   Mac OS X

- With this method, you download images using computer commands without installing any software.

➔ See *Connecting the Camera to a Computer* (p. 107) (software installation is not required) and *Connecting the Camera to the Computer to Download Images without Installing the Software* (p. 113).

### ● Downloading from a Memory Card

➔ See *Downloading from a Memory Card* (p. 113).

## Connecting the Camera to a Computer

### Computer System Requirements

#### ● Windows

OS	Windows 98 Second Edition (SE) Windows ME Windows 2000 Service Pack 4 Windows XP (Including Service Pack 1 and Service Pack 2)
Computer Model	The above OS should be pre-installed on computers with built-in USB ports.
CPU	Pentium 500 MHz or higher processor
RAM	Windows 98 SE/Windows Me: 128 MB or more Windows 2000/Windows XP: 256 MB or more
Interface	USB
Free Hard Disk Space	<ul style="list-style-type: none"> <li>● <b>Canon Utilities</b> ZoomBrowser EX: 250 MB or more (including the PhotoRecord printing program) PhotoStitch: 40 MB or more</li> <li>● <b>Canon Camera TWAIN Driver:</b> 25 MB or more</li> <li>● <b>Canon Camera WIA Driver:</b> 25 MB or more</li> <li>● <b>ArcSoft PhotoStudio:</b> 50 MB or more</li> </ul>
Display	1,024 x 768 pixels/High Color (16 bit) or better

## ● Macintosh

OS	Mac OS X (v10.1.5 – v10.3)
Computer Model	The above OS should be pre-installed on computers with built-in USB ports.
CPU	PowerPC G3/G4/G5
RAM	256 MB or more
Interface	USB
Free Hard Disk Space	<ul style="list-style-type: none"> <li>● <b>Canon Utilities</b> ImageBrowser: 200 MB or more PhotoStitch: 40 MB or more</li> <li>● <b>ArcSoft PhotoStudio</b>: 50 MB or more</li> </ul>
Display	1,024 x 768 pixels/32,000 Colors or better

### IMPORTANT

You must install the software and driver bundled on the supplied Canon Digital Camera Solution Disk onto your computer before connecting the camera to a computer.



The camera will not operate correctly if you connect it to your computer before installing the driver and software. If this happens, please refer to the *Troubleshooting* section of the *Software Starter Guide*.



- You do not need to turn off the camera or computer power when making a USB connection.
- Please refer to your computer's manual for information regarding the location of the USB port.
- You are recommended to use new AA size batteries, fully charged AA size NiMH batteries (sold separately) or AC Adapter Kit ACK800 (sold separately) to power the camera when connecting to a computer (p. 129, 131).
- All procedures performed with a connection to a USB 2.0 compliant board are not guaranteed.

# 1 Install the driver and the software applications bundled on the Canon Digital Camera Solution Disk (first time only).

- Please see the *Software Starter Guide* for the installation procedures.
- With a Macintosh, it is next necessary to set the ImageBrowser auto start settings. Please see the *Software Starter Guide* for details.

# 2 Use the supplied interface cable to connect the computer's USB port to the camera's DIGITAL terminal.

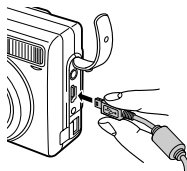
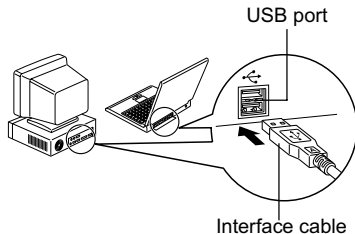

## DIGITAL Terminal

1. Open the terminal cover with your finger nail.
2. Hold the USB connector with the ← side facing the front of the camera and insert it into the **DIGITAL** terminal securely.

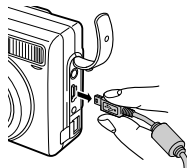

Always grasp the connector's sides to remove the interface cable from the camera's **DIGITAL** terminal.

# 3 Slide the camera's mode switch to .

# 4 Press the Power button until the power lamp lights green.

## Windows

→ Proceed to step 5.

## Macintosh

→ Refer to the *Software Starter Guide* and download images.

**5** Select [Canon CameraWindow] in the event dialog that appears on the computer and click [OK] (first time only).



If the events dialog fails to appear, click the [Start] menu, followed by [Programs] or [All Programs], [Canon Utilities], [CameraWindow], and [CameraWindow].

- The following window appears.





**Using the software and computer to download images:**

→ See the *Software Starter Guide*.



**Using the Camera to Download Images (Direct Transfer Function):**



→ See *Downloading Images by Direct Transfer* (p. 111).

**Downloading Images by Direct Transfer**

Use this method to download images using camera operations.

Install the supplied software and adjust the computer settings before using this method for the first time (p. 109).



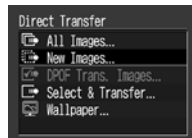

	<b>All Images</b>	Transfers and saves all images to the computer.
	<b>New Images</b>	Transfers and saves to the computer only the images that have not been previously transferred.

	<b>DPOF Trans. Images</b>	Transfers and saves to the computer only the images with DPOF Transfer Order settings (p. 104).
	<b>Select &amp; Transfer</b>	Transfers and saves single images to the computer as you view and select them.
	<b>Wallpaper</b>	Transfers and saves single images to the computer as you view and select them. The transferred images display on the computer desktop.

**1 Confirm that the Direct Transfer menu is displayed on the camera's LCD monitor.**

- The  button will light blue. Direct Transfer Menu
- Press the **MENU** button if the Direct Transfer menu fails to appear.

### All Images/New Images/DPOF Trans. Images

**2** Use the **↑** or **↓** button to select ,  or  and press the  button.

- The images will download. During downloading, the  button blinks blue. When downloading is complete, the display will return to the Direct Transfer menu.
- To cancel the transfer, press the **SET** button.

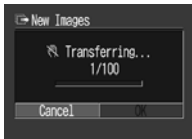

### Select & Transfer/Wallpaper

**2** Use the **↑** or **↓** button to select  or  and press the  button (or **SET** button).

**3** Use the **←** or **→** button to select images to download and press the  button (or **SET** button).

- The images will download.

- The  button will blink blue while downloading is in progress.

**4** Press the **MENU** button.

- The display will return to the Direct Transfer menu.



Only JPEG images can be downloaded as wallpaper for the computer. After images are transferred, they are automatically converted to BMP images.



The option selected with the  button is retained even when the camera's power is turned off. The previous setting will be in effect the next time the Direct Transfer menu is displayed. The image selection screen will appear directly when the [Select & Transfer] or the [Wallpaper] option was last selected.

## Connecting the Camera to the Computer to Download Images without Installing the Software

If you are using Windows XP or Mac OS X (v10.1.5 – v10.3), you can use the software distributed with these operating systems to download images without installing the software bundled on the Canon Digital Camera Solution Disk. This is useful for downloading images to a computer in which the software is not installed.

However, please note that there are certain limitations to downloading images with this method. For more details, please refer to the supplied leaflet entitled *For Windows® XP and Mac OS X Users*.

### **1 Use the supplied interface cable to connect the computer's USB port to the camera's DIGITAL terminal.**

- See steps 2 to 4 on page 109.

### **2 Follow the onscreen instructions to proceed with downloading.**

## Downloading from a Memory Card

### **1 Eject the memory card from the camera and insert it into a memory card reader connected to the computer.**

- Refer to your card adapter's or card reader's manual for information regarding the connection between the computer and card adapter or card reader.

### **2 Double-click the icon of the drive containing the memory card.**

- Depending on the operating system, a window opens automatically.

### **3 Copy images from the card into a folder of your choice on the hard disk.**

- The images are stored in the [xxxCANON] folders located in the [DCIM] folder (where xxx is a three-digit number from 100 to 998 (p. 116)).

## Viewing Images on a TV Set

You can use a video-compatible television as a monitor to shoot or play back images when it is connected to the camera with the supplied AV Cable AVC-DC300.

- 1** Turn off the camera (p. 30) and the TV.
- 2** Attach the AV cable to the A/V Out terminal on the camera.

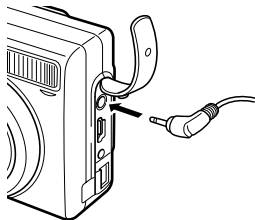

- 3** Plug the other ends of the AV cable to the VIDEO IN and AUDIO IN jacks on the TV.

Yellow Plug to the VIDEO IN Jack

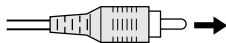

Black Plug to the AUDIO IN Jack

- 4** Turn on the TV and switch it to Video mode.
- 5** Turn on the camera (p. 30).
  - The image will appear on the TV. Shoot or playback images as usual.
  - If the images are not appearing on the TV when shooting, press the **DISP.** button.



- No image will appear on the LCD monitor when the camera is connected to a TV monitor.
- The video output signal can be switched (NTSC or PAL) to accommodate different regional standards (p. 73). The default setting varies between regions.
  - NTSC: Japan, U.S.A., Canada, Taiwan, etc.
  - PAL: Europe, Asia (excluding Taiwan), Oceania, etc.

If the video system is set incorrectly, the camera output may not display properly.
- If the TV is a stereo model, you can plug the audio plug into either the left or right Audio In jack. Please refer to the TV's manual for details.
- A TV set cannot be used in  mode.

## Resetting the File Number

The images you shoot are automatically assigned file numbers. You can select how the file number is assigned.

<b>On</b>	The file number is reset to the start (100-0001) each time a new memory card is inserted. New images recorded on memory cards with existing images are assigned the next available number.
<b>Off</b>	The file number of the last image to be shot is memorized so that images recorded to a new memory card start from the next number.

### 1 In the [Set up] menu, select **File No. Reset**.

- See *Selecting Menus and Settings* (p. 66).



### 2 Select [On] or [Off] using the **←** or **→** button.

### 3 Press the MENU button.



Setting the File Number Reset to [Off] is useful for avoiding file number duplication when images are downloaded to a computer.

#### About File and Folder Numbers

Images are assigned file number from 0001 to 9900, and folders are assigned folder numbers from 100 to 998 (Folder numbers cannot contain 99 in the last two digits).

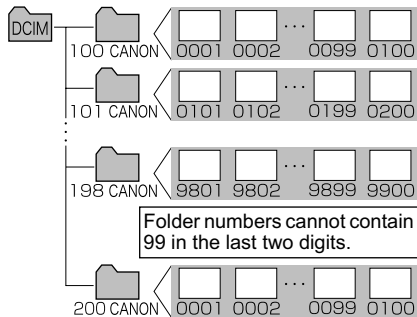

#### Folder File Capacity

Each folder usually contains up to 100 images. However, since images shot in continuous shooting and Stitch Assist mode are always saved into the same folder, a folder may contain more than 100 images. The number of images may also exceed 100 if a folder contains images copied from a computer or images shot with other cameras. Please note, however, that the images in folders containing 2001 or more images cannot be played back in this camera.

## Customizing the Camera (My Camera Settings)

My Camera allows you to customize the start-up image and start-up, operation, self-timer and shutter sounds. Each menu item has three choices.

**Example:** Start-up image



**1**

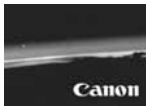

**2**



**3**

As default settings, My Camera setting **2** has a science fiction theme and My Camera setting **3** has an animal theme.

## Changing My Camera Settings

### 1 Press the MENU button.

- The [MENU] (Rec.) or [MENU] (Play) menu appears.



**2** Select the [MENU] (My Camera) menu pressing the **▶** button twice and select a menu item using the **▲** or **▼** button.

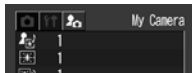

**3** Select the contents you wish to set using the **◀** or **▶** button.



**4** Press the MENU button.

- The menu closes and settings are activated.
- In Shooting mode, the menu can be closed by pressing the shutter button halfway.



- If you select [Theme] in step **2**, you can select a consistent theme for each of the My Camera settings.
- If [Mute] in the [MENU] (Set up) menu is set to [On], no sound is reproduced except for the warning signal regardless of the selected My Camera settings (p. 74). The Start-up image displays.

## Registering My Camera Settings

Images recorded onto the memory card and newly recorded sounds can be added to the camera as My Camera settings. You can also use the supplied software to upload your computer's images and sounds to the camera. The following menu items can be saved to the camera.

- Start-up Image
- Start-up Sound
- Operation Sound
- Self-timer Sound
- Shutter Sound



A computer is required to restore the My Camera Settings to the defaults. Use the supplied software (ZoomBrowser EX/ImageBrowser) to add the default settings to the camera.

## Registering the Memory Card Images and Sounds

### 1 Slide the mode switch to .

- The camera turns into Playback mode.

### 2 Press the MENU button.

- The [ (Play)] menu appears.



### 3 Select [ (My Camera)] menu using the button and select the menu item you wish to register using the or button.



### 4 Select or using the or button.

-   icon appears.





## 5 Press the DISP. button.

- An image appears.

### Registering [Start-up Image]

## 6 Select the image you wish to register using the ◀ or ▶ button.



## 7 Press the SET button.



### Registering [Start-up Sound], [Shutter Sound], [Operation Sound], and [Selftimer Sound]

## 6 Select (Record) using the ◀ or ▶ button and press the SET button.

- Recording starts.
- Recording stops when the time is exceeded (p. 120).



## 7 Select (Register Sound) using the ◀ or ▶ button and press the SET button.

- Select  (Exit) to return to the My Camera menu without registering.
- Select  (Play) to play the recorded sound.

## 8 Select [OK] using the ◀ or ▶ button and press the SET button.



- Sounds recorded with the movies and sound memo function cannot be added as My Camera settings (p. 56, 95).
- When you register new My Camera settings, the previously registered settings are erased.

## Data that can be Registered as My Camera Settings

My Camera settings should conform to the below data types. However, memory card images shot with this camera can be registered as My Camera settings regardless of the below data types. (excluding sounds recorded as a movie or with the sound memo function (p. 95))





### ● Start-up Image

- Compression Method JPEG (baseline JPEG)
- Sampling Rate 4:2:0 or 4:2:2
- Dimensions 320 x 240 pixels
- Data Size 20 KB or less

### ● Start-up, Operation, Self-timer and Shutter Sounds

- Compression Method WAVE (monaural)
- Quantization Bits 8 bit
- Sampling Frequency 11.025 kHz or 8.000 kHz

### • Recording Time

	11.025 kHz	8.000 kHz
 <b>Start-up Sound</b>	1.0 sec. or less	1.3 sec. or less
 <b>Operation Sound</b>	0.3 sec. or less	0.4 sec. or less
 <b>Self-timer Sound</b>	2.0 sec. or less	2.0 sec. or less
 <b>Shutter Sound</b>	0.3 sec. or less	0.4 sec. or less

Any data types other than those described above cannot be used with this camera.

An example of this function is to record “Say Cheese” as a self-timer sound so the camera will play back this sound 2 seconds before the photo is taken. You could also record cheerful music to bring out the natural smiles of your subjects, or so they can strike a pose fitting the music. In these ways, you can customize your camera by creating and adding new My Camera settings.

See the supplied *Software Starter Guide* for more information on creating and adding to the My Camera data.

# List of Messages

The following messages may appear on the LCD monitor.

● For messages which may appear when a printer is connected, refer to the *Direct Print User Guide*.

<b>Busy...</b>	The camera is recording image data to the memory card. The playback mode is running.
<b>No memory card</b>	You turned on the power without a memory card installed.
<b>Cannot record !</b>	You attempted to shoot with no memory card installed, or attempted to attach a sound memo to a movie.
<b>Memory card error</b>	Memory card has experienced an anomaly.
<b>Memory card full</b>	Memory card is too full to accommodate more images or print settings.
<b>Card locked !</b>	The SD card (sold separately) is write-protected.
<b>Naming error !</b>	The image could not be created because there is an image with the same name as the directory that the camera is attempting to create, or the highest possible file number has already been reached. In the [Set up] menu, please set [File No. Reset] to [On]. After you save all the images you wish to retain onto a computer, format the memory card (p. 19). Please note that formatting will erase all the existing images and other data.
<b>Change the batteries</b>	Battery charge is insufficient to operate the camera. Replace both batteries at the same time with new AA-size alkaline batteries (p. 15) or fully recharged Canon NiMH batteries.
<b>No image</b>	No images recorded on memory card.
<b>Image too large</b>	You attempted to play back an image larger than 4064 x 3048 pixels or with a large data size.
<b>Incompatible JPEG format</b>	You attempted to play back an incompatible JPEG image.
<b>Corrupted data</b>	You attempted to play back an image with corrupted data.

<b>RAW</b>	You attempted to play back a RAW image.
<b>Unidentified Image</b>	You attempted to play back an image that was recorded in a special data type (proprietary data type used by the camera of another manufacturer, etc.) or a movie recorded by another camera.
<b>Cannot magnify !</b>	You attempted to magnify an image recorded in a different camera or data type, an image edited with a computer, or a movie.
<b>Cannot rotate</b>	You attempted to rotate an image recorded in a different camera or data type, an image edited with a computer, or a movie.
<b>Incompatible WAVE format</b>	A sound memo cannot be added to this image since the data type of the existing sound memo is incorrect.
<b>Cannot register this image !</b>	You attempted to register an image recorded in a different camera or a movie as a start-up image.
<b>Protected !</b>	You attempted to erase a protected image or movie.
<b>Too many marks</b>	Too many images have been marked for printing or transferring. Cannot process any more.
<b>Unselectable image</b>	You attempted to set the print settings for a non-JPEG image.
<b>Cannot complete !</b>	Could not save the print or transfer settings.
<b>Exx</b>	Camera malfunctioned. Turn off the power and turn on again, then re-shoot or play back. If the same message recurs frequently, the camera may be damaged. Note the error number [xx] and take the camera to a Customer Support Help Desk. If this message appears immediately after you have taken a shot, the camera may not have shot the image. Switch to the Playback mode and check whether the image was actually recorded.

# Troubleshooting

Problem	Cause	Solution
The camera will not operate	Power is not turned on.	● Press the Power button for a few moments.
	Memory card slot cover or battery cover is open.	● Be sure the cover is closed securely.
	Batteries are loaded in the wrong direction.	● Reload the batteries in the correct direction.
	Batteries are depleted.	● Replace with unused alkaline or fully recharged batteries (two AA-size batteries). ● Use an AC Adapter Kit ACK800 (sold separately).
	Batteries are not the right type.	● Use only unused AA-size alkaline batteries or Canon AA-size NiMH batteries. (For information about alkaline batteries, see <i>Proper Battery Handling</i> (p. 16).)
	Poor contact between camera and battery terminals.	● Wipe the battery terminals with a clean dry cloth. ● Reload the batteries several times.
The camera will not record	Camera is in Playback mode.	● Change to the Shooting mode.
	Flash is charging.	● Wait until the flash charges. You can press the shutter button when the upper indicator lights orange.

The camera will not record	Memory card is full.	<ul style="list-style-type: none"> <li>● Insert a new memory card.</li> <li>● If required, download the images to a computer and erase them from the memory card to make space.</li> </ul>
	Memory card is not formatted correctly.	<ul style="list-style-type: none"> <li>● Format the memory card. (See <i>Formatting Memory Cards</i> (p. 19).)</li> <li>● If reformatting does not work, the memory card logic circuits may be damaged. Contact the nearest Canon Customer Help Desk.</li> </ul>
	The SD card (sold separately) is write-protected.	<ul style="list-style-type: none"> <li>● Slide the write protect tab of the SD card upward.</li> </ul>
Cannot play back	You attempted to play back images shot with another camera or images edited with a computer.	<ul style="list-style-type: none"> <li>● Computer images that cannot be played back will playback if they are added to the camera using the bundled software program ZoomBrowser EX or ImageBrowser. See the <i>ZoomBrowser EX/ImageBrowser Software User Guide</i> (PDF).</li> </ul>
	File name was changed with a computer or file location was changed.	<ul style="list-style-type: none"> <li>● Set the file name or file number according to the Design rule for Camera File system standards. (See <i>About File and Folder Numbers</i> (p. 116).)</li> </ul>
Lens will not retract	Battery cover or memory card slot cover opened with camera on.	<ul style="list-style-type: none"> <li>● Close the memory card slot cover or battery cover, then turn off the camera.</li> </ul>
	Battery cover or memory card slot cover opened while recording to the memory card (warning signal sounds).	<ul style="list-style-type: none"> <li>● Close the memory card slot cover or battery cover, then turn off the camera.</li> </ul>



Batteries consumed quickly	Batteries are not the right type.	<ul style="list-style-type: none"> <li>● Use only unused AA-size alkaline batteries or Canon AA-size NiMH batteries. (For information about alkaline batteries, see <i>Proper Battery Handling</i> (p. 16).)</li> </ul>
	Battery capacity drops due to low ambient temperatures.	<ul style="list-style-type: none"> <li>● If shooting in a cold area, keep the batteries warm (by placing them in an inner pocket, etc.) until ready to use them.</li> </ul>
	Battery terminals are dirty.	<ul style="list-style-type: none"> <li>● Wipe them well with a dry cloth before use.</li> <li>● Reload the batteries several times.</li> </ul>
	Batteries have not been used for over a year.	<ul style="list-style-type: none"> <li>● If using rechargeable batteries: Performance should return to normal after several charging cycles.</li> </ul>
	If using rechargeable batteries: Battery life exceeded.	<ul style="list-style-type: none"> <li>● Replace both batteries with new ones.</li> </ul>
If using rechargeable batteries: Batteries do not charge in separately sold battery charger	Batteries were placed in the charger in the wrong direction.	<ul style="list-style-type: none"> <li>● Put batteries back into the charger in the correct direction.</li> </ul>
	Poor electrical contact, between batteries and the charger.	<ul style="list-style-type: none"> <li>● Be sure to set batteries firmly into the charger.</li> <li>● Be sure that the power cord is firmly connected to the charger, and is firmly plugged in to the power outlet.</li> </ul>
	Battery terminals are dirty.	<ul style="list-style-type: none"> <li>● Wipe them well with a dry cloth before charging.</li> </ul>
	Battery life exceeded.	<ul style="list-style-type: none"> <li>● Replace both batteries with new ones.</li> </ul>

<p>Sounds come from the camera interior</p>	<p>The camera's vertical and horizontal orientation has changed.</p>	<ul style="list-style-type: none"> <li>● The mechanism for detecting the camera's orientation is functioning. This is not a malfunction.</li> </ul>
<p>Image is blurred or out of focus</p>	<p>Camera moved</p>	<ul style="list-style-type: none"> <li>● Hold the camera steady while pressing the shutter button.</li> </ul>
	<p>Autofocus function hampered by obstruction to AF-assist beam.</p>	<ul style="list-style-type: none"> <li>● Be careful not to block the AF-assist beam with fingers or other items.</li> </ul>
	<p>The AF-assist beam is set to [Off].</p>	<ul style="list-style-type: none"> <li>● Set the [AF-assist beam] to [On] (p. 69).</li> </ul>
	<p>Subject out of focal range.</p>	<ul style="list-style-type: none"> <li>● Ensure that there is at least 45 cm (1.5 ft.) between the camera lens and subject.</li> <li>● Use the Macro mode to shoot close-ups between 5 and 45 cm (2.0 in. to 1.5 ft.) from the lens when set to wide angle and between 30 to 45 cm (11.8 in. to 1.5 ft.) when set to telephoto.</li> </ul>
	<p>Subject is hard to focus on.</p>	<ul style="list-style-type: none"> <li>● Use the focus lock or the manual focus to shoot the image. (See <i>Shooting Hard-to-Focus Subjects</i> (p. 90).)</li> </ul>



Subject in recorded image is too dark	Insufficient light for shooting.	● Set the flash on.
	Subject is dark in comparison to the background.	● Set the exposure compensation to a positive (+) value or use the spot metering function.
	Subject is too far for flash to reach.	● When the flash is used, the distance between lens and subject should not exceed 3.5 m (11.5 ft.) at wide angle and 2.2 m (7.2 ft.) at telephoto. ● Raise the ISO sensitivity and then shoot. (See <i>Changing the ISO Speed</i> (p. 87).)
Subject in recorded image is too bright	Subject is too close causing flash to be too bright.	● When the flash is used, the distance between lens and subject should be no less than 45 cm (1.5 ft.).
	Subject is bright in comparison to the background	● Set the exposure compensation to a negative (-) value or use the spot metering function.
	Light is shining directly or reflected off subject into the camera.	● Adjust the camera angle.
	Flash is set to On	● Set the flash to any other mode except On.
A vertical bar of light (red, purple) appears on the LCD monitor	Subject is too bright.	● This is a normal occurrence in devices containing CCDs and does not constitute a malfunction. (This red bar of light will not be recorded when shooting still photos, but it will be recorded when shooting movies.)

## Troubleshooting

White dots or white asterisks appear on the image	<p>Light from the flash has reflected off dust particles or insects in the air. This occurs more frequently in the following conditions:</p> <ul style="list-style-type: none"> <li>- When shooting at the wide angle end.</li> <li>- When shooting with a high aperture value in the aperture-priority AE mode.</li> </ul>	<ul style="list-style-type: none"> <li>● This is a phenomenon that occurs with digital cameras and does not constitute a malfunction.</li> </ul>
Flash will not fire	Flash is set to Off	<ul style="list-style-type: none"> <li>● Set the flash to On.</li> </ul>
Images are not appearing correctly on a TV screen	Incorrect video system setting.	<ul style="list-style-type: none"> <li>● Set the video system to the appropriate setting, NTSC or PAL, for your TV (p. 115).</li> </ul>
	Shooting mode set to  (Stitch Assist).	<ul style="list-style-type: none"> <li>● The output will not appear on a TV monitor in  (Stitch Assist) mode. Shoot in a different shooting mode.</li> </ul>
Zoom does not operate	Zoom lever was pressed while shooting in Movie mode.	<ul style="list-style-type: none"> <li>● Operate the zoom before shooting in Movie mode.</li> </ul>
Reading images from memory card is slow	Currently used memory card was formatted in another device.	<ul style="list-style-type: none"> <li>● Use a memory card formatted in your camera. See <i>Formatting Memory Cards</i> (p. 19).</li> </ul>
Recording images to memory card takes a long time		

## Using the Power Kits (Sold Separately)

### Using Rechargeable Batteries

#### (Battery and Charger Kit CBK4-200)

This kit includes a battery charger and four rechargeable AA-size NiMH (nickel metal hydride) batteries. Charge batteries as shown below.

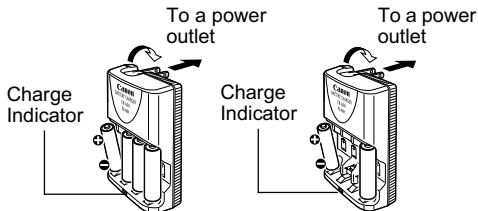

**Charging four batteries**

**Charging two batteries**

Two batteries can be charged instead of four.

The charge indicator blinks while charging, then remains lit when charging is finished.



Although four batteries are supplied with the Battery and Charger Kit CBK4-200, this camera requires two batteries.



- This charger can be used only to charge Canon AA-size NiMH batteries NB-2AH. Please do not attempt to charge NB-2AH batteries in any other type of charger.
- Never mix new batteries together with batteries that have been used in other devices.
- When recharging batteries from the camera, always recharge both of them at the same time.
- Do not mix batteries with different purchase dates or different charge states.
- Do not attempt to recharge fully charged batteries, as doing so may reduce or impair battery performance. Also, do not charge batteries for more than 24 consecutive hours.
- Do not recharge batteries in enclosed areas that tend to retain heat.
- Repeatedly recharging batteries before they become fully depleted may cause batteries to lose capacity. Do not recharge the batteries until the LCD monitor displays the "Change the batteries" message.

- Wipe the battery terminals well with a dry cloth in the following situations, as the terminals may be soiled with oil from one's skin or other dirt:
  - If the battery usage time has considerably diminished
  - If the number of recordable images has considerably diminished
  - When charging the batteries (insert and remove the batteries two or three times before charging)
  - When charging completes in a matter of a few minutes (the battery charger indicator remains lit)
- You may not be able to fully charge the batteries due to their specifications right after purchase or after long periods of non-use. If this happens, use the batteries until their charge is depleted before charging them again. After doing this several times, battery performance will be restored.

- Since storing fully charged batteries for long periods of time (about 1 year) can shorten their lifecycle or affect performance, you are recommended to use the batteries in the camera until they are completely discharged and to store them at normal temperature (0 to 30°C/32 to 90°F) or less. If you do not use the batteries for long periods of time, charge them fully and discharge them fully in the camera at least once a year before returning them to storage.
- If battery usage time is considerably low despite their terminals being wiped and the battery charger's indicator remaining lit, it is possible that the batteries have reached the end of their lifespan. Switch to different, unused batteries. If you are purchasing new batteries, look for Canon's AA-size NiMH batteries.
- Leaving batteries in the camera or charger may damage it causing battery leakage. Remove batteries from the camera or charger and store in a dry cool location when not in use.



- It takes approximately 110 minutes when two batteries are loaded one at each end of the charger and 250 minutes with four for the charger to fully recharge them (as determined by testing at Canon facilities). Please do not charge batteries in areas where the temperature is outside the range of 0 to 35°C (32 to 95°F).
- Charging time varies according to ambient temperature and to the batteries' initial charge state.
- The battery charger may emit noise while charging. This is not a malfunction.
- Battery/Charger Kit CBK100 can also be used. Use Canon AA-size batteries NB-1AH with the charger included in the CBK 100 kit.

## Using the AC Adapter Kit ACK800

Use of AC Adapter Kit ACK800 (sold separately) is recommended when using the camera continuously for prolonged periods of time and when connecting to a computer.



Be sure that the camera is turned off before connecting or disconnecting the compact power adapter.

- 1 Connect the power cord to the compact power adapter, and then plug the other end into the power outlet.**

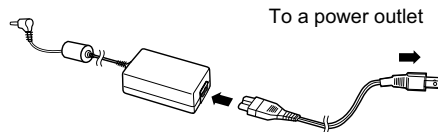

- 2** Open the terminal cover, and connect the compact power adapter's DC plug into the camera's DC IN terminal.

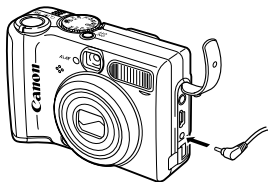

- Please unplug the adapter from the power outlet when you have finished using the camera.



Use of an AC adapter kit other than AC Adapter Kit ACK800 may cause a malfunction in the camera or AC adapter kit.

## Using the Lenses (Sold Separately)

The camera supports use of the separately sold Wide Converter WC-DC52, Tele-converter TC-DC52A and Close-up Lens 250D (52 mm). In order to attach any of these lenses, you also need to use the separately sold Conversion Lens Adapter LA-DC52F.



- When attaching the wide converter, tele-converter or close-up lens, be sure to screw it on securely. If they come loose they may fall from the lens adapter, posing risk of injury from shattered glass.
- Never look into the sun or into strong light through the wide converter, tele-converter or the close-up lens, as this can result in blindness or impairment of vision.



- If you use the flash when shooting with these attachments, the outer area of the recorded image (especially lower right corner) will come out relatively dark.
- When using the tele-converter, please set the focal length to the telephoto end. At other zoom settings, the image will appear as if its corners have been cut off.
- When using the wide converter, please set the camera to the wide angle end.
- If you use the viewfinder for shooting, a portion of the view will be blocked by these attachments.

### Wide Converter WC-DC52

Use this converter for taking wide-angle shots. The wide converter changes the focal length of the camera body's lens by a factor of 0.7x (the thread diameter is 52 mm.).

### Tele-converter TC-DC52A

This 52 mm-threaded diameter magnifying conversion lens is for taking telephoto shots. The lens changes the focal length of the camera body's lens by a factor of 1.75x.

### Close-Up Lens 250D (52 mm)

This lens makes it easy to take macro shots. With the camera set to Macro mode, you can use this option to shoot subjects that are 4 to 17 cm (1.6 to 6.7 in.) away from the front of the lens at the wide angle end, and 14 to 17 cm (5.5 to 6.7 in.) at the telephoto end.



It is not possible to attach a lens hood or filter to the wide converter or tele-converter.

### Shooting Ranges in Macro Mode

	Distance between Front of the Lens and Subject	Field Coverage
Telephoto End	14 cm (5.5 in.)	39 x 29 mm (1.5 x 1.1 in.)
	17 cm (6.7 in.)	46 x 34 mm (1.8 x 1.3 in.)
Wide Angle End	4 cm (1.6 in.)	56 x 42 mm (2.2 x 1.7 in.)
	17 cm (6.7 in.)	165 x 124 mm (6.5 x 4.9 in.)

## Conversion Lens Adapter LA-DC52F

This separately sold adapter is required for attaching the wide converter, tele-converter and close-up lens (52 mm thread diameter).

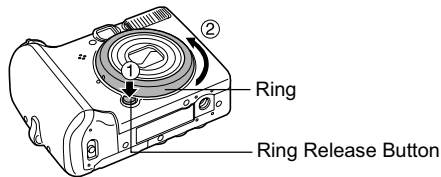

### Attaching a Lens

- 1** Be sure that the camera is turned off.
- 2** Press the ring release button and hold it down, and turn the ring in the direction of the arrow.

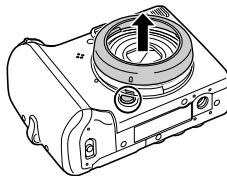

- 3** When the  mark on the camera and the  mark on the ring are aligned, lift off the ring.



- 4** Align the  mark on the conversion lens adapter with the  mark on the camera, and turn the adapter in the direction of the arrows as far as the  mark on the camera.

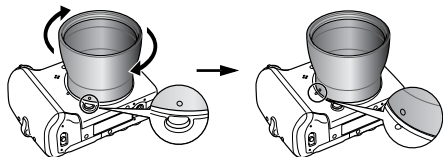



- To remove the conversion lens adapter, turn the adapter in the opposite direction with holding down the ring release button.

**5 Set the lens on the adapter, and attach it securely by turning it in the indicated direction.**

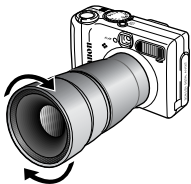

- Completely remove all dust and dirt from conversion lenses with a lens blower brush before use. The camera may focus on any dirt that remains.
- Exercise due caution when handling the lenses since it is easy to dirty them with finger prints.
- Be careful not to drop the camera or adapter when removing the ring.
- When shooting with these attachments, please use the LCD monitor to compose your shots. The attachments block part of the view through the viewfinder, and the area shown in the viewfinder does not match the area of the shot that is actually recorded. Also, the angle of view cannot be confirmed in the viewfinder.
- You should not shoot images in  mode when using these attachments. Although it is possible to select this mode at the camera, the PhotoStitch software will not be able to stitch the images together at the computer.

## Using an Externally Mounted Flash (Sold Separately)

### High Power Flash HF-DC1

This is an attachable supplementary flash. Photographic subjects that are too distant for the built-in flash to illuminate may be captured using the High-Power Flash. Affix the High-Power Flash to the camera using the bracket as shown below. Please also refer to the user's manual supplied with the flash.

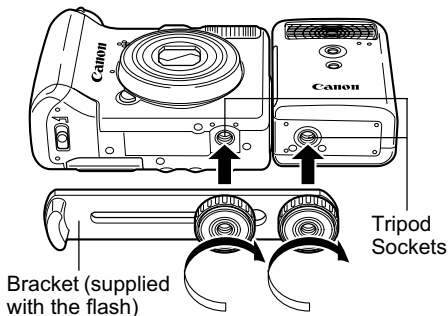

- The High-Power Flash will not fire when the shooting mode dial is set to **M**.
- The flash charge time will lengthen as the battery charge gets weaker. Always set the power/mode switch to [OFF] when you finish using the flash.
- Be careful not to touch the flash window or sensor windows with your fingers while the flash is in use.
- In outdoor settings in the daylight, the flash may not detect illumination from the camera's built-in flash and may not fire.
- The flash may fire if another flash is being used in close proximity.
- The flash may not fire if there are no reflective items in its metering field.
- For continuous shooting, although the flash fires for the first shot, it does not fire for subsequent shots.
- If the battery usage time has considerably diminished, wipe the battery terminals well with a dry cloth as the terminals may be soiled with oil from one's skin or other dirt.

- If the battery is used in cold regions (0°C/ 32°F or lower), you are recommended to carry a spare lithium battery (CR123A or DL123). Keep the spare battery warm in your pocket until immediately before using it, and exchange it frequently with the battery in the flash.
- Remove the battery from the flash and store it in a dry and cool location if you will not use it for extended periods. Leaving it in the flash could lead to the battery leaking and damaging the flash.
- Fasten the attachment screws securely so that they do not loosen. Failure to do so may lead to the dropping of the camera and flash resulting in damage to both.



- Before affixing the bracket to the flash, check that the lithium battery (CR123A or DL123) is installed.
- To illuminate the subjects properly, install the flash so that it is up against the side of the camera and parallel with the camera's front panel.
- A tripod can be used even when the flash is attached.

## Replacing the Date Battery

If the Date/Time menu appears when the camera power is turned on, the date battery charge is low and the date and time settings have been lost. Please purchase a lithium coin battery (CR1220) and replace it as follows.

**Please note that the first date battery may appear to expire relatively quickly after you purchase the camera. This is because it is installed in the camera at the point of manufacture, not when you make the purchase.**



Be particularly careful to keep the date batteries out of the reach of children. Seek medical assistance immediately if a child swallows a battery since corrosive battery fluids could damage the stomach or intestinal wall.

- 1 Confirm that the camera is turned off.**

- 2** Open the terminal cover and use your finger nail to pull out the battery holder.

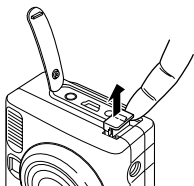

- 3** Pull open the battery holder in the direction indicated by the arrow (①). Remove the battery by pulling it up in the direction indicated by the arrow (②).

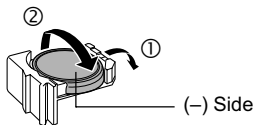

- 4** Insert a new battery with the (-) side facing up.
- 5** Replace the battery holder back and close the terminal cover.
- 6** When the Date/Time menu appears, set the date and time (p. 22).



After purchasing the camera and turning on the power for the first time, although the Date/Time menu will appear, you do not need to replace the date battery.

If you ever dispose of your camera, first remove the date battery for recycling according to the recycling system of your country.



## Camera Care and Maintenance

---

Use the following procedures to clean the camera body, lens, viewfinder, LCD monitor and other parts.

---

**Camera Body** : Wipe the camera body with a soft cloth or an eyeglass lens wiper.

---

**Lens** : First use a lens blower brush to remove dust and dirt, then remove any remaining dirt by wiping the lens lightly with a soft cloth.

- Never use synthetic cleansers on the camera body or lens. If dirt remains, contact the closest Canon Customer Support Help Desk as listed on the separate *Canon Customer Support* leaflet.
- 

**LCD Monitor, Viewfinder** : Use a lens blower brush to remove dust and dirt. If necessary, gently wipe the viewfinder and LCD monitor with a soft cloth or an eyeglass lens wiper to remove stubborn dirt.

- Never rub or press forcefully on the LCD monitor. These actions may damage it or lead to other problems.
- 



Never use water, paint thinner, benzene, or detergents to clean the camera, as these may cause damage or deformation.

# Specifications

All data is based on Canon's standard testing methods. Subject to change without notice.

## PowerShot A520/PowerShot A510

Camera Effective Pixels	PowerShot A520: Approx. 4.0 million PowerShot A510: Approx. 3.2 million
Image Sensor	PowerShot A520: 1/2.5-inch CCD (Total number of pixels: Approx. 4.2 million) PowerShot A510: 1/2.5-inch CCD (Total number of pixels: Approx. 3.3 million)
Lens	5.8 (W) – 23.2 (T) mm (35mm film equivalent: 35 (W) – 140 (T) mm) f/2.6 (W) – f/5.5 (T)
Digital Zoom	PowerShot A520: Approx. 3.6x (Up to approx. 14x in combination with the optical zoom) PowerShot A510: Approx. 3.2x (Up to approx. 13x in combination with the optical zoom)
Optical Viewfinder	Real-image zoom viewfinder
LCD Monitor	1.8-inch, low-temperature polycrystalline silicon TFT color LCD, approx. 115,000 pixels
AF System	TTL autofocus Focus lock and Manual focus are available 9-point AiAF/1-point AF (fixed to center)
Shooting Distance (from the front of the lens)	Normal: 45 cm (1.5 ft.) – infinity Macro: 5 – 45 cm (2.0 in. – 1.5 ft.) (W)/30 – 45 cm (11.8 in. – 1.5 ft.) (T) Manual Focus: 5 cm (2.0 in.) – infinity (W)/30 cm (11.8 in.) – infinity (T)
Shutter	Mechanical shutter + electronic shutter

(W): Wide angle (T): Telephoto

Shutter Speeds	15 – 1/2000 sec. ● The shutter speed varies according to the shooting modes. ● Slow shutter speeds of 1.3 sec. or slower operate with noise reduction.
Metering System	Evaluative, Center-weighted average or Spot (Center)
Exposure Control System	Program AE, Shutter-priority AE, Aperture-priority AE, Manual exposure control
Exposure Compensation	±2 stops in 1/3-stop increments
Sensitivity	Auto*, ISO 50/100/200/400 equivalent * Camera automatically sets the optimal speed.
White Balance	Auto, pre-set (available settings: Daylight, Cloudy, Tungsten, Fluorescent or Fluorescent H) or custom
Built-in Flash	Auto*, on*, off * Red-eye reduction available.
Flash Range	Normal: 45 cm – 3.5 m (1.5 – 11.5 ft.) (W), 45 cm – 2.2 m (1.5 – 7.2 ft.) (T) Macro: 30 – 45 cm (11.8 in. – 1.5 ft.) (W/T) (when sensitivity is set to Auto)
Shooting Modes	Auto Creative zone: Program, Shutter-speed priority, Aperture priority, Manual Image zone: Portrait, Landscape, Night scene, Fast shutter, Slow shutter, Special Scene (Foliage, Snow, Beach, Fireworks, Underwater, Indoor, Kids & Pets and Night Snapshot), Stitch assist and Movie
Continuous Shooting	PowerShot A520: Approx 1.9 shots/sec. PowerShot A510: Approx 2.3 shots/sec. (Large/Fine mode, LCD monitor off).

Specifications	
Self-timer	Activates shutter after an approx. 10-sec./2-sec. delay. Can be set using the custom settings.
PC-controlled Shooting	Available (USB connection only. Exclusive software program is included in the camera kit.)
Recording Media	SD memory card/MultiMediaCard
File Format	Design rule for camera file system and DPOF compliant
Data Type	Still images: Exif 2.2 (JPEG)*1, Movies: AVI (Image data: Motion JPEG; Audio data: WAVE (monaural))
Compression	Superfine, Fine, Normal
Number of Recording Pixels	Still Images Large: PowerShot A520: 2272 x 1704 pixels PowerShot A510: 2048 x 1536 pixels Medium 1: 1600 x 1200 pixels Medium 2: 1024 x 768 pixels Small: 640 x 480 pixels
	Movies 640 x 480 pixels (30 sec.)/320 x 240 pixels (3 min.)/160 x 120 pixels (3 min.) [640]: 10 frames/sec., [320] [160]: 15 frames/sec. The data in parentheses refer to the maximum movie length per shooting.
Playback Modes	Single (histogram displayable), Index (9 thumbnail images), Magnified (approx. 10x (max.) in LCD monitor, advance or reverse through magnified images possible), Auto play, Sound memos (up to 60 sec.) or Movie.
Direct Print	Canon Direct Print and Bubble Jet Direct compatible, and PictBridge compliant



Display Languages	21 languages available for menus and messages (English, German, French, Dutch, Danish, Finnish, Italian, Norwegian, Swedish, Spanish, Simplified Chinese, Russian, Portuguese, Greek, Polish, Czech, Hungarian, Turkish, Traditional Chinese, Korean and Japanese)
My Camera Settings	The start-up image, start-up sound, operation sound, self-timer sound and shutter sound can be customized using the following methods: 1. Using the images and sounds recorded on a camera. 2. Using downloaded data from your computer using the supplied software.
Interface	USB (mini-B, PTP [Picture Transfer Protocol]) Audio/Video output (NTSC or PAL selectable, monaural audio)
Power Source	AA-size alkaline batteries (included in the camera kit) AA-size rechargeable NiMH batteries NB4-200 (sold separately) AC Adapter Kit ACK800 (sold separately)
Operating Temperatures	0 – 40°C (32 – 104°F)
Operating Humidity	10 – 90%
Dimensions	90.7 x 64.0 x 38.4 mm (3.6 x 2.5 x 1.5 in.) (excluding protrusions)
Weight	Approx. 180 g (6.3 oz.) (camera body only)

\*1 This digital camera supports Exif 2.2 (also called “Exif Print”). Exif Print is a standard for enhancing the communication between digital cameras and printers. By connecting to an Exif Print-compliant printer, the camera’s image data at the time of shooting is used and optimized, yielding extremely high quality prints.

## Battery Performance

	Number of Shots		Playback Time
	LCD Monitor ON (Based on the CIPA standard)	LCD Monitor Off	
<b>AA Alkaline Batteries (included with the camera)</b>	Approx. 80 shots	Approx. 240 shots	Approx. 180 min.
<b>AA NiMH Batteries (NB-2AH (fully charged))</b>	Approx. 300 shots	Approx. 800 shots	Approx. 300 min.

\* The actual figures will vary according to the shooting condition and settings.

## Test Conditions

**Shooting:** Normal temperature (23°C ±2°C/73°F ±3.6°F), normal relative humidity (50% ±20%), alternating wide angle end and telephoto end shots at 30 second intervals with the flash fired once every two shots and the camera power turned off after every tenth shot. Power is left off for a sufficient amount of time\*, then the power is turned back on and the testing procedure is repeated.

- The included memory card is used.

\* Until the battery returns to normal temperature

**Playback:** Normal temperature (23°C ±2°C/73°F ±3.6°F), normal relative humidity (50% ±20%), continuous playback at 3 seconds per image.

● **For information on handling batteries, see *Proper Battery Handling* (p. 16).**

## Memory Cards and Estimated Capacities (Recordable Images)









Memory card included with the camera

### PowerShot A520







			MMC-16M	SDC-128M	SDC-512MSH
L (Large) 2272 x 1704 pixels			7	61	237
			13	109	425
			26	216	838
M1 (Medium 1) 1600 x 1200 pixels			14	121	471
			26	216	838
			50	411	1589
M2 (Medium 2) 1024 x 768 pixels			25	211	816
			45	372	1438
			80	651	2517
S (Small) 640 x 480 pixels			56	460	1777
			87	711	2746
			138	1117	4316
Movie	640 x 480 pixels		22 sec.	3 min. 1 sec.	11 min. 42 sec.
	320 x 240 pixels		43 sec.	5 min. 55 sec.	22 min. 53 sec.
	160 x 120 pixels		1 min. 47 sec.	14 min. 29 sec.	55 min. 57 sec.

### PowerShot A510

			MMC-16M	SDC-128M	SDC-512MSH
L (Large) 2048 x 1536 pixels			9	76	295
			16	136	529
			33	269	1041
M1 (Medium 1) 1600 x 1200 pixels			14	121	471
			26	216	838
			50	411	1589
M2 (Medium 2) 1024 x 768 pixels			25	211	816
			45	372	1438
			80	651	2517
S (Small) 640 x 480 pixels			56	460	1777
			87	711	2746
			138	1117	4316
Movie	640 x 480 pixels		22 sec.	3 min. 1 sec.	11 min. 42 sec.
	320 x 240 pixels		43 sec.	5 min. 55 sec.	22 min. 53 sec.
	160 x 120 pixels		1 min. 47 sec.	14 min. 29 sec.	55 min. 57 sec.

- Some memory cards are not sold in some regions.
- The maximum movie clip length is : 30 sec., : 3 min. or : 3 min.. The times shown are the maximum continuous recording times.
- \* When using a 128 MB or higher capacity memory card.
-  (Superfine),  (Fine) and  (Normal) indicate the compression setting.
- **L** (Large), **M1** (Medium 1), **M2** (Medium 2), **S** (Small), ,  and  indicate the recording resolution.

### Image Data Size (Estimated)

				
<b>L</b>	<b>PowerShot A520: 2272 x 1704 pixels</b>	2002 KB	1116 KB	556 KB
	<b>PowerShot A510: 2048 x 1536 pixels</b>	1602 KB	893 KB	445 KB
<b>M1</b>	<b>1600 x 1200 pixels</b>	1002 KB	558 KB	278 KB
<b>M2</b>	<b>1024 x 768 pixels</b>	570 KB	320 KB	170 KB
<b>S</b>	<b>640 x 480 pixels</b>	249 KB	150 KB	84 KB
<b>Movie</b>	 <b>640 x 480 pixels</b>	660 KB/sec.		
	 <b>320 x 240 pixels</b>	330 KB/sec.		
	 <b>160 x 120 pixels</b>	120 KB/sec.		

## NiMH Battery NB-2AH

Supplied with the separately sold NiMH Battery NB4-200 set and the Battery and Charger Kit CBK4-200.

<b>Type</b>	Rechargeable nickel metal hydride battery
<b>Nominal Voltage</b>	1.2 V DC
<b>Typical Capacity</b>	2300 mAh (min.: 2150 mAh)
<b>Cycle Life</b>	Approx. 300 times
<b>Operating Temperatures</b>	0 – 35°C (32 – 95°F)
<b>Dimensions</b>	Diameter: 14.5 mm (0.6 in.) Length: 50 mm (2.0 in.)
<b>Weight</b>	Approx. 29 g (1.0 oz.)

## Battery Charger CB-4AH/CB-4AHE

Supplied with the separately sold Battery and Charger Kit CBK4-200.

<b>Rated Input</b>	100 – 240 V AC (50/60 Hz), 10 W
<b>Rated Output</b>	565 mA* <sup>1</sup> , 1275 mA* <sup>2</sup>
<b>Charging Time</b>	Approx. 250 min.* <sup>1</sup> , Approx. 110 min.* <sup>2</sup>
<b>Operating Temperatures</b>	0 – 35°C (32 – 95°F)
<b>Dimensions</b>	65.0 x 105.0 x 27.5 mm (2.6 x 4.1 x 1.1 in.)
<b>Weight</b>	CB-4AH: Approx. 95 g (3.4 oz.) CB-4AHE: Approx. 97 g (3.4 oz.) (body only)

\*<sup>1</sup> To charge four NB-2AH NiMH batteries

\*<sup>2</sup> To charge two NB-2AH NiMH batteries loaded one at each end of the battery charger

**Compact Power Adapter CA-PS800**

Supplied with the separately sold AC Adapter Kit ACK800.

<b>Rated Input</b>	100 – 240 V AC (50/60 Hz), 16 VA (100 V) – 26 VA (240 V)
<b>Rated Output</b>	DC 3.15 V DC/2 A
<b>Operating Temperatures</b>	0 – 40°C (32 – 104°F)
<b>Dimensions</b>	42.5 x 104.0 x 31.4 mm (1.7 x 4.1 x 1.2 in.)
<b>Weight</b>	Approx. 180 g (6.3 oz.) (body only)

**SD memory Card**

<b>Interface</b>	Interface conforming to SD memory card standards.
<b>Dimensions</b>	32.0 x 24.0 x 2.1 mm (1.3 x 0.9 x 0.08 in.)
<b>Weight</b>	Approx. 2 g (0.07 oz.)

**MultiMediaCard**

<b>Interface</b>	Compatible with MultiMediaCard standards.
<b>Dimensions</b>	32.0 x 24.0 x 1.4 mm (1.3 x 0.9 x 0.06 in.)
<b>Weight</b>	Approx. 1.5 g (0.05 oz.)

## Wide Converter WC-DC52 (Sold Separately)

<b>Magnification</b>	Approx. 0.7x (35 mm film equivalent at wide angle end: approx. 24.5 mm)
<b>Focusing Range (from front of lens)</b>	Approx. 21 cm (8.3 in.) – infinity (at wide angle end)* <sup>1</sup> Approx. 1 – 21 cm (0.4 – 8.3 in.) (at wide angle end with using the Macro mode)* <sup>1</sup>
<b>Thread Diameter</b>	52 mm standard filter thread* <sup>2</sup>
<b>Dimensions</b>	Diameter: 58.0 mm (2.3 in.) Length: 30.5 mm (2.2 in.)
<b>Weight</b>	Approx. 74 g (2.6 oz.)

## Close-up Lens 250D 52 mm (Sold Separately)

<b>Focal Length</b>	250 mm
<b>Focusing Range (from front of lens)</b>	4 – 17 cm (1.6 – 6.7 in.) (W) 14 – 17 cm (5.5 – 6.7 in.) (T) (when using the Macro mode)* <sup>1</sup>
<b>Thread Diameter</b>	52 mm standard filter thread* <sup>2</sup>
<b>Dimensions</b>	Diameter: 54 mm (2.1 in.) Length: 10.2 mm (0.4 in.)
<b>Weight</b>	Approx. 55 g (1.9 oz.)

\*<sup>1</sup> When mounted on PowerShot A510.

\*<sup>2</sup> Conversion Lens Adapter LA-DC52F is required when mounted on PowerShot A510.

### Tele-converter TC-DC52A (Sold Separately)

<b>Focal Length</b>	Approx. 1.75x (35mm film equivalent at telephoto end: approx. 245 mm)
<b>Focusing Range (from front of lens)</b>	Approx. 1.4 m (Approx. 4.6 ft.) – infinity (at telephoto end)* <sup>1</sup>
<b>Thread Diameter</b>	52 mm standard filter thread* <sup>2</sup>
<b>Dimensions</b>	Diameter: 55.2 mm (2.2 in.) Length: 49.3 mm (1.9 in.)
<b>Weight</b>	Approx. 86 g (3.0 oz.)

\*<sup>1</sup> When mounted on PowerShot A510.

\*<sup>2</sup> Conversion Lens Adapter LA-DC52F is required when mounted on PowerShot A510.

### Conversion Lens Adapter LA-DC52F (Sold Separately)

<b>Thread Diameter</b>	52 mm standard filter thread
<b>Dimensions</b>	Diameter: 55.6 mm (2.2 in.) Length: 39.1 mm (1.5 in.)
<b>Weight</b>	Approx. 14 g (0.5 oz.)



This section offers photography tips.

## ● **Tip for Using the Self-timer (p. 45)**

Normally, the camera shakes a little when you press the shutter button.

Setting the self-timer to  delays the shutter release for two seconds and allows the camera to stop shaking, thus preventing a blurred image. Even better results can be obtained by placing the camera on a fixed, stable surface or by fixing the camera onto a tripod.

## ● **To Shoot a Night Scene without a Subject (p. 42)**

To shoot a night scene without any subject in the foreground, set the flash to .

(A night scene usually consists of light sources in the night. When shooting with the flash, the light of the flash will washout these lights, so it is better to turn the flash off.)

This mode uses a slow shutter speed so always use a tripod to prevent camera shake.

## ● **Advanced Technique for the Macro Mode (p. 44)**

Macro mode can make unique images when used with the zoom function. For example, shooting a flower at maximum wide angle in Macro mode allows the camera to bring both the flower and the background into focus. However, shooting at maximum telephoto can throw the background out of focus to make the flower stand out.



Macro with the wide angle zoom



Macro with the telephoto zoom

## ● **How to Adjust the Exposure (p. 83)**

This camera automatically adjusts the exposure to shoot images with the optimal brightness. However, recorded images may sometimes be brighter or darker than the actual image depending on the shooting conditions. If this happens, adjust the exposure compensation manually.

### Underexposure

The whole recorded image is dark, which makes white elements of the image appear gray. Shooting bright subjects or in backlit conditions may cause the image to be underexposed. Adjust the exposure compensation towards the + end.



### Optimal Exposure



### Overexposure

The whole recorded image is bright, which makes black elements of the image appear gray. Shooting dark subjects or in dark places may cause the image to be overexposed. Adjust the exposure compensation towards the - end.



### ● ISO Speed (p. 87)

The ISO speed is the numeric representation of the camera's sensitivity to light. The higher the ISO speed, the higher the sensitivity. A high ISO speed allows you to shoot images in dark indoor or outdoor conditions without a flash and also helps prevent blurred images due to camera shake. This is convenient when shooting images in places where flash photography is prohibited. The ISO speed setting makes full use of the available light, resulting in images that convey the feel of the place they were shot.



ISO 50 equivalent



ISO 400 equivalent

## A

AC Adapter Kit .....	131
AF Frame .....	81
Aperture Value .....	79
Aperture-priority AE .....	79
Auto Mode .....	33
Auto Play .....	96
A/V Out Terminal .....	114

## B

### Batteries

Battery Cover .....	15
Handling Precautions .....	16
Installing .....	15
Low Status .....	17
Performance .....	144
Rechargeable Batteries .....	129
Status .....	17

Beep .....	34, 70, 74
------------	------------

## C

Care .....	139
Components .....	12
Compression .....	40
Computer System Requirements .....	107

Continuous Shooting .....	48
Creative Zone .....	76

## D

Date/Time .....	22
Default Settings .....	69 – 74
DIGITAL Terminal .....	12, 109
Digital Zoom .....	47
Direct Transfer .....	111
Display Modes .....	24 – 29
DPOF	
Print Settings .....	100
Transfer Order .....	104

## E

### Erasing

All Images .....	65
Single Image .....	65

### Exposure

Aperture-priority AE .....	79
Compensation .....	83
Shutter-speed Priority AE .....	77

## F

Fast Shutter .....	38
File Number .....	115

Flash .....	42
Focal Length .....	132, 133, 149, 150
Focus	
Lock .....	90
Manual .....	91
Format .....	19

## H

Histogram .....	29
-----------------	----

## I

Image Zone .....	38
Index Playback .....	60
Indicators .....	14
Information View .....	24 – 29
Interface Cable .....	12, 109
ISO Speed .....	87

## J

Jump .....	61
------------	----

## L

Landscape Mode .....	38
Language .....	23
LCD Monitor .....	24 – 29
Lens .....	12

Close-Up Lens .....	133
Conversion Lens Adapter .....	134
Tele-converter .....	133
Wide Converter .....	133

## M

Macro Mode .....	44
Magnifying Images .....	59
Maintenance .....	139
Manual	
Exposure .....	83
Focus .....	91
Shooting Mode .....	80
Memory Card .....	18
Downloading Images .....	113
Formatting .....	19
Installing .....	18
Recording Capacity .....	145
Slot Cover .....	18
Menu	
FUNC. ....	66
My Camera .....	74
Play .....	70
Rec. ....	69
Selecting .....	66
Set up .....	70 – 73

Messages .....	121 – 122
Metering	
Center-Weighted Averaging .....	82
Evaluative .....	82
Spot .....	82
Microphone .....	12
Mode Dial .....	38, 76
Movie	
Editing .....	62
Playback .....	61
Shooting .....	56
My Camera	
Menu .....	74
Registering .....	118
Settings .....	118
<b>N</b>	
Night Scene Mode .....	38
<b>O</b>	
Operation Sound .....	71, 74, 118, 143
<b>P</b>	
Photo Effect .....	88
PictBridge compliant printers .....	98

Playback	
Auto Play .....	96
Index Playback .....	60
Jumping .....	61
Magnifying Images .....	59
Movies .....	61
Rotating .....	94
Single Image Playback .....	58
Portrait Mode .....	38
Postcard Print Mode .....	54
Power On/Off .....	30 – 31
Power Saving .....	31
Power Source .....	30
AC Adapter .....	131
Rechargeable Batteries .....	129
Printing .....	98
Print Style .....	103
Selecting Images .....	100 – 102
Print/Share Button .....	13, 98, 111
Program AE .....	77
Protect .....	97
<b>R</b>	
Recordable Images .....	145
Red-eye Reduction .....	43

Resetting the Settings to Default .....	75
Resolution .....	40
Ring Release Button .....	12
Rotate .....	94

**S**

Self-timer .....	45
Sound .....	74
Shooting .....	33, 66
Reviewing an Image .....	36
TV Set .....	114
Shooting Mode .....	159
Dial .....	14
Functions Available .....	159
Shutter	
Shutter-speed Priority AE .....	77
Sound .....	74
Speed .....	77
Shutter Button .....	33
Single Image Playback .....	58
Slow Shutter .....	38
Sound Memos .....	95
Speaker .....	12
Special Scene Mode .....	51
Specifications .....	140 – 143

Start-up	
Image .....	74
Sound .....	74
Stitch Assist Mode .....	49
Strap .....	13

**T**

Telephoto .....	33
Transfer Order	
Selecting Images .....	104
Troubleshooting .....	123 – 128

**V**

Video System .....	73
Viewfinder .....	13
Autofocus range .....	35
Volume .....	71

**W**

WAVE Files .....	27, 95, 96, 120, 122, 142
White Balance .....	84
Wide angle .....	33

**Z**

Zoom .....	47
------------	----



## FCC Notice

(Digital Camera, Model PC1106/PC1107)

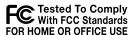

This device complies with Part 15 of the FCC Rules. Operation is subject to the following two conditions;

- (1) this device may not cause harmful interference, and
- (2) this device must accept any interference received, including interference that may cause undesired operation.

Note: This equipment has been tested and found to comply with the limits for Class B digital devices, pursuant to Part 15 of the FCC rules. These limits are designed to provide reasonable protection against harmful interference in a residential installation. This equipment generates, uses and can radiate radio frequency energy and, if not installed and used in accordance with the instructions, may cause harmful interference to radio communications. However, there is no guarantee that interference will not occur in a particular installation. If this equipment does cause harmful interference to radio or television reception, which can be determined by turning the equipment off and on, the user is encouraged to try to correct the interference by one or more of the following measures:

- Reorient or relocate the receiving antenna.
- Increase the separation between the equipment and receiver.
- Connect the equipment into an outlet on a circuit different from that to which the receiver is connected.
- Consult the dealer or an experienced radio/TV technician for help.

The cables with the ferrite core provided with the digital camera must be used with this equipment in order to comply with Class B limits in Subpart B of Part 15 of the FCC rules.

Do not make any changes or modifications to the equipment unless otherwise specified in the manual. If such changes or modifications should be made, you could be required to stop operation of the equipment.

### **Canon U.S.A., Inc.**

One Canon Plaza, Lake Success, NY 11042, U.S.A.  
Tel No. (516) 328-5600

### **Canadian Radio Interference Regulations**

This Class B digital apparatus complies with Canadian ICES-003.

### **Réglementation canadienne sur les interférences radio**

Cet appareil numérique de la classe B est conforme à la norme NMB-003 du Canada.



## Functions Available in Each Shooting Mode

The following chart shows the functions and settings available in each Shooting mode.

Function								SCN <sup>(1)</sup>			<b>P</b>	<b>Tv</b>	<b>Av</b>	<b>M</b>	Reference Pages
Resolution	Large <b>L</b>	○*	○*	○*	○*	○*	○*	○*	△*	—	○*	○*	○*	○*	40
	Medium 1 <b>M1</b>	○	○	○	○	○	○	○	△	—	○	○	○	○	
	Medium 2 <b>M2</b>	○	○	○	○	○	○	○	△	—	○	○	○	○	
	Small <b>S</b>	○	○	○	○	○	○	○	△	—	○	○	○	○	
	Postcard Print	○	○	○	○	○	○	○	—	—	○	○	○	○	54
	Movie	—	—	—	—	—	—	—	—	○	—	—	—	—	40
	Movie	—	—	—	—	—	—	—	—	○*	—	—	—	—	
Movie	—	—	—	—	—	—	—	—	○	—	—	—	—		
Compression	Superfine	○	○	○	○	○	○	○	△	—	○	○	○	○	40
	Fine	○*	○*	○*	○*	○*	○*	○*	△*	—	○*	○*	○*	○*	
	Normal	○	○	○	○	○	○	○	△	—	○	○	○	○	
Flash	Auto	○*	○*	○	○*	○*	○	○*	—	—	○	—	—	—	42
	On	—	○	○	○	○	○	○	△	—	○	○	○	○	
	Off	○	○	○*	○	○	○*	○	△*	—	○*	○*	○*	○*	
<b>Red-eye Reduction</b>	○	○	○	○	○	○	○	△	—	○	○	○	○	43	
<b>Flash Output</b>	—	—	—	—	—	—	—	—	—	—	—	—	○	89	
<b>AF-assist Beam</b>	○	○	○	○	○	○	○	△	○	○	○	○	○	36	

\*: Default settings ○: Available △: Available only for the first image —: Not available

: Setting remains in effect even when the camera is turned off.

Function										SCN <sup>(1)</sup>			P	Tv	Av	M	Reference Pages
Drive Mode	Single Shot	○*	○*	○*	○*	○*	○*	○*	○*	△*	○*	○*	○*	○*	○*	○*	–
	Continuous Shooting	–	○	○	○	○	○	○	○	–	–	○	○	○	○	○	48
	Self-timer (10 sec.)	○	○	○	○	○	○	○	○	△	○	○	○	○	○	○	45
	Self-timer (2 sec.)	○	○	○	○	○	○	○	○	△	○	○	○	○	○	○	
	Custom	○	○	○	○	○	○	○	○	–	–	○	○	○	○	○	
AF Frame selection <sup>(2)</sup>		○*	○	○	○	○	○	○	○	○	○	○	○	○	○	○	81
AF Lock		–	○	○	○	○	○	○	○	–	○	○	○	○	○	○	90
Manual Focus		–	○	○	○	○	○	○	○	–	○	○	○	○	○	○	91
Macro Mode		○	○	–	○	○	○	○	○	△	○	○	○	○	○	○	44
Digital Zoom	ON	○	○	○	○	○	○	○	○	–	–	○	○	○	○	○	47
	OFF	○*	○*	○*	○*	○*	○*	○*	○*	–	–	○*	○*	○*	○*	○*	
Exposure Compensation		–	○	○	○	○	○	○	○	△	○	○	○	○	○	–	83
Metering System	Evaluative	○	○	○	○	○	○	○	○	○	○	○*	○*	○*	○*	82	
	Center-Weighted Averaging	–	–	–	–	–	–	–	–	–	–	○	○	○	○		
	Spot	–	–	–	–	–	–	–	–	–	–	○	○	○	○		
White Balance <sup>(3)</sup> <b>WB</b>		– <sup>(4)</sup>	○	○	○	○	○	○	– <sup>(5)</sup>	△	○	○	○	○	○	○	84
Photo Effect		–	○	○	○	○	○	○	– <sup>(5)</sup>	△	○	○	○	○	○	○	88

Function							SCN <sup>(1)</sup>			P	Tv	Av	M	Reference Pages		
<b>ISO Speed</b>		— <sup>(5)</sup>	— <sup>(5)</sup>	— <sup>(5)</sup>	— <sup>(5)</sup>	— <sup>(5)</sup>	— <sup>(5)</sup>	— <sup>(5)</sup>	— <sup>(5)</sup>	— <sup>(5)</sup>	○	○	○	○ <sup>(6)</sup>	87	
<b>Auto Rotate</b>		ON	○*	○*	○*	○*	○*	○*	○*	△*	—	○*	○*	○*	○*	92
		OFF	○	○	○	○	○	○	○	△	—	○	○	○	○	

The default for the settings changed by the menu and button operations can be restored all at once except for [Date/Time], [Language] and [Video System] (p. 75).

(1) The default setting of the flash for the [Foliage] and [Fireworks] options is [Off].

The following functions cannot be set in the [Fireworks] mode.

- The [Auto] and [On] setting of the flash
- Red-eye reduction function
- AF-assist beam
- AF frame selection
- Macro mode
- AF lock
- Manual focus

The following functions cannot be set in the [Kids & Pets] mode.

- Macro mode
- AF frame selection

(2) When using the digital zoom, AF frame is set to [Off].

(3) Cannot be adjusted when the photo effect is set to [Sepia] or [B/W].

(4) The white balance is set to [Auto].

(5) Settings automatically set by the camera.

(6) ISO [Auto] cannot be selected.