

SAMSUNG
ELECTRONICS

SAMSUNG



Portable DVD Player
DVD-L1200W

UK

AK68-00311C

Notices and Safety Instructions

Safety Instructions

Be sure to read the safety and operating instructions before using this product.
Keep this manual in a safe place for future reference.
Be sure to adhere to all warnings on the product.

1. Unplug the power cord from the AC outlet before cleaning the unit.
Do not use liquid cleaner or aerosol cleaner. Wipe with a damp cloth.

2. Do not use accessories or attachments not recommended by the manufacturer. They may cause hazards.

3. Do not place this unit near water - for example, near a bathtub, kitchen sink or laundry tub, in a wet basement or near a swimming pool.

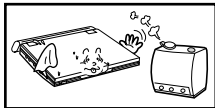

4. Do not place the unit on an unstable stand, rack or table.

The unit may fall, causing serious personal injury or damage to the unit.

Use only a table recommended by the manufacturer, or sold with the unit.

Be sure to install according to the instructions, using the recommended installation accessories.

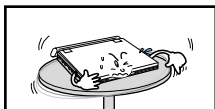

5. The unit should be moved with care. Quick stops, excessive force, and uneven surfaces may cause the unit and cart combination to overturn.



6. Operate the unit using only the type of power source indicated on the marking label. If you are not certain of your voltage requirement, please contact the authorised dealer from whom you purchased the product.
If you want to operate the unit with batteries or other type of power source, please refer to the manual.

7. Route the power cord so that it is not likely to be walked on or pinched by objects placed upon or against it. Pay particular attention to the cord at the plug and the point where it exits from the unit.

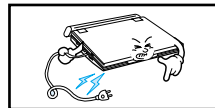

8. During an electrical storm, or when the unit is unused for a long period of time, unplug the power cord from the AC outlet and disconnect the lines between the unit and the antenna. This is to prevent damage caused by lightning and serious injury from electric shock.



9. Do not overload wall outlets or extension cords. This may cause fire or electrical shock.

10. Do not let foreign objects fall into the unit. If a foreign object touches internal parts or some areas inside the unit which are subject to high voltage, this can result in a risk of fire or electrical shock.
Do not spill any liquid into the unit.

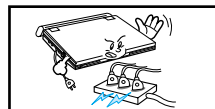

Notices and Safety Instructions

11. Do not attempt to service the unit yourself by opening or removing the covers.
You may be exposed to high voltage and other hazards.
Refer all servicing to qualified service personnel.

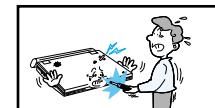

12. When replacement of the AC adapter is necessary, purchase and use the same type of adapter.

13. Make sure the service technician uses replacement parts specified by the manufacturer or parts that have the same characteristics as the original. Unauthorised substitutions may result in fire, electrical shock, or other hazards.

14. Do not place this unit near a radiator, heater, stove, or any other heat-emitting equipment (including amplifiers).



15. Do not view the video on the LCD screen while moving.
Do not play the DVD player or do not view the video while driving or walking.
Doing so may result in a risk of personal injury.

16. Do not apply voltage exceeding the upper limit of the rated voltage for this DVD player.
 - Do not apply voltage outside the voltage range indicated on this DVD player.
 - Using this unit with incorrect voltage can cause fire and/or electric shock.

17. Do not apply excessive force on the display.
 - The outer surface of the screen is made of glass. The glass may break if a strong force is applied.
18. Do not use the DVD player on your lap for a long period of time.
 - You may get a minor burn due to the heat produced by the DVD player.

CAUTION : USE OF ANY CONTROLS, ADJUSTMENTS, OR PROCEDURES OTHER THAN SPECIFIED HEREIN MAY RESULT IN HAZARDOUS RADIATION EXPOSURE.

Notices and Safety Instructions

Copy Protection

- Many DVD discs are encoded with copy protection. Because of this, you should only connect your DVD player directly to your TV, not to a VCR. Connecting to a VCR results in a distorted picture from copy-protected DVD discs.
- This product incorporates copyright protection technology that is protected by methods claims of certain U.S. patents and other intellectual property rights owned by Macrovision Corporation and other rights owners. Use of this copyright protection technology must be authorized by Macrovision Corporation, and is intended for home and other limited viewing uses only unless otherwise authorized by Macrovision Corporation. Reverse engineering or disassembly is prohibited.

Safety Information

Assuring the Finest Performance

This product is designed with the latest technology to provide trouble-free operation. If the pick-up lens or disk drive gets dirty, the video quality will decrease.

Moisture Condensation

Condensation may form inside this player under following conditions:

- If warm air comes in contact with any cold parts inside the player;
- If the player is located in a room with high humidity; and
- If the player is exposed to sudden temperature changes from cold to hot.

When condensation forms inside the player, the player may not operate correctly.

If this occurs, leave the player at room temperature until the inside of the player becomes dry and operational.

Laser Safety

Caution

This product utilizes a laser. Use of controls or adjustments or performance of procedures other than those specified herein may result in hazardous radiation exposure. Do not open covers and do not look inside the product if interlock mechanism is damaged.

Warning

Be careful not to damage the interlock mechanism.

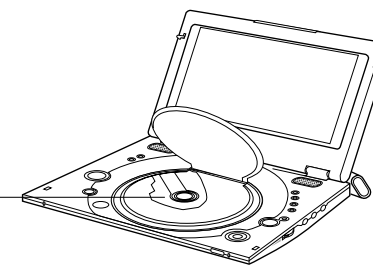

Table of Contents

Setup

Features	8
Accessories	9
Disc Type and Characteristics	10
Description-Front Panel	12
Tour of the Remote Control	15
Using the Remote Control Unit	16

Connections

Connecting Headphones to the DVD	17
Connecting to an External Component (Input Select)	18
Viewing a Video from an External Component	19
Connecting to a TV	20
Connecting to a Stereo Component	21

Adapter directions

Using the AC adapter	24
Using the battery pack	26
Battery level display	27

Basic Functions

Playing a Disc	28
Using the Search & Skip Functions	30
Using the Display Function	31
Using the Disc and Title Menu	32
Using the Function Menu	33
Repeat Play	34

Table of Contents

Advanced Functions

Slow Repeat Play	35
Adjusting the Aspect Ratio (EZ View)	36
Selecting the Audio Language	38
Selecting the Subtitle Language	39
Changing the Camera Angle	40
Using the Bookmark Function	41
Using the Zoom & 3D Sound Functions	42
Clips Menu for MP3/WMA/JPEG	43
Folder Selection	44
MP3/WMA Play	45
Picture CD Playback	47

Changing Setup menu

Using the Setup Menu	49
Setting Up the Language Features	50
Setting Up the Audio Options	52
Setting Up the Display Options	53
Setting Up the Parental Control	54

Reference

Cautionary Notes	55
Troubleshooting	60
Specifications	63
Warranty	64

Features

Plays DVD discs and audio CDs

- CD-R/RW discs containing MP3/WMA files can be played.

12 in. LCD display and built-in stereo speakers

- With the built-in 12 in. LCD display and stereo speakers, you can enjoy a DVD movie without requiring a separate TV.

Convenient 2-Way power supply

- You can use your DVD player virtually anywhere by using the supplied AC adapter indoors and the battery pack outdoors.

Compact size/light-weight design

- Compact and lightweight design makes the player easy to carry.

High-resolution image

- High-resolution LCD screen with 384,000 pixels provides a clear picture.

AV input/output, optical digital output jack

- *¹Dolby Digital 5.1-CH audio and *²DTS digital audio can be output through the optical digital output jack. You can enjoy unsurpassed surround sound when a Dolby Digital/DTS digital surround processor or amplifier is connect to this jack.

- You can connect a VCR or camcorder to your DVD player using the AV input/output jacks or you can connect to a TV for a larger screen.

*¹ Manufactured under license from Dolby Laboratories. "Dolby", "Pro Logic", and the double-D symbol (Ⓛ) are trademarks of Dolby Laboratories. Confidential unpublished works © 1992-1997. Dolby Laboratories. Inc. All rights reserved.



*² "DTS" and "DTS Digital Out" are trademarks of Digital Theater Systems, Inc.

EZ VIEW

- Easy View can convert Letter Box images to full screen viewing on your conventional TV.

INPUT : For viewing a video from an external component such as a VCR, Camcorder etc..

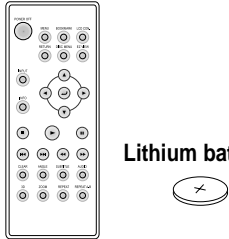
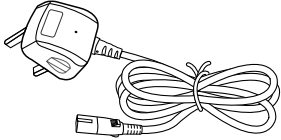
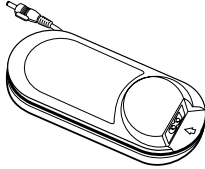
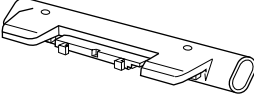
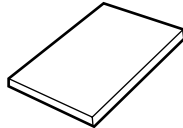
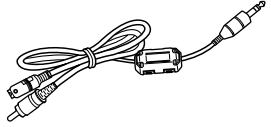
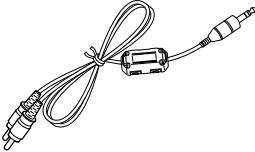
Accessories



<p>Remocon</p> 	<p>AC Cord</p> 	<p>AC power Adapter</p> 	<p>Battery pack</p> 
<p>User's Manual</p> 	<p>Video cable</p> 	<p>Audio cable</p> 	<p>Headphone</p> 

If disc features differ from the explanation in the manual

- Some functions or operations are disc-dependent and may not work in all cases. Follow the instructions shown on the screen. This manual only covers basic disc operations.
- Ⓛ may appear during some operations. This mark indicates that the disc in use does not currently support operations explained in this manual.

Disc Type and Characteristics

This DVD player is capable of playing the following types of discs with the corresponding logos:

Disc Types (Logos)	Recording Types	Disc Size	Max. Playing Time	Characteristics
 DVD	Audio + Video	12cm	Single-sided 240 min. Double-sided 480 min.	<ul style="list-style-type: none"> DVD contains excellent sound and video due to Dolby Digital and MPEG-2 system. Various screen and audio functions can be easily selected through the on-screen menu.
		8cm	Single-sided 80 min. Double-sided 160 min.	
 VIDEO-CD	Audio + Video	12cm	74 min.	<ul style="list-style-type: none"> Video with CD sound, VHS quality & MPEG-1 compression technology.
		8cm	20 min.	
 AUDIO-CD	Audio	12cm	74 min.	<ul style="list-style-type: none"> CD is recorded as a Digital Signal with better audio quality, less distortion and less deterioration of audio quality over time.
		8cm	20 min.	

*** Caution 1**



- Play Region Number



- PAL broadcast system in U.K, France, Germany, etc.



- Dolby Digital disc



- Stereo disc



- Digital Audio disc



- DTS disc



- MP3 disc

NOTE:

- * Discs which cannot be played with this player:
 - DVD-ROM • DVD-RAM
 - CD-ROM • CDV
 - CDI
 - HD layer of super Audio CD
 - CDGs play audio only, not graphics.
- * Ability to play back may depend on recording conditions:
 - DVD-R • CD - RW
 - DVD+RW, -RW
 - Picture CD
- * It may not play CD-R, CD-RW and DVD-R in all cases due to the type of disc or condition of the recording.
- * It plays a VCD 2.0 disc as a VCD 1.1 mode (MENU OFF Mode).

Play Region Number

Both the DVD player and the discs are coded by region. These regional codes must match in order for the disc to play. If the codes do not match, the disc will not play.
The Region Number for this player is described on the housing bottom of the player.

Disc Type and Characteristics

*** Caution 2**

- Some playback functions of a DVD vary by manufacturer. This DVD player reproduces the disc data according to guidelines provided by the disc manufacturer. If  appears during disc operations, the disc manufacturer has placed a limit on that function.

*** Caution 3**

- The LCD display does not support Closed Captions. However, you can view captions by connecting this unit to a TV with the caption function.

Discs that cannot be played

- Illegally manufactured discs
- Disc with scratches; and
- Disc with fingerprints, dirt, and debris.
 - If the disc surface has dirt or scratches, **No Disc** will be displayed and the disc will not be played correctly. (Refer to page 5 and clean the surface of the disc.) If the player encounters dirt or scratches while playing, video playback may be interrupted. (Some block-like patterns appear. When this occurs, your player will restore the image in 2~3 seconds.)

About Copyrights

- Any kind of unauthorized and commercial duplication, public performance, broadcasting, renting, copying and making transmittable of the content of discs is strictly prohibited by law.
- This product is equipped with anti-copy protection device and connecting to a VCR for recording purpose results in a distorted picture.
- This product incorporates copyright protection technology that is protected by method claims of certain U.S. patents and other intellectual property rights owned by Macrovision Corporation and other rights owners. Use of this copyright protection technology must be authorized by Macrovision Corporation, and is intended for home and other limited viewing uses only unless otherwise authorized by Macrovision Corporation. Reverse engineering or disassembly is prohibited.
- Manufactured under license from Dolby Laboratories. "Dolby", "Dolby Digital", "Dolby Pro Logic", and the double-D symbol () are trademarks of Dolby Laboratories.
- "DTS" is a trademark of Digital Theater System, Inc.

Description-Front Panel

Front View

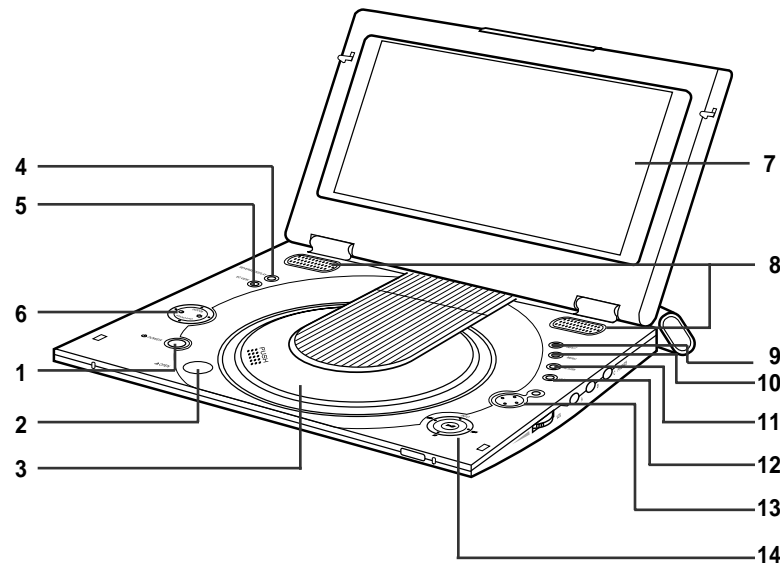

1. POWER
 - Press the POWER button for 1 second to power off.
2. OPEN
3. DISC COVER
4. REVERSE DISPLAY
5. EZ VIEW
6. AIC (Adaptive Image Control)
 - Standard : The basic mode for ordinary viewing.
 - Indoor : The best mode for partial lighting environment.
Displays a more vivid, detailed picture under artificial lighting conditions. with enhancement of signal components.
 - Outdoor : The perfect mode for sunny outdoor conditions.
☀ Increases the contrast and sharpness level to compensate for outdoor lighting conditions.
 - Low light : The optimum mode for low light viewing situations.
☾ If the viewing environment is very dark, use this mode to decrease brightness, and increase contrast and edge sharpness.
7. LCD
8. SPEAKER
9. INPUT
10. MENU
11. RETURN
12. CLEAR
13. ENTER (↵), DIRECTION (UP/DOWN/LEFT/RIGHT)
14. PLAY etc..
 - PLAY/PAUSE (▶|), INFO, STOP(■), REV-SKIP(◀◀), FWD-SKIP(▶▶)

Description-Front Panel

Right View

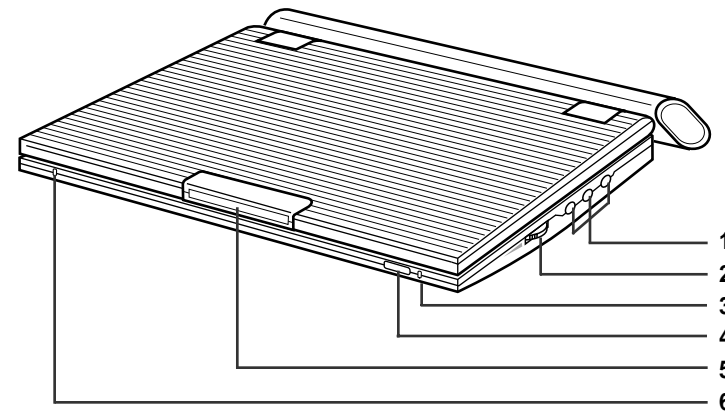

1. HEADPHONES A, B, C
2. VOLUME
3. CHARGING INDICATOR
4. REMOTE SENSOR
5. OPEN
6. STANDBY INDICATOR

Left View

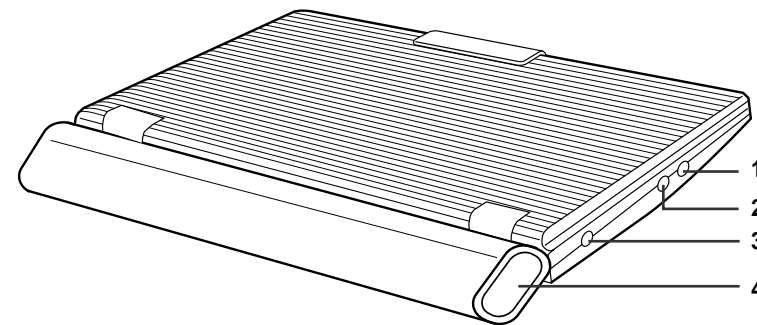

1. AUDIO IN/OUT / DIGITAL OUT
2. VIDEO IN/OUT / S-VIDEO OUT
3. DC IN 8.4V
4. BATTERY PACK

Description-Front Panel

Bottom View

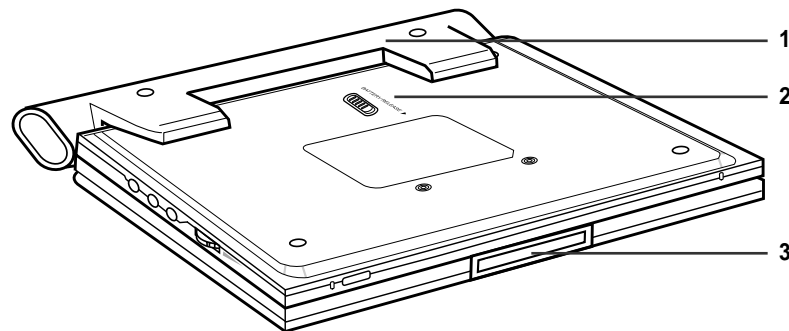

1. BATTERY PACK
2. RELEASE (Battery pack separation switch)
3. OPEN

Battery pack separation method

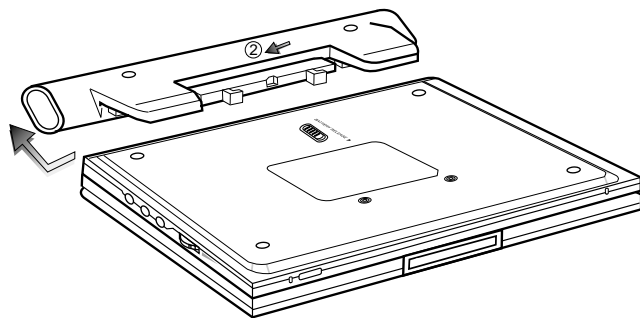

- ① Press in the direction of the arrow.
- ② Slide battery pack to the left, then out.

Tour of the Remote Control

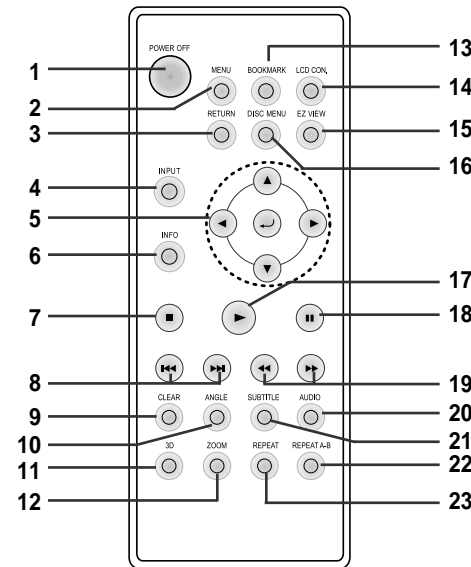

1. **DVD POWER OFF Button**
 - When you power off the unit with the remote, it remains in low power consumption mode. To turn the unit on, you must press the main POWER button on the unit.
2. **MENU Button**
 - Brings up the DVD player's setup menu.
3. **RETURN Button**
 - Returns to the previous menu.
4. **INPUT Button**
 - Use to select signal from external sources.
5. **ENTER/DIRECTION Buttons** (UP/DOWN or LEFT/RIGHT buttons)
 - This button functions as a toggle switch.
6. **INFO Button**
 - Displays the current disc mode.
7. **STOP Button**
 - Stops disc play
8. **SKIP Buttons**
 - Use to skip the title, chapter, or track.
9. **CLEAR Button**
 - Use to remove menus or status displays from the screen.
10. **ANGLE Button**
 - Use to access various camera angles on a DVD.
11. **3D Button**
12. **ZOOM Button**
13. **BOOKMARK Button**
14. **LCD CON. Button**
 - Changes the LCD display status.
15. **EZ VIEW Button**
 - Easy View can convert Letter Box images to full screen viewing on your screen.
16. **DISC MENU Button**
 - Brings up the Disc menu.
17. **PLAY Button**
 - Starts disc play.
18. **PAUSE/STEP Button**
 - Pauses disc play.
19. **SEARCH Buttons**
 - Allows you to search forward/backward through a disc.
20. **AUDIO Button**
 - Use this button to access various audio functions on a disc.
21. **SUBTITLE Button**
22. **REPEAT A-B Button**
 - Use to mark a segment to repeat between A and B.
23. **REPEAT Button**
 - Allows you to repeat play a title, chapter, track, or disc.

Using the Remote Control Unit

Installing the Battery in the Remote

1. Remove the battery compartment in the direction of the arrow.
2. Place the lithium battery in the battery compartment and put the battery compartment cover back on the remote.
 - Match the polarities (+ and -) on the battery with the marks in the battery compartment. If the battery is inserted in the wrong direction, your remote control may not work correctly.

(Back of the remote control)

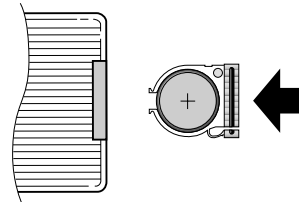
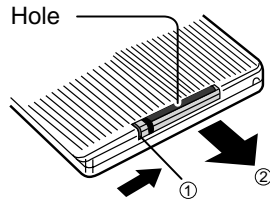

Operating Range of Remote Control Unit

Important!

Do not subject the remote control unit to strong vibration or shock. Keep the remote control unit free from moisture and water.

Caution

- After battery replacement, your remote control unit may not work. If this occurs, remove the battery and re-insert in about 5 minutes.
- It may be difficult to operate the remote control unit if the remote control sensor on the DVD player is exposed to direct sunlight or strong artificial light. Try operating the remote away from such light sources.
- Remove the battery when not planning to use the remote control unit for a long period of time.

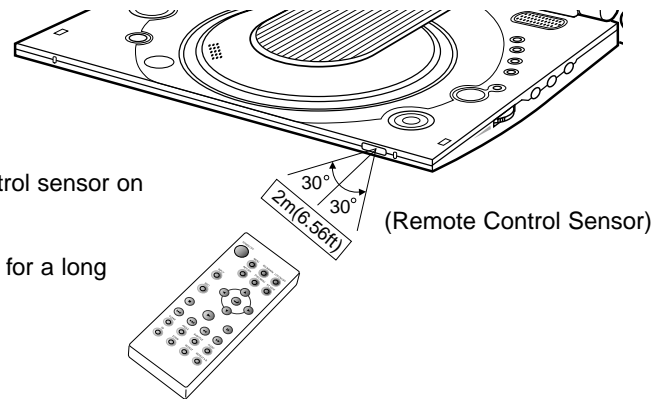

Connecting Headphones to the DVD

You can attach headphones with a stereo mini-jack plug to the PHONES jack for private listening. There are three jacks available.

How to use headphones

1. Insert headphones into the A, B or C PHONES jack.
 - This jack is a stereo mini-jack.

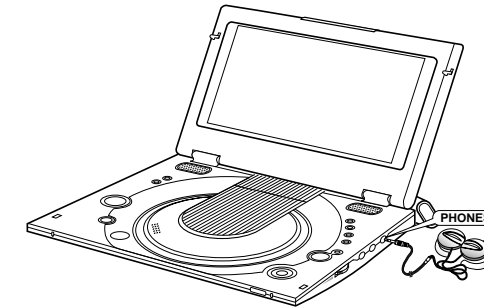

Important!

- Turn the headphone volume down to the minimum setting before connecting.

Caution

- Once you connect headphones to the DVD, your DVD Player's speakers will be disconnected.

2. Adjust the volume level by using the VOLUME control dial.

Connecting to an External Component (Input Select)

You can enjoy video from your VCR or Camcorder on your DVD player.

When connecting to an external component

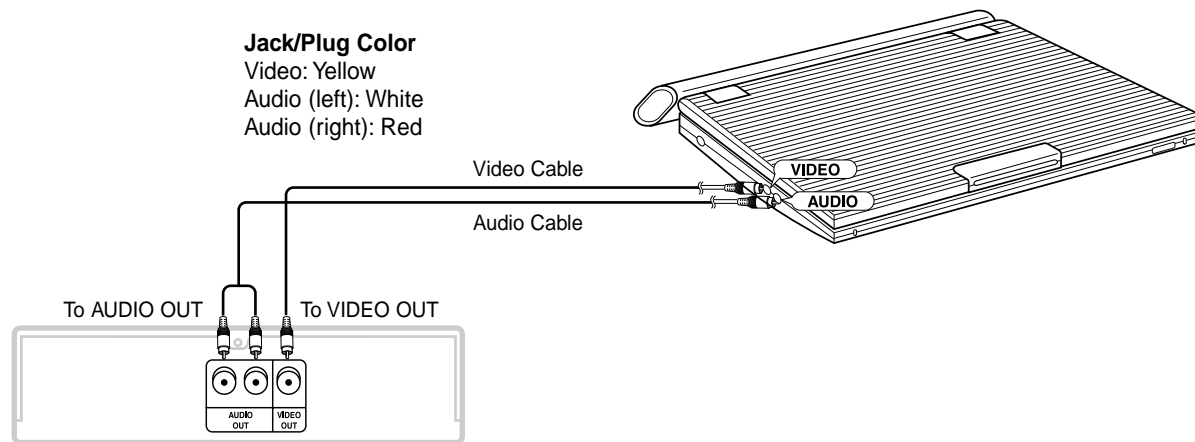

VCR or other component equipped with external output connectors

Important!

- Always turn off the DVD Player and other components before you connect any cables.
- Refer to owner's manual of the components you are connecting for more information on those particular components.

NOTE:

- In the INPUT mode, the video input must be the standard PAL or NTSC.

Viewing a Video from an External Component

Use the procedure below to view a video from a VCR or Camcorder on your DVD player.

To view a video from an external component

1. Connect the external component according to the procedure outlined on page 18.
2. Turn on the external component.
3. Turn on the DVD player.
4. Press the INPUT button to set the INPUT mode.
5. Press the PLAY button on the external component.

INPUT

Caution

- Power is not supplied from this device to the connected DVD player.
- When not using your DVD player, always remove all connecting cables from the video or audio input/output jacks.
- If no signal is input for more than 5 minutes while in the input mode, this unit enters the standby mode.

Connecting to a TV

You can enjoy high-resolution video using an S-VIDEO cable when connecting your DVD player to a TV equipped with an S-VIDEO input jack.

- Always turn off the DVD Player and TV before you connect any cables.

To view video with a TV

1. Turn on the TV.
2. Press the TV/VIDEO button on your TV to select the input from the DVD player.
3. Turn on the DVD player, and start playback.

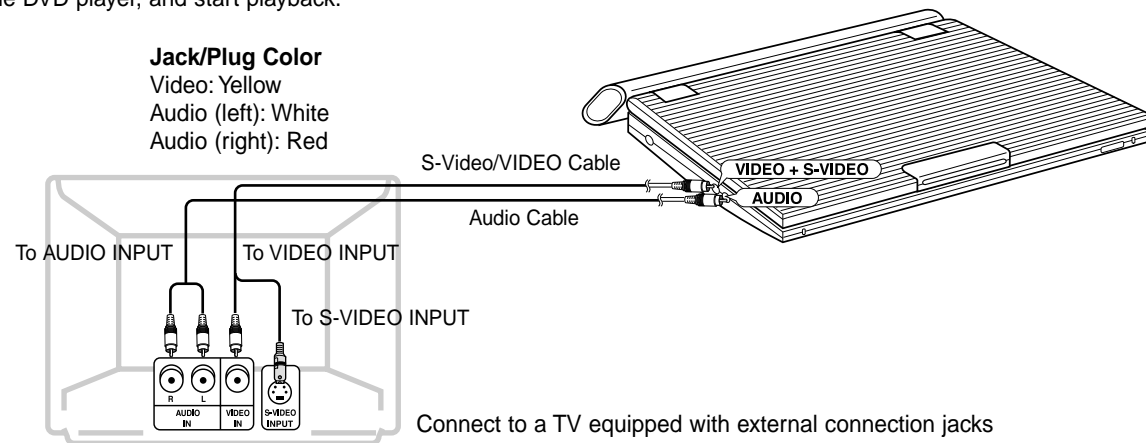

Caution

- If you wish to view video on your TV only, close the display panel of your DVD player. Playback will continue and audio to the speakers will be cut off, but you still will be able to use the remote to control the DVD player.
- For power saving, press the LCD CON. button to power off the LCD display.

Connecting to a Stereo Component

When you connect the DVD player to an audio system, you can listen to higher quality sound.

2-CH Audio Playback

■ Analog Connection

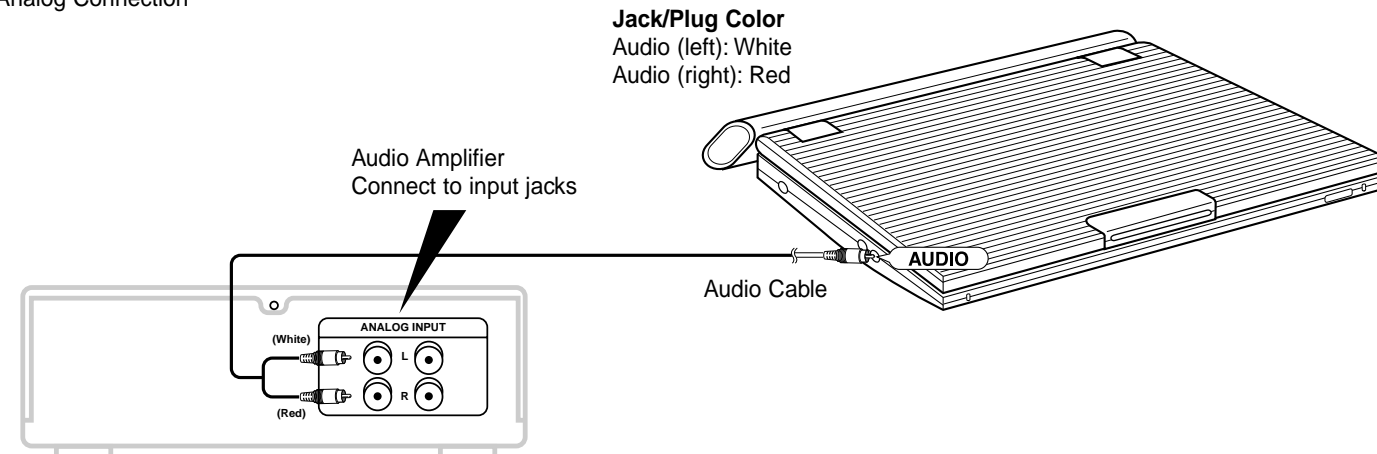

Connecting to a Stereo Component

Digital Audio Output (optical)

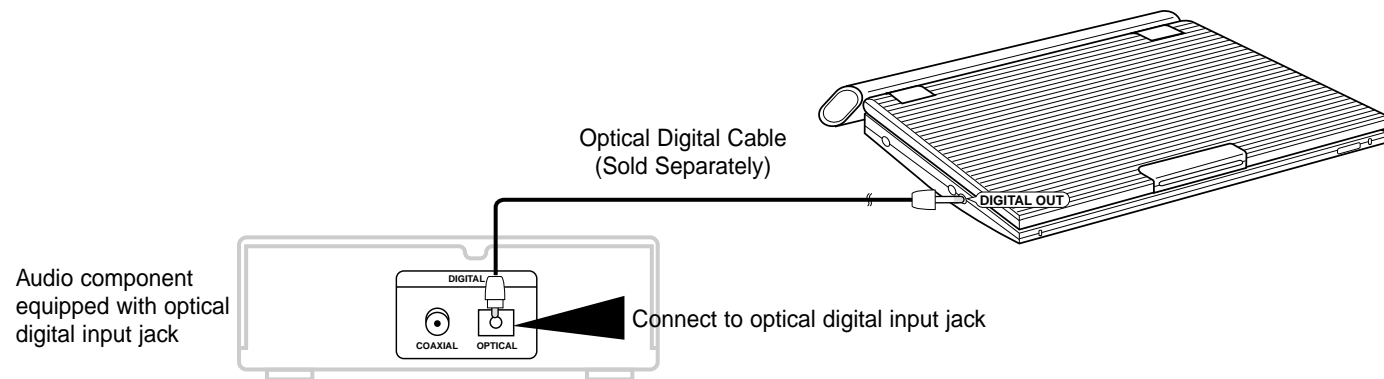

After the completion of above connections;

Set the "Dolby Digital Out" to "PCM" (see page 52) in "Audio Setup".

■ Digital connection to audio component without Dolby Digital decoder

- Audio CD
Play the disc.
When connecting digitally, DTS-encoded audio tracks will produce distorted sound.
- DVD Disc
When playing a Linear PCM Audio encoded disc, you must use the digital connection method shown above.

NOTE:

Only use an optical Digital Cable which has been designed for use with portable DVD.

Connecting to a Stereo Component

Playing Dolby Digital (5.1-CH) and DTS Audio

- You can enjoy full and dynamic surround sound by connecting a Dolby Digital/DTS digital surround processor or amplifier to the optical digital jack on the DVD player.
- When using DTS digital surround, select the DTS audio by using the disc menu screen or function adjustment screen.

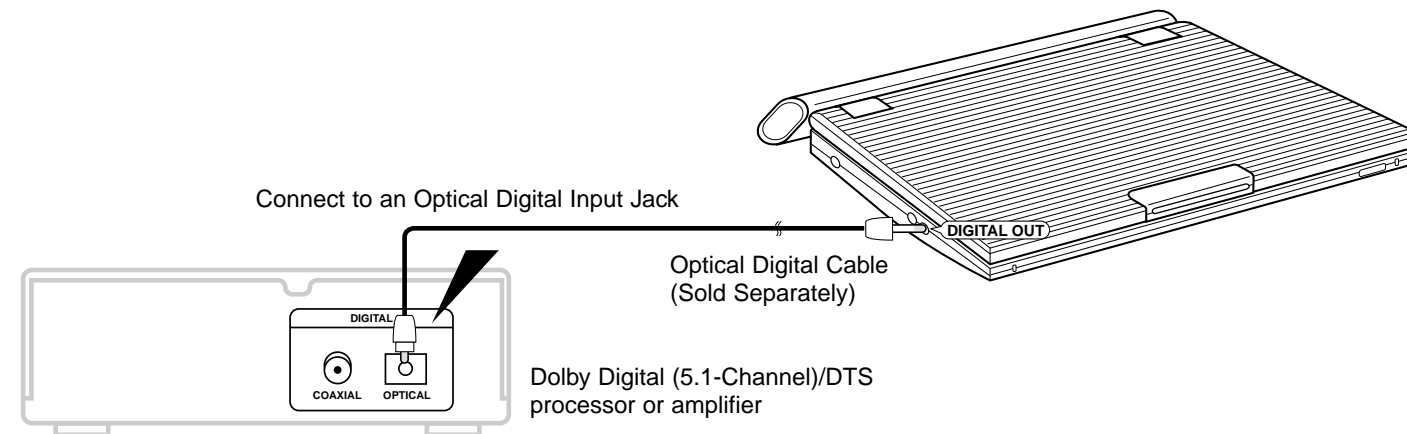

After making the connections shown above;

Set the "Dolby Digital Out" to "Bitstream" (see page 52) in "Audio Setup".

Caution

- To play a DTS disc, you need a DTS processor or amplifier.
- If the DTS processor or amplifier you want to use does not have an optical digital input jack, digital connection is not possible.
- Refer to owner's manual of the processor or amplifier for details on connections.

Using the AC adapter

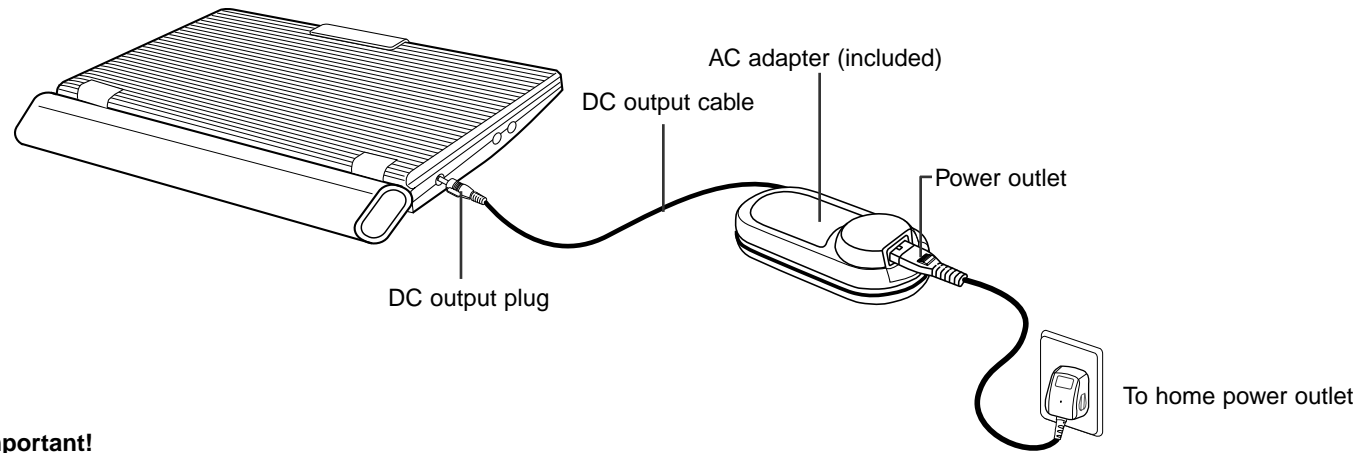

Important!

- Always turn off the DVD player before connecting or disconnecting the AC cord.
- Be sure to use the supplied AC adapter. Using a different type of adapter may cause malfunction or damage to the product.
- When the AC adapter is used for prolonged periods of time, the adapter may heat up. This is normal and is not a cause for concern.
- When not using the adapter, unplug it from the wall outlet.
- Keep the AC adapter free from moisture, cold, and dust. Otherwise, this can result in a risk of fire or electric shock.

Warning

- Only use the AC adapter supplied with this player.
- Be sure to unwind the AC adapter cable (DC output cable) before using, as electromagnetic interference may cause problems with other devices.

Using the AC adapter

Important!

- Always turn off the DVD player when inserting or removing the AC adapter.
- Before storing the battery pack, make sure it is completely drained.
Be sure to recharge the battery at least once every six months to ensure proper battery life.

Caution

- When charging or using the battery pack, it heats up.
This is normal and is not a cause for concern.

NOTE:

Connecting the battery pack to the AC Adapter;

- You can recharge the battery pack in the DVD player by turning off the player and connecting the AC adapter to the player.

Charge Time: Approx. 6.5 hours

- Charge time may be longer when using the battery pack in a cold environment.

DVD Continuous Playing Time with a Fully charged Battery pack (with speaker): Approx. 4.5 hours

- DVD continuous playing time is a reference indicating the maximum playing time at average speaker volume.
- The playback time may be shortened depending on the disc, surrounding temperature, battery pack conditions, and speaker volume.

Using the battery pack

Important!

- When inserting the battery pack, make sure that it is inserted correctly. Otherwise, your DVD player may malfunction.

Charging the battery pack

Use the AC adapter (included) to charge the battery pack.

- Before charging, make sure that the battery pack is correctly seated.

1. Connect the AC cord to the jack on the AC adapter (①).
2. Connect the DC cord to the DC IN jack on the left side of the DVD player (②).
3. Plug the other end of the AC cord into an AC outlet (③).

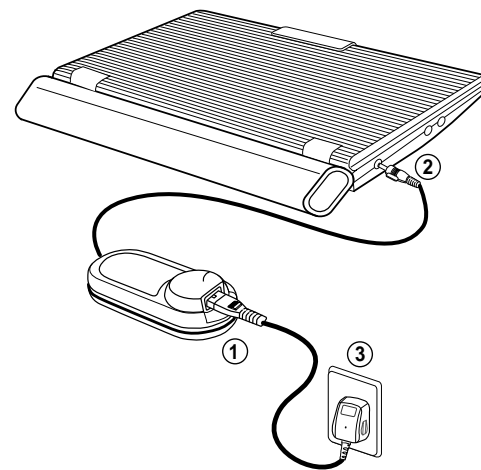

Blinking time	Charging rate
Once per second	Less than 50%
Twice per second	50%~75%
Three times per second	75%~90%
Blinking stops and stays on	90%~100%
On for a second and off for a second	Error-Reset the battery pack and the DC cable

Power Charge Lamp

-Green light will flash while charging.

-When the battery pack is fully charged, the light will stop blinking and remains green.

Battery level display

- The battery level display indicates the amount of power remaining in the battery pack.

- a. Fully charged
- b. 20~40% used
- c. 40~80% used
- d. Completely used (flickers)
(If the battery mark flickers the DVD will turn off soon. Change the battery as soon as possible)

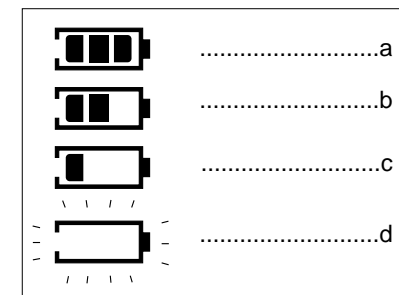

*The playing time is affected by environmental temperature and conditions.

The playing time becomes very short in a cold environment. The continuous playing times in the operating instructions are measured using a fully charged battery pack at 25°C. As the environmental temperature and conditions may differ when you actually use the DVD, the remaining battery time may not be the same as the approximate continuous playing times given in these instructions.

NOTE:

- When the operation time is noticeably shorter than normal, it is time to buy a new battery. The battery level display time changes depending on the battery operating time.
- As the battery is completely used, the noise screen intermittently can be displayed.

Playing a Disc

Before Play

After plugging in the player, the first time you press the POWER button, this screen comes up: Press the UP/DOWN buttons to select the language, and then press the ENTER button. (This screen will only appear the very first time you plug in the player.)



Play

1. Press the OPEN button to open the disc lid.
 - The disc lid opens up to around a 60-degree angle. Do not attempt to open the lid to an angle beyond this range. The lid may become damaged.

2. Place a disc gently into the tray.
 - You should hear and feel the disc snap firmly into place.

Caution

- Place a disc into the tray with the disc's label facing up.

3. Close the disc lid and then press the part marked "PUSH" until it clicks shut.

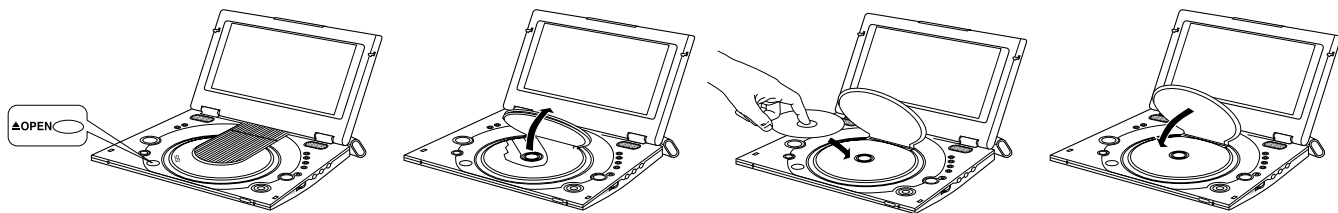

4. Stopping Play
 - Press the STOP (■) button during play.

5. Pausing Play
 - Press the PAUSE (||) button on the remote during play.
 - Screen stops, no sound.
 - To resume, press PLAY (▶) button once again.

Playing a Disc

6. Step Motion Play (Except CD)
 - Press the PAUSE (||)/STEP button on the remote during play.
 - Each time the button is pressed, a new frame will appear.
 - No sound is heard during STEP mode.
 - Press PLAY (▶) to resume normal play. (You can only perform step motion play in the forward direction.)

7. Slow Motion Play (Except CD)
 - Press the ⏪ button on the remote during PAUSE or STEP mode. By pressing the ⏪ button, you can select slow motion play for 1/8, 1/4 or 1/2 of normal speed.
 - Press and hold the ⏪ button to choose the play speed between 1/8, 1/4 and 1/2 of normal during PAUSE or STEP mode.
 - No sound is heard during slow mode.
 - Press PLAY (▶) to resume normal play.

NOTE: Reverse slow motion play will not work.

RESUME function

When you stop disc play, the player remembers where you stopped, so when you press PLAY (▶) again, it will pick up where you left off. (unless the disc is removed or the player is unplugged, or if you pressed the STOP (■) button twice.)

Important!

- Make sure that the disc is correctly placed. Otherwise, the disc and/or the DVD player may be damaged.
- If the disc is placed upside down in the disc tray or the region number of the DVD is not supported, No Disc will appear on the screen.

NOTE:

- If the player is left for 5 minutes in pause mode, it will stop.
- If the player is left in the stop mode for more than one minute without any user interaction, a screen saver will be activated. Screen saver will be activated only with a TV. Press the PLAY (▶) button to resume normal play.
- If the player is left in the stop mode for more than 5 minutes, the power will automatically shut off. (Automatic Power-Off Function)
- This ⓪ icon indicates an invalid button press.
- Do not remove the disc until it has completely stopped.
- Press the POWER button for 1 second to power off.

Using the Search & Skip Functions

During play, you can search quickly through a chapter or track or use the skip function to jump to the next selection.

Searching through a Chapter or Track

During play, press the SEARCH (◀◀ or ▶▶) button on the remote.

- Press the SEARCH (◀◀ or ▶▶) button on the remote for more than 1 second and press again or press continuously to search at a faster speed on the DVD, VCD, CD.
- Press the SKIP (◀◀◀ or ▶▶▶) button for more than 2 seconds to use the SEARCH feature.

DVD	2X, 4X, 8X, 16X, 32X, 128X
VCD	4X, 8X
CD	2X, 4X, 8X

Skipping Tracks

During play, press the NEXT SKIP (▶▶) or BACK SKIP (◀◀) button.

- When playing a DVD, if you press the NEXT SKIP button, it moves to the next chapter. If you press the BACK SKIP button, it moves to the beginning of the chapter. One more press makes it move to the beginning of the previous chapter.
- When playing VCD or a CD, if you press the NEXT SKIP button, it moves to the next track. If you press the BACK SKIP button, it moves to the beginning of the track. One more press makes it move to the beginning of the previous track.
- If a track exceeds 15 minutes when playing a VCD and you press the NEXT SKIP button, it moves forward 5 minutes. If you press the BACK SKIP button, it moves backward 5 minutes.

Using the Display Function

When Playing a DVD/VCD/CD

1. Press the INFO button during playback.
2. Use the UP/DOWN buttons to select the desired item.
3. Use the LEFT/RIGHT buttons to make the desired setup, then press ENTER.
4. To make the screen disappear, press the INFO button again.

 **Title** To access the desired title when there is more than one in the disc. For example, if there is more than one movie on a DVD, each movie will be identified

 **Chapter** Most of DVD discs are recorded in chapters so that you can quickly find a specific passage. (similar to tracks on an audio CD).

 **Time** Allows playback of the film from a desired time. You must enter the starting time as a reference.

 **Audio** Refers to the language of the film soundtrack. In the example, the soundtrack is played in English 5.1CH. A DVD disc can have up to eight different soundtracks.

 **Subtitle** Refers to the subtitle languages available in the disc. You will be able to choose the subtitle languages or, if you prefer, turn them off from the screen. A DVD disc can have up to 32 different subtitles.

 **3D Sound** A surround sound effect is generated using only two front speakers.

NOTE:

- If you want to see the battery level display, press the INFO button.

DVD



VCD

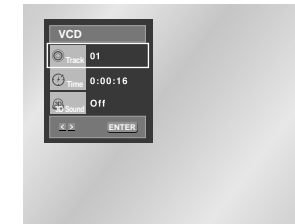

CD

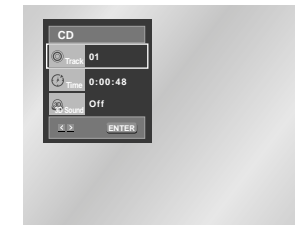

Using the Disc and Title Menu

Using the Disc Menu

1. Press the MENU button during playback.
2. Select **Disc Menu** using the UP/DOWN buttons, then press the RIGHT or ENTER button.



Using the Title Menu

1. Press the MENU button during playback.
2. Select **Title Menu** using the UP/DOWN buttons, then press the RIGHT or ENTER button.



NOTE:

- Depending on the disc, the Title and Disc Menus may not work.
- Title Menu will only be displayed if there are at least two titles in the disc.
- You can also use the Disc Menu, using the DISC MENU button on the remote.

Using the Function Menu

Using the Function Menu

1. Press the MENU button during playback.
2. Use the UP/DOWN buttons to highlight Function, then press the RIGHT or ENTER button.
3. Function selection screen appears, Info, Zoom, Bookmark, Repeat and EZ View.
 - Info (See Page 31)
 - Zoom (See Page 42)
 - Bookmark (See Page 41)
 - Repeat (See Page 34)
 - EZ View (See Page 36~37)
4. Use the UP/DOWN button to highlight one of the 5 functions. Then press the RIGHT or ENTER button to access the function.

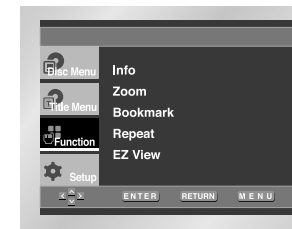

NOTE:

- You can also directly select the parts of these functions using their respective buttons on the remote.

Repeat Play

Repeat the current track, chapter, title, a chosen section (A-B), or all of the disc.

When playing a DVD

1. Press the REPEAT button on the remote. Repeat screen appears.
2. Select Chapter, Title or A-B using the LEFT/RIGHT buttons.

* REPEAT A-B

- Press the REPEAT button. Select A-B on screen with the LEFT/RIGHT buttons or press the REPEAT A-B button on the remote.
- Press ENTER at the point where you want the repeat play to start (A). The B is automatically highlighted.
- Press ENTER at the point where you want the repeat play to stop (B).
- To terminate the function, press the 'CLEAR' button or the 'REPEAT A-B' button again.
- A-B REPEAT does not allow you to set point (B) until at least 5 seconds has elapsed after point (A) has been set.

3. Press ENTER.

4. To return to normal play, press REPEAT again, then press the LEFT/RIGHT buttons to select Off. Press ENTER.

NOTE:

- DVD repeats play by chapter or title, CD and VCD repeats play by disc or track.
- Depending on the disc, the Repeat function may not work.

DVD

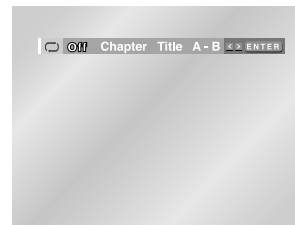

VCD/CD

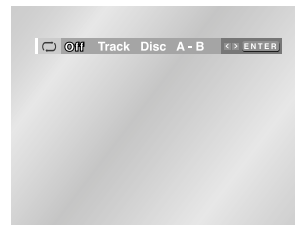

Slow Repeat play

This feature allows you slowly to repeat scenes containing sports, dancing, musical instruments being played etc. so you can study them more closely.

When playing a DVD

1. During play, press the PAUSE (II)/STEP button on the remote.
2. By pressing the ►► button, you can select slow motion play for 1/8, 1/4 or 1/2 of normal speed.
3. Press the REPEAT A-B button to select the point where the function starts. (A)
4. Press the REPEAT A-B button to select the point where the function ends. (B)

NOTE:

- The disc will play from A to B repeatedly at the speed you chose.
- To terminate the function, press the 'CLEAR' button or the 'REPEAT A-B' button again.
- A-B REPEAT does not allow you to set point (B) until at least 5 seconds has elapsed after point (A) has been set.

Adjusting the Aspect Ratio (EZ View)

To play back using aspect ratio (DVD)

Press the EZ VIEW button.

- The screen size changes when the button is pressed repeatedly.
- The screen zoom mode operates differently depending on the screen setting in the initial setup menu.
- To ensure correct operation of the EZ VIEW button, you should set the correct aspect ratio in the initial setup (See page 53).

If you are using a 16:9 TV

① For 16:9 aspect ratio discs

- **Wide Screen**
Displays the content of the DVD title in 16:9 aspect ratio.
- **Screen Fit**
The top and bottom of the screen are cut off. When playing a 2.35:1 aspect ratio disc, the black bars at the top and bottom of the screen will disappear. The picture will look vertically stretched. (Depending on the type of disc, the black bars may not disappear completely.)
- **Zoom Fit**
The top, bottom, left and right of the screen are cut off and the central portion of the screen is enlarged.

② For 4:3 aspect ratio discs

- **Normal Wide**
Displays the content of the DVD title in 16:9 aspect ratio. The picture will look horizontally stretched.
- **Screen Fit**
The top and bottom of the screen are cut off and the full screen appears. The picture will look vertically stretched.
- **Zoom Fit**
The top, bottom, left and right of the screen are cut off and the central portion of the screen is enlarged.
- **Vertical Fit**
When a 4:3 DVD is viewed on a 16:9 TV, black bars will appear at the left and right of the screen in order to prevent the picture from looking horizontally stretched.

Adjusting the Aspect Ratio (EZ View)

If you are using a 4:3 TV

① For 16:9 aspect ratio discs

- **4:3 Letter Box**
Displays the content of the DVD title in 16:9 aspect ratio. The black bars will appear at the top and bottom of the screen.
- **4:3 Pan Scan**
The left and right of the screen are cut off and displays the central portion of the 16:9 screen.
- **Screen Fit**
The top and bottom of the screen are cut off and the full screen appears. The picture will look vertically stretched.
- **Zoom Fit**
The top, bottom, left and right of the screen are cut off and the central portion of the screen is enlarged.

② For 4:3 aspect ratio discs

- **Normal Screen**
Displays the content of the DVD title in 4:3 aspect ratio.
- **Screen Fit**
The top and bottom of the screen are cut off and the full screen appears. The picture would look vertically stretched.
- **Zoom Fit**
The top, bottom, left and right of the screen are cut off and the central portion of the screen is enlarged.

NOTE:

- This function may behave differently depending on the type of disc.

Selecting the Audio Language

You can select a desired language quickly and easily with the AUDIO button.

Using the Audio button

1. Press the AUDIO button.
2. Use the LEFT/RIGHT buttons to select the desired language on a DVD.
 - The audio languages are represented by abbreviations.
3. Use the LEFT/RIGHT buttons to select Stereo, RIGHT or LEFT. (On VCD/CD)

DVD

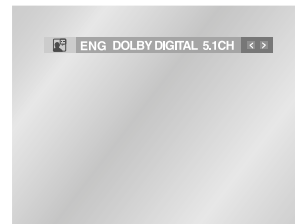

VCD/CD

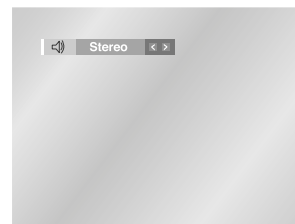

NOTE:

- This function depends on what languages are encoded on the disc and may not work with all DVDs.
- A DVD disc can contain up to 8 audio languages.
- **How to have the same audio language come up whenever you play a DVD;** Refer to "Setting Up the Language Features" on page 51.

Selecting the Subtitle Language

You can select a desired subtitle quickly and easily with the SUBTITLE button.

Using the SUBTITLE button

1. Press the SUBTITLE button.
2. Use the LEFT/RIGHT buttons to select the desired subtitle language.
3. Use the UP/DOWN buttons to determine whether or not the subtitle will be displayed.
 - Initially, the subtitle will not appear on screen.
 - The subtitle languages are represented by abbreviations.

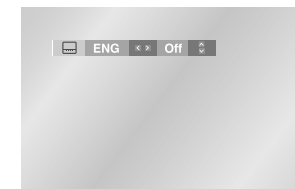

NOTE:

- This function depends on what languages are encoded on the disc and may not work with all DVDs.
- A DVD disc can contain up to 32 subtitle languages.
- **How to have the same subtitle language come up whenever you play a DVD;** Refer to "Setting Up the Language Features" on page 51.

Changing the Camera Angle

When a DVD contains multiple angles of a particular scene, you can select the Angle function.

Using the ANGLE button

Press the ANGLE button to see if an ANGLE () mark is present at the upper left hand corner of the screen.

1. When an ANGLE mark is shown, press the ANGLE button, then an ANGLE select icon will appear at the upper left hand corner of the screen.
2. Use the LEFT/RIGHT buttons to select the desired screen angle.
3. To turn off the display, press the ANGLE button again.



Using the Bookmark Function

The Bookmark function lets you select parts of a DVD or VCD so that you can quickly find the section at a later time.

Using the Bookmark Function (DVD/VCD)

1. During play, press the BOOKMARK button on the remote.
The Bookmark icons will be displayed.
2. Use the LEFT/RIGHT buttons to move to the desired bookmark icon.
3. When you reach the scene you want to mark, press the ENTER button.
The icon will change to a number (1, 2, or 3).
4. Press the BOOKMARK button to turn off the display.



Recalling a Marked Scene

1. During play, press the BOOKMARK button on the remote.
2. Use the LEFT/RIGHT buttons to select a marked scene.
3. Press the PLAY () button to skip to the marked scene.

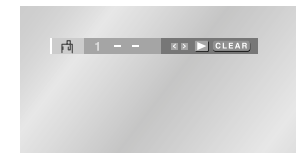

Clearing a Bookmark

1. During play, press the BOOKMARK button on the remote.
2. Use the LEFT/RIGHT buttons to select the bookmark number you want to delete.
3. Press the CLEAR button to delete a bookmark number.
Press the BOOKMARK button to turn off display.

NOTE:

- Up to three scenes may be marked at a time.
- Depending on the disc, the Bookmark function may not work.

Using the Zoom & 3D Sound Functions

Using the Zoom Function (DVD/VCD)

1. During play or pause mode, press the ZOOM button on the remote.
A square will be displayed on screen.
2. Use the UP/DOWN or LEFT/RIGHT button to select the part of the screen you want to zoom in on.
3. Press the ENTER button.
 - Press ENTER to zoom in 2X/4X/2X/Normal in order.(DVD)
 - Press ENTER to zoom in 2X/Normal in order.(VCD)

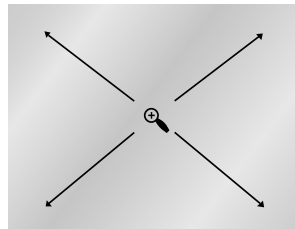

Using the 3D Sound Function

The simulated surround effect depends on the disc contents. If you connect the unit to your stereo system, you can enhance sound quality and produce a greater surround effect. This feature is useful when you are using the DVD player with a two channel stereo through the analog outputs.
(Discs which are recorded with LPCM or DTS will not work.)

1. During play, press the 3D button. The 3D SOUND mark will be displayed on screen.
2. Press the UP/DOWN buttons to turn the 3D Sound feature on or off.

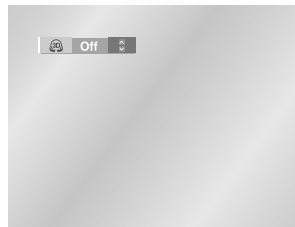

NOTE:

- 3D Sound is possible only on discs recorded using DOLBY SURROUND or DOLBY DIGITAL. However, some of these discs do not contain rear channel sound signals.
- Depending on the disc, the Zoom and 3D Sound function may not work.

Clips Menu for MP3/WMA/JPEG

1. Open the disc cover.
2. Place the disc in the player.
 - Place the disc with the labeled side up.
3. Close the cover.
 - The cover is closed and you should get a screen that looks like the one below.

- : File name of currently playing.
- : Current Playback Time.
- : Current Playback Mode : There are 4 modes, toggle by the REPEAT button.
 - Off : Normal Playback
 - Track : Repeat the current track.
 - Folder : Repeat the current folder.
 - Random : Files in the disc will be played in random order.
- : MP3 file icon.
- : JPEG file icon.
- : WMA file icon.
- : Folder icon.
- : Current Folder icon.



Parent Folder, Current Folder
and Peer Folders

Folders and Files
in Current Folder

Folder Selection

The folder can only be selected in the Stop mode.

- To select the Parent Folder
Press the RETURN button to go to Parent folder, or use the UP/DOWN buttons to select “..” and press ENTER to go to the parent folder.
- To select the Peer Folder
Use the LEFT/RIGHT buttons to highlight left window.
Use the UP/DOWN buttons to select the desired folder, then press ENTER.
- To select the Sub-Folder
Use the LEFT/RIGHT buttons to highlight right window.
Use the UP/DOWN buttons to select the desired folder, then press ENTER.

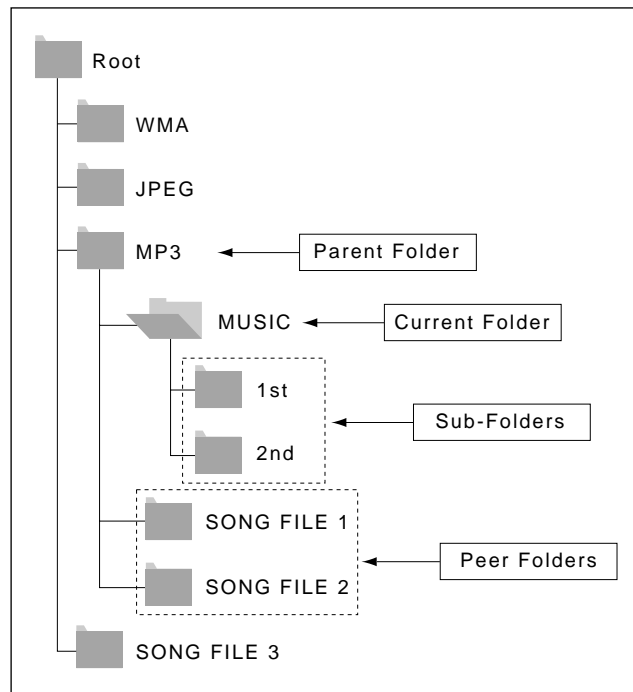

MP3/WMA Play

1. Open the disc cover.
2. Place the disc in the player.
- Place the disc with the labeled side up.
3. Close the cover.
- The cover is closed and you should get a screen that looks like the one below.

MP3/WMA Play Function

1. Select the desired folder. (See page 44 to change folder.)
2. Use the UP/DOWN buttons to select a song file.
3. Press ENTER to begin playback of the song file.



Repeat/Random playback

Press the REPEAT button to change playback mode.

There are 4 modes, Off, Track, Folder and Random.

- Off : Normal Playback
- Track : Repeats the current song file.
- Folder : Repeats the song files which have the same extension in the current folder.
- Random : Song files which have the same extension in disc will be played in random order.

* To resume normal play, press the CLEAR button.

MP3/WMA Play

CD-R MP3/WMA discs





When playing CD-R/MP3 or WMA discs, please follow all the recommendations for CD-R above, plus the comments below:

- **Your MP3 or WMA files should be ISO 9660 or JOLIET format.**
ISO 9660 format and Joliet MP3 or WMA files are compatible with Microsoft's DOS and Windows, and with Apple's Mac. These two formats are the most widely used.
- **When naming your MP3 or WMA files do not exceed 8 characters, and place ".mp3, .wma" as the file extension.**
General name format of: Title.mp3. or Title.wma. When composing your title, make sure that you use 8 characters or less, have no spaces in the name, and avoid the use of special characters including: (.,/, \, =, +).
- **Use a decompression transfer rate of at least 128 Kbps when recording MP3 files.**
Sound quality with MP3 files basically depends on the rate of compression/decompression you choose. Getting audio CD quality sound requires an analog/digital sampling rate, that is conversion to MP3 format, of at least 128 Kbps and up to 160 Kbps. However, choosing higher rates, like 192 Kbps or more, only rarely give better sound quality. Conversely, files with decompression rates below 128 Kbps will not be played properly.
- **Use a decompression transfer rate of at least 64Kbps when recording WMA files.**
Sound quality with WMA files basically depends on the rate of compression/decompression you choose. Getting audio CD quality sound requires an analog/digital sampling rate, that is conversion to WMA format, of at least 64Kbps and up to 192Kbps. Conversely, files with decompression rates below 64Kbps or over 192Kbps will not be played properly.
- **Do not try recording copyright protected MP3 files.**
Certain "secured" files are encrypted and code protected to prevent illegal copying. These files are of the following types: Windows Media™ (registered trade mark of Microsoft Inc) and SDMI™ (registered trade mark of The SDMI Foundation). You cannot copy such files.
- **Important:** The above recommendations cannot be taken as a guarantee that the DVD player will play MP3 recordings, or as an assurance of sound quality. You should note that certain technologies and methods for MP3 file recording on CD-Rs prevent optimal playback of these files on your DVD player (degraded sound quality and in some cases, inability of the player to read the files).
- This unit can play a maximum of 3000 files and 300 folders per disc.



Picture CD Playback

1. Select the desired folder. (See page 44 to select the folder)
2. Use the UP/DOWN buttons to select a Picture file in clip menu and you should get a screen that looks like the one below.

- Select JPEG in the menu to view a Photo CD.
- Use the UP/DOWN or LEFT/RIGHT buttons on the remote control to select the picture you want to view and then press the ENTER button. (Press the PLAY (▶) button if you want to play it in the Slide Show mode.)
- To see the next 6 pictures, press the ►► button.
- To see the previous 6 pictures, press the ◀◀ button.

-  : Return to the Album Screen.
Press the UP/DOWN or LEFT/RIGHT buttons on the remote control to display the menu again.
-  : Each time the ENTER button is pressed, the picture rotates 90 degrees clockwise.
-  : Each time the ENTER button is pressed, the picture is enlarged up to 2X. (Normal → 2X → Normal)
-  : The unit enters slide show mode.

*Before the Slide Show begin, the picture interval must be set.

-  : When this icon is selected and ENTER is pressed, the pictures change automatically with about 6 seconds interval.
-  : The pictures change automatically with about 12 seconds interval.
-  : The pictures change automatically with about 18 seconds interval.

- *Depending on the file size, each interval between images may take longer or shorter than the manual suggests.
- If no button on the remote control is pressed for 60 seconds, the menu will disappear and the selected item will be played.

NOTE:

- If no buttons on the remote control are pressed for 10 seconds, the menu will disappear.
Press the UP/DOWN or LEFT/RIGHT buttons on the remote control to display the menu again.
- Press the STOP button to return to the clips menu.
- When playing a Kodak Picture CD, the unit displays the Photo directly, not the clip menu.

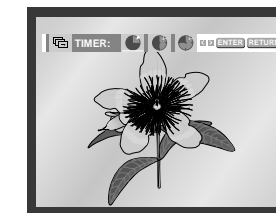
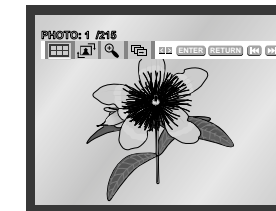

Picture CD Playback

CD-R JPEG Discs

- Only files with the ".jpg" and ".JPG" extensions can be played.
- Only CD-R discs with JPEG files in ISO 9660 or Joliet format can be played.
- The name of the JPEG file may not be longer than 8 characters and should contain no blank spaces or special characters (. / = +).
- Only a consecutively written multisession disc can be played.
 - If there is a blank segment in the multisession disc, the disc can be played only up to the blank segment.
- A maximum of 500 images can be stored on a single CD.
- When playing a Kodak Picture CD, only the JPEG files in the pictures folder can be played.
- Kodak Picture CD : The JPEG files in the pictures folder can be played automatically.
- Konica Picture CD : If you want to see the Picture, select the JPEG files in the clips menu.
- Fuji Picture CD : If you want to see the Picture, select the JPEG files in the clips menu.
- QSS Picture CD : The unit cannot play QSS Picture CD.
- If a number of files in 1 Disc are over 3000, only 3000 JPEG file can be played.
- If a number of folders in 1 Disc are over 300, only JPEG files in 300 folders can be played.

Using the Setup Menu

The Setup menu lets you customize your DVD player by allowing you to select various language preferences, set up a parental level, even adjust the player to the type of television screen you have.

1. With the unit in Stop mode, press the MENU button.
Select **Setup** using UP/DOWN buttons, then press the RIGHT or ENTER button.

- ➊ **Language Setup** : Setup of the Language.
- ➋ **Audio Setup** : Setup of the Audio Options
- ➌ **Display Setup** : Setup of the Display Options
Use to select which type of screen you want to watch and several display options.
- ➍ **Parental Setup** : Setup of the Parental Level
Allows users to set the level necessary to prevent children from viewing unsuitable movies such as those with violence, adult subject matter, etc.

2. Use the UP/DOWN buttons on the remote to access the different features.

3. Press the ENTER button to access the sub features.

To make the setup screen disappear after setting up, press the MENU button again.



NOTE:

- **How to make the Setup menu disappear or return to menu screen during set up;**
Press RETURN or LEFT button.
- Depending on the disc, some Setup Menu selections may not work.

Setting Up the Language Features

If you set the player menu, disc menu, audio and subtitle language in advance, they will come up automatically every time you watch a movie.

Using the Player Menu Language

1. With the unit in Stop mode, press the MENU button.
2. Select **Setup** using UP/DOWN buttons, then RIGHT or ENTER button.
3. Select **Language Setup** using UP/DOWN buttons, then press the RIGHT or ENTER button.
4. Select **Player Menu** using UP/DOWN buttons, then press the RIGHT or ENTER button.
5. Use the UP/DOWN buttons to select '**English**'.
6. Press the ENTER button.
 - English is selected and the screen returns to Setup menu.
 - To make the Setup menu disappear, press the RETURN or LEFT button.



Using the Disc Menu Language

This function changes the text language only on the disc menu screens.

1. With the unit in Stop mode, press the MENU button.
2. Select **Setup** using UP/DOWN buttons, then RIGHT or ENTER button.
3. Select **Language Setup** using UP/DOWN buttons, then press the RIGHT or ENTER button.
4. Select **Disc Menu** using UP/DOWN buttons, then press the RIGHT or ENTER button.
5. Use the UP/DOWN buttons to select '**English**'.
 - Select "Others" if the language you want is not listed.
6. Press the ENTER button.
 - English is selected and the screen returns to Setup menu.



Setting Up the Language Features

Using the Audio Language

1. With the unit in Stop mode, press the MENU button.
2. Select **Setup** using UP/DOWN buttons, then RIGHT or ENTER button.
3. Select **Language Setup** using UP/DOWN buttons, then press the RIGHT or ENTER button.
4. Select **Audio** using UP/DOWN buttons, then press the RIGHT or ENTER button.
5. Press the UP/DOWN buttons to select '**English**'.
 - Select "Original" if you want the default soundtrack language to be the original language the disc is recorded in.
 - Select "Others" if the language you want is not listed.
6. Press the ENTER button.
 - English is selected and the screen returns to Setup menu.



Using the Subtitle Language

1. With the unit in Stop mode, press the MENU button.
2. Select **Setup** using UP/DOWN buttons, then RIGHT or ENTER button.
3. Select **Language Setup** using UP/DOWN buttons, then press the RIGHT or ENTER button.
4. Select **Subtitle** using UP/DOWN buttons, then press the RIGHT or ENTER button.
5. Use the UP/DOWN buttons to select '**English**'.
 - Select "Automatic" if you want the subtitle language to be the same as the language selected as the audio preference.
 - Select "Others" if the language you want is not listed. Some discs may not contain the language you select as your initial language; in that case the disc will use its original language setting.
6. Press the ENTER button.
 - English is selected and the screen returns to Setup menu.



NOTE:

- If the selected language is not recorded on the disc, the original pre-recorded language is selected.
- **How to make the Setup menu disappear or return to menu screen during set up;** Press RETURN or LEFT button.

Setting Up the Audio Options

1. With the unit in Stop mode, press the MENU button.
2. Select **Setup** using UP/DOWN buttons, then RIGHT or ENTER button.
3. Select **Audio Setup** using UP/DOWN buttons, then press the RIGHT or ENTER button.
4. Use the UP/DOWN buttons to select the desired item. Then press the RIGHT or ENTER button.

1 Dolby Digital Out

1. PCM : Converts to PCM(2CH) audio. Select PCM when using the Analog Audio Outputs.
2. Bitstream : Converts to Dolby Digital Bitstream (5.1CH).
Select Bitstream when using the Digital Audio Output.

NOTE: Be sure to select the correct Digital Output or no audio will be heard.

2 MPEG-2 Digital Out

1. PCM : Converts to PCM(2CH) audio. Select PCM when using the Analog Audio Outputs.
2. Bitstream : Converts to MPEG-2 Digital Bitstream (5.1CH or 7.1CH).
Select Bitstream when using the Digital Audio Output.

3 DTS

1. Off : Doesn't output digital signal.
2. On : Outputs DTS Bitstream via digital output only.
Select DTS when connecting to a DTS Decoder.

4 Dynamic Compression

1. On : To select dynamic compression.
2. Off : To select the standard range.

NOTE:

- **How to make the Setup menu disappear or return to menu screen during set up;**
Press RETURN or LEFT button.
- Manufactured under license from Dolby Laboratories.
“Dolby” and the double-D symbol are trademarks of Dolby Laboratories.
- “DTS” and “DTS Digital Out” are trademarks of Digital Theater Systems, Inc.

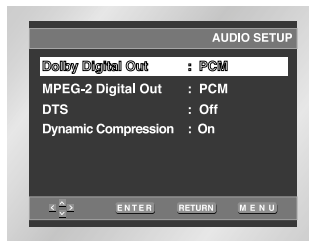
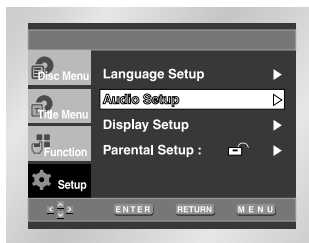

Setting Up the Display Options

1. With the unit in Stop mode, press the MENU button.
2. Select **Setup** using UP/DOWN buttons, then RIGHT or ENTER button.
3. Select **Display Setup** using UP/DOWN buttons, then press the RIGHT or ENTER button.
4. Use the UP/DOWN buttons to select the desired item. Then press the RIGHT or ENTER button.

1 TV Aspect

- Depending on the type of television you have, you may want to adjust the screen setting (aspect ratio).
1. 4:3 Letter Box :
Select when you want to see the total 16:9 ratio screen DVD supplies, even though you have a TV with a 4:3 ratio screen. Black bars will appear at the top and bottom of the screen.
 2. 4:3 Pan Scan :
Select this for conventional size TVs when you want to see the central portion of the 16:9 screen. (Extreme left and right side of movie picture will be cut off.)
 3. 16:9 Wide :
You can view the full 16:9 picture on your widescreen TV.

2 Still Mode

- These options will help prevent picture shake in still mode and display small text clearer.
1. Auto : When selecting Auto, Field/Frame mode will be automatically converted.
 2. Field : Select this feature when the screen shakes in the Auto mode.
 3. Frame : Select this feature when you want to see small letters more clearly in the Auto mode.

3 Screen Messages

Use to turn on-screen messages On or Off.

4 NTSC Disc Output

“NTSC” if the screen only has one NTSC-video entrance.
If this is not the case, you can choose to leave “PAL 60Hz” as is.

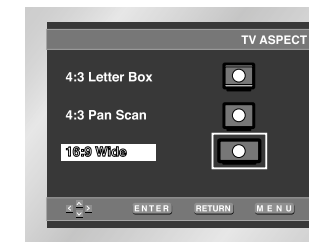
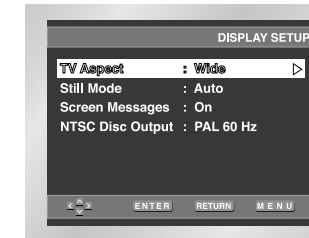
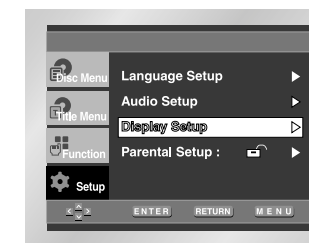

Setting Up the Parental Control

The Parental Control function works in conjunction with DVDs that have been assigned a Rating level which helps you control the types of DVDs that your family watches. There are up to 8 rating levels on a disc.

1. With the unit in Stop mode, press MENU button. The Setup Menu screen appears.
2. Select **Setup** using UP/DOWN buttons, then RIGHT or ENTER button.
3. Select **Parental Setup** using UP/DOWN buttons, then press the RIGHT or ENTER button.
4. Use RIGHT or ENTER to select **Yes** if you want to use a password. The **Enter Password** screen appears.
5. Enter your password with the UP/DOWN/LEFT/RIGHT buttons. The **Re-enter Password** screen appears to confirm the password. Enter your password again. The Parental Control screen appears.

About the Rating Level ;

The Rating Level will work only when **Use Password** is set to Yes. To unlock the player, use RIGHT or ENTER to select No. Use RIGHT or ENTER to select **Rating Level**. Press ENTER.

- Use UP/DOWN to select the level(e.g. Level 6) and press ENTER.
Discs that contain Level 7 will now not play.
- To cancel the rating level, use RIGHT or ENTER to select No in Use Password.

About the Change Password ;

- Use UP/DOWN to select Change Password.
Press ENTER. The Change Password screen appears.
- Enter your new password. Enter the new password again.

NOTE:

- **How to make the Setup menu disappear or return to menu screen during set up;**
Press RETURN or LEFT button.
- If you have forgotten your password, see Forgot Password in the Troubleshooting Guide.

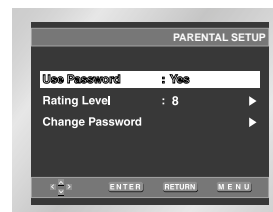
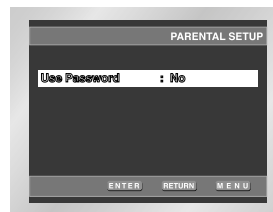
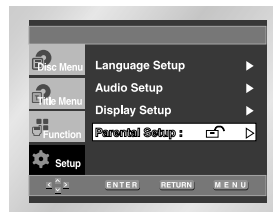

Cautionary Notes

Cautions on Using the Player

- **Avoid magnetic environments.**
Using the player under strong fluorescent lighting, in a car, near a TV or magnetic object may deteriorate recorded images.
- **Be sure to remove the disc, turn off the player, and remove the battery pack after use.**
- **If used near a broadcast station or power transmission tower, the video may become distorted due to interference.**
- **Do not drop the player or subject it to strong vibration or shock.**
- **Do not place the player near a lamp.**
Heat from the incandescent light bulbs may cause deformation or malfunction.
- **Always observe the rules regulating the use of electrical devices on airplanes.**
- **Do not expose this product to high temperature and humidity.**
This product can be operated within temperature range of 10°C~30°C and humidity range of 30%~80%. Do not expose this product to direct sunlight or in a car with its windows closed. Doing so may result in deformation of casing and circuitry as well as cause fire or bodily injury.
- **Do not let water, sand, dust, or other foreign objects in the player. Avoid using or storing the player in a place where there is smoke, steam, or moisture.**
Doing so may cause malfunction or mold on the pick-up lens. Keep the player in a well-ventilated area.
- **When using the player in cold environments, the color LCD screen may not be visible immediately after the power is turned on.**
This is not a malfunction. Do not operate the player in temperatures below 10°C.
- **Be especially careful not to scratch the pick-up lens during loading/unloading of the disc, or cleaning.**
Doing so may result in malfunction.

Cautionary Notes

When Moving the Player

- **Be sure to remove the disc from the player before packing for moving.**

It is recommended that you also remove the disc from the player and turn off the power when not using the player.

Saving Power

- **It is recommended that you turn off the power to the DVD player when not use.**

If you are not going to use it for prolonged period of time, unplug the power cord from the wall outlet.

Maintenance of LCD Screen

- **To keep the screen clean, turn off the power and then wipe with a soft cloth.**

About LCD Screen

- This LCD panel is designed with the latest technology ensuring 99.99% of active pixels.

Cautionary Notes

Cautions on Using Battery pack

Danger!

Always follow the safety information below when using the battery pack. Otherwise, a short circuit, overheating, smoke, fire, or damage to the product may result.

1. Never disassemble or modify the battery pack in any way. Do not touch the terminal of the battery pack with a metal object.
2. Do not let any metal object inside the battery pack.
3. Do not place the battery pack in direct sunlight, dashboard of a vehicle, or high temperature.
4. Do not expose the battery pack to water, fire, or heat.
5. Always use the included AC adapter when charging the battery pack.
6. This battery pack is designed exclusively for your portable DVD player. Do not use it with other devices.

Warning!

1. Do not drop or subject to strong vibration.
2. Keep out of reach of children.
3. The battery pack may leak fluid that is harmful to your eyes.
 - If this fluid gets in your eyes, wash eyes immediately with large amounts of running water and get medical attention immediately.
 - If the fluid gets on your skin or clothing, wash immediately with water.

Caution!

1. When not using the battery pack, remove it and store in a cool place.
2. Do not use the AC adapter or battery pack for a prolonged period of time during recharging. You might get a low temperature burn.
3. Keep the battery pack free from smoke, steam, moisture, and dust.
 - Do not place the battery pack near a kitchen, heater, or any other place where there is smoke or steam. Doing so may result in fire or electric shock.
 - Avoid direct sunlight, heater, or high temperature place. etc, inside of a car. It can cause explosion or fire. Doing so may cause a short circuit, overheating, smoke, fire, or damage to the product.
4. Using the battery pack under 10°C or over 30°C can cause reduced battery life.

Cautionary Notes

After a Recharge, Store the Battery pack Separately.

- This battery pack is a lithium ion battery. Even when not in use, power will drain slowly. So use a fully charged battery pack.
- Recharge until the charge lamp stays on green. A partial charging of the battery pack decreases the overall lifetime of the battery.

Cautions on Charging Battery pack

- Charge within the surrounding temperature range of 10°C~30°C. Charging at a low surrounding temperature slows down the charging time and decreases the battery pack. You cannot fully charge the battery pack at high temperature.
- If the DVD player is overheated and the battery pack's internal temperature goes up to a certain level, you will not be able to charge the battery pack. (The lamp flashes quickly and the light does not come on.)
In this case, remove the battery pack. After the internal temperature reaches a safe level, charging will begin automatically.
- The battery pack becomes warm during recharge or use. This is normal and is not a cause for concern.
A hot battery pack may take longer to charge or may not be charged at all. Wait until the battery pack cools down before charging.

Battery pack Life and Use (Low Temperature)

- The lifetime of the battery pack is limited.
Power is slowly drained even when not using. Though it varies for differing storage conditions, the battery pack stored unused for a year has a much shorter lifetime.
If the battery pack does not last long even after a full charge, you might have to replace it with a new one.
- Total operating time of the battery pack becomes much shorter when used at temperatures below 10°C.
Electrical energy is discharged due to internal chemical action of the battery pack.
A very low temperature may impede this chemical action and shortens the total operating time.

Caution

- Be sure to use only the battery pack exclusively designed for your DVD player.

NOTE:

- When not using the DVD player, always turn off the power to conserve the battery pack.
If the AC adapter is connected to the player, charge the battery pack with the power to the player turned off.

Cautionary Notes

Cautions on Storing Battery pack

- Even when not in use, power is consumed continuously. To reduce the power consumption, follow the procedure below.
 1. Remove the battery pack from the DVD player after every use.
 2. When not using the DVD player, turn off the power. If the player is left in the standby mode, power will be slowly drained from the battery pack and the charging capacity will decrease.
 3. Before storing the battery pack, completely drain the power by operating the player and store in a cool, dry place.
If stored in a hot place, the capacity of the battery pack will decrease.
 4. The battery pack must be recharged and then used on the DVD player at least once every 6 months.
This helps to prevent the loss of capacity.

AC Adapter

The supplied AC adapter is compatible with 50/60Hz electrical system (110V~240V range).
Use of the AC adapter depends on the specific voltage requirements and electrical outlet design.

- Using the AC adapter near a radio may cause poor reception.
- Do not let any type of flammables, liquid, or metal objects in the adapter.
- The adapter is covered with an outer plastic sheath. Do not peel open the sheath.
- Do not drop, jar, or shake the adapter.
- Do not place in direct sunlight.
- Do not use in high temperature or cold and humid environments.

Cleaning and Maintenance

- Many plastic parts are used in this DVD player casing. Do not use volatile chemicals such as benzene or thinner.
This might damage the finish.
- Wipe the casing with a soft, dry cloth. For excessive dirt, use a cloth dampened in a diluted neutral detergent. and wipe again with a soft, dry cloth.
- Wipe off fingerprints or dirt on the LCD screen using a soft, dry cloth.

Troubleshooting

If your DVD player does not seem to be functioning properly, check the items below before you contact a Samsung authorized service center.

Symptom	Check
Power does not turn on or suddenly turns off.	<ul style="list-style-type: none"> • Make sure the AC power cord is securely plugged into an AC outlet. • Turn the power off and then back on.
Battery pack is in place but the power does not turn on or suddenly turns off	<ul style="list-style-type: none"> • Check that the battery pack is charged. If not, recharge it.
Remote control won't work	<ul style="list-style-type: none"> • Check that the battery is inserted in the "+" and "-" direction properly. • The batteries may be dead. Replace them with new batteries. • Check that the signal transmission is directed at the remote control sensor on the DVD player. • Remove the obstacle between the remote control unit and remote control sensor.
No picture or sound	<ul style="list-style-type: none"> • Check that the video and audio cables are securely connected. • Check that the disc is a DVD (region number 1 or all), DVD-RW, VIDEO CD or AUDIO CD. • Do not use a disc that has scratches or dirt. • Check that the label-side of the disc is facing up. • The pick-up lens of the DVD player may be dirty. Contact the service center for lens cleaning. • Check that the TV channel is set to VIDEO or AV if viewing with a TV.
Forgot password	<ul style="list-style-type: none"> • Press power on from a cold start with no disc in the unit. Press the STOP and PLAY buttons simultaneously on the unit for three seconds. The Select Menu Language display will appear. Select the desired language by using UP or DOWN button. Press the MENU button on the remote control to select the Parental Mode. The Parental Mode is now unlocked as indicated on the display. Press the DOWN button to select Parental. Press ENTER and the Create Password display will appear. You can now set your rating level and change your password to a new number.

The built-in micro controller can be influenced by external electrical noise. If you believe this may be the cause of the problem, turn off the DVD player and then back on.

Troubleshooting

Symptom	Check
No picture	<ul style="list-style-type: none"> • Check that the LCD display is turned on.
No sound	<ul style="list-style-type: none"> • Check that the display panel is open. If it is closed, audio will not be output to the speakers. • Check the volume setting. If set to zero, turn up volume level. • Check that the headphones are plugged into the PHONES jack. Speakers cannot be used with the headphones.
No picture and sound	<ul style="list-style-type: none"> • Check that the DVD player is in the DVD mode and not in the INPUT mode.
Distorted video or sound	<ul style="list-style-type: none"> • Use a disc without scratches or dents.
While in the input mode, no picture is output from the external component to the DVD player	<ul style="list-style-type: none"> • Check that the video or audio cable is securely connected. • Make sure the S-Video cable is used for output only. • Check that the DVD player is in the INPUT mode and not in the DVD mode.

Troubleshooting

Symptom		Check
DVD	Video does not appear with a external component connected to the DVD player	<ul style="list-style-type: none"> • Check that the TV is set to VIDEO or AV. • Check that the video or audio cable is securely connected.
	Dolby Digital audio volume is too low	<ul style="list-style-type: none"> • Change the "Dynamic Compression" setting to "On". This will turn up the comparatively low volume level of Dolby Digital, which provides the most wide, dynamic sound range.
Battery pack operation	Battery pack won't charge	<ul style="list-style-type: none"> • Check that the DVD player is turned off. You cannot charge the battery pack with the player turned on. • A hot battery pack may take longer to charge. Wait until the battery pack is sufficiently cooled down.
	Power does not turn on	<ul style="list-style-type: none"> • Replace with a fully charged battery pack or use the AC adapter.
	Power charge lamp does not light (Battery pack won't charge)	<ul style="list-style-type: none"> • Replace with a fully charged battery pack or use the AC adapter. If the DVD player is overheated and the battery pack's internal temperature goes up to a certain level, you will not be able to charge the battery pack. In this occurs, remove the battery pack. After the battery pack has sufficiently cooled down, charging will begin automatically. • Check that the temperature is within the range of 10°C~30°C. • Check that the DC cord of the AC adapter is plugged in correctly.
	Power charge lamp quickly flashes Green	<ul style="list-style-type: none"> • Remove the DC cord from the battery pack and then re-plug. If the battery pack is installed, remove the DC cord from the battery pack before performing above procedure. • Recharge a different power pack. If the same symptom occurs, your AC adapter may be defective. If the second battery pack charges without any problem, your first battery pack may be defective or needs battery replacement.

Specifications

General	Power Requirements	AC 100~240V, 50/60 Hz
	Power Consumption	16 W
	Weight	1.5 Kg (without battery pack)
	Dimensions	301mm (W) x 29.5 mm (H) x 203mm (D)
	Operating Temperature Range	+5°C to +35°C
	Operating Humidity Range	10 % to 75 %
Disc	DVD (DIGITAL VERSATILE DISC)	Reading Speed : 3.49 m/sec. Approx. Play Time (Single Sided, Single Layer Disc) : 135 min.
	CD : 12Cm (COMPACT DISC)	Reading Speed : 1.2 to 1.4m/sec. Maximum Play Time : 74 min.
	CD : 8Cm (COMPACT DISC)	Reading Speed : 1.2 to 1.4m/sec. Maximum Play Time : 20 min.
	VCD : 12Cm	Reading Speed : 1.2 to 1.4m/sec. Maximum Play Time : 74 min. (Video + Audio)
Video Output	Composite Video	1 channel : 1.0 Vp-p (75 Ω load)
	S-VIDEO	Luminance Signal : 1.0 Vp-p (75 Ω load) Chrominance Signal : 0.286 Vp-p (75 Ω load)
Audio Output	2 channel	L(1/L), R(2/R)
	*Frequency Response	48 kHz Sampling : 4 Hz to 22 kHz 96 kHz Sampling : 4 Hz to 44 kHz
	*S/N Ratio	110 dB
	*Dynamic Range	100 dB
	*Total Harmonic Distortion	0.004 %

* : Nominal specification

- Samsung Electronics Co., Ltd reserves the right to change the specifications without notice.
- Weight and dimensions are approximate.



UNITED KINGDOM

This Samsung product is warranted for the period of twelve (12) months from the original date of purchase, against defective materials and workmanship. In the event that warranty service is required, you should return the product to the retailer from whom it was purchased.

However, Samsung Authorised Dealers and Authorised Service Centres in other EC Countries will comply with the warranty on the terms issued to purchasers in the country concerned. In case of difficulty, details of our Authorised Service Centres are available from:

**Samsung Electronics (U.K.) Ltd.,
Euro Service Centre, Stafford Park 12,
TELFORD, Shropshire TF3 3BJ,
Tel: 0870) 242 0303, Fax: 01952 297617**

■ WARRANTY CONDITIONS

1. The warranty is only valid if, when warranty service is required, the warranty card is fully and properly completed and is presented with the original invoice or sales slip or confirmation, and the serial number on the product has not been defaced.
2. Samsung's obligations are limited to the repair or, at its discretion, replacement of the product or the defective part.
3. Warranty repairs must be carried out by Authorised Samsung Dealers or Authorised Service Centres.
No re-imburement will be made for repairs carried out by non Samsung Dealers and, any such repair work and damage to the products caused by such repair work will not be covered by this warranty.
4. This product is not considered to be defective in materials nor workmanship by reason that it requires adaptation in order to conform to national or local technical or safety standards in force in any Country other than the one for which the product was originally designed and manufactured. This warranty will not cover, and no re-imburement will be made for such adaptation nor any damage which may result.



REPUBLIC OF IRELAND

5. This warranty covers none of the following:
 - a) Periodic check ups, maintenance and repair or replacement of parts due to normal wear and tear.
 - b) Cost relating to transport, removal or installation of the product.
 - c) Misuse, including the failure to use this product for its normal purposes or incorrect installation.
 - d) Damage caused by Lightning, Water, Fire, Acts of God, War, Public Disturbances, incorrect mains voltage, improper ventilation or any other cause beyond the control of Samsung.
6. This warranty is valid for any person who legally acquired possession of the product during the warranty period.
7. The consumers statutory rights in any applicable national legislation whether against the retailer arising from the purchase contract or otherwise are not affected by this warranty. Unless there is national legislation to the contrary, the rights under this warranty are the consumers sole rights and Samsung, its subsidiaries and distributors shall not be liable for indirect or consequential loss or any damage to records, compact discs, videos or audio taper or any other related equipment or material.

SAMSUNG ELECTRONICS (U.K.) LTD.