

KAWAI
DIGITAL PIANO

CL20

OWNER'S MANUAL

Thank you for choosing this Kawai CL20 Digital Piano.
 Your new CL20 is a high-quality instrument offering the very latest in leading-edge music technology.
 This manual contains valuable information that will help you make full use of your CL20 piano's
 many capabilities. Please read it carefully and keep it handy for further reference.

TABLE OF CONTENTS

	Page
Important Safety Instructions	3
Assembling The Stand	6
Part Names	8
Getting Started	10
1. Basic Operations	10
2. Dual	11
3. Metronome	11
4. Concert Magic	12
5. Demonstration Song	16
Function Mode	17
1. Selecting A Touch Type	18
2. Transpose	19
3. Tuning	19
4. Reverb	20
5. Concert Magic Mode	20
6. MIDI Channel Select	21
7. MIDI Local Control	21
8. Turning Multi-Timbral Mode On/Off	22
9. Transmit MIDI Program Change	23
MIDI	24
Concert Magic Song List	25
Specifications	26
MIDI Implementation Chart	27

Important Safety Instructions

SAVE THESE INSTRUCTIONS

INSTRUCTIONS PERTAINING TO A RISK OF FIRE, ELECTRIC SHOCK, OR INJURY TO PERSONS



WARNING

TO REDUCE THE RISK OF FIRE OR ELECTRIC SHOCK, DO NOT EXPOSE THIS PRODUCT TO RAIN OR MOISTURE.

AVIS : RISQUE DE CHOC ELECTRIQUE - NE PAS OUVRIR.

TO REDUCE THE RISK OF ELECTRIC SHOCK, DO NOT REMOVE COVER (OR BACK). NO USER-SERVICEABLE PARTS INSIDE. REFER SERVICING TO QUALIFIED SERVICE PERSONNEL.



The lightning flash with arrowhead symbol, within an equilateral triangle, is intended to alert the user to the presence of uninsulated "dangerous voltage" within the product's enclosure that may be of sufficient magnitude to constitute a risk of electric shock to persons.



The exclamation point within an equilateral triangle is intended to alert the user to the presence of important operating and maintenance (servicing) instructions in the literature accompanying the product.

Examples of Picture Symbols



denotes that care should be taken. The example instructs the user to take care not to allow fingers to be trapped.



denotes a prohibited operation. The example instructs that disassembly of the product is prohibited.



denotes an operation that should be carried out. The example instructs the user to remove the power cord plug from the AC outlet.

Read all the instructions before using the product.

WARNING - When using electric products, basic precautions should always be followed, including the following.



WARNING Indicates a potential hazard that could result in death or serious injury if the product is handled incorrectly.

The product should be connected to an AC outlet of the specified voltage.



- Use the AC adapter supplied with the product or one recommended by Kawai.
- If you are going to use an AC power cord, make sure that its has the correct plug shape and conforms to the specified power voltage.
- Failure to do so may result in fire.

Do not insert or disconnect the power cord plug with wet hands.



Doing so may cause electric shock.

When using the headphones, do not listen for long periods of time at high volume levels.

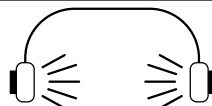

Doing so may result in hearing problems.

Do not disassemble, repair or modify the product.



Doing so may result in product breakdown, electric shock or short-circuit.

When disconnecting the AC power cord's plug, always hold the plug and pull it to remove it.



● Pulling the AC power cord itself may damage the cord, causing a fire, electric shock or short-circuit.

The product is not completely disconnected from the power supply even when the power switch is turned off. If the product will not be used for a long time, unplug the AC power cord from the AC outlet.



● Failure to do so may cause fire in case of lightning.
● Failure to do so may over-heat the product, resulting in fire.

This product may be equipped with a polarized line plug (one blade wider than the other). This is a safety feature. If you are unable to insert the plug into the outlet, contact an electrician to replace your obsolete outlet. Do not defeat the safety purpose of the plug.

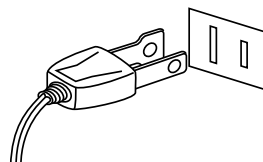

CAUTION

Indicates a potential hazard that could result in injury or damage to the product or other

Do not use the product in the following areas.

- Areas, such as those near windows, where the product is exposed to direct sunlight
- Extremely hot areas, such as near a heater
- Extremely cold areas, such as outside
- Extremely humid areas
- Areas where a large amount of sand or dust is present
- Areas where the product is exposed to excessive vibrations

Using the product in such areas may result in product breakdown. Use the product only in moderate climates (not in tropical climates).

Before connecting cords, make sure that the power to this product and other devices is turned OFF.



Failure to do so may cause breakdown of this product and other devices. El producto debe ser protegido del agua y de las salpicaduras. No se debe de apoyar en el instrumento ning n objeto que contenga l quido, como jarrones.

Take care not to allow any foreign matter to enter the product.

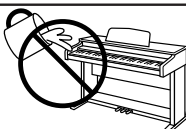

Entry of water, needles or hair pins may result in breakdown or short-circuit. The product shall not be exposed to dripping or splashing. No objects filled with liquids, such as vases, shall be placed on the product.

Do not drag the product on the floor. Take care not to drop the product.

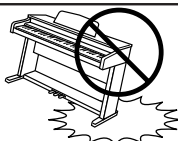

Please lift up the product when moving it. Please note that the product is heavy and must be carried by more than two persons. Dropping the product may result in breakdown.

Do not place the product near electrical appliances such as TVs and radios.



● Doing so may cause the product to generate noise.
● If the product generates noise, move the product sufficiently away from the electrical appliance or connect it to another AC outlet.

When connecting the AC power cord and other cords, take care not to get them tangled.



Failure to do so may damage them, resulting in fire, electric shock or short-circuit.

Do not wipe the product with benzene or thinner.



● Doing so may result in discoloration or deformation of the product.
● When cleaning the product, put a soft cloth in lukewarm water, squeeze it well, then wipe the product.

Do not stand on the product or exert excessive force.



- Doing so may cause the product to become deformed or fall over, resulting in breakdown or injury.

The product should be located so that its location or position does not interfere with its proper ventilation. Ensure a minimum distance of 5cm around the product for sufficient ventilation. Ensure that the ventilation is not impeded by covering the ventilation openings with items, such as newspaper, table-cloths, curtains, etc.

Do not place naked flame sources, such as lighted candles on the product.

The product should be serviced by qualified service personnel when:

- The power supply cord or the plug has been damaged.
- Objects have fallen, or liquid has been spilled into the product.
- The product has been exposed to rain.
- The product does not appear to operate normally or exhibits a marked change in performance.
- The product has been dropped, or the enclosure damaged.

Notes on Repair

Should an abnormality occur in the product, immediately turn the power OFF, disconnect the power cord plug, and then contact the shop from which the product was purchased.

CAUTION:

To prevent electric shock, match wide blade of plug to wide slot, fully insert.

ATTENTION:

Pour éviter les chocs électriques, introduire la lame la plus large de la fiche dans la borne correspondante de la prise et pousser jusqu'au fond.

Instruction for AC power cord (U.K.)

Do not plug either terminal of the power cord to the ground of the AC outlet on the wall.

FCC Information

This equipment has been tested and found to comply with the limits for a Class B digital device, pursuant to Part 15 of the FCC Rules. These limits are designed to provide reasonable protection against harmful interference in a residential installation. This equipment generates, uses and can radiate radio frequency energy and, if not installed and used in accordance with the instructions, may cause harmful interference to radio communications.

If this equipment does cause harmful interference to radio or television reception, which can be determined by turning the equipment off and on, the user is encouraged to try to correct the interference by one or more of the following measures:

- ¥ Reorient or relocate the receiving antenna.
- ¥ Increase the separation between the equipment and receiver.
- ¥ Connect the equipment into an outlet on a different electrical circuit from the receiver.
- ¥ Consult the dealer or an experienced radio/TV technician for help.

Canadian Radio Interference Regulations

This instrument complies with the limits for a class B digital apparatus, pursuant to the Radio Interference Regulations, C.R.C., c. 1374.

ASSEMBLING THE STAND

Be sure that all parts are included before starting to assemble your unit.

PARTS PROVIDED

Main Unit	1pc.	Music Rack	1pc.
Side Board	2pcs.	Screw (Long)	4pcs.
Back Board	1pc.	Screw (Short)	4pcs.

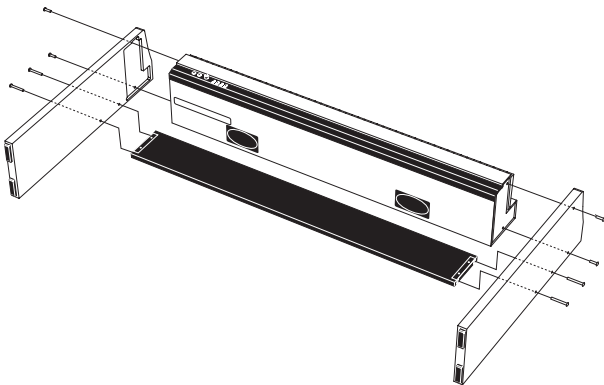
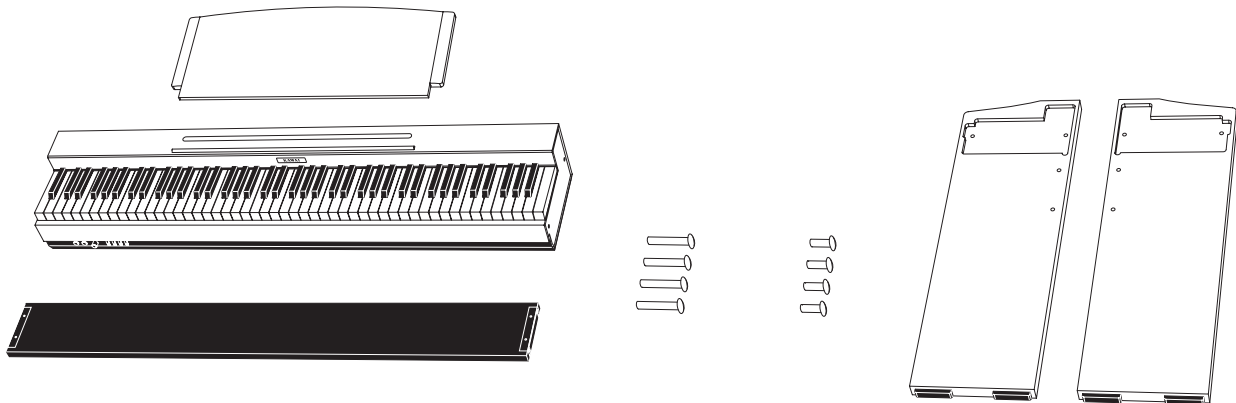

1. Place the Main Unit on the floor with its back side facing down.

2. Put the Side Boards beside the Main Unit as shown in the illustration on the left.

3. Put together the Main Unit and Side Boards and fasten with four screws (short).

4. Fasten the Back Board with four screws (long) tightly. Make sure that all screws are fastened securely.

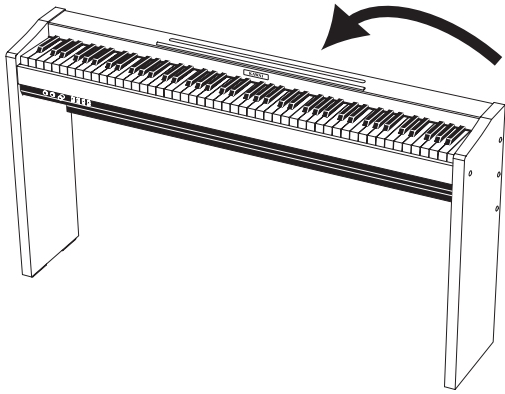

5. Raise the stand up and make sure the screws are tight enough.

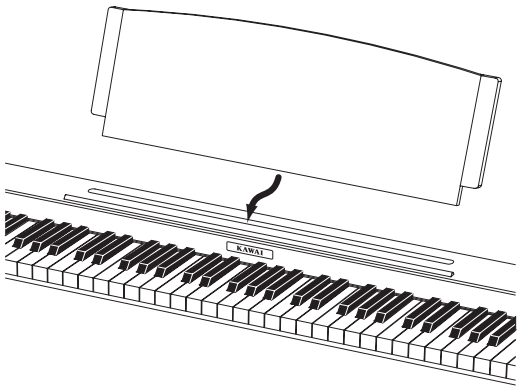

6. Insert the Music Rack in the slit on the top of the piano.

PART NAMES

HEADPHONES JACKS (A)

Used to connect up to two headphones to this digital piano.

POWER/VOLUME KNOB (B)

Turn the knob to the right and turn the power on. Continue turning the volume knob to the right to increase the instrument's volume. Turn the knob to the left to decrease the volume.

SOUND SELECT BUTTON (C)

Select the desired instrument by pressing this button repeatedly. You can also select a specific instrument directly by pressing one of the lowest eight white keys while holding down this button. For more details, see page 10.

METRONOME BUTTON (D)

Use this button to turn on/off the metronome.

CONCERT MAGIC BUTTON (E)

Absolutely anyone can play a real music with Concert Magic... even if you've never taken a piano lesson in your life. All you have to do is to select a favorite song and tap any of the 88 keys. For more details, see page 12.

DEMO BUTTON (F)

To listen to all the demos, simply press this button. The CL20 piano will start the demo. Eight musical pieces will be played back until the DEMO button is pressed again to stop. To select a specific demo, see page 16. To stop the demo, press this button again.

FRONT PANEL

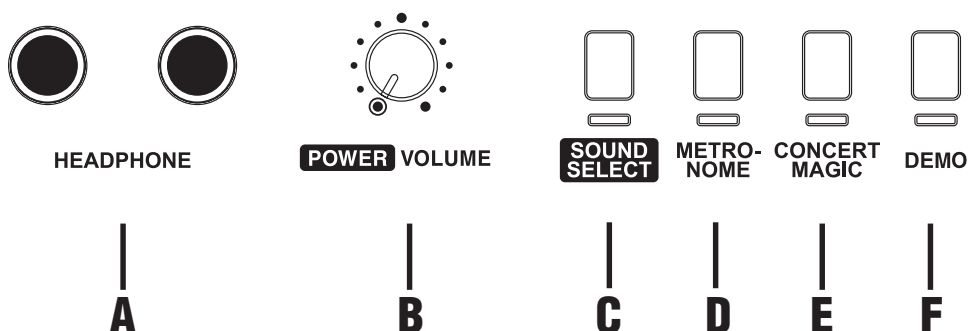

MIDI JACKS (G)

Use these jacks to connect the CL20 piano with external MIDI devices.

PEDAL JACK (H)

Connect the enclosed foot pedal. You can also connect an optional F-2r foot pedal which has a soft pedal as well.

DC IN JACK (I)

Connect the enclosed AC adaptor.

BACK PANEL

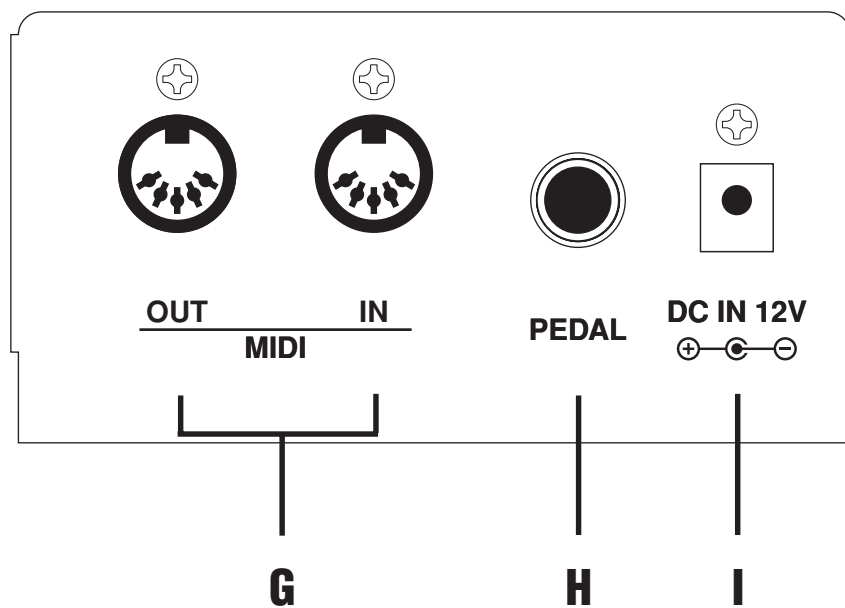

GETTING STARTED

1. BASIC OPERATIONS



(1) Turn the volume knob to the right and turn the power on.

(2) Adjust the volume.

Play a note on the keyboard and adjust the volume. (Turning the knob to the right raises the volume while turning to the left lowers it.)

(3) Choose a sound.



Method 1

Pressing the SOUND SELECT button once will change the sound to the next. Press it repeatedly until the desired sound is selected.

Method 2

While holding down the SOUND SELECT button, press one of the lowest 8 white keys to select a specific sound directly.

Method 3

Press and hold the SOUND SELECT button more than one second to go back to Concert Grand.

Note:

When a sound other than Concert Grand is selected, the LED indicator under the SOUND SELECT button will start flashing.

(4) Play.

Experiment by playing the different sounds.

SOUND LIST

- 1 Concert Grand
- 2 Modern Piano
- 3 Electric Piano
- 4 Church Organ
- 5 Harpsichord
- 6 Vibraphone
- 7 Strings
- 8 Choir

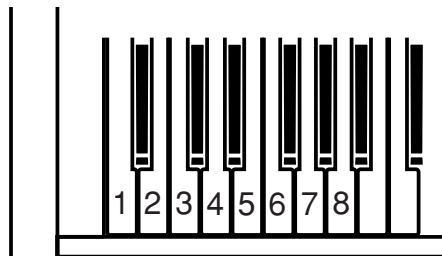

2. DUAL

With DUAL mode, you can layer two sounds together. To layer two sounds, while holding down the SOUND SELECT button, press the desired two keys together at the lowest 8 white keys and the assigned two sounds will be layered.

3. METRONOME

The CL20 piano's metronome function can help you practice the piano by providing a steady beat for you to play along with.



(1) To start the metronome, press the METRONOME button.

(2) To turn off the metronome, press the METRONOME button again.

Changing the Beat (Time Signature)

You can change the beat (time signature) of the metronome. The CL20 piano has six beats (time signatures) to choose from, 1/4, 2/4, 3/4, 4/4, 5/4 and 6/8. While holding down the METRONOME button, select the desired beat (time signature) of the metronome by pressing the black keys assigned to that beat (time signature).

Adjusting the Tempo

To adjust the tempo, use the lower white keys while holding down the METRONOME button. You can directly enter the desired tempo in "Beats Per Minute" (BPM) or use the - or + keys to make it slower or faster. The tempo range is 30-300 beats per minute. Use the enclosed function label for your convenience.

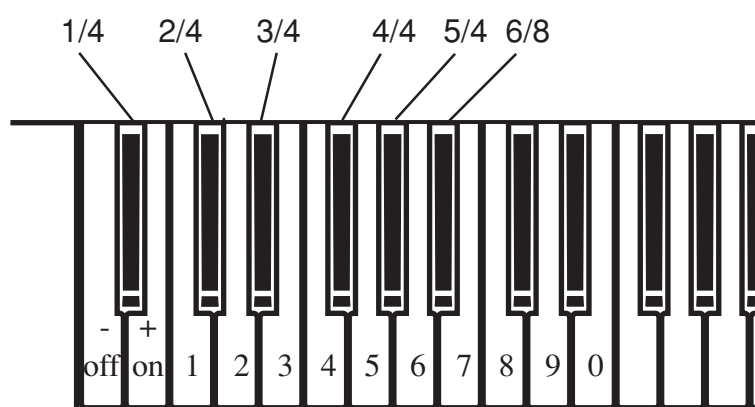

4. CONCERT MAGIC

The great German composer Johann Sebastian Bach once said, “Playing the keyboard is simple. Just strike right keys at the right time.” Many people wish it were that simple. The reality is very different of course. However, there is a way to make playing the keyboard very simple. You don’t even have to strike right keys thanks to Concert Magic.

With Concert Magic, absolutely anyone can sit at the CL20 piano and make real music... even if you’ve never taken a piano lesson in your life.

To enjoy performing by yourself, you have only to select your favorite piece from 40 preprogrammed songs and tap any of the 88 keys with a steady rhythm and tempo. Concert Magic will provide the correct melody and accompaniment notes, regardless of which keys you press. Anybody, young or old, can enjoy Concert Magic from the moment they sit down at the CL20 piano.

Now let’s see how Concert Magic works.

Selecting a Song

The 40 Concert Magic songs are assigned to each of the 40 white keys, classified in five groups by song category such as Children’s Songs, American Classics, Christmas Songs.

All of the song titles are listed on page 25.



To select a song, press the key to which your desired song is assigned while holding down the CONCERT MAGIC button.

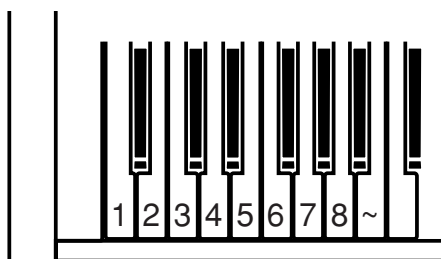

Listening to the Song

If you have selected a song you are familiar with, you may want to play by yourself right away. However you may want to listen to the song first before playing it.

To listen, press the DEMO button. The CL20 piano will start playing back the selected song.

If you want to listen to a different song, repeat the same procedure to select a song and press the DEMO button.

When you are finished listening to the song, press either CONCERT MAGIC button or DEMO button to stop.

Performing a song

Now you're ready to play yourself.

Tap out the rhythm of the selected song on any one of the 88 black or white keys on your piano keyboard. As you tap harder, the notes will get louder; as you tap softer, the notes will get quieter. As you tap faster, the notes speed up; as you tap slower, they will slow down correspondingly, just like regular piano playing.

Isn't it fun? You can sound like you've been playing for years just by pressing one key with one finger.

Concert Magic is a perfect method for small children to learn music, especially to develop a sense of rhythm. For older people who may think it is too late to learn the keyboard, Concert Magic is a good first step for them to begin with. With Concert Magic, your CL20 piano can be enjoyed by anyone in the family, even those who have never touched a musical instrument in their life.

Concert Magic Song Arrangement Types

After playing for a while with Concert Magic you may think that it's too easy and there is very little to learn.

While it is true that some of the songs are very easy to play, even for beginners, there are also some which will challenge you and require some practice to play beautifully. Each of the 40 Concert Magic songs falls into one of three different categories depending on the skill level required to perform them.

Easy Beat

These are the easiest songs to play. To perform them, simply tap out a constant steady beat on any key on your piano keyboard.

Look at the following example, “Für Elise”. Press the key with a steady sixteenth note rhythm.

Key on x x x x x x x x x x x x x x x x x x x x x x

Melody Play

These songs are also quite easy to play, especially if they are familiar to you. To perform them, tap out the rhythm of the melody on any one of the keys on your piano keyboard. Singing along as you tap the rhythm can be helpful.

Play “Twinkle, Twinkle, Little Star” for example. Follow the melody’s rhythm as shown.

Key on x x x x x x x x x x x x x x

When performing fast songs with Concert Magic, it is sometimes easier to tap two different keys with two fingers alternating. This allows you to play twice as fast as you can using only one finger on one key.

Skillful

These songs range in difficulty from moderately difficult to difficult. To perform them, tap out the rhythm of both the melody and the accompaniment notes on any of the keys on your piano keyboard, like “Waltz of The Flowers” shown below.

Key on x x x x x x x x x x x x x



The image shows a musical score for a piece in 3/4 time with a key signature of one sharp (F#). The score consists of two staves: a treble staff and a bass staff. Above the staves, a sequence of 'x' marks indicates a tapping rhythm: 'x x x' for the first measure, 'x x' for the second, 'x x x' for the third, 'x' for the fourth, 'x' for the fifth, and 'x x x' for the sixth. The treble staff contains a melody of quarter and eighth notes, while the bass staff contains a accompaniment of chords and single notes.

It may take some practice to get them just right. A good way to learn these songs is to listen to them first, and then try to tap out the rhythms that you hear.

In the song list on page 25, the arrangement type is marked next to each song title as “EB” for Easy Beat, “MP” for Melody Play and “SK” for Skillful.

Concert Magic Song Demo

There are three ways to listen to the Concert Magic songs in the DEMO mode.

1. All Play

Press the CONCERT MAGIC button and then press the DEMO button without selecting a song. The CL20 piano will play back all the preset songs from one to another.

2. Category Play

Press the piano key to which the desired song is assigned while holding down the CONCERT MAGIC button. While still holding down the CONCERT MAGIC button, press the DEMO button. The CL20 piano will play back the selected song and, then play the rest of songs in the same song category one after another.

3. One Song Play

Press the piano key to which the desired song is assigned while holding down the CONCERT MAGIC button. Release the CONCERT MAGIC button and then press the DEMO button. The CL20 will playback the selected song repeatedly until you press the DEMO button again.

5. DEMONSTRATION SONG

The CL20 piano has 8 built-in demonstration songs for your listening enjoyment.



DEMO

(1) Press the DEMO button and the song for Concert Grand will start. When the Concert Grand demo song is finished, the CL20 piano will play all the other demo songs one at a time in random order.

(2) Press the SOUND SELECT button to skip to the next demo song.

(3) If you would like to listen to the demo for a particular sound, just press the desired key at the lowest 8 white keys while holding down the SOUND SELECT button.

(4) To stop the demo, press the DEMO button again.

DEMO SONG LIST

1. Concert Grand Rhapsodie No.2 / Brahms
2. Modern Piano KAWAI original
3. Electric Piano KAWAI original
4. Church Organ Toccata / Eugene Gigout
5. Harpsichord French Suite No.6 / Bach
6. Vibraphone KAWAI original
7. Strings Le quattoro stagioni “La Primavera” / Vivaldi
8. Choir KAWAI original

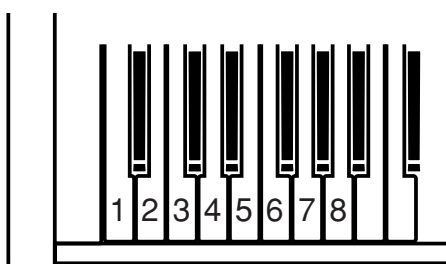

FUNCTION MODE

The Function Mode gives you access to many other useful features on your CL20 piano.

The following functions can be selected in the Function Mode by pressing the appropriate key:

<u>Function</u>	<u>Default</u>
TOUCH	Normal
TRANSPOSE	0
TUNING	A4=440.0Hz
REVERB	On
CONCERT MAGIC MODE	Mode 1
MIDI CHANNEL SELECT	1 ch
MIDI LOCAL CONTROL ON/OFF	On
MULTI TIMBRAL MODE ON/OFF	Off
TRANSMIT MIDI PROGRAM CHANGE	On

When the power is turned on, these functions are always set to the default settings.

OPERATION

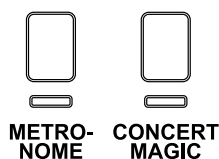

(1) Press the key assigned for the function you want to edit while holding down the METRONOME and CONCERT MAGIC buttons simultaneously.

(2) While still holding down the METRONOME and CONCERT MAGIC buttons, use the number keys or - (off) / + (on) keys to change the value for the selected function.

(3) You can also select other functions and change the values successively.

(4) Release both the METRONOME and CONCERT MAGIC buttons to exit.

Note:

Attach the enclosed Function Stickers as shown in the illustration on the next page for your convenience.

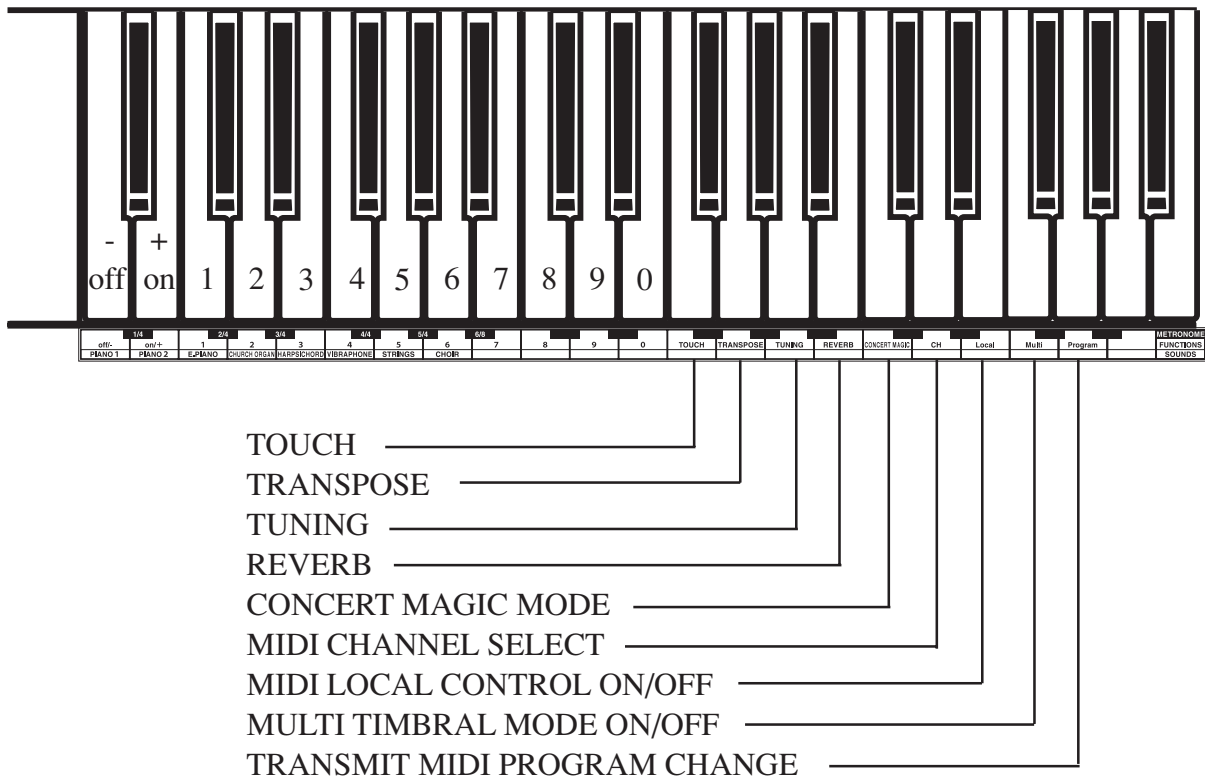

1. SELECTING A TOUCH TYPE

When playing a piano, the volume of the sound produced increases in direct relation to how hard a key is struck. Your CL20 piano lets you select from four different “Touch” types as follows:

NORMAL

The standard setting which produces volume in direct proportion to your force on the keys. This setting is the most similar to an acoustic piano. The CL20 piano automatically selects this Touch Type when the power is turned on.

LIGHT

For those still developing finger strength, such as a child, a louder sound is produced even when the piano is played with a soft touch.

HEAVY

Perfect for those with strong fingers or for practicing with a hard touch.

CONSTANT

For tone colors like organ or harpsichord, and for playing some contemporary music with the piano sound, a constant loud sound is produced regardless of your force on the keys.

(1) Press the “TOUCH” key while holding down the METRONOME and CONCERT MAGIC buttons.

(2) While still holding down the METRONOME and CONCERT MAGIC buttons, press one of the following keys on the keyboard.

Key 1: Selects the “LIGHT” Touch Type

Key 2: Selects the “NORMAL” Touch Type

Key 3: Selects the “HEAVY” Touch Type

Key 4: Selects the “CONSTANT” Touch Type

2. TRANSPOSE

The transpose function lets you raise or lower the piano’s key in half steps. This is especially useful when you have learned a song in one key and have to play it in another key. The transpose feature allows you to play the song in the original key, but hear it in another key.

(1) Press the “TRANSPOSE” key while holding down the METRONOME and CONCERT MAGIC buttons.

(2) While still holding down the METRONOME and CONCERT MAGIC buttons, press the desired key on the keyboard to select a new transposed key. (When power is first turned “on”, the key is set to C.) The piano can be transposed up to 5 half steps higher (F) or 6 half steps lower (F#).

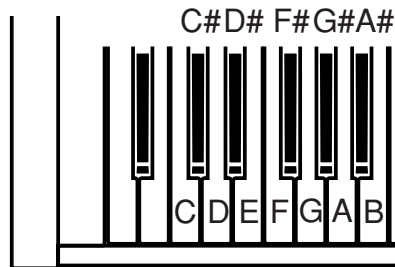

3. TUNING

This function allows you to adjust the piano’s pitch to match recordings or other instruments in an ensemble.

(1) Press the “TUNING” key while holding down the METRONOME and CONCERT MAGIC buttons. A tuning tone can be heard.

(2) While still holding down the METRONOME and CONCERT MAGIC buttons, use the -/+ keys to lower/raise the pitch by 0.5Hz. Or you can directly enter the center A pitch as a three digit number by using the number keys. (EX: 440)

4. REVERB

Reverb adds reverberation to the sound simulating the acoustic environment of a recital room, stage, or concert hall.

There are three types of Reverb in the CL20. They are Room, Stage and Hall.

(1) Press the “REVERB” key while holding down the METRONOME and CONCERT MAGIC buttons.

(2) While still holding the METRONOME and CONCERT MAGIC buttons, press one of the following keys to select the Reverb type.

Key 1: ROOM

Key 2: STAGE

Key 3: HALL

When the power is turned on, the REVERB function is automatically activated.

To turn on/off the reverb, while holding down the METRONOME and CONCERT MAGIC buttons, press REVERB key and then press “on” or “off” key.

5. CONCERT MAGIC MODE

The CL20 piano offers two ways to enjoy Concert Magic.

Mode 1

Each of the 40 Concert Magic songs falls into one of three different categories depending on the skill level required to perform them. They are Easy Beat, Melody Play and Skillful. See page 14 for details.

Mode 2

Regardless of which arrangement type a Concert Magic song is, with Mode 2 you can play any Concert Magic song by simply tapping any key with a constant steady beat.

(1) Press the “CONCERT MAGIC” key while holding down the METRONOME and CONCERT MAGIC buttons.

(2) While still holding down the METRONOME and CONCERT MAGIC buttons, pressing the “+” key sets the Concert Magic mode to

Mode 2. If you press the “-” key, the Concert Magic mode returns to Mode 1.

6. MIDI CHANNEL SELECT

In order to exchange MIDI information with another MIDI instrument, you must first set the two connected instruments to the same channel.

(1) Press the “MIDI CH” key while holding down the METRONOME and CONCERT MAGIC buttons.

(2) While still holding down the METRONOME and CONCERT MAGIC buttons, press the 10 keys to select the channel. When selecting a channel, the channel must be entered by two digit numbers.

EX: For CH 1 press the 0 key then the 1 key.
For CH 16 press the 1 key then the 6 key.

7. MIDI LOCAL CONTROL ON/OFF

This function is used to control whether or not the sound from the piano will be heard when you play the keyboard. When MIDI LOCAL CONTROL is set to “on” you will hear the CL20 piano when you play. When MIDI LOCAL CONTROL is set to “off” you will not hear any sound from the CL20 piano when you play but the CL20 piano’s keyboard data will be transmitted through the MIDI jacks to an external MIDI device.

(1) Press the “LOCAL” key while holding down the METRONOME and CONCERT MAGIC buttons.

(2) While still holding down the METRONOME and CONCERT MAGIC buttons, pressing the “off” key sets the Local Control to “off”. If you press the “on” key, this function returns to “on”.

8. TURNING MULTI-TIMBRAL MODE ON/OFF

Normally, the procedure described in the MIDI CHANNEL SELECT section is used to transmit or receive data on only one MIDI channel (any one of 1 through 16). But by turning the Multi-Timbral function “on”, you can receive data on more than one MIDI channel and simultaneously play a different sound on each channel. With this feature, you can connect the CL20 piano to an external MIDI recorder

or personal computer to create performances with a variety of timbres. The term “Multi-Timbral” is derived from the ability to play multiple timbres simultaneously.

NOTE:

You can assign any sound of the CL20 piano to any channel in the way you like by sending the correct Program Change Number to the CL20 piano from an external MIDI device. Please refer to the list below for assignment of sound and program number.

(1) Press the “MULTI” key while holding down the METRONOME and CONCERT MAGIC buttons.

(2) While still holding down the METRONOME and CONCERT MAGIC buttons, pressing the “off” key sets the Multi-Timbral mode to “off”. If you press the “on” key, this function returns to “on”.

<u>Sound</u>	<u>Program Number</u>	
	<u>Multi-Timbre “on”</u>	<u>Multi-Timbre “off”</u>
Concert Grand	1	1
Modern Piano	2	2
Electric Piano	5	3
Church Organ	20	4
Harpsichord	7	5
Vibraphone	12	6
Strings	49	7
Choir	53	8

9. TRANSMIT MIDI PROGRAM CHANGE

You can set the CL20 piano if it should transmit Program Change Numbers via MIDI when the sound is changed on the control panel.

(1) Press the “PROGRAM” key while holding down the METRONOME and CONCERT MAGIC buttons.

(2) While still holding down the METRONOME and CONCERT MAGIC buttons, pressing the “off” key sets the CL20 piano not to transmit the program change data corresponding to the sound selected on the panel. If you press the “on” key, this function returns to “on” and selecting a sound will transmit the data.

(3) You can also transmit the desired program change number directly by entering the number as a three digit number by using the number

keys while holding down the METRONOME and CONCERT MAGIC buttons.

MIDI

The term MIDI is an acronym for Musical Instrument Digital Interface, an international standard for connecting synthesizers, sequencers (MIDI recorders) and other electronic instruments so that they can exchange performance data.

The CL20 is equipped with two MIDI jacks for exchanging data: MIDI IN and MIDI OUT. Each uses a special cable with a DIN connector.

MIDI IN : For receiving note, program change and other data.

MIDI OUT : For sending note, program change and other data.

MIDI EXAMPLES

(1) Connection to another MIDI compatible keyboard or sound generator module

When connected as shown in the illustration, data on how the digital piano is played (which keys are struck) can be sent to another MIDI instrument. Plus, the sound from the CL20 can be layered over the sound of the other instrument.

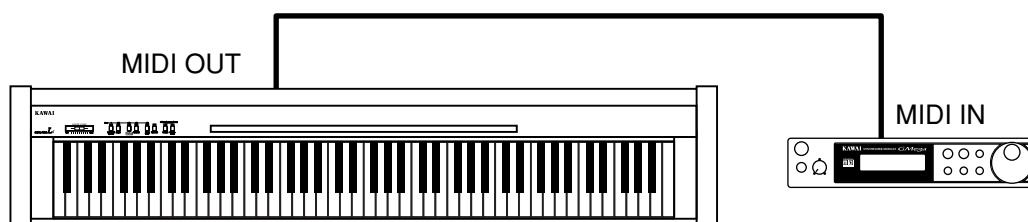

(2) Connection to an external sequencer

When connected as shown in the illustration, you can record songs played on the CL20 with a MIDI recorder, and use the CL20's tones (such as piano, harpsichord and vibraphone, etc.) controlled by the CL20's MULTI-TIMBRAL MODE function to create a multi-layer MIDI recording.

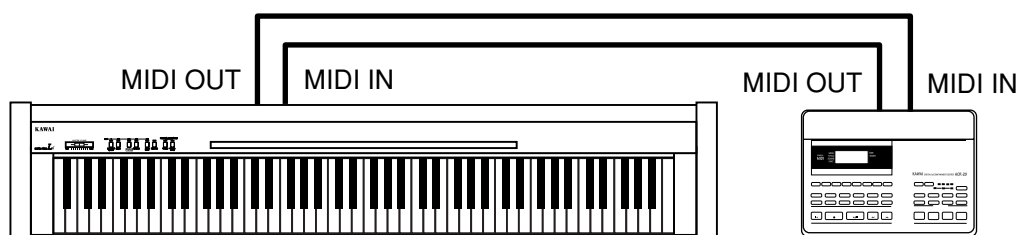

CONCERT MAGIC SONG LIST

Category	#	Song Title	Arrangement Type
Children's Songs	1	Twinkle, Twinkle, Little Star	MP
	2	I'm A Little Teapot	MP
	3	Mary Had A Little Lamb	MP
	4	London Bridge	MP
	5	Row, Row, Row Your Boat	MP
	6	Frère Jaques	MP
	7	Old MacDonald Had A Farm	MP
Christmas Songs	8	Hark The Herald Angels Sing	MP
	9	Jingle Bells	MP
	10	Deck The Halls	MP
	11	O Come All Ye Faithful	MP
	12	Joy To The World	MP
	13	Silent Night	MP
	14	We Wish You A Merry Christmas	MP
American Classics	15	Battle Hymn Of The Republic	MP
	16	Yankee Doodle	MP
	17	Danny Boy	EB
	18	Clementine	MP
	19	Auld Lang Syne	MP
	20	Oh Susanna	SK
	21	Camptown Races	MP
	22	When The Saints Go Marching In	EB
	23	The Entertainer	SK
Classical Selections	24	William Tell Overture	SK
	25	Andante (Haydn)	MP
	26	Für Elise	EB
	27	Clair De Lune	SK
	28	Skater's Waltz	SK
	29	Blue Danube Waltz	SK
	30	Gavotte (Gossec)	SK
	31	Waltz Of The Flowers	SK
Special Occations	32	Bridal Chorus	MP
	33	Wedding March	SK
	34	Pomp And Circumstance	SK
International Songs	35	When Irish Eyes Are Smiling	EB
	36	Hava Nagilah	EB
	37	Ich Bin Ein Musikant	SK
	38	Funicli Funicla	SK
	39	La Marseillaise	MP
	40	La Bamba	SK

SPECIFICATIONS

Keyboard	88 Weighted Keys with Advanced Hammer Action III
Touch Type	4 Types (Normal, Light, Heavy, Constant)
Max Polyphony	32 Notes
Tones	8 Tones (Concert Grand, Modern Piano, Electric Piano, Church Organ, Harpsichord, Vibraphone, Strings, Choir)
Reverb	Room, Stage, Hall
Metronome	Beat: 1/4, 2/4, 3/4, 4/4, 5/4, 6/8 Tempo: 30-300 BPM
Other Functions	Dual, Transpose, Tuning, Concert Magic (40 Songs), MIDI Functions, 8 Demo Songs
Pedals	Foot Switch (Damper Pedal)
Jacks	Headphones x 2, Pedal, MIDI IN/OUT, DC IN
Speakers	(12 x 8) cm (4 3/4" x 3 1/4") x 2
Output Power	7 W x 2
Power Consumption	25W (AC Adaptor PS-125)
Dimensions	129.1 x 26.8 x 77.2 (cm), 50 7/8" x 10 1/2" x 30 2/5"
Weight	27 kg (60 lbs.)

Specifications are subject to change without notice.

MIDI IMPLEMENTATION CHART

KAWAI DIGITAL PIANO
MODEL: CL20

Date: June 2004
Version: 1.0

FUNCTION	TRANSMITTED	RECEIVED	REMARKS
Basic Channel (Default) (Changed)	1 1-16	1 1-16	
Mode (Default) (Message) (Altered)	3 X *****	1 1, 3*	*Omni Off by setting MIDI channel
Note Number (True Voice)	15-113* *****	0-127 15-113	*with Transpose
Velocity (Note ON) (Note OFF)	O: 9nH v=1-127 X: 8nH v=0	O X	
After Touch Key's Channel's	X X	X X	
Pitch Bend	X	X	
Control Change 7 64 67	X O O (w/optional F-2r)	O O O	Volume Damper pedal Soft pedal
Program Change True	O *****	O	
System Exclusive	O	O	
Common (Song Position) (Song Select) (Tune)	X X X	X X X	
System: Real Time (Clock) (Commands)	X X	X X	
Others (Local ON/OFF) (All Notes OFF) (Active Sense) (Reset)	X X O X	O O* O* X	*When Multi-Timbral mode is On
Mode 1: OMNI ON, POLY Mode 2: OMNI ON, MONO Mode 3: OMNI OFF, POLY Mode 4: OMNI OFF, MONO			O: Yes X: No

KAWAI