

---

# Kodak EasyShare Z650 zoom digital camera



## User's guide

[www.kodak.com](http://www.kodak.com)

For interactive tutorials, [www.kodak.com/go/howto](http://www.kodak.com/go/howto)

For help with your camera, [www.kodak.com/go/z650support](http://www.kodak.com/go/z650support)



Eastman Kodak Company  
Rochester, New York 14650

© Eastman Kodak Company, 2005

All screen images are simulated.

Kodak and EasyShare are trademarks of Eastman Kodak Company.

Schneider-Kreuznach and C-Variogon are trademarks of Jos. Schneider Optische Werke GmbH used under license by Eastman Kodak Company.

P/N 4J4303\_en

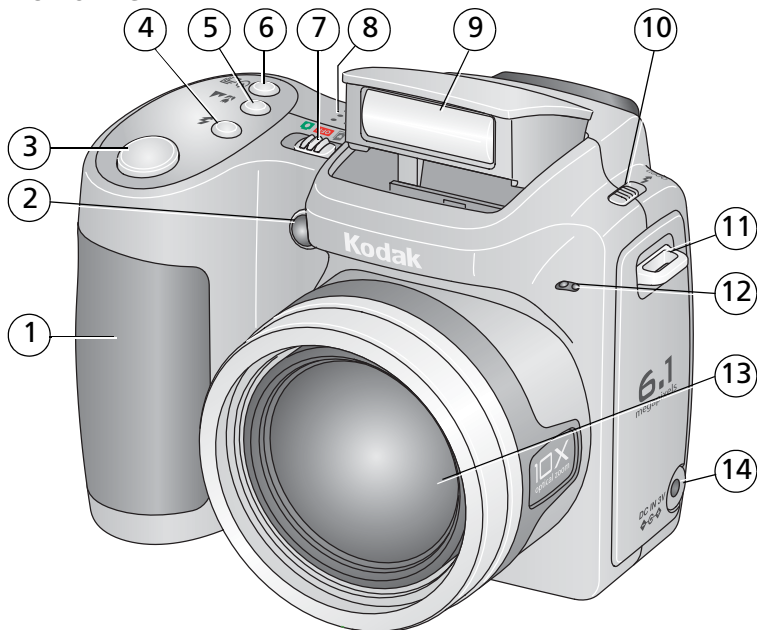

## Front view

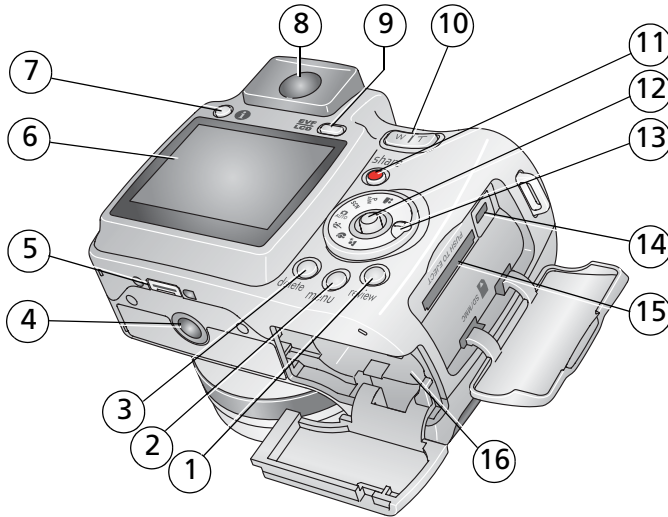

- |   |                                    |    |   |
|---|------------------------------------|----|---|
| 1 | Grip                               | 8  | Speaker   |
| 2 | Low-light assist, Self-timer light | 9  | Flash   |
| 3 | Shutter button                     | 10 | Open Flash switch   |
| 4 | Flash button                       | 11 | Neck strap post   |
| 5 | Close-up/Landscape button          | 12 | Microphone  |
| 6 | Self-timer/Burst button            | 13 | Lens  |
| 7 | Power/Favorites switch             | 14 | DC-In (3V)  , for <b>optional</b> AC adapter |

## Back view



- |   |  |
|---|--|
| 1 Review button   | 9 EVF/LCD button   |
| 2 Menu button   | 10 Zoom (Wide Angle/Telephoto)   |
| 3 Delete button   | 11 Share button  |
| 4 Tripod socket   | 12 Joystick/OK button  |
| 5 Dock connector  | 13 Mode dial   |
| 6 LCD   | 14 USB, A/V Out  |
| 7 Info button  | 15 Slot for optional SD or MMC card  |
| 8 EVF (Electronic viewfinder)   | 16 Battery compartment   |

---

# Table of contents

<b>1</b>	<b>Setting up your camera</b>	<b>1</b>
	Installing the software	1
	Attaching the lens cap and strap	1
	Loading the batteries	2
	Turning on the camera	3
	Setting the language and date/time	3
	Storing pictures on an SD or MMC card	4
<b>2</b>	<b>Taking pictures and videos</b>	<b>5</b>
	Taking a picture	5
	Using optical zoom	8
	Using the flip-up flash	9
	Using the info button	9
	Reviewing pictures and videos	11
	Deleting pictures and videos	13
<b>3</b>	<b>Transferring and printing pictures</b>	<b>14</b>
	Installing the software	14
	Transferring pictures	15
	Printing pictures	16
	Dock compatibility for your camera	19
<b>4</b>	<b>Doing more with your camera</b>	<b>20</b>
	Changing the flash settings	20
	Using the self-timer	21
	Capture modes	22
	Taking close-up and landscape pictures	25
	Using burst	26
	Running a slide show	26
	Changing picture-taking settings	28
	Customizing your camera	31
	Cropping pictures	34

Viewing picture/video information .....	34
Copying pictures and videos .....	35
Adjusting exposure compensation .....	36
Using the histogram to view picture brightness .....	36
P, A, S, and M modes.....	37
Pre-tagging for album names .....	39
Tagging pictures/videos for albums.....	40
Sharing your pictures.....	41
<b>5 Troubleshooting .....</b>	<b>46</b>
Camera problems.....	46
Computer/connectivity problems.....	48
Picture quality problems .....	48
Direct printing (PictBridge) problems.....	50
<b>6 Getting help .....</b>	<b>51</b>
Helpful links.....	51
Telephone customer support .....	52
<b>7 Appendix .....</b>	<b>53</b>
Camera specifications .....	53
Storage capacities.....	57
Important safety instructions .....	58
Battery life .....	60
Upgrading your software and firmware.....	61
Additional care and maintenance .....	61
Warranty.....	62
Regulatory compliance .....	64

# 1

## Setting up your camera

### Installing the software

**IMPORTANT:** Before connecting any cables, install the software that was included with your camera. For details, see [Transferring and printing pictures, page 14](#).



Follow the on-screen instructions.  
We recommend Complete or Easy Install.

### Attaching the lens cap and strap

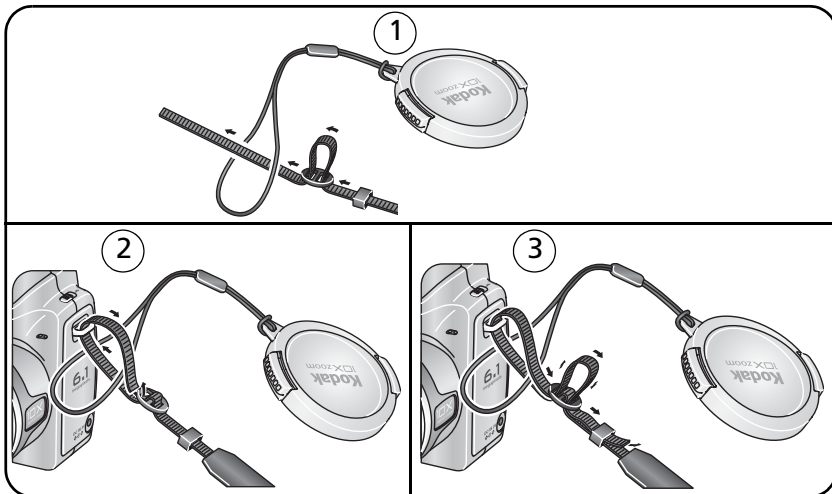

## Loading the batteries

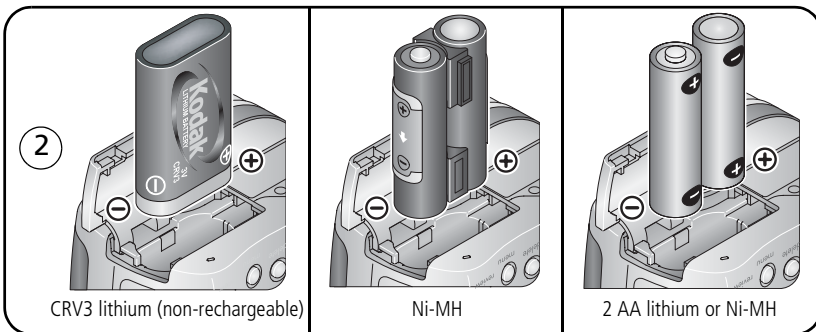
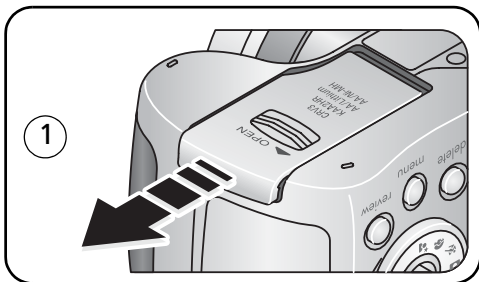

To replace batteries and extend battery life, see [page 60](#).

To recharge rechargeable batteries, see [page 61](#).



## Turning on the camera

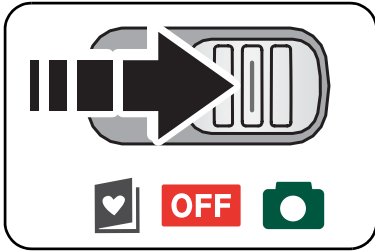

## Setting the language and date/time

- Language:**
- 1 ▲/▼ to change.
  - 2 OK to accept.
- Date/Time:**
- 1 At the prompt, press OK.
  - 2 ▲/▼ to change.  
◀/▶ for previous/next field.  
OK to accept.

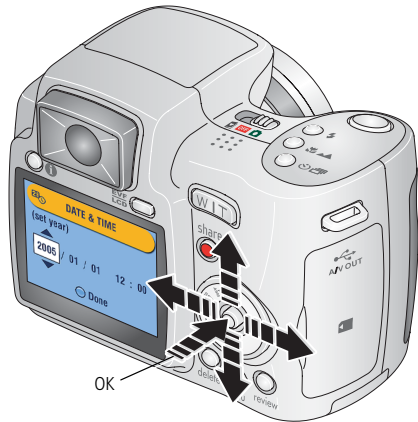

To set the language and date/time at a later time, see [Changing picture-taking settings](#) starting on [page 28](#).

## Storing pictures on an SD or MMC card

Your camera has internal memory. You can purchase SD or MMC cards to store more pictures and videos. (Visit [www.kodak.com/go/z650accessories](http://www.kodak.com/go/z650accessories). See [page 57](#) for storage capacities.)

NOTE: When using the card for the first time, format it in this camera before taking pictures (see [page 33](#)). We recommend Kodak SD or MMC cards.

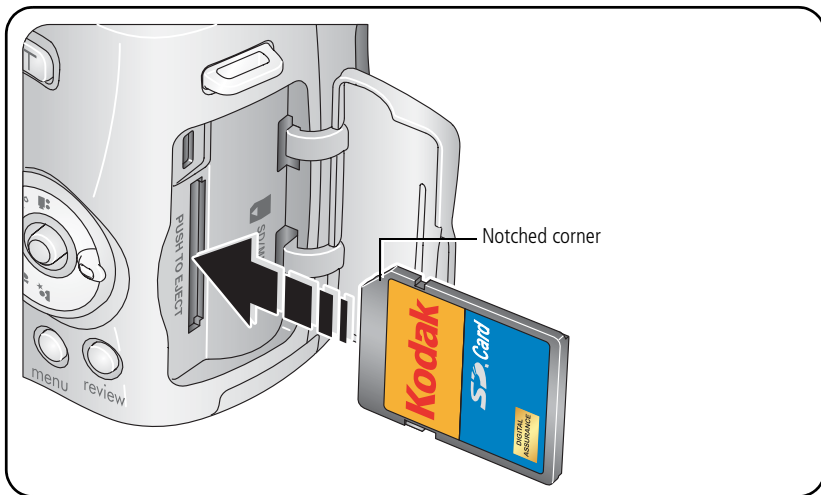



### CAUTION:

A card can only be inserted one way; forcing it may cause damage. Inserting or removing a card when the ready light is blinking may damage pictures, card, or camera.

# 2

## Taking pictures and videos

### Taking a picture

1   

2 Press the EVF/LCD button to turn on:  
• LCD or  
• EVF (electronic viewfinder)

3 Press the Shutter button halfway to focus and set exposure.  
When the AF/AE indicator turns green, press the Shutter button completely down.

**EVF/LCD** 

**AF/AE indicator:**  
● Green—successful  
● Red—failed  
**AF** Failed focus  
**AE** Failed exposure

NOTE: After you take a picture, the EVF/LCD displays a quickview for approximately 5 seconds. The picture is saved unless you press the Delete button.

## Taking a video

- 
- Press the EVF/LCD button to turn on:
  - LCD or
  - EVF (electronic viewfinder)
- Press the Shutter button completely down and release. To stop recording, press and release the Shutter button again.

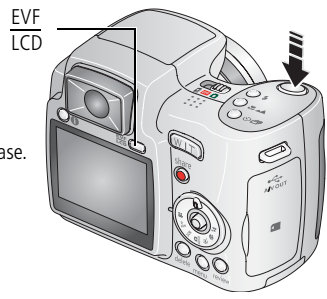

**NOTE:** After you take a video, the EVF/LCD displays a quickview for approximately 5 seconds. To play/pause the video during the quickview, press the OK button. The video is saved unless you press the Delete button.

## Using the auto-focus framing marks (pictures)

When using the LCD or EVF as a viewfinder, framing marks indicate the camera focus area. The camera attempts to focus on foreground subjects, even if the subjects are not centered in the scene.

- 1 Press the Shutter button **halfway**.

*When the framing marks turn green, focus is accomplished.*

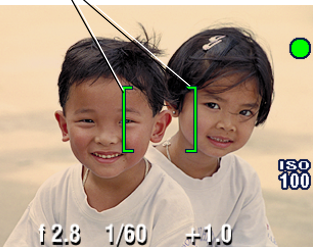
While the shutter button is pressed halfway:	
 <p>Framing marks</p>	[ ] [ ] Center focus
	[ ] [ ] Center wide focus
	[ ] [ ] Side focus
	[ ] [ ] Center and side focus
	[ ] [ ] Left and right focus

- 2 If the camera is not focusing on the desired subject (or if the framing marks disappear), release the Shutter button and recompose the scene.
- 3 Press the Shutter button **completely down** to take the picture.

NOTE: Framing marks do not appear in all modes. When you use Focus Zone and set Center Zone, the framing marks are fixed at Center Wide. (See [page 29](#).)

## Using optical zoom

Use optical zoom to get up to 10X closer to your subject. Optical zoom is effective when the lens is no closer than 24 in. (60 cm) to the subject or 5 in. (13 cm) in Close-up mode. You can change optical zoom before (but not during) video recording.

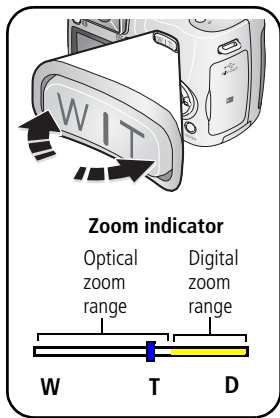

- 1 Use the viewfinder or LCD to frame your subject.
- 2 Press Telephoto (T) to zoom in. Press Wide Angle (W) to zoom out.  
*The zoom indicator shows zoom status.*
- 3 Take the picture or video.

## Using digital zoom

Use digital zoom in any Still mode to get up to 5X magnification beyond optical zoom.

- 1 Press the Telephoto (T) button to the optical zoom limit (10X). Release the button, then press it again.  
*The zoom indicator shows zoom status.*
- 2 Take the picture or video.

**NOTE:** You cannot use digital zoom for video recording. You may notice decreased image quality when using digital zoom. The blue slider on the zoom indicator pauses and turns red when the picture quality reaches the limit for an acceptable 4 x 6-in. (10 x 15 cm) print.

## Using the flip-up flash

Use the flash when you take pictures at night, indoors, or outdoors in heavy shadows. Make sure you are within flash range.

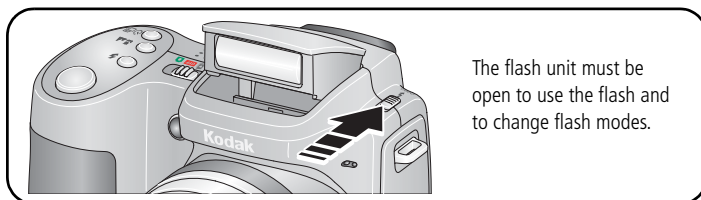

To change flash settings, see [page 20](#). To turn off the flash, close it.

Flash-to-subject distance	
Zoom position	Flash distance
Wide angle	2–16.1 ft (0.6–4.9 m)
Telephoto	6.6–12.1 ft (2.0–3.7 m)

## Using the info button

In picture-taking mode, repeatedly press Info button **i** to turn:

- Status icons on
- Status icons and histogram on
- Status icons and histogram off

In Review, repeatedly press Info button **i** to turn:

- Status icons and histogram on
- Status icons and histogram off
- Picture/Video information on

## What the capture icons mean

Capture modes—no buttons pressed

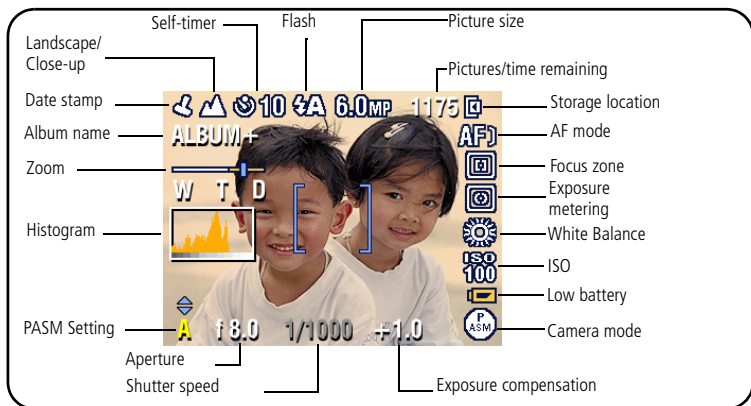

Capture modes—shutter pressed halfway

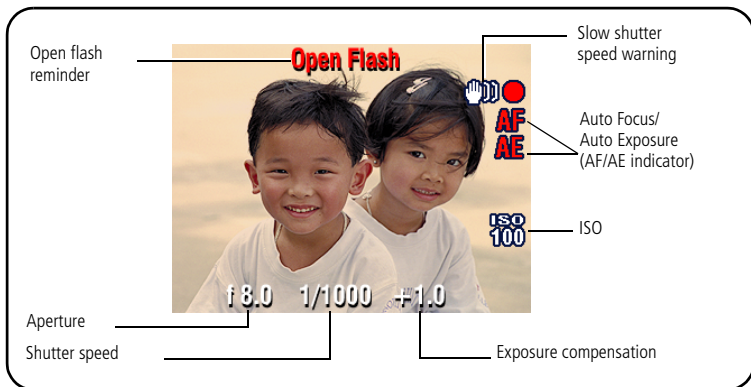



## Reviewing pictures and videos

Press the Review button to view and work with your pictures and videos.



**1** Review.  
(Press again to exit.)

**2** ◀▶ for previous/next.

**Videos:**

- OK Play/pause.
- ▲/▼ Adjust the volume.
- ◀◀ Rewind to beginning (during playback).
- ▶▶ Next picture/video (during playback).

To save battery power, use an optional Kodak EasyShare dock or Kodak 3-volt AC adapter. (See [www.kodak.com/go/z650accessories](http://www.kodak.com/go/z650accessories).)

NOTE: Pictures taken at the 5.3 MP (3:2) picture size are displayed at a 3:2 aspect ratio with a black bar at the top of the screen. A video's duration is displayed at the top of the LCD.

## What the review icons mean

### Pictures

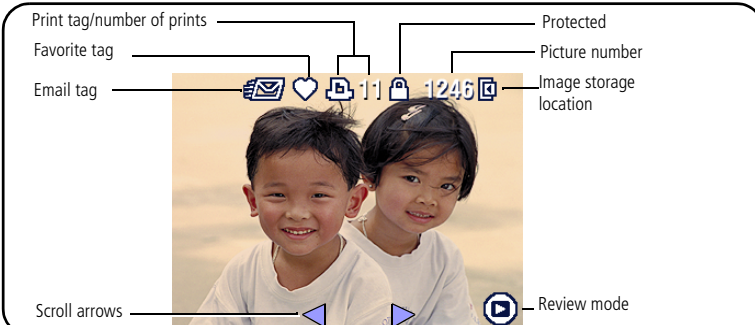

Print tag/number of prints

Favorite tag

Email tag

Protected

Picture number

Image storage location

Scroll arrows

Review mode

## Videos

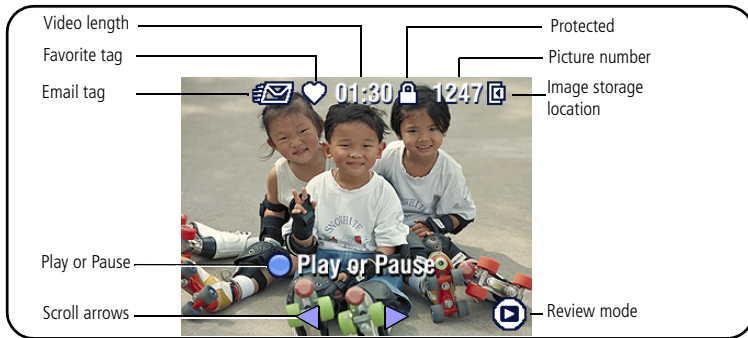

## Magnifying a picture during review

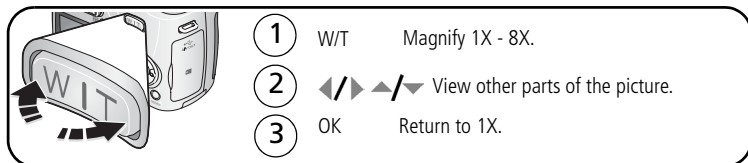

## Viewing multi-up (thumbnails) during review

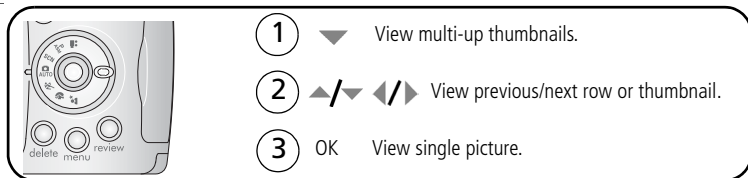

## Deleting pictures and videos



- 1 Press Review.
- 2 ◀▶ View previous/next.
- 3 Press Delete.
- 4 Follow the screen prompts.

**PICTURE or VIDEO**—deletes the displayed picture or video.

**EXIT**—exits the Delete screen.

**ALL**—deletes all pictures and videos from your current storage location.

**NOTE:** To delete protected pictures and videos, remove protection before deleting.

## Protecting pictures and videos from deletion

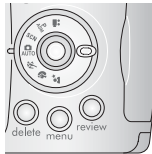

- 1 Press Review.
- 2 ◀▶ View previous/next.
- 3 Press Menu.
- 4 ▲/▼ Highlight Protect, then press OK.

*The picture or video is protected and cannot be deleted. The Protect icon  appears with the protected picture or video.*

Press the Menu button to exit the menu.



### CAUTION:

**Formatting internal memory or a card deletes all (including protected) pictures, videos, email addresses, album names, and favorites.**

# 3

## Transferring and printing pictures

### Installing the software



#### CAUTION:

Install Kodak EasyShare software *before* connecting the camera or optional dock to the computer. Failure to do so may cause the software to load incorrectly.

- 1 Close all software applications that are open on your computer (including anti-virus software).
- 2 Place the Kodak EasyShare software CD into the CD-ROM drive.
- 3 Load the software:

**Windows OS**—if the install window does not appear, choose Run from the Start menu and type **d:\setup.exe** where **d** is the drive letter that contains the CD.

**Mac OS X**—double-click the CD icon on the desktop, then click the Install icon.

- 4 Follow the on-screen instructions to install the software.

NOTE: When prompted, take a few minutes to electronically register your camera and software. To register later, see [www.kodak.com/go/register](http://www.kodak.com/go/register).

- 5 If prompted, restart the computer. If you turned off anti-virus software, turn it back on. See the anti-virus software manual for details.

For information on the software applications included on the EasyShare software CD, see EasyShare software help.

## Transferring pictures

**IMPORTANT:** If your camera was packaged with a Kodak EasyShare dock, use the dock to transfer pictures to your computer. (See [page 19](#) and the dock user's guide for details.) If your camera was not packaged with an EasyShare dock, use the USB cable (U-8) that came with your camera.

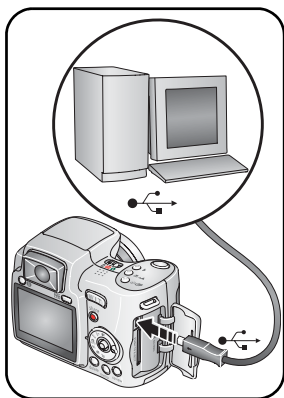

- 1 Turn off the camera.
- 2 Plug the labeled  end of the USB cable into the labeled USB port on your computer. See your computer user's guide for details.
- 3 Plug the other end of the USB cable into the USB port on the camera. The arrow icon on the cable should face you.
- 4 Turn on the camera.

*EasyShare software opens on your computer. The software prompts you through the transfer process.*

NOTE: Visit [www.kodak.com/go/howto](http://www.kodak.com/go/howto) for an online tutorial on connecting.

### Also available for transferring

You can also use these Kodak products to transfer your pictures and videos.

- Kodak EasyShare camera dock, Kodak EasyShare printer dock (see [page 19](#))
- Kodak multi-card reader, Kodak SD multimedia card reader-writer

Purchase these and other accessories at a dealer of Kodak products or [www.kodak.com/go/z650accessories](http://www.kodak.com/go/z650accessories).

## Printing pictures

### Printing with a Kodak EasyShare printer dock

Dock your camera to the Kodak EasyShare printer dock and print directly—with or without a computer. Purchase this and other accessories at a dealer of Kodak products or [www.kodak.com/go/z650accessories](http://www.kodak.com/go/z650accessories).

### Direct printing with a PictBridge enabled printer

Your camera features PictBridge technology, so you can print directly to PictBridge enabled printers. You need:

- Camera with fully charged batteries, or with optional Kodak 3-volt AC adapter
- PictBridge enabled printer
- USB cable included with your camera

### Connecting the camera to a PictBridge enabled printer

- 1 Turn off the camera and printer.
- 2 Optional: If you have a Kodak 3-volt AC adapter (optional accessory), plug it into the camera and into an electrical outlet.

**IMPORTANT:** *Do not use the AC adapter included with the Kodak EasyShare camera dock or printer dock to power your camera.*

- 3 Connect the USB cable from the camera to the printer. (See your printer user guide for details. See [www.kodak.com/go/z650accessories](http://www.kodak.com/go/z650accessories) to order cables.)

## Printing from a PictBridge enabled printer

- 1 Turn on the printer. Turn on the camera.

*The PictBridge logo is displayed, followed by the current picture and menu. (If no pictures are found, a message is displayed.) If the menu interface turns off, press any button to redisplay it.*

- 2 Press ▲/▼ to choose a printing option, then press the OK button.

**Current Picture**—Press ◀/▶ to choose a picture. Choose the number of copies.

**Tagged Pictures**—If your printer is capable, print pictures that you tagged for printing.

**Index Print**—Print thumbnails of all pictures. This requires one or more sheets of paper. If the printer is capable, choose a print size.

**All Pictures**—Print all pictures in internal memory, on a card, or in Favorites. Choose the number of copies.

**Image Storage**—Access internal memory, a card, or Favorites.

NOTE: During direct printing, pictures are not permanently transferred or saved to the computer or printer. To transfer pictures to your computer, see [page 14](#). In Favorites mode, the current favorite picture is displayed

## Disconnecting the camera from a PictBridge enabled printer

- 1 Turn off the camera and printer.
- 2 Disconnect the USB cable from the camera and the printer.

## **Ordering prints online**

*Kodak EasyShare* Gallery is one of the many online print services offered in EasyShare software. You can easily:

- Upload your pictures.
- Edit, enhance, and add borders to your pictures.
- Store pictures, and share them with family and friends.
- Order high-quality prints, photo greeting cards, frames, and albums—and have them delivered to your door.

## **Printing pictures from your computer**

For details on printing pictures from your computer, see EasyShare software help.

## **Printing from an optional SD or MMC card**

- Automatically print tagged pictures when you insert your card into a printer with an SD/MMC slot. See your printer user's guide for details.
- Make prints at an SD/MMC-capable Kodak picture maker/picture kiosk. (Contact a location prior to visiting. See [www.kodak.com/go/picturemaker](http://www.kodak.com/go/picturemaker).)
- Take the card to your local photo retailer for professional printing.

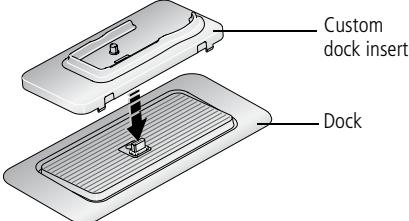
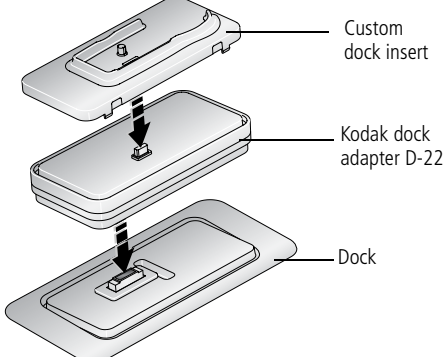

## Dock compatibility for your camera

Dock	Docking configuration
<p>Kodak EasyShare:</p> <ul style="list-style-type: none"> <li>■ printer dock series 3</li> <li>■ camera dock series 3</li> </ul>	 <p>Custom dock insert</p> <p>Dock</p>
<p>Kodak EasyShare:</p> <ul style="list-style-type: none"> <li>■ printer dock</li> <li>■ printer dock plus</li> <li>■ printer dock 6000</li> <li>■ camera dock 6000</li> </ul>	 <p>Custom dock insert</p> <p>Kodak dock adapter D-22</p> <p>Dock</p>
<p>Other docks:</p> <ul style="list-style-type: none"> <li>■ printer dock 4000</li> <li>■ camera dock II</li> <li>■ LS420, LS443 camera dock</li> </ul>	<p>Not compatible</p>

Purchase camera docks, printer docks, and other accessories at a dealer of Kodak products or [www.kodak.com/go/z650accessories](http://www.kodak.com/go/z650accessories).





## 4

# Doing more with your camera

## Changing the flash settings





- 1 Open the flash.
- 2 Press the flash button repeatedly to scroll through flash modes. The current flash mode is depicted in the LCD/EVF status area.

Flash modes	Flash fires		
 <b>Auto Flash</b>	When the lighting conditions require it.		
 <b>Fill</b>	Every time you take a picture, regardless of the lighting conditions. Use when the subject is in shadow or is “backlit” (when light is behind the subject). In low light, hold the camera steady or use a tripod.		
 <b>Red Eye</b>	<table border="0" style="width: 100%;"> <tr> <td style="width: 50%; vertical-align: top;">           If the Red Eye Preflash feature is turned off:           <ul style="list-style-type: none"> <li>■ The flash fires once.</li> <li>■ The camera then automatically corrects red eye in the picture.</li> </ul> </td> <td style="width: 50%; vertical-align: top;">           If the Red Eye Preflash feature is turned on:           <ul style="list-style-type: none"> <li>■ The flash fires once so the eyes become accustomed to the flash, then fires again when the picture is taken.</li> </ul> </td> </tr> </table> <p>To turn the Red Eye Preflash feature on/off, see <a href="#">page 33</a>.</p>	If the Red Eye Preflash feature is turned off: <ul style="list-style-type: none"> <li>■ The flash fires once.</li> <li>■ The camera then automatically corrects red eye in the picture.</li> </ul>	If the Red Eye Preflash feature is turned on: <ul style="list-style-type: none"> <li>■ The flash fires once so the eyes become accustomed to the flash, then fires again when the picture is taken.</li> </ul>
If the Red Eye Preflash feature is turned off: <ul style="list-style-type: none"> <li>■ The flash fires once.</li> <li>■ The camera then automatically corrects red eye in the picture.</li> </ul>	If the Red Eye Preflash feature is turned on: <ul style="list-style-type: none"> <li>■ The flash fires once so the eyes become accustomed to the flash, then fires again when the picture is taken.</li> </ul>		
 <b>Off</b>	Never		

For flash settings in each mode, see [page 55](#).

## Using the self-timer



- 1 Place camera on a tripod or flat surface.
- 2 In any Still mode, press :
  - Once for a 10-sec. delay (so you have time to get into the scene)
  - Again for a 2-sec. delay (for a steady, shutter release on a tripod)
  - Again for 2 pictures (after a 10- and 18-second delay)
- 3 Compose the scene.
- 4 Press the Shutter button halfway, then completely down.



The picture is taken after the delay.

To cancel the Self-timer before the picture is taken, press the Self-timer button. (The Self-timer setting remains active.)





### Use the same procedure to take a video, but:

- Turn the Mode dial to Video .
- Press the Shutter button completely down.

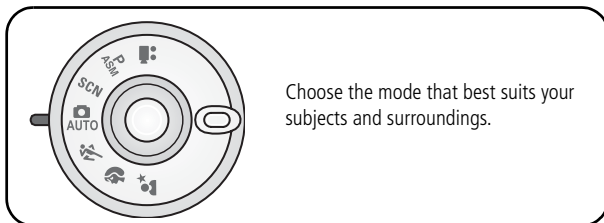
NOTE: The video stops when no storage space remains. Only the 2- and 10-second options are available in video mode.

## Capture modes



Use this mode	For
 <b>Auto</b> AUTO	General picture-taking—offers an excellent balance of image quality and ease of use.
 <b>Sport</b>	Subjects that are in motion. Shutter speed is fast. The camera pre-settings are f/2.8–f/3.7, Multi-Pattern Exposure Metering, Multi-Zone Focus, ISO 100–ISO 200.
 <b>Portrait</b>	Full-frame portraits of people. Allows the subject to be sharp and the background to be indistinct. For best results, position your subject at least 6 ft (2 m) away and fill the frame with a head and shoulder pose. Use Telephoto to exaggerate background blur. The camera pre-settings are f/2.8–f/3.7, Multi-Pattern Exposure Metering, Multi-Zone Focus, ISO 100.
 <b>Night</b>	Use at night to capture subject and background.
<b>SCN</b> <b>Scene</b>	Point-and-shoot simplicity when taking pictures under 14 special conditions. (See <a href="#">Scene modes, page 23.</a> )
 <b>Video</b>	Capturing video with sound. (See <a href="#">page 6.</a> )

## Scene modes

- 1 Turn the Mode dial to Scene **SCN**.
- 2 Press **◀/▶** to display Scene mode descriptions.

NOTE: If the Scene mode description turns off, press the OK button.

- 3 Press the OK button to choose a Scene mode.

Use this SCN mode	For	Camera pre-settings
<b>Children</b>	Action pictures of children in bright light.	f/2.8–f/3.7, Multi-Pattern Exposure Metering, Multi-Zone Focus
<b>Party</b>	People indoors. Minimizes red eye.	f/2.8–f/3.7, Multi-Pattern Exposure Metering, Multi-Zone Focus, Red Eye Flash
<b>Beach</b>	Bright beach scenes.	f/2.8–f/3.7, +1 Exposure Compensation, Center-Weight Metering, Daylight White Balance, ISO 100
<b>Flower</b>	Close-ups of flowers or other small subjects in bright light.	f/2.8–f/3.7, Macro Focus, Daylight White Balance, Center-Zone Focus, Center-Weight Metering
<b>Fireworks</b>	Flash does not fire. Place the camera on a flat, steady surface or use a tripod.	f/5.6, 2 second exposure, Infinity Focus, Center-Weight Metering, Daylight White Balance, ISO 100
<b>Snow</b>	Bright snow scenes.	f/2.8–f/3.7, +1 Exposure Compensation, Center-Weight Metering, Multi-Zone Focus, ISO 100
<b>Backlight</b>	Subjects that are in shadow or “backlit” (when light is behind the subject).	f/2.8–f/3.7, Multi-Pattern Exposure Metering, Multi-Zone Focus, Fill-Flash, ISO 100
<b>Close-up</b>	Subjects closer than 28 in. (70 cm).	f/2.8–f/3.7, Macro Focus, Center-Weight Metering, Center-Zone Focus, ISO 100



Use this SCN mode	For	Camera pre-settings
<b>Night Portrait</b>	Reduces red eye of people in night scenes or low-light conditions. Place the camera on a flat, steady surface or use a tripod.	f/2.8–f/3.7, Multi-Pattern Exposure Metering, Multi-Zone Focus
<b>Landscape</b>	Distant scenery. Flash does not fire. Auto-focus framing marks (page 7) are not available in Landscape.	f/2.8–f/3.7, Infinity Focus, Multi-Pattern Exposure Metering, Daylight White Balance, ISO 100
<b>Night Landscape</b>	Distant scenery at night. Flash does not fire. Place the camera on a flat, steady surface or use a tripod.	f/2.8–f/3.7, Infinity Focus, Daylight White Balance, Center-Weight Metering, Daylight White Balance, ISO 100
<b>Manner/Museum</b>	Quiet occasions, like a wedding or lecture. Flash and sound are disabled. Place the camera on a flat, steady surface or use a tripod.	f/2.8–f/3.7, no sounds, no flash, Multi-Pattern Exposure Metering, Multi-Zone Focus, ISO 100
<b>Text</b>	Documents. Place the camera on a flat, steady surface or use a tripod.	f/2.8–f/3.7, Macro Focus, +1 Exposure Compensation, Center-Weight Metering
<b>Self-Portrait</b>	Close-ups of yourself. Assures proper focus and minimizes red eye.	f/2.8, Macro Focus, Multi-Pattern Exposure Metering, Multi-Zone Focus, Red Eye Flash, ISO 100

For information on PASM modes, see [page 37](#).

## Taking close-up and landscape pictures

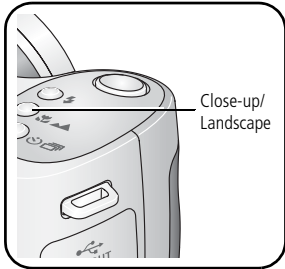
Use the Close-up/Landscape button  to take pictures of scenes that are very close or very far away.



- 1 Set the Mode dial to Auto or a PASM mode. (For PASM mode, see [page 37](#).)
- 2 Press the Close-up/Landscape button  repeatedly until the  or  icon appears in the status bar.
- 3 Take a picture.

NOTE: After you take the picture, the camera stays in the Close-up or Landscape setting. To exit, press the Close-up/Landscape button until the icon turns off (or turn off the camera).

### Close-up pictures



Use the Close-up setting  to gain sharpness and detail in pictures at close range. Use available light instead of flash if possible. The camera automatically sets the focus distance depending on the zoom position:

Zoom position	Close-up focus distance
Wide angle	4.7–27.6 in. (12–70 cm)
Telephoto	3.9–6.9 ft (1.2–2.1 m)

### Landscape pictures

Use the Landscape setting  to gain sharpness of far away scenes. With this setting, the camera uses infinity auto-focus. Auto-focus framing marks are not available in Landscape.

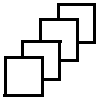
## Using burst

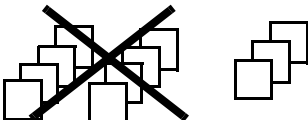
Option	Description	Purpose
 <p><b>First Burst</b></p>	<p>Camera takes up to 4 pictures (2 per second) while the Shutter button is pressed.</p>  <p>First 4 pictures are saved.</p>	<p>Capture an expected event.</p> <p><b>Example:</b> A person swinging a golf club.</p>
 <p><b>Last Burst</b></p>	<p>Camera takes up to 30 pictures (2 per second for up to 15 seconds) while the Shutter button is pressed. When the Shutter button is released, only the last 3 pictures are saved.</p>  <p>Last 3 pictures are saved.</p>	<p>Capture an event when the precise timing is uncertain.</p> <p><b>Example:</b> A child blowing out birthday candles.</p>

- 1 In most Still modes, press the Burst button repeatedly to choose an option.
- 2 Press the Shutter button **halfway** to focus and set exposure.
- 3 Press the Shutter button **completely down and hold it** to take pictures.

*The camera stops taking pictures when you release the Shutter button, when the pictures are taken, or when there is no more storage space.*

NOTE: During Quickview, you can delete all pictures in the burst series. To delete selectively, do so in Review (see [page 11](#)).

## Running a slide show

Use the Slide Show to display your pictures and videos on the LCD. To run a slide show on a television or on any external device, see [page 28](#). To save battery power, use an optional Kodak 3-volt AC adapter. (Visit [www.kodak.com/go/z650accessories](http://www.kodak.com/go/z650accessories).)



## Starting the slide show

- 1 Press the Review button, then press the Menu button.
- 2 Press  $\blacktriangle/\blacktriangledown$  to highlight Slide Show , then press the OK button.
- 3 Press  $\blacktriangle/\blacktriangledown$  to highlight Begin Show, then press the OK button.  
*Each picture and video is displayed once.*

To interrupt the Slide Show, press the OK button.

## Changing the slide show display interval

The default interval setting displays each picture for 5 seconds. You can set the display interval from 3 to 60 seconds.

- 1 On the Slide Show menu, press  $\blacktriangle/\blacktriangledown$  to highlight Interval, then press the OK button.
- 2 Select a display interval.
- 3 To scroll through the seconds quickly, press and hold  $\blacktriangle/\blacktriangledown$ .
- 4 Press the OK button.  
*The interval setting remains until you change it.*

## Running a continuous slide show loop

When you turn on Loop, the slide show is continuously repeated.

- 1 On the Slide Show menu, press  $\blacktriangle/\blacktriangledown$  to highlight Loop, then press the OK button.
- 2 Press  $\blacktriangle/\blacktriangledown$  to highlight On, then press the OK button.  
*The slide show repeats until you press the OK button or until battery power is exhausted. The Loop feature remains until you change it.*

## Displaying pictures and videos on a television

You can display pictures and videos on a television, computer monitor, or any device equipped with a video input. (Image quality on a television screen may not be as good as on a computer monitor or when printed.)

NOTE: Ensure that the Video Out setting (NTSC or PAL) is correct (see [page 33](#)).

- 1 Connect the audio/video cable (included) from the camera A/V Out/USB port to the television video-in port (yellow) and audio-in port (white). See your television user's guide for details.
- 2 Review pictures and videos on the television.

## Changing picture-taking settings

You can change settings to get the best results from your camera:

- 1 Press the Menu button. (Some settings are unavailable in some modes.)
- 2 Press **▲/▼** to highlight a setting, then press the OK button.
- 3 Choose an option, then press the OK button.
- 4 Press the Menu button to exit.

Setting	Options
<b>Picture Size</b> Choose a picture resolution. <i>This setting remains until you change it.</i>	<b>6.0 MP (default)</b> —for printing up to 20 x 30 in. (51 x 76 cm); highest resolution and largest file size. <b>5.3 MP (3:2)</b> — ideal for printing 4 x 6 in. (10 x 15 cm) prints without cropping. Also for printing up to 20 x 30 in. (51 x 76 cm) <b>4.0 MP</b> — for printing up to 20 x 30 in. (51 x 76 cm); medium resolution with smaller file size. <b>3.1 MP</b> —for printing up to 11 x 14 in. (28 x 36 cm); medium resolution with smaller file size. <b>1.7 MP</b> —for printing 4 x 6 in. (10 x 15 cm) prints, emailing, Internet, screen display, or for conserving space.





Setting	Options
<p><b>Video Size</b> Choose a video resolution. Available only in Video mode. <i>This setting remains until you change it.</i></p>	<p><b>640 x 480</b>—higher resolution and file size; video plays in a 640 x 480 pixel window (VGA). <b>320 x 240</b>—lower resolution and file size; video plays in a 320 x 240 pixel window (QVGA).</p>
<p><b>White Balance</b> Choose your lighting condition. <i>This setting remains until you turn the Mode dial or turn off the camera.</i> Available only in PASM mode.</p>	<p><b>Auto (default)</b>—automatically corrects white balance. Ideal for general picture taking. <b>Daylight</b>—for pictures in natural lighting. <b>Tungsten</b>—corrects the orange cast of household light bulbs. Ideal for indoor pictures under tungsten or halogen lighting without flash. <b>Fluorescent</b>—corrects the green cast of fluorescent lighting. Ideal for indoor pictures under fluorescent lighting without flash. <b>Open Shade</b>—for pictures in the shade in natural lighting.</p>
<p><b>Exposure Metering</b> Evaluate light levels at specific areas of a scene. <i>This setting remains until you turn the Mode dial or turn off the camera.</i> Available only in PASM mode.</p>	<p><b>Multi-pattern (default)</b>—evaluates lighting conditions throughout the image to give an optimum picture exposure. Ideal for general picture taking. <b>Center-weight</b>—evaluates the lighting conditions of the subject centered in the viewfinder. Ideal for backlit subjects. <b>Center-spot</b>—similar to Center-weight, except the metering is concentrated on a smaller area of the subject centered in the viewfinder. Ideal when you need an exact exposure of a specific area in the picture.</p>
<p><b>Focus Zone</b> Select a large or concentrated area of focus. <i>This setting remains until you turn the Mode dial or turn off the camera.</i> Available only in PASM mode.</p>	<p><b>Multi-zone (default)</b>—evaluates 3 zones to give an even picture focus. Ideal for general picture taking. <b>Center-zone</b>—evaluates the small area centered in the viewfinder. Ideal when precise focus of a specific area in the picture is needed. For the best pictures, the camera is set to Multi-zone when in Landscape mode.</p>

Setting	Options
<p><b>AF Control</b> Choose an auto-focus setting. <i>This setting remains until you change it.</i></p>	<p><b>Continuous AF (default)</b>—uses external AF sensor and TTL-AF (Through-The-Lens). Because the camera is always focusing, there is no need to press the Shutter button halfway down to focus.</p> <p><b>Single AF</b>—uses external AF sensor and TTL-AF when the Shutter button is pressed halfway down.</p>
<p><b>Color Mode</b> Choose color tones. <i>This setting remains until you turn the Mode dial or turn off the camera.</i> Unavailable in Video mode.</p>	<p><b>High Color</b> <b>Natural Color (default)</b> <b>Low Color</b> <b>Black &amp; White</b> <b>Sepia</b> for pictures with a reddish-brown, antique look. EasyShare software also lets you change a color picture to black-and-white or sepia.</p>
<p><b>Sharpness</b> Control picture sharpness. <i>This setting remains until you change it.</i> Available only in PASM mode.</p>	<p><b>High</b> <b>Normal (default)</b> <b>Low</b></p>
<p><b>Reset to Default</b> Reset P, A, S, or M mode to its default setting. Available only in PASM mode.</p>	
<p><b>Set Album</b> Choose Album names. <i>This setting remains until you change it. You can apply different Set Album choices to videos and to pictures.</i></p>	<p><b>On or Off.</b> Pre-select album names before you take pictures or videos. Then, all the pictures or videos you take are tagged with those album names. (See <a href="#">page 39</a>.)</p>

Setting	Options
<b>Video Length</b> Choose a video length. Available only in Video mode. <i>This setting remains until you change it.</i>	<b>Continuous (default)</b> <b>5, 15, 30 seconds</b>
<b>Image Storage</b> Choose a storage location for pictures and videos. <i>This setting remains until you change it.</i>	<b>Auto (default)</b> —the camera uses the card if one is in the camera. If not, the camera uses internal memory. <b>Internal Memory</b> —the camera always uses internal memory, even if a card is installed.
<b>Setup Menu</b> Choose additional settings.	See <a href="#">Customizing your camera</a> .

## Customizing your camera

Use Setup to customize your camera settings.

- 1 In any mode, press the Menu button.
- 2 Press / to highlight Setup , then press the OK button.
- 3 Press / to highlight the setting you wish to change, then press the OK button.
- 4 Choose an option, then press the OK button.
- 5 Press the Menu button to exit.

Setting	Options
<b>Return</b> to previous menu.	
<b>Quickview</b> Change Quickview default to on or off.	<b>On</b> <b>Off (default)</b>

Setting	Options
<p><b>Advanced Digital Zoom</b> Choose how digital zoom is employed.</p>	<p><b>Continuous</b>—no pause between optical and digital zoom.  <b>Pause (default)</b>—after reaching 10X optical zoom, the zoom button must be released, then activated again to begin digital zoom.  <b>None</b>—digital zoom is disabled.</p>
<p><b>Print Warning</b></p>	<p><b>Pause (default)</b>—when the slider on the zoom indicator pauses during digital zoom, the zoom must be released and reactivated. The slider turns red when the picture may not render an acceptable 4 x 6 in. (10 x 15 cm) print.  <b>None</b>—no pause.</p>
<p><b>Sound Themes</b></p>	<p><b>Shutter only</b>  <b>Default</b>  <b>Classical</b>  <b>Jazz</b>  <b>Sci-fi</b></p>
<p><b>Sound Volume</b></p>	<p><b>Off</b>  <b>Low (default)</b>  <b>Medium</b>  <b>High</b></p>
<p><b>Mode Description</b> Display description when entering a mode.</p>	<p><b>On (default)</b>  <b>Off</b></p>
<p><b>Auto Power Off</b> Choose amount of inactivity time until camera turns off.</p>	<p><b>10 minutes</b>  <b>5 minutes</b>  <b>3 minutes (default)</b>  <b>1 minute</b></p>
<p><b>Date &amp; Time</b></p>	<p>See <a href="#">page 3</a>.</p>

Setting	Options
<p><b>Video Out</b> Choose the regional setting that lets you connect the camera to a television or other external device.</p>	<p><b>NTSC (default)</b>—used in North America and Japan; most common format. <b>PAL</b>—used in Europe and China.</p>
<p><b>Orientation Sensor</b> Orient pictures so that they are displayed with the correct side up.</p>	<p><b>On (default)</b> <b>Off</b></p>
<p><b>Date Stamp</b> Imprint the date on pictures.</p>	<p>Choose a date option, or turn off the feature. (Default is off.)</p>
<p><b>Red Eye Preflash</b> Choose if the Red Eye flash fires automatically before a picture is taken. NOTE: The camera automatically corrects red eye, even if the Red Eye Preflash is set to Off.</p>	<p><b>On</b> <b>Off (default)</b></p>
<p><b>Video Date Display</b> Display Date/Time at the start of video playback.</p>	<p><b>None (default)</b> <b>Choose a date/time format</b></p>
<p><b>Language</b> Choose your language.</p>	
<p><b>Format</b></p> <p> <b>CAUTION:</b> <b>Formatting internal memory or a card deletes all (including protected) pictures, videos, email addresses, album names, and favorites.</b></p>	<p><b>Memory Card</b>—deletes everything on the card; formats the card. <b>Cancel</b>—exits without making a change. <b>Internal Memory</b>—deletes everything in internal memory including email addresses, album names, and favorites; formats the internal memory.</p>
<p><b>About</b> View camera information.</p>	

## Cropping pictures



- 1 Press Review.
- 2 ◀/▶ for previous/next.
- 3 Press Menu, choose Crop , then press OK.
- 4 Press Telephoto (T) to zoom in, or ◀/▶▶/▶▶ to move the crop box.
- 5 Follow the screen prompts.

*The picture is copied, then cropped. The original picture is saved. A cropped picture cannot be cropped again on the camera.*

Press the Menu button to exit the menu.

## Viewing picture/video information



- 1 Press Review.
- 2 Press Info.
- 3 ◀/▶ for previous/next.

Press the Review button to exit Review.



## Copying pictures and videos

You can copy pictures and videos from a card to internal memory or from internal memory to a card.

### Before you copy, make sure that:

- A card is inserted in the camera.
- The storage location is set to the location **from** which you are copying (see [page 31](#)).

### Copy pictures or videos:

- 1 Press the Review button, then press the Menu button.
- 2 Press  $\blacktriangle/\blacktriangledown$  to highlight Copy  $\blacktriangleright\blacktriangleright$ , then press the OK button.
- 3 Press  $\blacktriangle/\blacktriangledown$  to highlight an option:

**PICTURE or VIDEO**—copies the current picture or video.

**EXIT**—returns to the Review menu.

**ALL**—copies all pictures and videos from one storage location to another.

- 4 Press the OK button.

NOTE: Pictures and videos are copied, not moved. To remove pictures from the original location after copying, delete them (see [page 13](#)). Tags that you applied for print, email, and favorites are not copied. Protection settings are not copied. To apply protection to a picture or video, see [page 13](#).

## Adjusting exposure compensation

Use exposure compensation to make pictures lighter or darker.

- 1 In Auto mode, press ▲/▼.

*Exposure compensation information appears on the LCD or EVF. (To change exposure compensation in P, A, S, and M modes, see [page 37](#).)*

- 2 To make pictures lighter, press ▲.

To make pictures darker, press ▼.

*The setting remains until you change it or turn off the camera.*

## Using the histogram to view picture brightness

Use the histogram to evaluate the distribution of light before or after you take a picture. If the peak is to the right of the graph, the subject is bright; if it's to the left, the subject is dark. Optimal exposure is achieved when the peak is in the middle of the histogram.

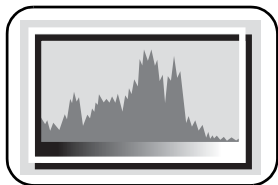

To turn on the histogram in any picture-taking mode or in Review, press the Info **i** button until the histogram appears.

**NOTE:** If a scene is dark or light, you can adjust the exposure compensation before taking the picture. The flash may affect a picture's light and shadow.

## P, A, S, and M modes

Use this mode	For
<b>P</b> Program	Controlling exposure compensation (how much light enters the camera). The camera automatically sets the shutter speed and aperture (f-stop) based on the scene lighting. Program mode offers the ease of auto shooting with full access to all menu options. Press $\blacktriangleleft/\blacktriangleright$ $\blacktriangleup/\blacktriangledown$ to select settings. Press the Menu button to change other settings. (See <a href="#">page 38</a> .)
<b>A</b> Aperture Priority	Controlling aperture, exposure compensation, and ISO speed. Aperture priority mode is primarily used to control depth of field (the range of sharpness).  NOTE: The aperture setting may be affected when using optical zoom. Press $\blacktriangleleft/\blacktriangleright$ $\blacktriangleup/\blacktriangledown$ to select settings. Press the Menu button to change other settings. (See <a href="#">page 38</a> .)
<b>S</b> Shutter Priority	Controlling the shutter speed, exposure compensation, and ISO speed. The camera automatically sets the aperture for proper exposure. Shutter priority mode is primarily used to prevent blur when your subject is moving. To prevent camera shake, use a tripod for slow shutter speeds. Press $\blacktriangleleft/\blacktriangleright$ $\blacktriangleup/\blacktriangledown$ to select settings. Press the Menu button to change other settings. (See <a href="#">page 38</a> .)
<b>M</b> Manual	The highest level of creative control. You set the aperture, shutter speed, and ISO speed. Exposure compensation acts as an exposure meter, recommending the proper combination of aperture and shutter speed to produce an acceptable exposure. To prevent camera shake, use a tripod for slow shutter speeds. Press $\blacktriangleleft/\blacktriangleright$ $\blacktriangleup/\blacktriangledown$ to select settings. Press the Menu button to change other settings. (See <a href="#">page 38</a> .)

NOTE: Settings you change in P, A, S, or M modes apply only to pictures taken in those modes. For example, if you change the Color Mode to Sepia while in P, A, S, or M mode, you retain the default setting of Color for Auto and Scene modes.

The settings, including Flash, are maintained for P, A, S, and M modes—even when you change modes or turn off the camera. Use Reset to Default to reset P, A, S, or M, mode to its default setting. (See [page 30](#)).

## Changing P, A, S, or M mode settings

PASM modes control the aperture (f-number, also known as f-stop), shutter speed, and exposure compensation. Use the Menu button to control all other settings.

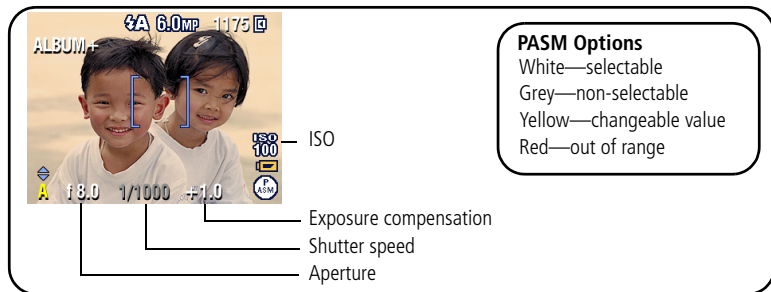

- 1 Turn the Mode dial to PASM.  
*The mode options are displayed.*
- 2 Press  $\blacktriangle/\blacktriangledown$  to choose P, A, S, or M.
- 3 Press  $\blacktriangle/\blacktriangledown$   $\blacktriangle/\blacktriangledown$  to move between settings, open a setting, or change a setting.
- 4 Take a picture.

**Exposure Compensation**—adjust the exposure; good for controlling backlit or non-standard scenes. If the picture is too light, decrease the setting; if it's too dark, increase the setting.

**Shutter speed**—control how long the shutter stays open. A shaking hand icon  warns of slow shutter speeds. (Use a tripod for slow shutter speeds.)

**Aperture**—(also known as f-stop) control the size of the lens opening, which determines the depth of field. Smaller f-numbers indicate a larger lens opening. Larger f-numbers indicate a smaller lens opening. Larger f-numbers keep the main subject sharp; good for landscapes and well-lit conditions. Smaller f-numbers are good for portraits and low-light conditions.



## Pre-tagging for album names

Use the Set Album (Still or Video) feature to pre-select album names before you take pictures or videos. Then, all the pictures or videos you take are tagged with those album names.

### First—on your computer

Use Kodak EasyShare software (V 3.0 or higher, see [page 14](#)) to create album names on your computer. Then copy up to 32 album names to the album name list the next time you connect the camera to the computer. See EasyShare software help for details.

### Second—on your camera

- 1 In any mode, press the Menu button.
- 2 Press  to highlight Set Album , then press the OK button.
- 3 Press  to highlight an album name, then press the OK button. Repeat to mark pictures or videos for albums.

*Selected albums are noted with a check mark.*

- 4 To remove a selection, highlight an album name and press the OK button. To remove all album selections, select Clear All.
- 5 Highlight Exit, then press the OK button.

*Your selections are saved. If you turn on the LCD, your album selection is displayed on the screen. A plus (+) after the album name means more than one album is selected.*

- 6 Press the Menu button to exit the menu.

### Third—transfer to your computer

When you transfer the tagged pictures or videos to your computer, Kodak EasyShare software opens and categorizes your pictures/videos in the appropriate album. See EasyShare software Help for details.

## Tagging pictures/videos for albums

Use the Album feature in Review mode to tag the pictures and videos in your camera with album names.

### First—on your computer

Use Kodak EasyShare software to create album names on your computer, then copy up to 32 album names to the camera's internal memory. See EasyShare software Help for details.

### Second—on your camera

- 1 Press the Review button, then ◀/▶ for previous/next picture or video.
- 2 Press the Menu button.
- 3 Press ▲/▼ to highlight Album , then press the OK button.
- 4 Press ▲/▼ to highlight an album folder, then press the OK button.

To add other pictures/videos to the same album, press ◀/▶ to scroll through the pictures. When the picture/video you want is displayed, press the OK button.

To add the pictures/videos to more than one album, repeat step 4 for each album.

*The album name appears with the picture/video. A plus (+) after the album name means the picture/video was added to more than one album.*

To remove a selection, highlight an album name and press the OK button. To remove all album selections, select Clear All.

### Third—transfer to your computer

When you transfer the tagged pictures/videos to your computer, Kodak EasyShare software opens and categorizes your pictures/videos in the appropriate album. See EasyShare software Help for details.

## Sharing your pictures

Press the Share button to “tag” your pictures and videos. When they are transferred to your computer, you can share them.

- Any time. (The most recent picture/video taken is then displayed.)
- Just after you take a picture/video, during Quickview.
- After pressing the Review button (see [page 11](#)).

## Tagging pictures for printing

1 Press the Share button. Press ◀/▶ for previous/next picture.

2 Press ▲/▼ to highlight Print , then press the OK button.\*

3 Press ▲/▼ to select the number of copies (0-99).

*The Print icon  appears in the status area. The default quantity is one.*

4 **Optional:** You can apply a print quantity to other pictures. Press ◀/▶ for previous/next picture. Keep the print quantity as is, or press ▲/▼ to change it. Repeat this step until the desired print quantity is applied to the pictures.

5 Press the OK button. Then press the Share button to exit the menu.

\* To tag all pictures in the storage location, highlight Print All, press the OK button, then indicate the number of copies. Print All is not available in Quickview. To remove printing tagging for all pictures in the storage location, highlight Cancel Prints, then press the OK button. Cancel Prints is not available in Quickview.

## Printing tagged pictures

When you transfer the tagged pictures to your computer, the EasyShare software print screen opens. For details on printing, see EasyShare software Help.

For more information on printing from your computer, printer dock, PictBridge enabled printer, or card, see [page 16](#).

NOTE: For the best 4 x 6 in. (10 x 15 cm) prints, set the camera to the 5.3 MP (3:2) picture size setting. (See [page 28](#).)

## Tagging pictures and videos for emailing

### First—on your computer

Use Kodak EasyShare software to create an email address book on your computer. Then, copy up to 32 email addresses to the camera's internal memory. For details, see EasyShare software help.

### Second—tag pictures/videos on your camera

1 Press the Share button. Press ◀/▶ for previous/next picture/video.

2 Press ▲/▼ to highlight Email , then press the OK button.

*The Email icon  appears in the status area.*

3 Press ▲/▼ to highlight an email address, then press the OK button.

To tag other pictures/videos with the same address, press ◀/▶ to scroll through them. When the picture you want is displayed, press OK.

To send the pictures/videos to more than one address, repeat step 3 for each address.

*Selected addresses are checked.*

4 To remove a selection, highlight a checked address and press the OK button. To remove all email selections, highlight Clear All.

5 Press ▲/▼ to highlight Exit, then press the OK button.

*The Email icon  appears in the status area.*

6 Press the Share button to exit the menu.

### Third—transfer and email











When you transfer the tagged pictures/videos to your computer, the Email screen opens and lets you send them to the addresses you specified. For details, see EasyShare software Help.



## Tagging pictures as favorites

You can preserve your favorite pictures in the Favorites  section of your camera's internal memory, then share them with friends and family.





NOTE: When you transfer pictures from your camera to your computer, all pictures (including favorites) are stored on your computer at full size. Favorite pictures—smaller copies of your originals—are loaded back to your camera, so you can share and enjoy more.

<p><b>1. Tag pictures as favorites</b></p> 	<ol style="list-style-type: none"> <li>1 Press the Share button. Press   for previous/next picture.</li> <li>2 Press   to highlight Favorite , then press the OK button. <i>The Favorite icon  appears in the status area. To remove the tag, press the OK button again.</i></li> </ol> <p>Press the Share button to exit the menu.</p>
<p><b>2. Transfer pictures to your computer</b></p>	<ol style="list-style-type: none"> <li>1 To enjoy full functionality, load and use the EasyShare software that was packaged with this camera. (See <a href="#">page 14</a>.)</li> <li>2 Connect the camera to the computer using the USB cable (see <a href="#">page 15</a>) or an EasyShare dock. <i>The first time you transfer pictures, the software helps you make choices about your favorite pictures. Then, your pictures are transferred to the computer. Favorite pictures (smaller versions of the originals) are loaded to the Favorites section of your camera's internal memory.</i></li> </ol>
<p><b>3. View favorites on your camera</b></p> 	<ol style="list-style-type: none"> <li>1 Move the Power/Favorites switch to Favorites .</li> <li>2 Press   to scroll through favorites.</li> </ol>

NOTE: The camera holds a limited number of favorites. Use Camera Favorites in the EasyShare software to customize the size of your camera Favorites  section. Videos tagged as favorites remain in the Favorites folder in the EasyShare software. For more information, see EasyShare software Help.



## Optional settings

In Favorites mode, press the Menu button to access optional settings.

	Slide Show ( <a href="#">page 26</a> )		Remove all favorites ( <a href="#">Removing all favorites from your camera, page 44</a> )
	Multi-up ( <a href="#">page 12</a> )		Setup Menu ( <a href="#">page 31</a> )
	Picture Information ( <a href="#">page 34</a> )		

NOTE: Pictures taken at the 5.3 MP (3:2) picture size are displayed at a 3:2 aspect ratio with a black bar at the top of the screen. (See [page 28](#).)

## Removing all favorites from your camera

- 1 Move the Power/Favorites switch to Favorites .
- 2 Press the Menu button.
- 3 Highlight , then press the OK button.

*All pictures stored in the Favorites section of internal memory are removed. Favorites are restored the next time you transfer pictures to the computer.*





- 4 Press the Menu button to exit the menu.

## Preventing favorites from transferring to the camera

- 1 Open the Kodak EasyShare software. Click the My Collection tab.
- 2 Go to the Albums view.
- 3 Click the Camera Favorites Album for your camera.
- 4 Click Remove Album.

*The next time you transfer pictures from your camera to the computer, use the Camera Favorites Wizard/Assistant to either recreate your Camera Favorites Album or to turn off the Camera Favorites feature.*

## Printing and emailing favorites

- 1 Move the Power/Favorites switch to Favorites . Press  for previous/next picture.
- 2 Press the Share button.
- 3 Highlight Print  or Email , then press the OK button.

NOTE: Favorites that were taken on this camera (not imported from another source) are good for prints up to 4 x 6 in. (10 x 15 cm).

## 5

# Troubleshooting

## Camera problems

For step-by-step product support, visit [www.kodak.com/go/z650support](http://www.kodak.com/go/z650support) and select Interactive Troubleshooting & Repairs.

If...	Try one or more of the following
Camera does not turn on	<ul style="list-style-type: none"> <li>■ Insert a new or charged battery.</li> <li>■ Connect the camera to a Kodak 3-volt AC adapter (sold separately), then try again. See <a href="#">page 60</a> for more battery information.</li> </ul>
Camera does not turn off and the lens does not retract	
Camera buttons and controls do not function	
Lens does not extend when camera turns on or does not retract	<ul style="list-style-type: none"> <li>■ Confirm that the battery in camera is charged.</li> <li>■ Turn camera off, then on again. (Lens does not extend in Favorites mode.)</li> <li>■ If problem still exists, get help (<a href="#">page 51</a>).</li> </ul>
EVF/LCD is black or does not turn on	<ul style="list-style-type: none"> <li>■ Remove the lens cap.</li> <li>■ Push the EVF/LCD button to change the display.</li> </ul>
In Review, a blue or black screen is displayed instead of a picture	<ul style="list-style-type: none"> <li>■ Transfer the picture to the computer.</li> <li>■ Transfer <i>all</i> pictures to the computer (<a href="#">page 15</a>).</li> <li>■ Take another picture. If problem continues, try internal memory and/or another memory card.</li> </ul>
Pictures remaining number does not decrease after taking a picture	<ul style="list-style-type: none"> <li>■ Continue taking pictures. The camera is operating normally. (The camera estimates the number of pictures remaining after each picture is taken, based on picture size and content.)</li> </ul>

If...	Try one or more of the following
Picture orientation is not accurate	<ul style="list-style-type: none"> <li>■ Set the Orientation Sensor to ON (see <a href="#">page 33</a>).</li> </ul>
Flash does not fire	<ul style="list-style-type: none"> <li>■ Open the flash unit (<a href="#">page 9</a>).</li> <li>■ Check the flash setting and change as needed (<a href="#">page 20</a>).</li> </ul> <p>NOTE: The flash does not fire in all modes.</p>
Storage location is almost or entirely full	<ul style="list-style-type: none"> <li>■ Transfer pictures to the computer (<a href="#">page 15</a>).</li> <li>■ Delete pictures from the card (<a href="#">page 13</a>) or insert a new one.</li> <li>■ Change image storage location to internal memory (<a href="#">page 31</a>).</li> </ul>
Battery life is short	<ul style="list-style-type: none"> <li>■ Make sure the correct battery type is installed (<a href="#">page 60</a>).</li> <li>■ Wipe the contacts with a clean, dry cloth before inserting a battery in the camera.</li> <li>■ Insert a new or charged battery (<a href="#">page 2</a>).</li> </ul>
You cannot take a picture	<ul style="list-style-type: none"> <li>■ Turn camera off, then on again. Make sure the camera is not in Favorites mode.</li> <li>■ Press Shutter button all the way (<a href="#">page 5</a>).</li> <li>■ Insert a new or charged battery (<a href="#">page 2</a>).</li> <li>■ Wait until the AF/AE indicator turns green before attempting to take another picture.</li> <li>■ Memory full. Transfer pictures to the computer (<a href="#">page 15</a>), delete pictures (<a href="#">page 13</a>), change image storage location (<a href="#">page 31</a>), or insert another card.</li> </ul>
Error message appears on EVF/LCD	<ul style="list-style-type: none"> <li>■ Turn the camera off, then on again.</li> <li>■ Remove memory card from the camera.</li> <li>■ Remove the battery and wipe the contacts with a clean, dry cloth.</li> <li>■ Insert a new or charged battery (<a href="#">page 2</a>).</li> <li>■ Get customer support help (<a href="#">page 51</a>).</li> </ul>
Memory card not recognized or camera freezes with card.	<ul style="list-style-type: none"> <li>■ Card may be corrupted. Format card in camera (see <a href="#">page 33</a>).</li> <li>■ Use another memory card.</li> </ul>

## Computer/connectivity problems

If...	Try one or more of the following
Computer does not communicate with the camera	<ul style="list-style-type: none"> <li>■ Insert a charged battery (<a href="#">page 2</a>).</li> <li>■ Turn on the camera.</li> <li>■ Make sure proper USB cable is connected on camera and computer port (<a href="#">page 15</a>). (If using an EasyShare dock, check all cable connections. Make sure the camera is seated on the dock.)</li> <li>■ Make sure the EasyShare software is installed (<a href="#">page 14</a>).</li> </ul>
Pictures do not transfer to computer	<ul style="list-style-type: none"> <li>■ Click the Help button in the EasyShare software.</li> </ul>
Slide Show does not run on an external video device	<ul style="list-style-type: none"> <li>■ Adjust the camera Video Out setting (see <a href="#">page 33</a>).</li> <li>■ Make sure the external device settings are correct (see the device's user's guide).</li> </ul>

## Picture quality problems

If...	Try one or more of the following
Picture is too dark	<ul style="list-style-type: none"> <li>■ Reposition camera for more available light.</li> <li>■ Use Fill flash (<a href="#">page 20</a>) or change your position so light is not behind the subject.</li> <li>■ Move so that the distance between you and the subject is within the effective flash range (<a href="#">page 9</a>).</li> <li>■ To automatically set exposure and focus, press the Shutter button <b>halfway</b>. When the AF/AE indicator turns green, press the Shutter button <b>completely down</b> to take the picture.</li> <li>■ Adjust exposure compensation (<a href="#">page 36</a>).</li> </ul>

If...	Try one or more of the following
Picture is too light	<ul style="list-style-type: none"> <li>■ Reposition camera to reduce the amount of available light.</li> <li>■ Turn flash off (<a href="#">page 9</a>).</li> <li>■ Move so that the distance between you and the subject is within the effective flash range (<a href="#">page 9</a>).</li> <li>■ To automatically set exposure and focus, press the Shutter button <b>halfway</b>. When the AF/AE indicator turns green, press the Shutter button <b>completely down</b> to take the picture.</li> <li>■ Use P mode to adjust the Exposure.</li> </ul>
Picture is not clear	<ul style="list-style-type: none"> <li>■ To automatically set exposure and focus, press the Shutter button <b>halfway</b>. When the AF/AE indicator turns green, press the Shutter button <b>completely down</b> to take the picture.</li> <li>■ Clean the lens (<a href="#">page 61</a>).</li> <li>■ Make sure camera is not in Close-up mode if you are more than 27.6 in. (70 cm) from your subject.</li> <li>■ Place the camera on a flat, steady surface or use a tripod, especially in high-zoom settings or in low light.</li> </ul>

## Direct printing (PictBridge) problems

Status	Solution
Cannot locate desired picture.	<ul style="list-style-type: none"><li>■ Turn on the camera. Make sure the camera is not in Favorites mode.</li><li>■ Use the Direct print menu to change the image storage location.</li></ul>
The Direct print menu interface turns off.	Press any button to redisplay the menu.
Cannot print pictures.	<ul style="list-style-type: none"><li>■ Ensure that there is a connection between camera and printer (<a href="#">page 15</a>).</li><li>■ Ensure the printer and camera have power.</li></ul>
Camera or printer display an error message.	Follow the prompts to resolve the issue.



# 6

## Getting help

### Helpful links

#### Camera

Email Kodak customer support	<a href="http://www.kodak.com/go/z650support">www.kodak.com/go/z650support</a>
Get support for your product (FAQs, troubleshooting information, arrange for repairs, etc.)	<a href="http://www.kodak.com/go/z650support">www.kodak.com/go/z650support</a>
Purchase camera accessories (camera docks, printer docks, lenses, cards, etc.)	<a href="http://www.kodak.com/go/z650accessories">www.kodak.com/go/z650accessories</a>
Download the latest camera firmware and software	<a href="http://www.kodak.com/go/z650downloads">www.kodak.com/go/z650downloads</a>
See online demonstrations of your camera	<a href="http://www.kodak.com/go/howto">www.kodak.com/go/howto</a>

#### Software

Get information on EasyShare software	<a href="http://www.kodak.com/go/easysharesw">www.kodak.com/go/easysharesw</a> (or click Help in EasyShare software)
Get help with the Windows operating system and working with digital pictures	<a href="http://www.kodak.com/go/pcbasics">www.kodak.com/go/pcbasics</a>

#### Other

Get support for other cameras, software, accessories, more	<a href="http://www.kodak.com/go/support">www.kodak.com/go/support</a>
Get information on Kodak EasyShare printer docks	<a href="http://www.kodak.com/go/printerdocks">www.kodak.com/go/printerdocks</a>
Get information on Kodak inkjet products	<a href="http://www.kodak.com/go/inkjet">www.kodak.com/go/inkjet</a>
Optimize your printer for truer, more vibrant colors	<a href="http://www.kodak.com/go/onetouch">www.kodak.com/go/onetouch</a>
Register your camera	<a href="http://www.kodak.com/go/register">www.kodak.com/go/register</a>

## Telephone customer support

If you have questions concerning this product, you may speak with Kodak customer support:

Australia	1800 147 701
Austria	0179 567 357
Belgium	02 713 14 45
Brazil	0800 150000
Canada	1 800 465 6325
China	800 820 6027
Denmark	3 848 71 30
Ireland	01 407 3054
Finland	0800 1 17056
France	01 55 1740 77
Germany	069 5007 0035
Greece	00800 44140775
Hong Kong	800 901 514
India	91 22 617 5823
Italy	02 696 33452
Japan	03 5540 9002
Korea	00798 631 0024

Netherlands	020 346 9372
New Zealand	0800 440 786
Norway	23 16 21 33
Philippines	1 800 1 888 9600
Poland	00800 4411625
Portugal	021 415 4125
Singapore	800 6363 036
Spain	91 749 76 53
Sweden	08 587 704 21
Switzerland	01 838 53 51
Taiwan	0800 096 868
Thailand	001 800 631 0017
Turkey	00800 448827073
United Kingdom	0870 243 0270
United States	1 800 235 6325 585 781 6231 (toll)
International Toll Line	+44 131 458 6714
International Toll Fax	+44 131 458 6962

For the most up-to-date listings, visit: [www.kodak.com/go/dfiswwcontacts](http://www.kodak.com/go/dfiswwcontacts)

## Camera specifications

**CCD**—1/2.5 in. CCD, 4:3 aspect ratio

**Picture size**—

6.0 MP: 2832 x 2128 pixels

5.3 MP (3:2): 2832 x 1888 pixels

4.0 MP: 2304 x 1728 pixels

3.1 MP: 2048 x 1536 pixels

1.7 MP: 1496 x 1122 pixels

**Color display**—2.0 in. (5 cm) color hybrid LCD; 480 x 240 (110 K) pixels

**Color electronic viewfinder**—LCD and EVF (not simultaneous); 0.2 in. (5.1 mm) 201 K pixels

**Preview (LCD/EVF)**—Frame rate: 27 fps

**Taking lens**—10X optical zoom, aspheric all-glass lens, f/2.8–3.7 (35 mm equivalent: 38–380 mm)

**Accessory lens thread**—Yes

**Lens protection**—Lens cap

**Digital zoom**—Combined zoom settings 10.6X to 50X in 0.6X increments. (Not supported for movie capture.)

**Focus system**—TTL-AF; auto, multi-zone, center-spot. (Center-weighted available in PASM modes.) Working range:

24 in. (60 cm)—infinity @ wide

6.6 ft (2 m)—infinity @ telephoto

4.7–27.6 in. (12–70 cm) @ wide close-up

3.9–6.9 ft (1.2–2.1 m) @ telephoto close-up

**Exposure metering**—TTL-AE, Multi-pattern, Center-spot, Center-weighted (available in PASM modes only)

**Exposure compensation**—+/-2.0 EV with 0.5 EV step

**Shutter speed**—

Auto: 1/8–1/1700 sec.

Shutter priority: 1/8–1/2000 sec. @ Wide

Selectable: 0.7–8 sec.

**ISO speed**—

Auto: 80 to 160

Selectable: 80, 100, 200, 400, 800 (800 available only in 1.7 MP picture quality.)

**Electronic flash**—Guide no. 10.6 (@ ISO 100); auto flash with pre-flash control.

Working range @ ISO 168:

2–16 ft (0.6–4.9 m) @ Wide;

6.6–12 ft (2–3.7 m) @ Tele

**Flash modes**—Auto, Fill, Red Eye, Off

**Capture modes**—Auto, Portrait, Sport, Night, Landscape, Close-up, Video, Scene and PASM modes

**Burst mode**—First burst 4 pictures; Last burst 3 pictures; both @ 2.5 FPS (AE, AF, AWB executed for first shot only)

**Video capture**—

VGA (640 x 480) @ 11 FPS

QVGA (320 x 240) @ 20 FPS

**Image file format**—

Still: EXIF 2.2.1 (JPEG compression); file organization DCF

Video: QuickTime (CODEC MPEG-4)

**Image storage**—Optional MMC or SD Card  (The SD logo is a trademark of the SD Card Association.)

**Internal storage capacity**—32 MB internal memory (28 MB available for image storage. 1 MB equals one million bytes.)

**Quickview**—Yes

**Video output**—NTSC or PAL

**Power**—CRV3; 2-AA lithium; 2-AA Ni-MH; Kodak Ni-MH rechargeable digital camera battery (KAA2HR); 3V AC adapter

**Communication with computer**—USB 2.0 (PIMA 15740 protocol), via USB cable (U-8), EasyShare camera dock or printer dock

**PictBridge support**—Yes

**Self-timer**—2 or 10 seconds, or 2-shot

**Sound feedback**—All On, Shutter Only, All Off

**White Balance**—Auto, Daylight, Open Shade, Tungsten, Fluorescent (available only in PASM)

**Color modes**—High Color, Natural Color, Low Color, Black & White

**Date stamp**—None, YYYYMMDD, MMDDYYYY, DDMMYYYY

**Tripod mount**—1/4 inch

**Operating temperature**—32–104° F (0–40° C)

**Size**—3.9 in. (9.78 cm) x 3.1 in. (7.75 cm) x 2.9 in. (7.26 cm) @ power off

**Weight**—10.1 oz (287 g) without card or battery

## Flash settings in each mode

Flash settings are preset for each picture-taking mode.

Capture modes	Default setting	Available settings
Auto	Auto*	Auto, Off, Fill Flash, Red Eye
Sport	Auto*	Auto, Off, Fill Flash, Red Eye
Portrait	Auto*	Auto, Off, Fill Flash, Red Eye

Capture modes	Default setting	Available settings
<b>P, A, S, or M</b>	Auto*	Auto, Off, Fill Flash, Red Eye
<b>Night</b>	Auto*	Auto, Off, Fill Flash, Red Eye
<b>SCN Scene modes</b>		
<b>Children</b>	Auto*	Auto, Off, Fill Flash, Red Eye
<b>Party</b>	Red Eye*	Auto, Off, Fill Flash, Red Eye
<b>Beach</b>	Auto*	Auto, Off, Fill Flash, Red Eye
<b>Flower</b>	Off	Off, Fill Flash
<b>Fireworks</b>	Off	Off
<b>Snow</b>	Auto*	Auto, Off, Fill Flash, Red Eye
<b>Backlight</b>	Fill	Fill
<b>Close-up</b>	Off	Off, Fill Flash
<b>Night Portrait</b>	Red Eye*	Auto, Off, Fill Flash, Red Eye
<b>Landscape</b>	Off	Off
<b>Night Landscape</b>	Off	Off
<b>Manner/Museum</b>	Off	Off
<b>Text</b>	Off	Off, Fill Flash
<b>Self-Portrait</b>	Red Eye*	Auto, Off, Fill Flash, Red Eye
<b>Video</b>	Off	Off
<b>First burst</b>	Off	Off
<b>Last burst</b>	Off	Off

\* When you change to Auto or Red Eye in these modes, it becomes the default until you change it.

## Storage capacities

### Picture storage capacity

File sizes vary. You may be able to store more or fewer pictures and videos. Favorites take up additional space in internal memory.

	Number of pictures				
	6.0 MP	5.3 MP (3:2)	4.0 MP	3.1 MP	1.7 MP
<b>Internal memory</b>	14	16	21	27	46
<b>32 MB SD/MMC</b>	16	18	24	30	51
<b>64 MB SD/MMC</b>	33	37	48	60	103
<b>128 MB SD/MMC</b>	66	74	97	121	208
<b>256 MB SD/MMC</b>	133	149	196	242	416
<b>512 MB SD/MMC</b>	266	298	392	485	832
<b>1 GB SD/MMC</b>	532	596	784	970	1664

## Video storage capacity

	Minutes/seconds of video	
	VGA (640 x 480)	QVGA (320 x 240)
Internal memory	1 min. 47 sec.	3 min. 23 sec.
32 MB SD/MMC	1 min. 52 sec.	3 min. 46 sec.
64 MB SD/MMC	3 min. 59 sec.	7 min. 32 sec.
128 MB SD/MMC	7 min. 59 sec.	15 min. 4 sec.
256 MB SD/MMC	15 min. 58 sec.	30 min. 8 sec.
512 MB SD/MMC	31 min. 57 sec.	60 min. 17 sec.
1 GB SD/MMC	63 min. 54 sec.	120 min. 34 sec.

## Important safety instructions



### CAUTION:

Do not disassemble this product; there are no user-serviceable parts inside. Refer servicing to qualified service personnel. Do not expose this product to liquid, moisture, or extreme temperatures. Kodak AC adapters and battery chargers are intended for indoor use only. The use of controls, adjustments, or procedures other than those specified herein may result in exposure to shock and/or electrical or mechanical hazards. If the LCD breaks, do not touch the glass or liquid. Contact Kodak customer support.

## Using this product

- The use of an accessory attachment that is not recommended by Kodak, such as an AC adapter, may cause fire, electric shock, or injury.
- Use only a USB-certified computer. Contact your computer manufacturer if you have questions.
- If using this product in an airplane, observe all instructions of the airline.



## Battery safety and handling



### CAUTION:

#### **When removing the battery, allow it to cool; it may be hot.**

- Read and follow all warnings and instructions supplied by the battery manufacturer.
- Use only batteries approved for this product to avoid risk of explosion.
- Keep batteries out of the reach of children.
- Do not allow batteries to touch metal objects, including coins. Otherwise, a battery may short circuit, discharge energy, become hot, or leak.
- Do not disassemble, install backward, or expose batteries to liquid, moisture, fire, or extreme temperature.
- Remove the battery when the product is stored for an extended period of time. In the unlikely event that battery fluid leaks inside the product, contact Kodak customer support.
- In the unlikely event that battery fluid leaks onto your skin, wash immediately with water and contact your local health provider. For additional health-related information, contact your local Kodak customer support.
- Dispose of batteries according to local and national regulations.
- Do not charge non-rechargeable batteries.

For more information on batteries, see

[www.kodak.com/global/en/service/batteries/batteryUsage.jhtml](http://www.kodak.com/global/en/service/batteries/batteryUsage.jhtml)

## Battery life

Use these Kodak batteries. (Battery types are also molded into battery door.)

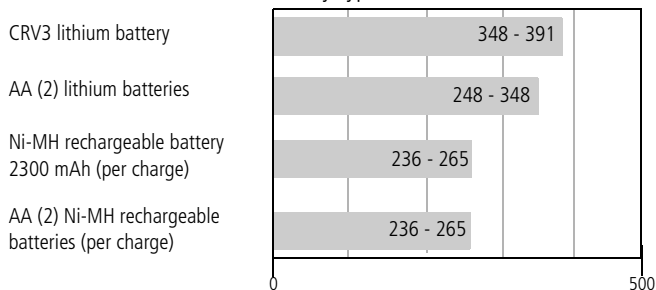

Battery life per CIPA testing method (Approx. number of pictures). Actual life may vary based on usage.

**We do not recommend or support alkaline batteries.** For acceptable battery life, and to make sure your camera operates dependably, use the replacement batteries listed above.

### Extending battery life

- Limit the following activities that quickly deplete battery power:
  - Reviewing your pictures on the LCD
  - Using the LCD as a viewfinder
  - Excessive use of the flash
- Dirt on the battery contacts can affect battery life. Wipe the contacts with a clean, dry cloth before loading batteries in the camera.
- Battery performance is reduced at temperatures below 41° F (5° C). When using your camera in cold weather, carry spare batteries and keep them warm. Do not discard cold batteries that do not work; when they return to room temperature, they may be usable.

## Battery charging options

Visit [www.kodak.com/go/z650accessories](http://www.kodak.com/go/z650accessories) for:

**Kodak EasyShare camera dock series 3**—powers your camera, transfers pictures, and charges the Kodak Ni-MH rechargeable digital camera battery.

**Kodak EasyShare printer dock series 3**—powers your camera, makes 4 x 6-in. (10 x 15 cm) prints with or without a computer, transfers pictures, and charges the Kodak Ni-MH rechargeable digital camera battery.

**Kodak 3-volt AC adapter**—powers your camera.

**IMPORTANT:** *Do not use the AC adapter included with the Kodak EasyShare camera dock or printer dock to power your camera.*

## Upgrading your software and firmware

Download the latest versions of the software included on the Kodak EasyShare software CD and the camera firmware (the software that runs on the camera). See [www.kodak.com/go/z650downloads](http://www.kodak.com/go/z650downloads).

## Additional care and maintenance

- If the camera has been subjected to inclement weather or you suspect water has gotten inside the camera, turn off the camera and remove the batteries and card. Allow components to air-dry for at least 24 hours before using the camera again.
- Blow gently on the lens or LCD to remove dust and dirt. Wipe gently with a soft, lint-free cloth or an untreated lens-cleaning tissue. Do not use cleaning solutions unless designed specifically for camera lenses. Do not allow chemicals, such as suntan lotion, to contact painted surfaces.
- Service agreements are available in some countries. Contact a dealer of Kodak products for more information.
- For digital camera disposal or recycling information, contact your local authorities. In the US, visit the Electronics Industry Alliance Web site at [www.eiae.org](http://www.eiae.org) or the Kodak Web site at [www.kodak.com/go/z650support](http://www.kodak.com/go/z650support).

## Warranty

### Limited warranty

Kodak warrants Kodak EasyShare digital cameras and accessories (excluding batteries) to be free from malfunctions and defects in both materials and workmanship for one year from the date of purchase.

Retain the original dated sales receipt. Proof of the date of purchase will be required with any request for warranty repair.

### Limited warranty coverage

This limited warranty will be honored only within the geographical location that Kodak digital cameras and accessories were purchased.

Kodak will REPAIR or REPLACE Kodak EasyShare digital cameras and accessories if they fail to function properly during the warranty period, subject to any conditions and/or limitations stated herein. Such repair service will include all labor as well as any necessary adjustments and/or replacement parts. Such repair or replacement is the sole remedy under this warranty.

If replacement parts are used in making repairs, these parts may be remanufactured, or may contain remanufactured materials. If it is necessary to replace the entire product, it may be replaced with a remanufactured product.

### Limitations

Request for Warranty service will not be accepted without proof of date of purchase, such as a copy of the original dated Kodak EasyShare digital camera or accessory sales receipt. (Always keep the original for your records.)

This warranty does not apply to the battery(s) used in digital cameras or accessories. This warranty does not cover circumstances beyond Kodak's control, nor problems caused by failure to follow the operating instructions in the Kodak EasyShare digital cameras and accessories User's Guides.

This warranty does not apply when failure is due to shipping damage, accident, alteration, modification, unauthorized service, misuse, abuse, use with incompatible accessories or attachments, failure to follow Kodak's operation, maintenance or repacking instructions, failure to use items supplied by Kodak (such as adapters and cables), or claims made after the duration of this warranty.

Kodak makes no other express or implied warranty for this product. In the event that the exclusion of any implied warranty is ineffective under the law, the duration of the implied warranty will be one year from the purchase date.

The option of replacement is Kodak's only obligation. Kodak will not be responsible for any special, consequential or incidental damages resulting from the sale, purchase, or use of this product, regardless of the cause. Liability for any special, consequential or incidental damages (including but not limited to loss of revenue or profit, downtime costs, loss of the use of the equipment, cost of substitute equipment, facilities or services, or claims of your customers for such damages resulting from the purchase, use or failure of the product), regardless of cause or for breach of any written or implied warranty is expressly disclaimed and excluded herefrom.

## Your rights

Some states or jurisdictions do not allow exclusion or limitation of incidental or consequential damages, so the above limitation or exclusion may not apply to you. Some states or jurisdictions do not allow limitations on how long an implied warranty lasts, so the above limitation may not apply to you.

This warranty gives you specific rights, and you may have other rights which vary from state to state or by jurisdiction.

## Outside the United States and Canada

In countries other than the United States and Canada, the terms and conditions of this warranty may be different. Unless specific Kodak warranty is communicated to the purchaser in writing by a Kodak company, no warranty or liability exists beyond any minimum requirements imposed by law, even though defect, damage, or loss may be by negligence or other act.

## Regulatory compliance

### FCC compliance and advisory



Kodak EasyShare Z650 zoom digital camera

This equipment has been tested and found to comply with the limits for a Class B digital device, pursuant to Part 15 of the FCC Rules. These limits are designed to provide reasonable protection against harmful interference in a residential installation.

This equipment generates, uses, and can radiate radio frequency energy and, if not installed or used in accordance with the instructions, may cause harmful interference to radio communications. However, there is no guarantee that interference will not occur in a particular installation.

If this equipment does cause harmful interference to radio or television reception, which can be determined by turning the equipment off and on, the user is encouraged to try to correct the interference by one or more of the following measures: 1) reorient or relocate the receiving antenna; 2) increase the separation between the equipment and the receiver; 3) connect the equipment to an outlet on a circuit different from that to which the receiver is connected; 4) consult the dealer or an experienced radio/TV technician for additional suggestions.

Any changes or modifications not expressly approved by the party responsible for compliance could void the user's authority to operate the equipment. Where shielded interface cables have been provided with the product or specified additional components or accessories elsewhere defined to be used with the installation of the product, they must be used in order to ensure compliance with FCC regulation.

### Canadian DOC statement

**DOC Class B Compliance**—This Class B digital apparatus complies with Canadian ICES-003.

**Observation des normes-Class B**—Cet appareil numérique de la classe B est conforme à la norme NMB-003 du Canada.

## Waste Electrical and Electronic Equipment labeling



In the European Union, do not discard this product as unsorted municipal waste. Contact your local authorities or go to [www.kodak.com/go/recycle](http://www.kodak.com/go/recycle) for recycling program information.

## VCCI Class B ITE

この装置は、情報処理装置等電波障害自主規制協議会（VCCI）の基準に基づきクラスB情報技術装置です。この装置は、家庭環境で使用することを目的としていますが、この装置がラジオやテレビジョン受信機に近接して使用されると、受信障害を引き起こすことがあります。取扱説明書に従って正しい取り扱いをして下さい。

English translation:

This is a Class B product based on the standard of the Voluntary Control Council for Interference from Information Technology Equipment (VCCI). If this is used near a radio or television receiver in a domestic environment, it may cause radio interference. Install and use the equipment according to the instruction manual.

## Korean Class B ITE

이 기기는 가정용으로 전자파적합등록을 한 기기로서 주거지역에서는 물론 모든 지역에서 사용할 수 있습니다.

## MPEG-4

Use of this product in any manner that complies with the MPEG-4 visual standard is prohibited, except for use by a consumer engaging in personal and non-commercial activities.

---

# Index

## A

- A/V out, 28
- about picture, video, 34
- about this camera, 33
- AC adapter, 61
- accessories, 15
  - AC adapter, 61
  - battery, 60
  - buying, 51
  - camera dock, 61
  - printer dock, 16, 61
  - SD/MMC card, 4
- AF control, 30
- album
  - set, 30
- albums
  - tagging pictures for, 39
- aperture priority, 37
- auto, 22
  - flash, 9
  - focus framing marks, 7

## B

- backlight, 23
- batteries
  - expected life, 60
  - extending life, 60
  - loading, 2
  - safety, 59
  - types, 60
- beach, 23
- burst, using, 26

## button

- burst, 26
- close-up/landscape, i, 25
- delete, ii
- EVF/LCD, ii
- flash, 9
- info, ii
- menu, ii
- power/favorites, i
- review, ii, 11
- self-timer/burst, i
- share, ii
- zoom, ii, 8

## C

- cable
  - audio/video, 28
  - USB, 15
- camera dock, 61
- camera sounds, 32
- Canadian compliance, 64
- caring for your camera, 61
- children, 23
- clock, setting, 3
- close-up
  - scenes, 25
- close-up/landscape button, i
- color mode, 30
- computer
  - connecting camera, 14
  - transfer to, 14
- copy pictures



card to memory, 35  
memory to card, 35  
to computer via USB cable, 14  
cropping pictures, 34  
CRV3 battery, loading, 2  
customer support, 52  
customizing camera settings, 31

## D

date & time, 32  
date setting, 3  
date stamp, 33  
DC-in, i  
delete button, ii  
deleting  
    from internal memory, 13  
    from SD/MMC card, 13  
    protecting pictures, videos, 13  
digital zoom, using, 8  
displaying slide show, 26  
disposal, recycling, 61  
distant scenes, 25  
dock  
    camera, 61  
    connector, ii  
    printer, 16, 61  
downloading pictures, 14

## E

emailing pictures, videos, 42  
EVF (electronic viewfinder), ii  
EVF/LCD button, ii  
expected battery life, 60  
exposure

compensation, 37  
metering, 29  
external video device  
    viewing pictures, videos, 28

## F

favorites  
    removing, 44  
    settings, 44  
    switch, i  
    tagging, 43  
FCC compliance, 64  
fireworks, 23  
firmware, upgrading, 61  
flash, i  
    settings, 9  
flower, 23  
focus  
    framing marks, 7  
    zone, 29  
format, 33

## G

grip, i  
guidelines, battery, 60

## H

help  
    web links, 51  
histogram, 36

## I

icons, mode dial, 22  
image storage, 31  
info button, ii

information  
about pictures, videos, 34

installing  
batteries, 2  
SD/MMC card, 4  
software, 14

internal memory  
storage capacity, 57

## J

joystick, ii

## K

Kodak EasyShare software  
installing, 14  
upgrading, 61  
Kodak Web sites, 51

## L

landscape, 24, 25  
language, 33  
LCD, ii  
reviewing pictures, 11  
reviewing videos, 11

lens, i  
cap, 1  
cleaning lens, 61

liveview, 31

loading  
batteries, 2  
SD/MMC card, 4  
software, 14

## M

Macintosh, installing software on, 14

maintenance, camera, 61

manner, 24

manual, 37

memory  
inserting card, 4  
storage capacities, 57

menu button, ii

microphone, i

mode dial, 22

modes

aperture priority, 37

auto, 22

backlight, 23

beach, 23

children, 23

fireworks, 23

flower, 23

landscape, 24

manner, 24

manual, 37

night landscape, 24

night portrait, 24

party, 23

portrait, 23

program, 37

SCN, 22

self-portrait, 24

shutter priority, 37

snow, 23

text, 24

## N

neck strap post, i

night landscape, 24

night portrait, 24

## O

online prints, ordering, 18

open flash switch, i

optical zoom, 8

orientation sensor, 33

## P

party, 23

PASM mode

    screen options, 37

PictBridge printer, 16

picture quality, 28

pictures

    checking settings, 11

    copying, 35

    cropping, 34

    deleting, 13

    emailing tagged, 42

    printing, 18

    printing tagged, 41

    protecting, 13

    reviewing, 11

    storage capacity, 57

    tagging, 39

    taking, modes, 22

    transfer via USB cable, 14

portrait, 23

power

    camera, 3

    switch, i

printer dock, 16, 61

printing

    from a card, 18

    from computer, 18

    optimizing printer, 51

    order online, 18

    PictBridge, 16

    tagged pictures, 18

    with EasyShare printer dock, 16

program, 37

protecting pictures, videos, 13

## R

recycling, disposal, 61

red eye, flash, 9

regulatory information, 64

removing favorites, 44

repair, 51

review, ii

review button, 11

reviewing pictures

    deleting, 13

    LCD, 11

    protecting, 13

    slide show, 26

reviewing videos

    deleting, 13

    LCD, 11

    protecting, 13

    slide show, 26

running slide show, 26

## S

safety, batteries, 59

SCN, 22

SD/MMC card

- inserting, 4
  - printing from, 18
  - slot, ii
  - storage capacities, 57
- self-portrait, 24
- self-timer
  - with pictures, 21
- self-timer/burst button, i
- service and support telephone numbers, 52
- setting
  - AF control, 30
  - album, 30
  - camera sounds, 32
  - color mode, 30
  - date & time, 32
  - date and time, 3
  - date stamp, 33
  - exposure metering, 29
  - flash, 9
  - focus zone, 29
  - image storage, 31
  - language, 33
  - liveview, 31
  - orientation sensor, 33
  - picture quality, 28
  - picture taking mode, 22
  - self-timer, 21
  - sharpness, 30
  - video date display, 32, 33
  - video length, 31
  - video out, 33
  - white balance, 29
- setup mode, using, 31

- share button, ii
- sharpness, 30
- shutter
  - priority, 37
  - problems, 47
  - self-timer delay, 21
  - speed, 37
- slide show
  - continuous loop, 27
  - problems, 48
  - running, 26
- snow, 23
- software
  - installing, 14
  - upgrading, 61
- speaker, i
- specifications, camera, 53
- storage capacity, 57
- support, technical, 52

## T

- tagging
  - favorites, 43
  - for albums, 39
  - for email, 42
  - for print, 41
- telephone support, 52
- television, slide show, 28
- text, 24
- time, setting, 3
- timer, shutter delay, 21
- tips
  - battery guidelines, 60
  - care & maintenance, 61

transfer, via USB cable, 14  
tripod socket, ii  
turning camera on and off, 3

## U

upgrading software, firmware, 61  
URLs, Kodak Web sites, 51  
USB (universal serial bus)  
    transferring pictures, 14  
USB, A/V out, ii

## V

VCCI compliance, 65  
video  
    checking settings, 11  
    copying, 35  
    date display, 32, 33  
    deleting, 13  
    emailing tagged, 42  
    length, 31  
    out, 33  
    protecting, 13  
    reviewing, 11  
    size, 29  
    storage capacities, 57  
    transfer to computer, 14  
    viewing, 11  
viewfinder, ii  
viewing picture  
    after taking, 11  
viewing picture, video information, 34

## W

warranty, 62  
white balance, 29

Windows computers  
    installing software, 14

## Z

zoom  
    button, ii  
    digital, 8  
    optical, 8