

Panasonic

Digital Camera
Operating Instructions

Model No. **KXL-600A**

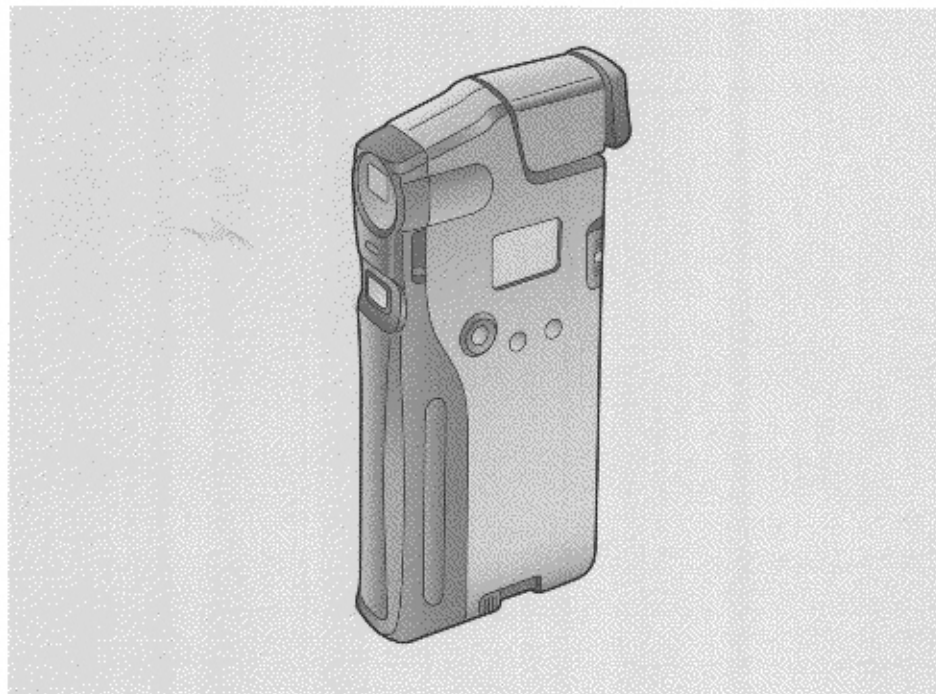

CoolShot

Please read these instructions completely before using. Store this manual with care.

Thank you for purchasing the Panasonic CoolShot Digital Camera KXL-600A.

We expect you will get years of enjoyment from using your camera.

The serial number of this unit may be found on the label located at the bottom of the battery compartment. Write this number below and keep this book along with your proof of purchase receipt to serve as a permanent record of your purchase or for future reference.

For warranty service you may be required to show your proof of purchase receipt. Please fill out and mail the included warranty registration card included with your new camera.

MODEL NO. KXL-600A NAME OF DEALER _____
SERIAL NO. _____ DATE OF PURCHASE _____

- Microsoft, Windows and Win32s are registered trademarks of Microsoft Corporation in the United States and/or other countries.
- PowerBook is a registered trademark of Apple Computer, Inc.
- Macintosh is a trademark of Apple Computer, Inc.

All other brands and product names are trademarks or registered trademarks of their respective companies.

- A software program owned by the Independent JPEG Group is used for compression/decompression of JPEG image data.
The Independent JPEG Group's JPEG software Copyright © 1991, 1996, Thomas G.Lane
This software is based in part on the work of the Independent JPEG Group.

Specifications are subject to change without notice.

All Rights Reserved, © COPYRIGHT 1997 KYUSHU MATSUSHITA ELECTRIC CO., LTD.

- **Testing before Capturing an important image:**

Before capturing an important image(s), it is recommended that you capture a test image and view it to make sure that it was captured as expected.

- **No liability for image data:**

We are not liable for the uncaptured or erased image data caused by failure of the camera, or any repairs made by PANASONIC.

- **About Copyright:**

Copying or modifying any copyrighted material is prohibited without permission from its owner except it is used within the limited right for personal or family.

FOR USERS IN UNITED STATES ONLY

This equipment has been tested and found to comply with the limits for a Class B digital device, pursuant to Part 15 of FCC Rules. These limits are designed to provide reasonable protection against harmful interference in a residential installation.

This equipment generates, uses and can radiate radio frequency energy and, if not installed and used in accordance with the instructions, may cause harmful interference to radio communications.

However, there is no guarantee that interference will not occur in a particular installation. If this equipment does cause harmful interference to radio or television reception, which can be determined by turning the equipment off and on, the user is encouraged to try to correct the interference by one or more of the following measures:

- Reorient or relocate the receiving antenna.
- Increase the separation between the equipment and receiver.
- Connect the equipment into an outlet on a circuit different from that to which the receiver is connected.
- Consult the dealer or an experienced radio/TV technician for help.

The user may find the booklet "Something About Interference" available from FCC local and regional offices helpful.

FCC Warning: To assure continued FCC emission limit compliance, the user must use only the recommended shielded interface cable when connecting to a host computer. Also, any unauthorized changes or modifications to this equipment may void the users authority to operate this device.

■ Features:



Various information can be collected using this handy, compact and light camera.

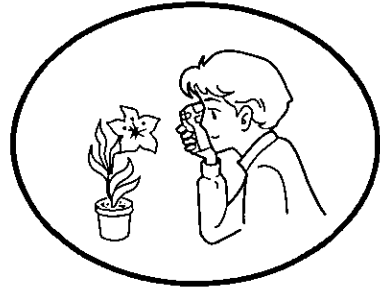

Macro adjustable lens for sharp close-up shots.
(☞ P. 19 "Adjusting Focus/Positioning the Image")

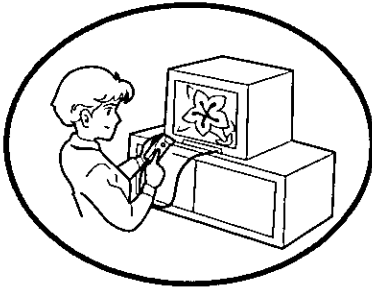

Pictures can be played directly on most TV's (with VIDEO IN jack) using the included TV video cable.
(☞ P. 25 "Playing Back an Image on a TV").

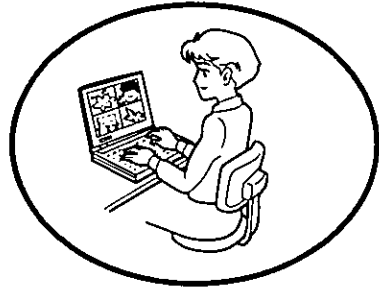

- Fast image transfer using the PCMCIA adapter.
(☞ P. 34)
- Easy image Album organizer software included. (☞ P. 29-67 "Software Section")

Package Contents

Make sure that none of the following items are missing or damaged.
Report damaged or missing items to the store from which the unit was purchased.



2 MB Compact
Memory Card *¹
(KXL-D51) (P. 13)

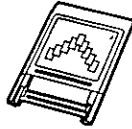

PCMCIA Adapter
(KXL-D55) (P. 34)

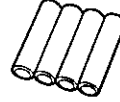

"AAA" Size Alkaline
Batteries (4) (P. 14)



PC Serial Interface
Cable (P. 43)



TV Video Cable
(P. 24)



Wrist Strap
(P. 12)

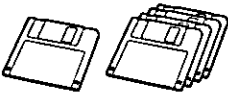

- Application SETUP DISK
- Microsoft® Win32s®^{*2}
Setup Disks ^{*3} (1-4)
(P. 31)

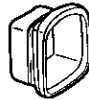

Eye Cap
(P. 12)



Padded Carrying
Case

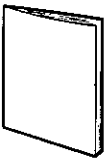

Operating Instructions



Quick Start Guide



Warranty Card

- *¹ Compact memory card is referred to as a memory card in this manual.
- *² Microsoft® Win32s® application programming interface (hereafter Win32s)
- *³ Before opening the software package please read the End-User License Agreement (P. 75).

Table of Contents

Package Contents	5
Precautions	8

Camera Section

Before use

Part Names and Functions	10
LCD Display	11

Preparation

Attaching the Wrist Strap	12
Attaching the Eye Cap	12
Inserting the Memory Card	13
Installing the Batteries	14

Photography (Basic)

Basic Photography	15
Setting Image Quality	18
Adjusting Focus / Positioning the Image	19
Ready Indicator and ND Filter Lever	19

Photography (Advanced)

Using the Self-Timer	20
Capturing a Brighter/Darker Image (Exposure Adjustment)	21
Setting the Beep Sound	22
Avoiding to Capture a Blurred Image	23
Outdoor Photography	23
Indoor Photography	23

Playback / Erasing operation

Connecting the Camera to a TV	24
Playing Back an Image on a TV	25
Erasing a Single Image	26
Erasing All Images at Once	28

Software Section

Software

☞ P. 29 “Table of Contents” for Software Section.

Before use

Preparation

General Information

Care and
Maintenance

Error Display	68
Error Code on the Camera's LCD Display	68
Error Message on the Computer Screen	69
Troubleshooting	71
Camera Issues	71
Software Issues	72
Reformatting the Memory Card	73
Maintenance	74

Appendix

End-User License Agreement	75
Specifications	77
Options	79
Index	81

Photography
(Basic)

Photography
(Advanced)

Playback/
Erasing

Software
(Page 29)

Care and
Maintenance

Appendix

Precautions

General

- Do not use the camera while riding a vehicle.



- Keep your eyes away from the optical viewfinder when extending it by pressing the Push button, or it may damage your eye.

- Do not drop the camera.

- Turn off the camera when replacing batteries/connecting or disconnecting the AC adapter (option).

- Do not disassemble the camera. Do not repair yourself.

- Do not touch the lens cover, keep it clean for quality pictures.

- Do not insert any foreign object such as a clip or pin into the jack of the PCMCIA adapter or the Digital IN/OUT jack, etc.

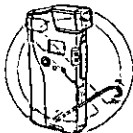

- Do not point the camera at strong light such as the sun, while looking in the viewfinder.

- When using the camera on an airplane, follow the airplane company's instructions.

- Do not subject to intense vibration.

- When the camera has been moved from a cold place to warm place, it may be damp or moist. Leave the camera for one hour before using.

- Keep magnetic objects away from the camera.

- If noise is heard from radio or TV, move the camera 2 m (about 6 ft.) away from the radio or TV.

- Do not get the camera wet.



Storing/Operating environment

To extend the life of the camera, observe the followings.

- Do not store or use the camera in a dusty, humid, oily environment, or under damp or moist conditions.
- Do not leave the camera in direct sunlight, near a heat source or especially in a hot automobile.
- Do not leave the camera with the lens facing a strong light source, such as the sun.
- Store the camera in a cool, less humid place (40% to 60% is recommended) with stable temperature [15°C {59°F} to 25°C {77°F} is recommended].

Alkaline Batteries

To avoid the leakage or corrosion, observe the followings. If leakage or corrosion occurs, replace the batteries immediately with fresh ones.

- Install batteries as indicated in the operating instructions.
- Do not charge, short-circuit, disassemble, heat, or dispose of batteries in fire.
- Remove the batteries as soon as they are used up.
- Make sure the polarity (+, -) matches the diagram inside the camera.
- Use only "AAA" size alkaline batteries. (Do not use manganese or rechargeable batteries.)
- Do not install used batteries with new batteries. Do not mix any other kind of batteries with alkaline batteries.
- Remove all batteries when the camera is not in use for extended periods.

Memory Card

- Do not remove right after an image is captured (while storing the captured image).
- Do not store in a place which develops static electricity or electromagnetic waves.

PCMCIA Adapter

- Do not insert any foreign object such as a clip or pin into the jack of the PCMCIA adapter.

Part Names and Functions

Before Use

Part Names and Functions

LCD display (☞ P. 11)

ND (Neutral density) filter lever [ND FILTER] (☞ P. 19)
Reduces the quantity of light.

MODE button []

SELECT button []

SELECT button []

Video out jack cover
Protects the video out jack when it is not used.

Video out jack [VIDEO OUT] (☞ P. 24)
Insert the included TV video cable here.

Card eject lever [CARD EJECT] (☞ P. 13)
Ejects the memory card.

Memory card slot (☞ P. 13)
Insert the memory card here.

POWER switch [POWER] (☞ P. 15)
Turns the power on/off.

Viewfinder (☞ P. 15)

Push button [] (☞ P. 15)
Raises the viewfinder.

Ready indicator (☞ P. 19)

Jack cover
Protects the Digital IN/OUT jack and the DC IN jack when they are not used.

Digital IN/OUT jack [DIGITAL]
Connect on the included PC serial interface cable (☞ P. 43).

DC IN jack [DC IN 6V ]
Connects the AC adapter (option).

Battery cover (☞ P. 14)

LCD viewfinder/Tripod guides
Attach the 1.8" Color LCD Viewfinder (option), or Tripod Adapter (option).

Focus lever [] (☞ P. 19)
Adjusts a focus.

Scratch resistant lens cover *

Self-Timer indicator (☞ P. 20)





Shutter button []

* Scratch resistant lens cover is referred to as a lens cover in this manual.

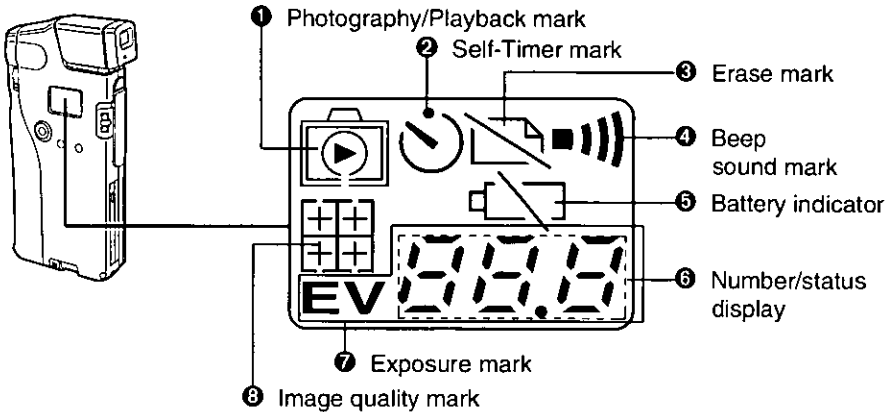
LCD Display

The LCD display allows you to view the status of the camera's functions. It changes when you press the mode button.



No.	Description	Pages
❶	•  appears when the camera is in the Photography mode.	15
	•  appears when the camera is in the Playback mode.	25
❷	This mark appears when the camera is in the Self-Timer mode.	20
❸	This mark appears when the camera is in the Erase mode.	26, 28
❹	This mark appears when the beep sound is set to ON. If set to OFF, no mark appears.	22
❺	This mark appears when the battery is low.	14
❻	• Number of available images appears when the camera is in the Photography mode.	15
	• "ON" or "OFF" appears when setting the beep sound.	22
	• The current image number appears when the camera is in the Playback/Erase mode.	25-28
	• Options such as "ALL" or "DEF" appear when the camera is in the Erase mode.	26-28
• An error code appears when an error occurs.	68	
❼	The "EV" and the exposure level (-2.0 to 2.0) appear when the camera is in the Exposure adjustment mode.	21
❽	•  appears when the Fine mode is selected, and  appears when the Normal mode is selected.	18

Attaching the Wrist Strap

Attach the included wrist strap and pass your hand through it when you are using or carrying the camera to prevent from dropping it.

Preparation

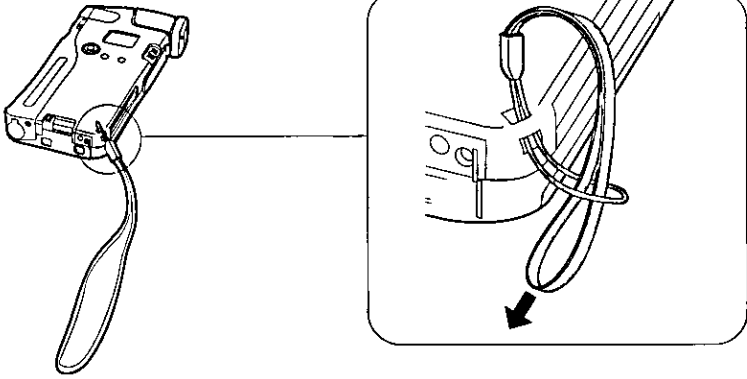

Attaching the Eye Cap

Attaching the included eye cap provides the following benefits:

- Reduces peripheral vision, which makes picture taking easier.
- Reduces ambient light in viewfinder for more comfort.
- Easier for casual user to frame a picture.

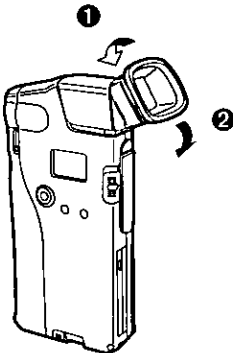
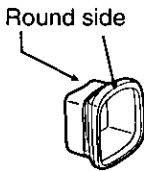

Attach the included eye cap on the finder with the round side upward.

Inserting the Memory Card

The memory card stores the captured images.
Make sure to insert the memory card before capturing an image.

Notes:

- Do not insert/remove the memory card when the camera is on, or it may corrupt the image data.
- Use of the included or optional compact memory card (P. 79) is recommended. However, other ATA compact memory cards are widely available. They must be SanDisk compatible, and be formatted for use in the Panasonic KXL-600A (P. 73 "Reformatting the Memory Card").

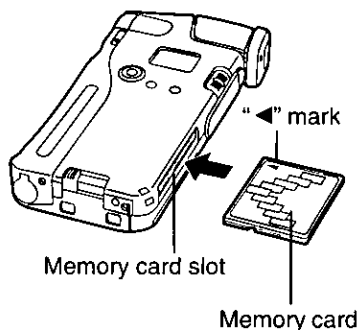

Make sure the camera is off.

Insert the memory card fully into the memory card slot with the "◀" mark side facing up.

■ Removing the Memory Card:

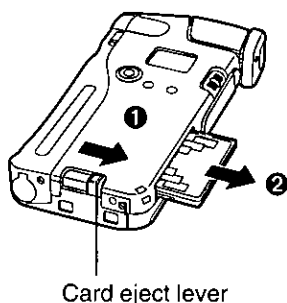



Make sure the camera is off.

Slide the card eject lever in the direction indicated by the arrow (①) and remove the memory card (②).

Installing the Batteries

Use only "AAA" size alkaline batteries. Do not use manganese or rechargeable batteries, etc.

Notes:

- When the battery is low the blinking battery indicator "  " appears on the LCD display, and when the battery is used up, the camera beeps three times, "  " is displayed on the LCD, then the camera is automatically turned off.
- If the batteries are used at a temperature below about 10°C {50°F}, battery power may be deteriorated momentarily. Please warm the camera putting it inside your clothes etc. so that it can be used.

1

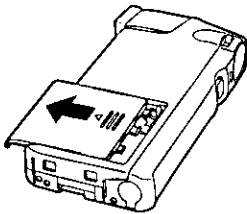

Remove the battery cover by sliding it in the direction indicated by the arrow.

2

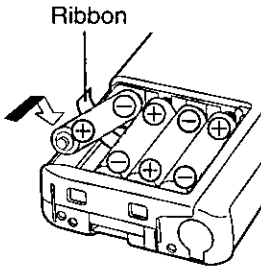

Install the included four (4) "AAA" size alkaline batteries placing the ribbon underneath them.

The ribbon allows the batteries to be removed easily when replacement becomes necessary.

3

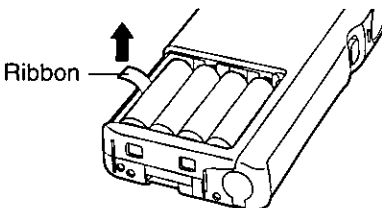

Replace the battery cover.

■ Removing the Batteries:



Pull the ribbon upward to remove the batteries.

Basic Photography

Make sure that the memory card is inserted ( P. 13) and the batteries are installed ( P. 14).

1

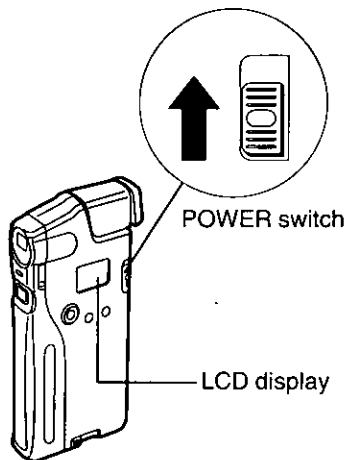

Turn on the camera by holding up the power switch in the direction indicated by the arrow until the display is illuminated.

The camera will enter the Photography mode and beep twice (if the beep sound is set to ON).

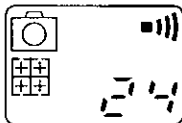

- To turn off the beep sound, refer to page 22.
- To turn off the camera, hold up the power switch again. "  " appears on the LCD display before power goes off.

■ Automatic Power OFF:

If no operation is performed within a time shown in the following table, the power goes off automatically to save power. To turn on the camera, hold up the power switch again.

Power Source	Time		
	in Photography mode	in Playback or Erase mode	in Transfer mode
When using alkaline batteries	1 min.	1 min.	1 hour
When using AC adapter (option)	5 min.	1 hour	1 hour

2

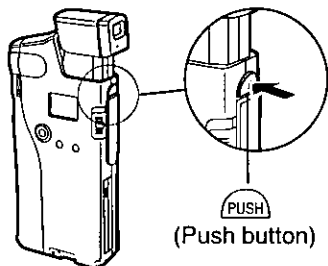

Press  (Push button).

The viewfinder will pop up.

3

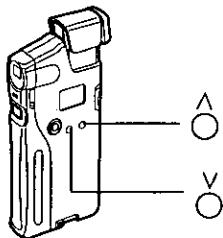

Press or to select image quality (Fine or Normal).

: Fine mode (High resolution)

: Normal mode (Normal resolution)

The default setting is Fine.

For detailed information about the image quality, refer to page 18.

4

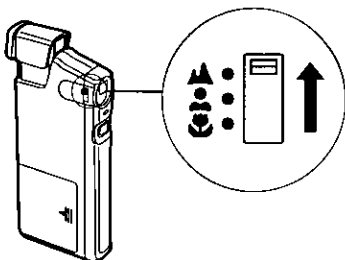

Select an object and adjust a focus using the focus lever.

Focus lever position	Focus adjustment range
	more than 1 m {39.37"}
	50 cm - 1 m {19.69" - 39.37"}
	13 - 15 cm {5.12" - 5.91"}

For detailed information, refer to page 19.

5

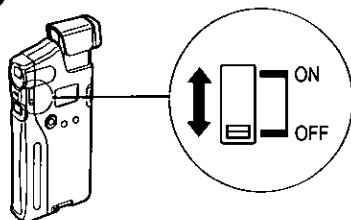

Set the ND filter lever to ON/OFF.

- **ON:** When taking images outdoors
- **OFF:** When taking images indoors

For detailed information about the filter, refer to page 19.

6

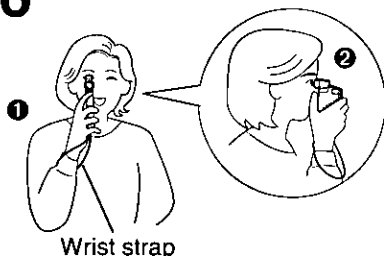

Wrist strap

Pass your hand through the wrist strap and hold the camera firmly.

Do not cover the lens cover with your finger.

Notes for preventing the camera from moving:

- Keep your arm against your body (❶).
- Raise your thumb and place it between camera and your face (❷).

7

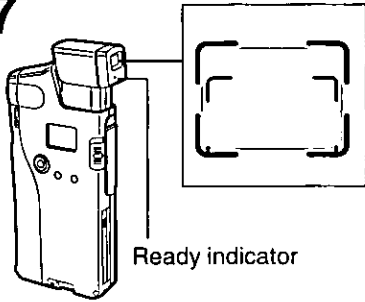



Position the image within the graticule marks of the viewfinder.

Make sure that the green ready indicator is lit. If it is not, refer to page 19.

For detailed information about positioning an image, refer to page 19.

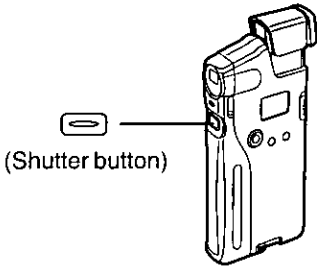
8



Press  (Shutter button) until the camera beeps once.

If an image is captured and stored to the memory card properly, the camera will beep twice and the number of available images will decrease by one.

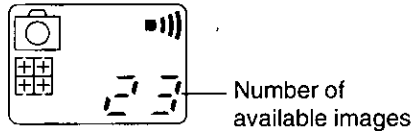

■ **Continuous Image Capture:**
If you hold down  (Shutter button), images can be captured repeatedly (Images will be captured with intervals of approx. 1 second in the Fine mode, and approx. 0.5 second in the Normal mode).

Note:

- If an image cannot be captured properly, the camera beeps three times.

9

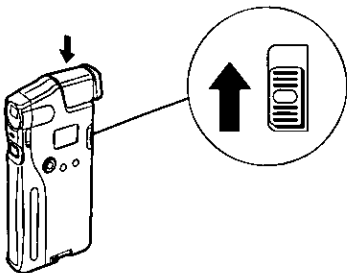

Store the viewfinder by pressing it down until it clicks, and turn off the camera.

Note:



- To extend the battery life, always turn off the camera when it is not in use.

Setting Image Quality

Fine mode or Normal mode can be selected.

The Fine mode provides higher resolution than the Normal mode.

Since higher resolution images occupy more memory, less images can be captured in the Fine mode.

Setting	Resolution	The number of available images	
		Using 2 MB Memory Card	Using 4 MB Memory Card (option)
Fine * 	640 × 480 pixels	24	48
Normal 	320 × 240 pixels	96	192



* Default setting

- The setting of image quality is saved on the memory card and remains the same even if you turn off the camera or remove the memory card.
- The image capture quality can be changed at any time.
- Fine and Normal resolution images can be combined on the memory card.
- The number of available images in the current setting will appear on the LCD display.

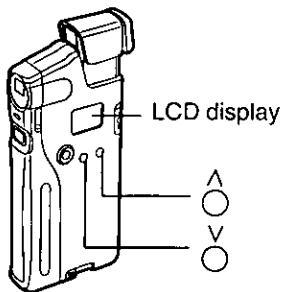
Perform the following steps for selecting image quality.





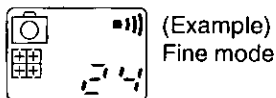

1 Turn on the camera.



Either one of the marks ( or ) appears on the LCD display.







2 Press / to change the mode.

-  :  Fine mode (High resolution)
-  :  Normal mode (Normal resolution)

Adjusting Focus / Positioning the Image

Focus should be adjusted with respect to the distance between the camera and the subject. To adjust a focus, set the focus lever to the appropriate position ( table below). When capturing an image in the macro mode, position the image within the smaller viewfinder graticule marks ( illustration below).

Focus lever position	Focus adjustment range	Position of an image
	More than 1 m {39.37"} for landscape shot	Position an image within the grey shade (the bigger viewfinder graticule marks). 
	50 cm – 1 m {19.69"-39.37"} for bust shot	
	13 – 15 cm {5.12"-5.91"} for close shot (Macro mode)	Position an image within the grey shade (the smaller viewfinder graticule marks). 

Notes:

- Make sure that the focus lever is set correctly before capturing an image, otherwise the image will be out of focus.
- When the distance is less than 13 cm or between 15 cm and 50 cm, a focus cannot be adjusted. Capture an image within the focus adjustment range.

Ready Indicator and ND Filter Lever

The green ready indicator lights when the quantity of light is correct to capture an image. The ND filter lever allows you to reduce the quantity of light by setting it to ON.

- When the camera is used at a dark place such as indoors, set the ND filter lever to OFF.
- When the camera is used at a bright place such as outdoors, set the ND filter lever to ON.

The ready indicator must be lit before capturing an image. If the ready indicator is blinking, the quantity of light is either insufficient or excessive to capture an image.

Ready indicator	Quantity of light	ND Filter lever
Lit	Sufficient	As it is
Blinking	Insufficient*1	Set to OFF
	Excessive*2	Set to ON (indicator will be lit)

*1 **Insufficient:** Photography is possible but it is recommended to use an additional light source such as video light (not supplied).

*2 **Excessive:** Photography is not possible.

Notes:

- The ready indicator stays on for 3 seconds after capturing an image. Photography is still possible, however, the captured image may not be desirable if the quantity of light changes significantly within this time.
- While looking through the viewfinder if you move the camera the ready indicator may go off due to an unstable quantity of light. In this case, wait for a few seconds until the ready indicator is lit or starts blinking, then capture an image.

Using the Self-Timer

You can capture an image of yourself using the Self-Timer function.

When Set in Self-Timer mode, an image will be captured approx. 10 seconds after

 (Shutter button) is pressed.

To avoid possible damage to the camera, we recommend using a tripod (not included). Attach the camera to the tripod with the tripod adapter (option).

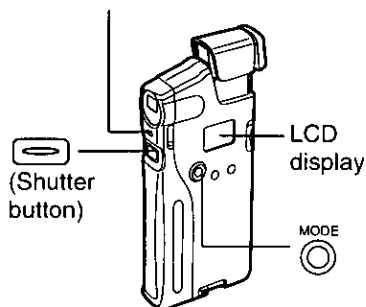

Perform the following steps to use the Self-Timer.

Self-Timer indicator





Photography
(Advanced)

Using the Self-Timer

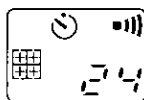
- 1 Press  .
“” appears on the LCD display.



- 2 Press  (Shutter button).

The Self-Timer indicator and the Self-Timer mark “” start blinking and after approx. 10 seconds the camera will capture an image.

- To cancel the operation, turn off the camera while the Self-Timer mark “” is blinking.

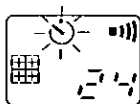

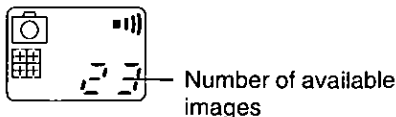

While the Self-Timer indicator is blinking the camera will beep (if beep sound is set to ON).

After capturing an image, the number of available images decreases by one.

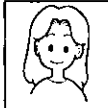

Capturing a Brighter / Darker Image (Exposure Adjustment)

The camera automatically adjusts the exposure. However, you may prefer to adjust the exposure manually.

Situation		Adjustment	Expected result
To capture a brighter image in a relatively dark place.		Increase the exposure value.	
To capture a darker image in a bright place.		Decrease the exposure value.	

Perform the following steps to adjust the exposure value.

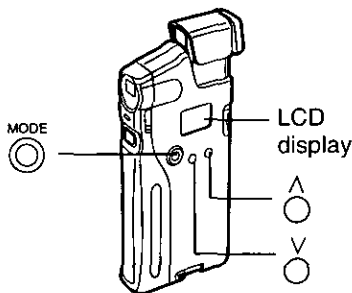

Notes:

- If you turn off the camera, the adjusted exposure value will return to 0.0. The exposure setting is not saved on the memory card.



• If there is big difference of brightness between an object and its background in a image, the captured image of object may be too bright or too dark.

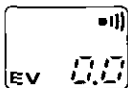

When capturing the image of a dark object in a bright background, increase the exposure value.

When capturing the image of a bright object in a dark background, decrease the exposure value.

- 1 Press  repeatedly until the exposure mark "EV" and "0.0" appear on the LCD display.



- 2 Press  or  to select an exposure value (-2.0 to +2.0).

-  : increases the exposure value by 0.5.
-  : decreases the exposure value by 0.5.

- 3 Press  to save the selection. The camera will enter the Photography mode.

- 4 Capture an image ( P. 15-17).

Setting the Beep Sound

If the beep sound is set to ON, the beep sound will be heard when an error occurs or an operation is completed. If the beep sound is set to OFF, no beep sound will be heard.

Setting	Display
ON *	■)
OFF	None



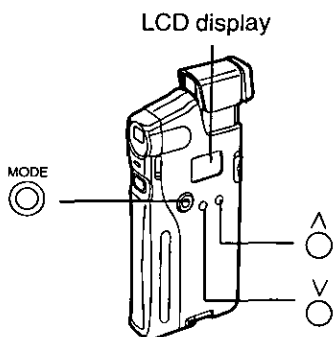

* Factory default

Perform the following steps for setting the beep sound.

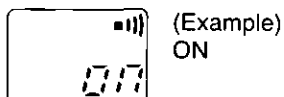

- 1 Press  repeatedly until the beep sound mark "■||)" and "ON" or "OFF" appear on the LCD display.





- 2 Press  /  to select ON or OFF.
 : ON
 : OFF

- 3 Press  to save the selection.
The camera will enter the Photography mode.

The setting of the beep sound is saved on the memory card and is retained even if you turn off the camera or remove the memory card.

Avoiding to Capture a Blurred Image

While pressing  (Shutter button) if the camera is moved, a blurred image may be captured. To avoid this, observe the following.

- When you press  (Shutter button), press it gently.
- When capturing an image at a dark place, shutter speed will be slower. To capture a desirable image, hold the camera steady until you press  (Shutter button). It is recommended to attach a tripod (not included) to the camera using the tripod adapter (option).

Outdoor Photography (In a Bright Place)

When capturing an image under strong light source (reflection), or at a partially bright place, a shining line (such as green, white, etc.) may appear on the captured image. Set the ND filter lever to ON to soften the shining line.

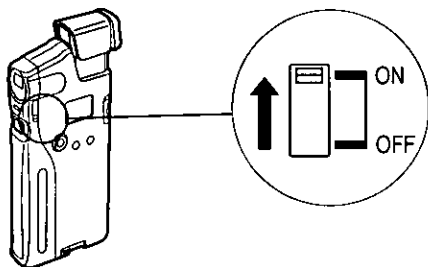

Indoor Photography

When capturing an image indoors, set the ND filter lever to OFF. If an image is captured with the filter lever set to ON indoors, the captured image will be very dark or black.

■ For areas with 50 Hz electric power frequency:

When capturing an image indoors with a fluorescent lamp turned on, the brightness or color of image may slightly change because of flickering of a lamp. Please use sufficient source of light such as a commercial video light.

Note:

- If an object which emits infrared rays is captured, it will tend to appear green. This occurs because the camera's CCD imaging device is sensitive to infrared rays and it is not an abnormal condition.

Connecting the Camera to a TV

You can play back images on a TV (with a VIDEO IN jack) connected to the camera using the included TV video cable.

Follow the steps below to connect the camera to a TV.

Notes:

- This camera cannot be connected to a TV without a VIDEO IN jack.
- When playing back an image on TV, it is recommended that you use the AC adapter (option) instead of batteries to extend battery life.

1

Video out jack cover

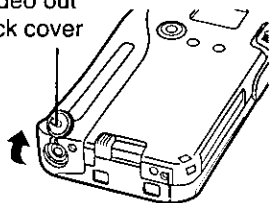

Open the video out jack cover (at the bottom of camera) by using a pointed object like a ball point pen (do not use a pencil).

2

Connect the included TV video cable to the camera and to a TV.

Note:

- The location of a VIDEO IN jack is different depending on the TV. For easy connection, refer to your TV's manual.

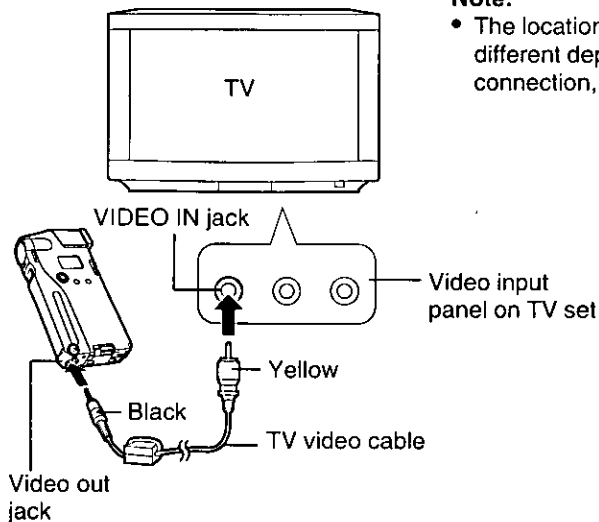

Playing Back an Image on a TV

Make sure that you have properly connected the camera to your TV (P. 24).

The 1.8" Color LCD Viewfinder (option) can also be used to play back the captured image. Refer to the option's manual.

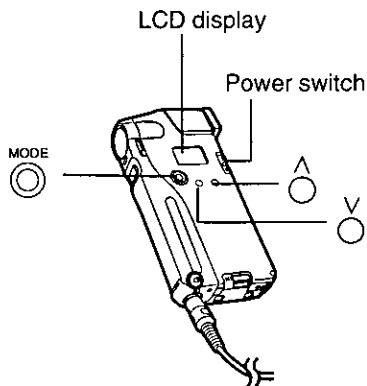

Slide Show Function

■ To play back images on TV automatically (with an interval of about 5 seconds):

While holding down  turn on the camera.

- When using batteries, all images are played back once and the camera goes off.
- When using the AC adapter (option), images are played back repeatedly. In this case, Automatic Power OFF function does not work.
- To exit the operation, turn off the camera.

1 Turn on the camera and TV (switch the TV to the video mode).

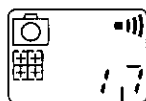

(Example)
7 images are captured in the Fine mode.

Number of available images

2 Press repeatedly until "▶" appears on the camera's LCD display.

The most recently captured image appears on the TV. The number displayed in the lower right hand corner on the TV screen and on the camera's LCD display is the number assigned to the currently displayed image.

- To turn off the image number on TV screen, press  (Shutter button).

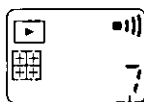

(Image number)





The most recently captured image

If there is no image data, "no" will appear on the camera's LCD display.

3 Press or to change the image on TV.

 : Plays back the previous image.

 : Plays back the next image.

- Pressing and holding down  /  will reverse/advance images quickly.

Erasing a Single Image

Please connect the camera to a TV (P. 24) so you are able to view the image, and be sure it is the one you wish to erase.

The 1.8" Color LCD Viewfinder (option) can also be used to view the image. Refer to the option's manual.

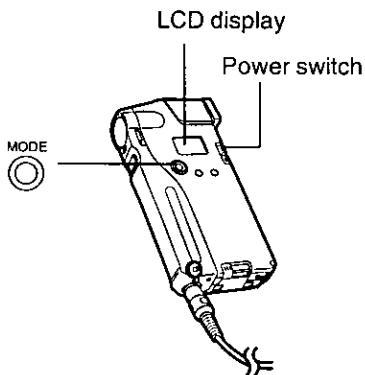

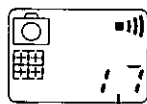

- 1 Turn on the camera and TV (switch the TV to the video mode).



(Example)
7 images are captured in the Fine mode.

Number of available images

- 2 Press  repeatedly until "  " appears on the camera's LCD display.

The most recently captured image appears on the TV. The number displayed in the lower right hand corner on the TV screen and on the camera's LCD display is the number assigned to the currently displayed image.





(Image number)



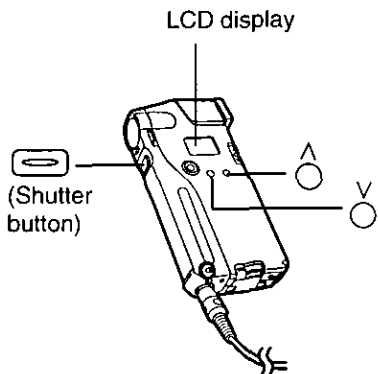

The most recently captured image



If there is no image data, "70" will appear on the camera's LCD display.



3 Press  /  to select the image you wish to erase.

 : Plays back the previous image.

 : Plays back the next image.

- Pressing and holding down  /  will advance/reverse images quickly.

4 Press  (Shutter button).

The image number on the camera's LCD display will start blinking for confirmation.

5 While the image number is blinking (within 5 seconds), press  (Shutter button) again.

The message "DEL" appears on the camera's LCD display and the selected image will be deleted from the memory card.

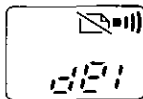

Note:

- If  (Shutter button) is not pressed within 5 seconds while an image number is blinking, you will return to step 3 again. When you wish to erase the image, perform steps 4 and 5 again.



6 To delete more images repeat steps 3 to 5.

Erasing All Images at Once

Caution:

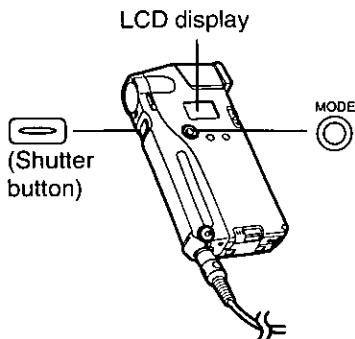
- This procedure will erase all images currently stored on the memory card in your camera.



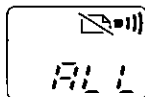

- 1 Press  repeatedly until “” and “ALL” appear on the LCD display.



If there is no image data, “” will appear on the LCD display.

- 2 Press  (Shutter button). “ALL” starts blinking for confirmation.

- 3 While “ALL” is blinking (within 5 seconds) press  (Shutter button) again. “” appears on the LCD display, and “” starts blinking.

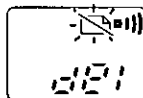

After all images are deleted, the camera will return to the Photography mode.

Notes:



- If  (Shutter button) is not pressed within 5 seconds while the message “ALL” is blinking, you will return to step 1 again. When you wish to erase all images, perform steps 2 and 3 again.
- If the blinking battery indicator “” appears, you cannot erase all images. Replace the batteries with new ones or use the AC adapter (option) and perform steps 1 to 3.

Table of Contents

Software Section

<p>Before use</p>	<p>System Requirements 30</p>	<p>Before use</p>
<p>For a Computer with PC Card Slot (PCMCIA)</p>	<p>Setup 31 Software Installation 31 Inserting the PCMCIA (PC Card) Adapter into Your Computer 34 Before Operation 36 Opening the Main Window 36 Operation 37 Opening the Captured Images 37 Saving the Captured Images to the Computer 41</p>	<p>For a Computer with PC Card Slot (PCMCIA)</p>
<p>For a Computer with Serial I/F Connector</p>	<p>Setup 43 Software Installation 43 Connecting the PC Serial Interface Cable to the Camera and the Computer 43 Before Operation 44 Opening the Main Window 44 Preparation for Transferring the Data 44 Operation 45 Opening the Captured Images 46 Saving the Captured Images to the Computer 47</p>	<p>For a Computer with Serial I/F Connector</p>
<p>Advanced Operation (Common)</p>	<p>Opening Images Saved on the Computer 49 Editing an Image 51 Printing Image(s) 56 Pasting an Image into Another Application 58 Saving an Edited Image to the Memory Card 59 When Using the PCMCIA Adapter 59 When Using the PC Serial Interface Cable 61 Displaying Images One After Another (Slide Show) 62 Deleting Image Data 63 Other Functions 64</p>	<p>Advanced Operation (Common)</p>

System Requirements

To run the application software, you need the hardware and software outlined in the following tables.

Before use

■ Hardware Requirements:

Unit	IBM or IBM Compatible Computer
CPU	More than i486 (25 MHz)
Free Hard disk drive space (for images and program data)	30 MB minimum For installing Panasonic image editing software program Windows 95 1.4 MB minimum Windows 3.1 8.4 MB minimum
RAM	More than 8 MB (more than 16 MB is recommended)
Display	More than 256 colors and more than 640 × 480 pixels [True color (16.7 million colors) is recommended]
Floppy Disk drive	3.5 inch (Readable of 1.44 MB format disk)
Interface	PCMCIA Type II slot, or RS-232C serial interface connector

System Requirements

■ Software Requirements:

OS	Windows 95* ¹ , Windows 3.1, 3.11* ²
----	--

*¹ Microsoft® Windows® 95 operating system (hereafter Windows 95)

*² Microsoft® Windows® operating system Version 3.1 or 3.11
(hereafter Windows 3.1, 3.11)

■ For Macintosh user:

If your Macintosh computer has PCMCIA Type II card slot (PowerBook) and the OS is System 7.5.2 or later, the included PCMCIA adapter can be used. To transfer an image data to your Macintosh, use image conversion application software (not included) or the application software included in the Macintosh interface kit (option).

Software Installation

Install the software using the included Setup disk(s).
Before installing the software, make sure that you make a back-up copy and store the original in a safe place. To make a back-up copy, refer to your computer manual.

Before use

1 Turn on the computer.

Make sure Windows 95 or Windows 3.1, 3.11 is running. If you are using Windows 95, skip next step and go to step 3.

2 Install Win32s* (*only for Windows 3.1, 3.11*).

- ❶ Insert the included "Microsoft® Win32s® Setup Disk 1" disk into the floppy disk drive.
- ❷ Click "Run..." from the File menu of the Program Manager.
- ❸ Type `A:\SETUP.EXE` and click .

Note:

- The drive name may differ depending on the drive where the disk is inserted. If the drive is B, type `B:\SETUP.EXE`.

- ❹ Follow the instructions on the computer screen.

3 Insert the included Application SETUP DISK into the floppy disk drive.

Go to 4A for Windows 95, and 4B for Windows 3.1, 3.11.

For a Computer with
PC Card Slot (PCMCIA)

Setup (Software Installation)

* Win32s is the software program for 32 bit application software to work under Windows 3.1, 3.11.

4A (For Windows 95)

- 1 Click **Start**, point to "Settings", then click "Control Panel".
The "Control Panel" window appears.
- 2 Double-click the Add/Remove Programs icon ().
The "Add/Remove Programs Properties" window appears.
- 3 Click **Install...**.
The "Install Program From Floppy Disk or CD-ROM" window appears.
- 4 Click **Next>**.
The "Run Installation Program" window appears.
- 5 Click **Finish**.
The "Starting Installation" window appears.

You can also perform the following steps instead of 1 to 5 above.

- 1 Click **Start** and select "Run...".
- 2 Type `A:\SETUP.EXE` and click **OK**.
(If the drive is B, type `B:\SETUP.EXE` and click **OK**.)

4B (For Windows 3.1, 3.11)

- 1 Click "Run..." from the File menu of the Program Manager.
- 2 At the Command Line, type `A:\SETUP.EXE`

Note:

- Type the drive name where the setup disk is inserted. If the drive is B, type `B:\SETUP.EXE`

- 3 Click **OK**.
The "Starting Installation" window appears.

5 Click **OK**.

The "Destination Directory" window appears.
If you wish to change the directory name, retype it.

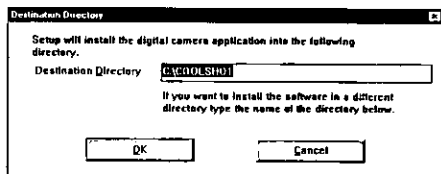

- 6 Click .
The "Confirm" window appears.
- 7 Click .
The "Copying" window appears while software is being copied.
The "Ending Installation" window appears when copying is finished.
- 8 Click .

README file on the included software contains late breaking additional information. Please read this file before proceeding. You can open this file by either one of the following methods.

- For Windows 95:
Click , point to "Programs", "Panasonic Digital Camera" and click "Readme".
- For Windows 3.1, 3.11:
Double-click the "Readme" icon in the Panasonic Digital Camera group.

For a Computer with
PC Card Slot (PCMCIA)

Uninstalling Software

- 1 *(For Windows 95)*
Click , point to "Programs", point to "Panasonic Digital Camera" then click "Uninstaller".

(For Windows 3.1, 3.11)
Open "Panasonic Digital Camera" and double-click "Uninstaller".

The "Starting Uninstallation" window appears.
- 2 Click .
The "Confirm" window appears.
- 3 Click .
The "Ending Uninstallation" window appears.
- 4 Click .

Setup (Uninstalling Software)

Inserting the PCMCIA (PC Card) Adapter into Your Computer

If your computer has PCMCIA Type II card slot, the memory card can be inserted directly into your computer by using the included PCMCIA adapter.

The benefit of using the PCMCIA (PC card) adapter is it provides much faster image data transfer than the serial interface connection.

The PCMCIA adapter can be inserted with the computer turned on. However, for Windows 3.1, 3.11, a Card Service software must be previously installed ( your computer manual).

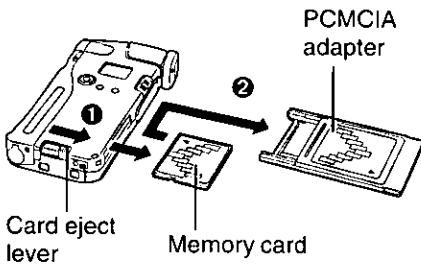

- 1** Make sure the camera is turned off.
- 2** Remove the memory card from the camera by sliding the card eject lever (**1**), and insert it fully into the PCMCIA adapter with the “ ◀ ” mark side facing up (**2**).
- 3** Insert the PCMCIA adapter fully into the PC card slot of your computer *.

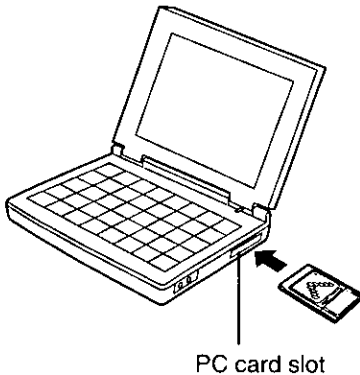

Notes:

- If you are using Windows 3.1, 3.11 ATA card driver must be installed in advance. Refer to your computer manual.
- On some computers you might have to insert the PCMCIA adapter upside down. Refer to your computer manual.

* Third party PC card slots are also available for desktop computers.

Removing the PCMCIA adapter from the computer

Caution:

- While a data is being transferred between the memory card and your computer (displaying, saving images, etc.) do not remove the PCMCIA adapter from your computer, or it may corrupt the image data.

■ Before removing the PCMCIA adapter:

For Windows 95

The PCMCIA adapter can be removed with the computer turned on. However, before removing it, perform the following steps.

- 1 Click PC Card icon () in task bar.

The following message appears.



- 2 Click "Stop SunDisk ATA FlashDisk".

The following message appears.



- 3 Confirm the message "You may safely remove this device" and click .

For Windows 3.1, 3.11

The PCMCIA adapter can be removed with the computer turned on if a Card Service software is installed. However, before removing the PCMCIA adapter make sure that the computer is not booting up.

- 1 Remove the PCMCIA adapter from your computer's card slot.

Before Operation

Opening the Main Window

1 Turn on the computer.

2 (For Windows 95)

Click **Start**, point to "Programs", point to "Panasonic Digital Camera", and then click "CoolShot".

(For Windows 3.1, 3.11)

Open the "Panasonic Digital Camera" group from the Program Manager and double-click "CoolShot".

The "Digital Camera" window appears.

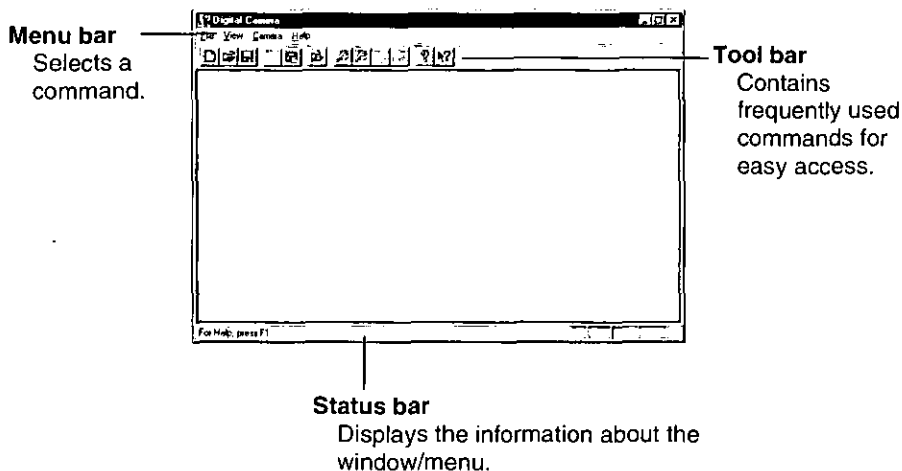

■ View menu:

You can select to display the Tool bar and Status bar or not from the View menu.

■ Exiting the application:

Click **Exit** from File menu.

Operating instructions described hereafter are based on Windows 95. Flow of operation using Windows 3.1, 3.11 is same as that of Windows 95.

Operation

Opening the Captured Images

A captured image can be opened and viewed on your computer screen. Before performing any of the advanced operations (P. 49-67) on an opened image, it is recommended that you save a copy to your computer (P. 41) to avoid corrupting the original image.

You can open an image either from a file list (below "Opening an image from a file list") or from an album (miniature thumbnails) (P. 39 "Opening an image from an album").

Opening an image from a file list

1 Click "Open..." from the File menu.

The "Open" window appears.

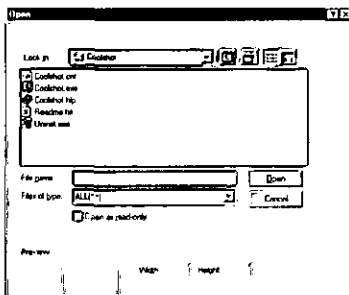

2 In the "Files of type" dialog box, select "JPEG (*.jpg)".

The captured images are stored in the memory card with the JPEG type.

2 In the "Look in" dialog box, click the drive letter assigned for the memory card.

If "D" is assigned for the memory card, click "Kxl-600a [D:]". The "Dc97" folder icon appears.

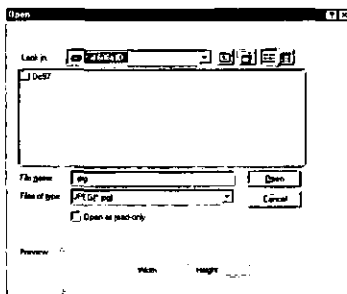

The captured images are stored in the "Dc97" folder inside the memory card.

3 Double-click the "Dc97" folder icon.

A list of file names appears.

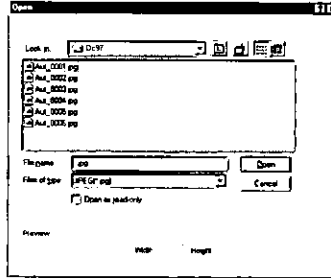

4 Click the file name you wish to open.

The selected image appears in the preview screen.

- The resolution of the selected image is displayed next to the preview screen in pixels.
- If the box of "Open as read-only" is checked, the displayed image cannot be saved under the same file name to prevent it from edited and saved accidentally.
- Aut_0001.jpg, Aut_0002.jpg ... are the file names assigned for the captured image data.

5 Click **Open**.

The image file will be opened.

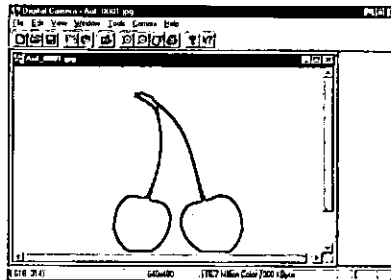

- To save the image, see P. 41 "Saving an opened image".
- To close the image file, click "Close" from the File menu, or click on the file window.

Opening an image from an album

1 Click "Open Album..." from the File menu.

The "Open Album" window appears.

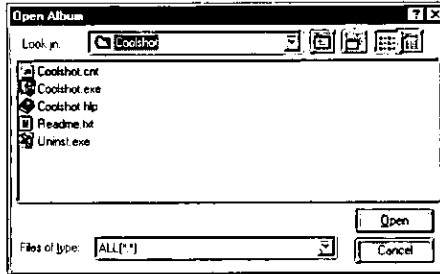

2 ① In the "Files of type" dialog box, select "JPEG (*.jpg)".

② In the "Look in" dialog box, click the drive letter assigned for the Memory Card.

If "D" is assigned for the memory card, click "KxI-600a[D:]".
The "Dc97" folder icon appears.

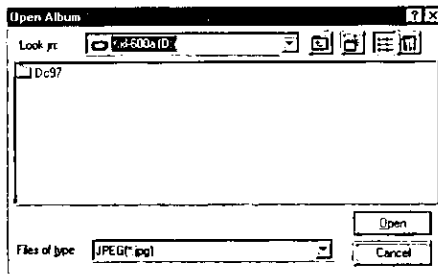

The captured images are stored in the "Dc97" folder inside the memory card.

3 Double-click the “Dc97” folder icon, and click **Open** .

The Album window appears.

The image files in the “Dc97” folder appear as miniature thumbnails in file name (number) order.

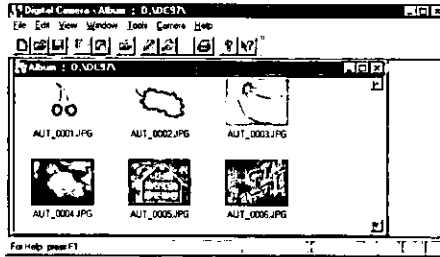

4 Double-click the image file you wish to open.

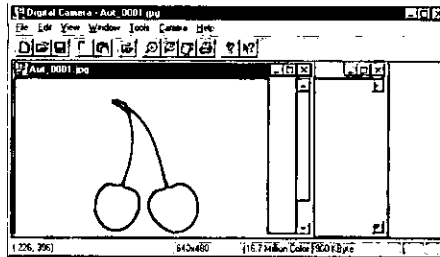

The image file will be opened.





- To save the image, see P. 41 “Saving an opened image”.
- To close the image file, click “Close” from the File menu, or click on the file window.

Saving the Captured Images to the Computer

Save the captured images to your computer when;

- the memory card has become full and you wish to delete the image data on the memory card ( P. 63).
- you wish to perform any of the advanced operations, such as editing, pasting, etc. ( P. 49-67 “Advanced Operation”).

You can save the image opened from a file or an album ( below “Saving an opened image”).

You can also save the image(s) from an album at once without opening the image files ( P. 42 “Saving the image(s) from an album”).

Saving an opened image

- 1 Open an image ( P. 37, 39).
- 2 Click “Save As...” from the File menu.
The “Save As” window appears.

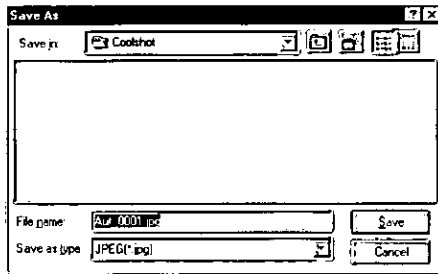

- 3
 - 1 In the “Save in” dialog box, select the drive and folder where you want to save the image.
 - 2 In the “Save as type” dialog box, select a file type (BMP, JPEG or TIFF).
For detailed information about the file type, refer to page 77 “Specifications”.
 - 3 In the “File name” dialog box, type the file name (Refer to your Windows manual).
- 4 Click **Save**.
The image file will be saved.

Saving the image(s) from an album

You can save more than one/all images at once without opening the image files.

- 1 Open an album (P. 39).

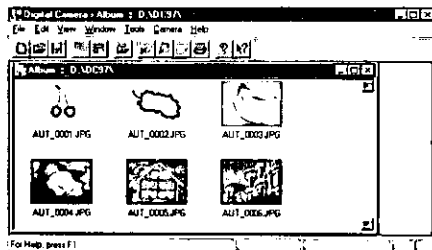

- 2 Select the image(s) you wish to save.

- To select all images, click "Select All" from the Edit menu.
- To select multiple images, click the individual images while holding down **Ctrl**.
- To select one, click the image.

The selected image(s) will be highlighted.

- To cancel the selection(s), move the cursor to any empty space on the Album window and click.

- 3 Click "Save From Album..." from the File menu.

The "Save From Album" window appears.

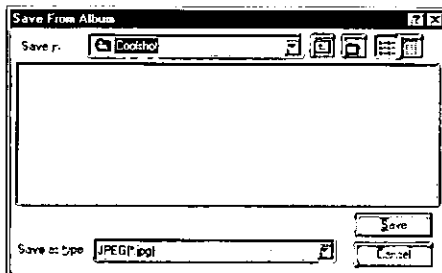

- 4 In the "Save in" dialog box, select the drive and folder where you want to save the images, and click **Save**.

The selected image(s) will be saved to your computer with the same file name and file type as they were saved on the memory card.

Setup

Software Installation

Follow the instructions on page 31-33.

Connecting the PC Serial Interface Cable to the Camera and the Computer

Use only the included PC serial interface cable to connect the camera to your computer.

Make sure that the camera and your computer are turned off and the memory card is inserted into the camera.

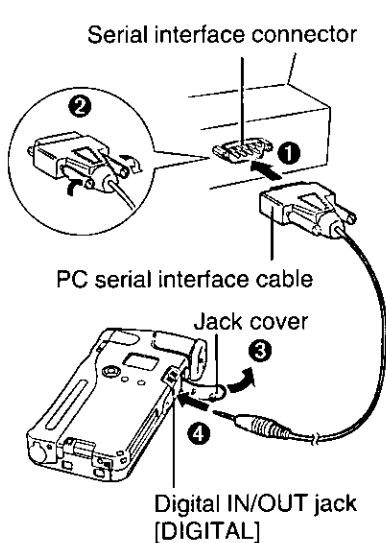

- 1** Connect one end of the PC serial interface cable to the serial interface connector of your computer (❶), and tight the screws (❷).
- 2** Open the jack cover (❸), and connect the other end of the cable to the Digital IN/OUT jack of the camera (❹).

Before Operation

Opening the Main Window

Follow the instructions on page 36.

Preparation for Transferring the Data

To transfer data between the camera and your computer you have to select a communication speed and a port, then turn on the camera.

- 1 Click “**Communications Setup...**” from the **Camera** menu.
The “Communications Setup” window appears.

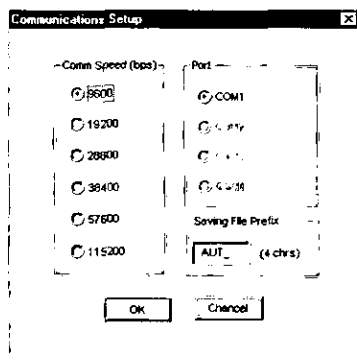

- 2 Select a “**Comm Speed (bps)**”, a **Port** and if you wish to change the saving file name type it using 4 characters, then click **OK**.

■ **Comm Speed (bps):**

Select a speed of data transfer rate. If the data cannot be transferred properly, select the next Comm Speed.

■ **Port:**

Select the port where the PC serial interface cable is connected.

■ **Saving File Prefix:**

Enter the saving file prefix (use 4 characters).

“Aut_” is the default setting. If you don’t change, the same file prefix (“Aut_”) will be assigned.

- 3 Turn on the camera by hold up the power switch.

Note:

- Make sure the camera is in the Photography “” or Playback “” mode.

■ Transfer mode:

While a data is being transferred between the camera and your computer, the blinking mark "⏏" appears on the camera's LCD display and the "Processing Status" window appears on the computer screen.

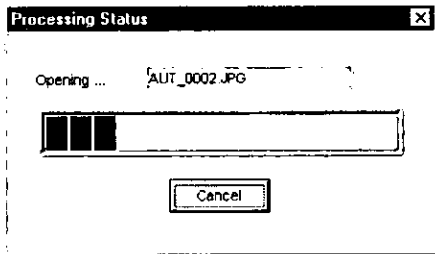

(On your computer screen)

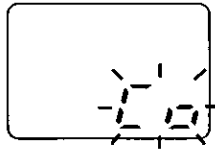

(On the camera's LCD display)

Notes:

To prevent communication errors, system lockup or data corruption observe the following precautions.

- Do not turn off either the camera or your computer while the "⏏" mark is blinking on the camera's LCD display or when a camera album is opened.
- It is recommended to use the AC adapter (option) instead of batteries.
- Insert/remove the PC serial interface cable after turning off both the camera and your computer.
- Do not remove the memory card while a data is being transferred between the camera and your computer.

■ Automatic Power OFF:

When the data transfer finishes, the mark "⏏" stops blinking.
If no operation is done for 1 hour, the camera will power off automatically.

- To exit the transfer mode, turn off the camera.

Opening the Captured Images

A captured image can be opened and viewed on your computer screen.

1 Click “Open Camera Album” from the Camera menu.

The blinking mark “ P. 45). When the data transfer finishes, the Camera window appears.

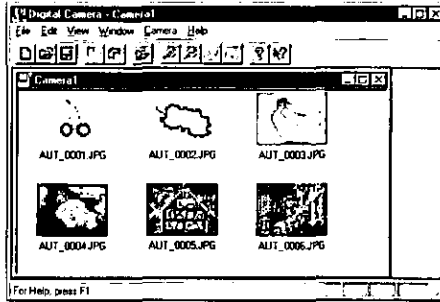

The image files appear as miniature thumbnails in file name (number) order.

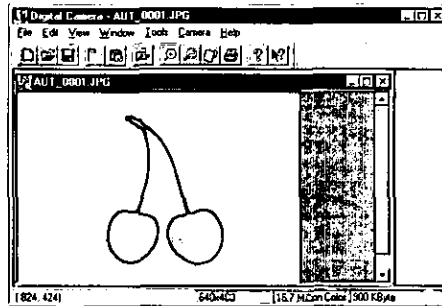

2 Double-click the image file you wish to open.

The image file will be opened.



- To close the image file, click “Close” from the File menu, or click  on the file window.
- To save the image file,  P. 41 “Saving an opened image”.

Saving the Captured Images to the Computer

Save the captured images to your computer when;

- the memory card has become full and you wish to delete the image data on the memory card (P. 26, 28).
- you wish to perform any of the advanced operations, such as editing, pasting, etc. (P. 49-67 “Advanced Operation”).

You can save the desired image(s) from a camera album (below “Saving the desired image(s) from a camera album”), or all images at once without opening the album (P. 48 “Saving all images at once”).

Saving the desired image(s) from a camera album

- 1 Open the camera album (P. 46).

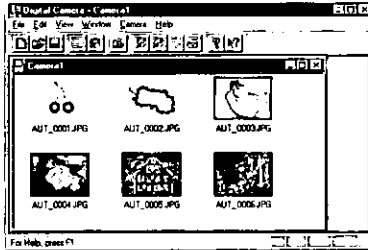

- 2 Select the image(s) you wish to save.
 - To select one, click the image.
 - To select multiple images, click the individual images while holding down **Ctrl**.
 - To select all images, click “Select All” from the Edit menu.

The selected image(s) will be highlighted.

- To cancel the selection(s), move the cursor to any empty space on the camera album window and click.

- 3 Click “Save From Album...” from the File menu.
The “Save From Album” window appears.

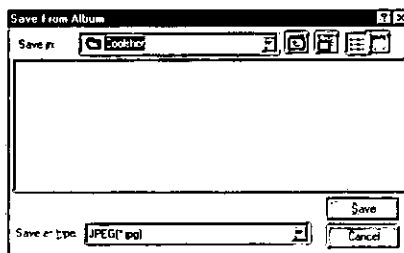

- 4 In the “Save in” dialog box, select the drive and folder where you want to save the images, and click **Save**.

The selected image file(s) will be saved to your computer.

- The file type of the captured image is JPEG. When saving the captured images to a computer, file type cannot be changed.
- Aut_0001.jpg, Aut_0002.jpg ... are the assigned file names for the captured image. To change the saving file name, refer to page 44.

Saving all images at once

- 1 Click “Save Camera Images To Disk...” from the Camera menu.

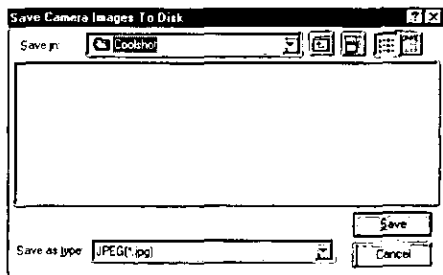

The “Save Camera Images To Disk” window appears.



- 2 In the “Save in” dialog box, select the drive and folder where you want to save the images, and click **Save**.

All image files will be saved to your computer.

Opening Images Saved on the Computer

You can open an image saved on a computer either from a list ( below “Opening an image from a list”) or from an album (miniature thumbnails) ( P. 50 “Opening an image from an album”).

The opened image can be edited, printed or pasted.

Opening an image from a list

1 Click “Open...” from the File menu.

The “Open” window appears.

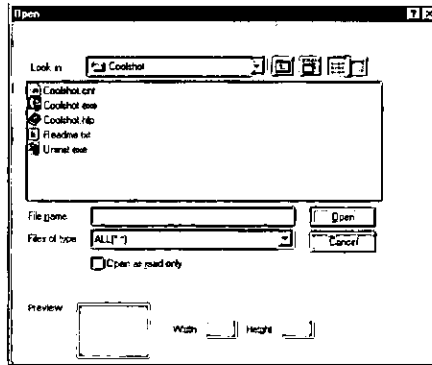

2 In the “Files of type” dialog box, select the file type of the image you wish to open.

In the “Look in” dialog box, select the drive and folder where the image is saved.





A list of file name appears.

3 Click the file name you wish to open.

The selected image appears in the preview screen.

4 Click **Open**.

The image file will be opened.

- To close the image file, select “Close” from the File menu, or click  on the file window.
- To edit the image,  P. 51.
- To print the image,  P. 56.
- To paste the image into other application,  P. 58.

Opening an image from an album

1 Click “Open Album...” from the File menu.

The “Open Album” window appears.

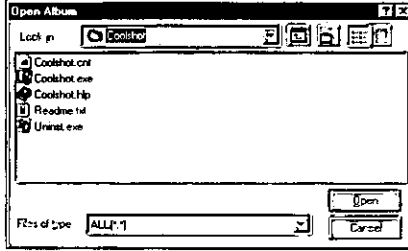

2 **1** In the “Files of type” dialog box, select the file type of the image you wish to open.

2 In the “Look in” dialog box, select the drive and folder where the image is saved.

A list of file name appears.



3 Click **Open**.

The Album window appears.

The image files appear as miniature thumbnails.











4 **Double-click** the image file you wish to open.

The image file will be opened.

- To close the image file, select “Close” from the File menu, or click on the file window.
- To edit the image,  P. 51.
- To print the image,  P. 56.
- To past the image into another application,  P. 58.

Editing an Image

You can edit an image by selecting one of the following functions from the Tools menu.

- Adjusting Colors ( below)
- Adjusting Contrast ( P. 52)
- Adjusting Brightness ( P. 52)
- Rotating the image ( P. 53)
- Trimming ( P. 54)
- Sharpening the image ( P. 54)
- Softening the image ( P. 54)
- Mosaic ( P. 54)
- Changing the image size ( P. 55)
- Selecting the 24 bit color image ( P. 55)

Note:

- You can edit not only the image data captured by the camera but the image data supplied by your computer or other applications. However, to edit an image, the image must be 24 bit color (16.7 million colors). If it is less than 256 colors, change to 24 bit color in advance ( P. 55).

Before editing an image, open the image you wish to edit ( P. 49, 50).

Adjusting Colors

1 Click “Color...” from the Tools menu.

The “Adjust Color” window appears.

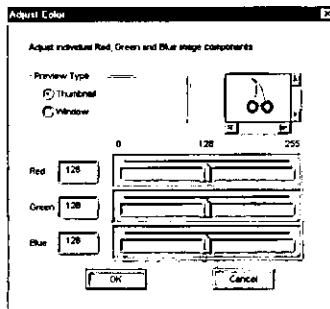

2 Adjust the color.

Slide any bar in Red, Green or Blue left or right by dragging, or enter a numerical value (0-255).

■ “Preview Type” box:

- **Thumbnail:** Displays the whole image as miniature thumbnail.
- **Window:** Displays only a part of the image. You can view the other parts of the image by using scroll bar.

3 Click **OK**.

- To return to the previously edited image, select “Undo” from the Edit menu.

Adjusting Contrast

- 1 Click “Contrast...” from the Tools menu.
The “Adjust Contrast” window appears.

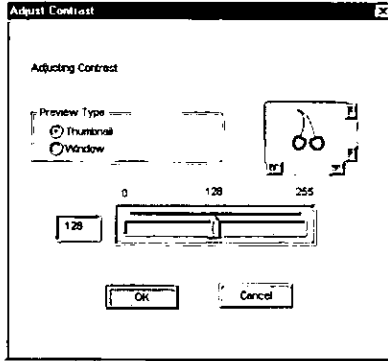

- 2 Adjust the contrast.
Slide the bar left or right by dragging, or enter the numerical value (0-255).

■ “Preview Type” box: P. 51 “Adjusting Colors”.

- 3 Click **OK**.

- To return to the previously edited image, select “Undo” from the Edit menu.

Adjusting Brightness

- 1 Click “Brightness...” from the Tools menu.
The “Adjust Brightness” window appears.

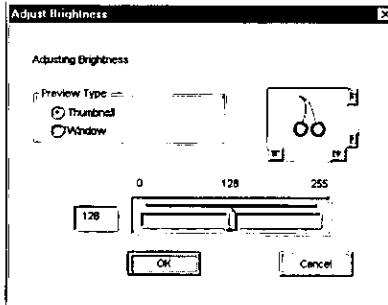

2 Adjust the brightness.

Slide the bar left or right by dragging, or enter the numerical value (0-255).

■ “Preview Type” box:  P. 51 “Adjusting Colors”.

3 Click .

- To return to the previously edited image, select “Undo” from the Edit menu.

Rotating the image

1 From the Tools menu, point to “Rotate”, and click your desired selection.

Selections	Functions
180 Degrees	Turns the image up-side down.
90 Degrees [Right]	Rotates the image 90° clockwise.
90 Degrees [Left]	Rotates the image 90° counterclockwise.
Free Rotate	The “Rotate” window appears. Enter the angle (1-359 degrees), select the direction, and click <input type="button" value="OK"/> .
Use Mouse	Rotates the image by dragging the image from any point to the desired point.

- To return to the previously edited image, select “Undo” from the Edit menu.

Trimming

You can cut off any undesired part of the image by trimming the image.

- 1 Frame the necessary part of the image by dragging the mouse.**
The selected area will be framed.

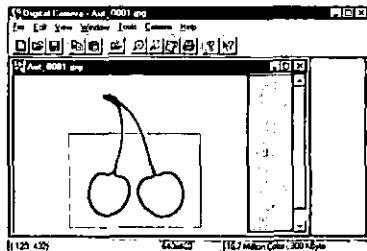

- 2 Click "Trimming" from the Tools menu.**
The image will be trimmed.
 - To return to the previously edited image, select "Undo" from the Edit menu.

Sharpening the image

- 1 Click "Sharpen" from the Tools menu.**
The image will be sharpened.
 - To return to the previously edited image, select "Undo" from the Edit menu.

Softening the image

- 1 Click "Soften" from the Tools menu.**
The image will be softened (out of focus).
 - To return to the previously edited image, select "Undo" from the Edit menu.

Mosaic

- 1 Select the area you wish to mosaic by dragging the mouse.**
If you wish to mosaic the whole image, skip this step.
- 2 Click "Mosaic" from the Tools menu.**
The image will now have a mosaic appearance.
 - To return to the previously edited image, select "Undo" from the Edit menu.

Changing the image size

You can change a number of the pixel (Width × Height).

1 From the Tools menu, point to “Picture Size” and click your desired selection.

The image size is displayed in the status bar in pixels.

Selections	Functions
1/4	Reduces the currently displayed image size to 1/4.
1/2	Reduces the currently displayed image size to 1/2.
2 *	Magnifies the currently displayed image size by two times.
4 *	Magnifies the currently displayed image size by four times.
Fit Camera Size	Changes the image size to the Camera Size to play the image on the camera. An image smaller than 320 × 240 pixels will be changed to 320 × 240 pixels and an image bigger than 320 × 240 pixels will be changed to 640 × 480 pixels. Mainly this is selected when the image file is transferred to the camera.

Editing an Image
(Changing Image Size/Selecting 24 Bit Color)

- * An image can be enlarged up to maximum 1280 × 1024 pixels.
- To return to the previously edited image, select “Undo” from the Edit menu.

Note:

- When the image is magnified, the number of the pixels increases. As the number of the pixels increases, the size of pixels become bigger and the displayed image will become rougher.

Selecting the 24 bit colors image

This selection is effective only when the color of the image is not 24 bit colors.

1 Click “24 bit colors” from the Tools menu.

The image will be displayed in 24 bit colors.

Notes:

- The image edited using this supplied application software can be saved only in 24 bit colors.
- Using 24 bit colors occupies more memory than when using less than 256 colors.
- To return to the previously edited image, select “Undo” from the Edit menu.
- To return to the previously edited image, select “Undo” from the Edit menu.

Advanced Operation
(Common)

Printing Image(s)

Before printing image(s)

Printer setting must be done before printing image(s).
Follow the instructions below.

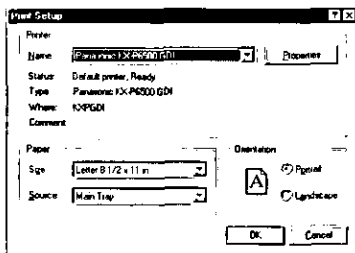

- 1 Click "Printer Settings..." from the File menu.
The "Print Setup" window appears.



- 2 Select the printer, paper size, paper source and orientation.
For detailed information, refer to your printer's manual.
- 3 Click **OK**.

Printing image(s)

Note:

- The image of a camera album ( P. 46) cannot be printed directly. Before printing the image, you must save the image to the computer ( P. 47) and open it from a computer ( P. 49).

- 1 Open the image or album you wish to print ( P. 49, 50).
- 2 Click "Print..." from the File menu.
The "Print" window appears.

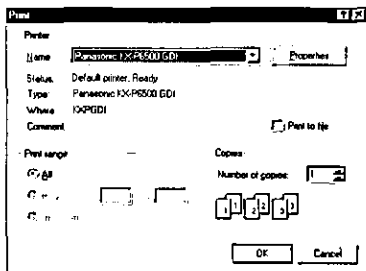

3 Select the printer, print range and the number of copies.

You can confirm in the Preview screen how the image will be printed out ( below "Preview").

4 Click .

The printer starts printing.

Regardless of the image size, the opened image will be printed from edge to edge on the selected paper size.

Preview

Before printing image(s) you can confirm in the Preview screen how the image will appear when it is printed out.

To open the Preview screen, follow the step below.

1 Click "Preview" from the File menu.

The "Preview" screen appears.

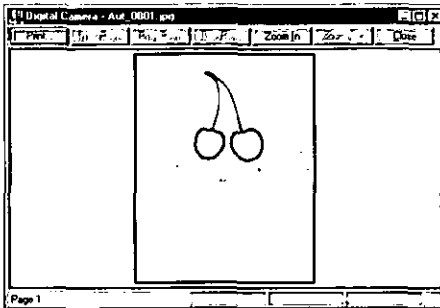

- Zoom In** – Enlarges the image size.
- Zoom Out** – Returns to the original image size.
- Print** – Opens the "Print" window ( P. 56).

Pasting an Image into Another Application

An image can be pasted into another application which supports OLE. Make sure that the application where you wish to paste the image is opened.

- 1 Open an image** ( P. 49, 50).
- 2 Select the area of the image you wish to paste by dragging the mouse.**
The selected area will be framed.

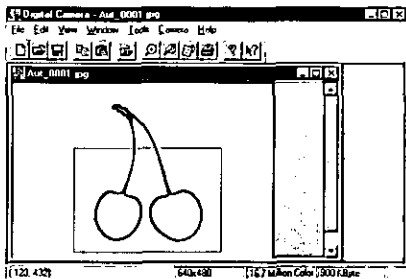

- To select the entire image, click "Select All" from the Edit menu.
- To cancel the current selection, press **Esc**.

- 3 Click "Copy" from the Edit menu.**
- 4 Paste the image into the application by using its pasting function.**
 - To edit the image pasted on the application, double-click on it. The supplied application software will be engaged.

Note:

- If the display color is less than 256 colors, the pasted image may appear faded or washed out.

Saving an Edited Image to the Memory Card

Save the edited image to the memory card when you wish to play it on TV screen, or 1.8" Color LCD Viewfinder (option).

When Using the PCMCIA Adapter

Saving an opened image

- 1 Open an image (P. 49, 50).
- 2 From the Tools menu, point to "Picture Size" and click "Fit Camera Size".

Before saving the image, the image size should be adjusted to the appropriate Camera size.

- 3 Click "Save As..." from the File menu.
The "Save As" window appears.

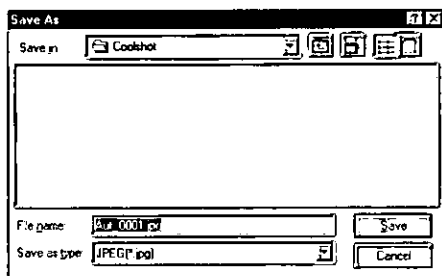

- 4 In the "Save In" dialog box, select the drive letter assigned for the memory card and double-click the "Dc97" folder icon.
- 5 In the "Save as type" dialog box, select "JPEG [* .jpg]".
- 6 In the "File Name" dialog box, type **AUT_XXXX.jpg**.

XXXX : type the file number using 4 digits.

Files must be named like this: AUT_0001.jpg, AUT_0002.jpg, AUT_0003.jpg in the order you want them to play back in the camera. "AUT_" should be typed in the first four digits, and the file number in the last four digits. Do not use a file name other than "AUT_", or it will not be played on the camera.

- 5 Click **Save**.

Saving an Edited Image to the Memory Card

Saving the image(s) from an album

The image(s) must be changed to the camera size and named as "AUT_XXXX" to enable it to use.

1 Open an album (P. 50).

The image files changed to the camera size appear as miniature thumbnails.

2 Select the image(s) you wish to save.

- To select all images, click "Select All" from the Edit menu.
- To select multiple images, click the individual images while holding down **Ctrl** .
- To select one, click the desired image.

The selected image(s) will be highlighted.

3 Click "Save From Album" from the File menu.

The "Save from Album" window appears.

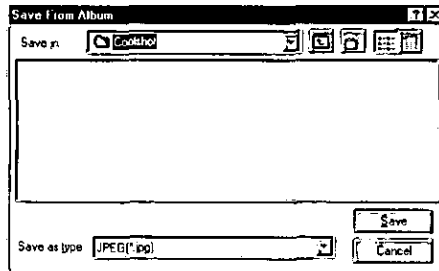

4 In the "Save in" dialog box, select the drive letter assigned for the memory card, and double-click the "Dc97" folder icon.

5 Click **Save** .

The number of images you can save on a memory card varies depending on the individual image sizes.

Saving an Edited Image to the Memory Card
(When Using PCMCIA Adapter)

Advanced Operation
(Common)

When Using the PC Serial Interface Cable

When saving the image(s) to the memory card using the PC serial interface cable, the image size and file type will be modified automatically to the format which can be played on the camera.

- The number of images you can save on a memory card varies depending on the individual image sizes.
- When you save an image to a memory card, it will be saved at the end of the list of files already exist on the memory card.

Saving an opened image

- 1 Open an image ( P. 49, 50).
- 2 Click “Save To Camera” from the Camera menu.

Saving the image(s) from an album

- 1 Open an album ( P. 50).
- 2 Select the image(s) you wish to save.
 - To select all images, click “Select All” from the Edit menu.
 - To select multiple images, click the individual images while holding down **Ctrl**.
 - To select one, click the image.
The selected image(s) will be highlighted.
 - To cancel the selection(s), move the cursor to any empty space on the album window and click.
- 3 Click “Save To Camera” from the Camera menu.

Displaying Images One After Another (Slide Show)

Note:

- Images must be saved on the computer's hard disk drive, or on a memory card in the computer PC card slot for this function to operate. This function is not effective for the camera album opened using the PC serial interface cable.

- 1 Open an album (P. 50).
- 2 Click "Slide Show..." from the Tools menu.
The "Slide Show" window appears.

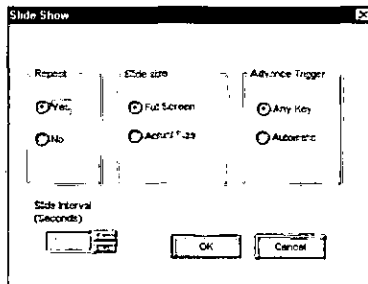

- 3 Select the settings, and click **OK**.
 - To stop the slide show, press **Esc**.

Slide Show Option Setting

■ Repeat:

- Yes** – Displays all images repeatedly until **Esc** is pressed.
- No** – Displays all images once and exits the operation.

■ Slide size:

- Full Screen** – Displays the image in full size.
- Actual Size** – Displays the image in real size.

■ Advance Trigger:

Any Key – Displays another image manually using the keyboard.

- To advance to next image, press **→** or **→**.
- To reverse to previous image, press **←**.
- To display the first image, press **↑**.
- To display the last image, press **↓**.

Automatic – Displays the images automatically. Select the slide interval (0-100) in the Slide Interval box by clicking **▲**, **▼**. The Slide Interval is set in seconds, but it may take a little longer depending on the computer.

- To pause, press **Space key**. To restart displaying, press **Space key** again.

Deleting Image Data

You can delete the image data when;

- the image data has become corrupt.
- you wish to delete unwanted images.
- the memory card becomes full and you wish to reuse the same memory card.

Note:

- The camera images in the album opened using the PC serial interface cable (P. 46) cannot be deleted. Delete them by using the controls on the camera itself (P. 26, 28).

1 Open an album (P. 39, 50).

2 Select the image(s) you wish to delete.

- To select all, click “Select All” from the Edit menu.
- To select multiple images, click the individual images while holding down **Ctrl**.
- To select one, click the image.

The selected image(s) will be highlighted.

- To cancel the selection(s), move the cursor to empty space on the Album window and click.

3 Click “Delete” from the Edit menu.

The “Confirm File Delete” window appears.

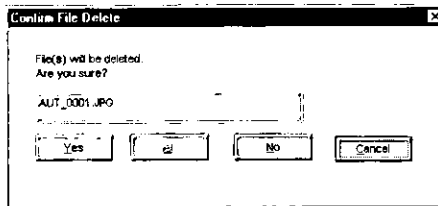

4 ■ If you have selected a single image, click **Yes**.

- If you have selected more than one image, click **All**.*

* If you click **Yes** instead of **All**, you can confirm the file name before deleting it.

Other Functions

Viewing the attribute information of an image file

The information on an opened image (file name, data type, file size, creation date, resolution, color depth and comment) can be viewed.

- 1 Open an image (P. 49, 50).
- 2 Click “Photo Properties...” from the Edit menu.
The “Photo Properties” window appears.

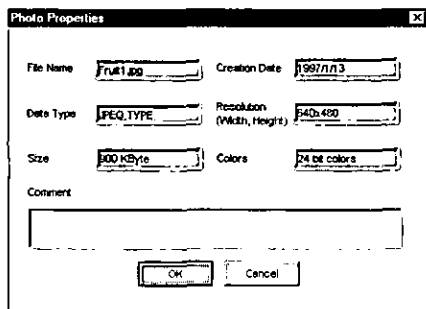

■ Comment:

If the file type is JPEG, you can enter personal comments, such as the captured date or place.

■ Creation Date:

The date of JPEG file creation is “1997.1.1” when it is initially stored on the memory card. Once the image is moved from the card (or camera) and save to the computer’s hard disk drive, it will be time stamped with the computer’s current date.

Note:

- You cannot change the information in the Photo Properties window except the information in the comment window.

Opening more than one image at once

Note:

- This function is effective only under the Windows 95 operating system.

- 1 Open an album ( P. 50).
- 2 Click the images you wish to open while holding down **Ctrl** .
The selected images will be highlighted.
 - To select all images, click "Select All" from the Edit menu.

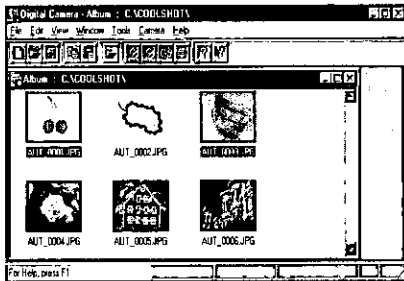

- 3 Drag and drop any one of the selected images to any empty space on the window.
The images will be opened one by one.

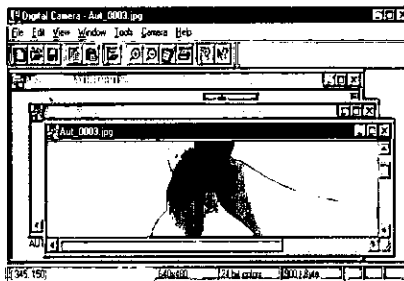

- To display the opened images on top of each other, or in rows,  P. 66 "Displaying the opened images".

Enlarging or Reducing the opened image

- 1 From the View menu, point to “Zoom In / Out”, and select 50%, 75%, 100%, 150%, or 200%.

The currently displayed image will be enlarged/reduced according to the selection.

Displaying the opened images

The opened images can be displayed on top of each other, or in rows.

- To display on top of each other, click “Cascade” from the Window menu.

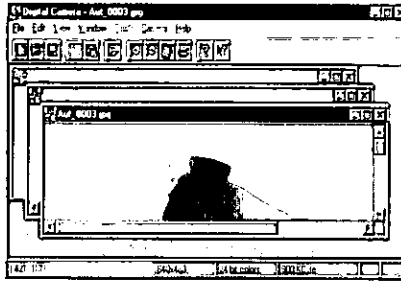

- To display in rows, click “Tile” from the Window menu.

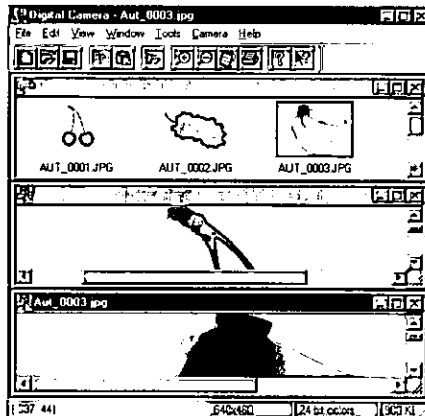

Opening a camera album quickly

A camera album can be opened quickly with only file names on it (The thumbnails will not appear).

1 Click off “Thumbnail” from the Camera menu.

2 Open the camera album.

It will be opened much quicker than it normally does with the thumbnails on it.

- To display all miniature thumbnails again, click on “Thumbnail” from the camera menu.

Error Display

Error Code on the Camera's LCD Display

■ All modes

Error Code	Cause	Solution
no	Memory card is not inserted or not inserted properly.	Insert the memory card into the camera properly (P. 13).
	There is no image data on the memory card.	Capture an image first (P. 15).
LO I	Batteries are used up.	Replace the batteries with new ones (P. 14).
U I I	Memory card is inserted upside down, or an incompatible memory card is inserted.	Insert the memory card properly, or replace it with a compatible memory card (P. 13, 79).
FX Characters or numbers	System error.	Contact your dealer or technical support (back cover).



■ Photography mode

Error Code	Cause	Solution
FULL	Memory card is full.	Replace it with an empty one, or after saving the image data to your computer (P. 41 or 47) if necessary, erase all images on the memory card (P. 28 or 63).

■ Playback/Transfer mode

Error Code	Cause	Solution
U I I	A corrupt image, due to accidental removal of the memory card while image data was being erased, etc., is played back or transferred.	Erase the corrupt image (P. 26 or 63), or reformat the memory card (P. 73) after saving the other image data to a computer if necessary.
U I I	Incompatible JPEG File is played back or transferred.	Change the image size to the Camera Size (P. 59) and save it.

Error Message on the Computer Screen

Error Message	Possible Cause	Solution
This is not a valid file type.	The image file type cannot be recognized.	Change the file type to a compatible one by using image conversion software (not supplied).
Not enough memory.	Memory is insufficient.	Exit other application program or increase the virtual memory. Refer to the Readme file (P. 33) for details.
File is "Read-only". Save with different file name.	Cannot write on a Read Only Memory file.	Enter another name and save it (P. 38, 41).
Failed to communicate.	Camera is OFF.	Turn on the camera.
	Batteries are used up.	It is recommended to use the AC adapter (option) instead of batteries.
	The camera is not in the Photography or Playback mode.	Press  repeatedly until the photography mark "  " or the playback mark "  " appears on the camera's LCD display.
	PC serial interface cable is not connected properly.	Connect the PC serial interface cable properly (P. 43).
	Wrong communication port is selected.	Select the correct communication port (P. 44).
	The port assigned for the PC serial interface cable is used by other application software.	Refer to your computer manual, and check communication port settings.
	The PC serial interface cable is damaged.	Consult the store from which the camera was purchased.
		(P. 33 "Readme file")
No data in camera.	You have not captured any image yet.	Capture an image first then open the image files from the camera.

Error Display
(Error Message on Computer Screen)

Camera
Maintenance

(continued)

Error Display

Error Message	Possible Cause	Solution
Memory card is full.	When saving the image data from a computer to the memory card, available memory is insufficient in the memory card.	Save the data from the memory card to a computer (P. 41 or 47), and erase all the data from the memory card (P. 28 or 63).
Clipboard data is too large.	The image size on clipboard is too large.	Reduce the image size and copy it to the clipboard again.
Rotate Image failed ! Out of system memory !	Memory is insufficient.	Increase the available memory by exiting other application programs etc.
Cannot save JPEG file with this color condition. Convert to 24 bit colors.	The image file is not 24 bit colors.	Select 24 bit colors (P. 55), then save.
Cannot save TIFF file with this color condition. Convert to 24 bit colors.		
Cannot save BMP file with this color condition. Convert to 24 bit colors.		
Disk is full. Insert a new disk.	There is no space on the disk where the files can be saved.	Replace the disk with empty one or change to a different disk (hard disk, etc.).
Memory card is probably changed. Read camera album again if you open it.	When the camera album is opened, the memory card is removed from the camera, or the camera is turned off.	Close the camera album and reopen it.

Error Display
 (Error Message on Computer Screen)

Care and
 Maintenance

Troubleshooting

If trouble occurs, check the following points before returning the camera for service.

Camera Issues

Trouble	Possible Cause	Solution
Turn on the POWER switch, but nothing appears on the LCD display.	The alkaline batteries are not installed correctly, or used up.	Install the alkaline batteries correctly, or replace with new batteries (P. 14).
The power of camera goes off automatically.	The camera has entered in the Automatic Power OFF mode.	Hold up the Power switch to turn on the camera (P. 15).
The camera cannot be turned off.	System lockup.	Remove the alkaline batteries and/or disconnect the AC adapter (option). Reinstall the batteries and/or connect the AC adapter again.
Camera, alkaline batteries, AC adapter (option) or memory card is warm.		This is not abnormal. If they become extremely hot, consult your dealer or technical support (back cover).
Out of focus.	Focus lever is not adjusted properly.	Adjust the focus lever (P. 19).
Image is dark.	ND filter lever is set to ON.	Set the ND filter lever to OFF (P. 19).
	Under-exposure.	Adjust the exposure properly (P. 21).
Rough lines and/or dots appear in the image and it is hard to see the image.	Camera is being used near a magnetic appliance like TV.	Use the camera away from a magnetic appliance.
The camera does not beep.	The beep sound is set to OFF.	Set the beep sound to ON (P. 22).
An image cannot be captured.	The camera is off.	Turn on the camera.
	The photography mark " " or Self-Timer mark " " is not displayed.	Press ^{MODE} until either of the marks appears.
	An error code appears on the LCD display.	(P. 68 "Error Display")

(continued)

Troubleshooting

Trouble	Possible Cause	Solution
A shining line (such as green, white, etc.) or unnatural colors appear on the captured image.	This occurs because of the sensitive characteristic of the camera.	Set the ND filter lever to ON or decrease the exposure index (P. 21, 23).
Ready indicator is off.	The camera is detecting the light level.	Wait for a moment.
Image does not appear on TV .	The playback mark "▶" is not displayed on the LCD display.	Press  repeatedly until "▶" appears on the LCD display.
	Incompatible TV video cable is used.	Use the included TV video cable.
	The TV video cable is not connected properly.	Connect the TV video cable properly (P. 24).
	TV is not switched to proper video mode (video 1, 2, etc.).	Switch the TV to proper video mode.
	An error code appears on the LCD display.	(P. 68 "Error Display").
	The TV video cable is damaged.	Consult the store from which the camera was purchased.

Software Issues

Trouble	Possible Cause	Solution
Memory card is not recognized.	PC card driver and/or ATA PC card driver are/is not installed properly.	Install the PC card driver and/or ATA PC card driver properly (your computer manual).
		(P. 33 "Readme file")
An image cannot be edited.	The image is not 24 bit colors.	Select 24 bit colors (P. 55).
Displayed image is not clear.	The color of the display is less than 256 colors.	Set the color of the display more than 256.
Printed image is not clear.		(P. 33 "Readme file")

Reformatting the Memory Card

If the error code “E12” is displayed on the LCD display, an image cannot be captured in the memory card properly. Reformat the memory card by performing the following steps.

Notes:

- If you reformat the memory card with the image data stored, all the stored images will be deleted.
- When the blinking battery indicator “” appears on the LCD display, you cannot reformat the memory card. Replace the batteries with new ones or use the AC adapter (option), and then reformat the memory card.

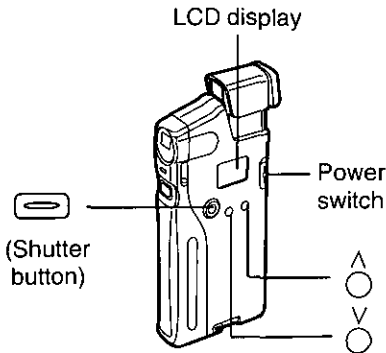

Make sure that the memory card is inserted into the camera.





If you reformat the memory card, the camera will reset the image quality to Fine mode and the beep sound to ON.

Note:

- If  (Shutter button) is not pressed within 5 seconds while “E12” is blinking, the camera will enter the photography mode. To reformat the memory card, turn off the camera and perform steps 1 and 2 again.

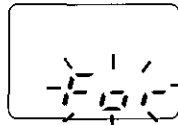
- 1 While holding down both  and , turn on the camera.**
The blinking message “E12” appears on the LCD display.



- 2 While “E12” is blinking (within 5 seconds), press  (Shutter button).**
The blinking erase mark “” appears. While it is blinking, the memory card is being reformatted.

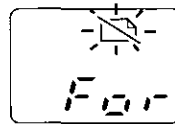

When reformatting is finished, the camera will enter the Photography mode.

Maintenance

Outside of the Camera (Lens cover, LCD display, etc.)

Notes:

- Do not use benzine, thinner, alcohol etc, or they may damage the camera.
- Always keep the lens cover clean for best image quality.

Clean the outside of the camera with a soft, dry cloth.

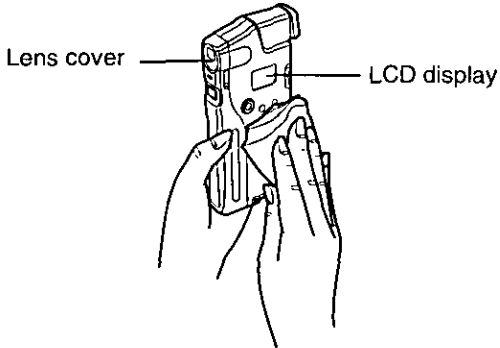

Viewfinder

Note:

- The parts indicated ① and ② tend to be dusty and dirty. Periodic cleaning is recommended.

Clean the viewfinder with a lens blower for camera (not supplied).

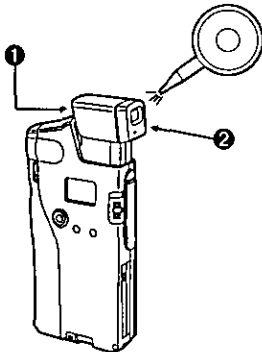

End-User License Agreement

THIS IS A LEGAL AGREEMENT BETWEEN YOU AND PANASONIC. CAREFULLY READ ALL THE TERMS AND CONDITIONS OF THIS AGREEMENT PRIOR TO OPENING THE PACKET OF SOFTWARE PROGRAM. OPENING THE PACKET INDICATES YOUR ACCEPTANCE OF THESE TERMS AND CONDITIONS. If you do not agree to these terms and conditions, return the unopened packet and the other components of the Panasonic product to the place of purchase and your money will be refunded. No refunds will be given for the product that have an opened packet or missing components.

1. COPYRIGHT:

Panasonic has the right to license or has been granted to license the enclosed software program ("SOFTWARE"), developed and copyrighted by Kyushu Matsushita Electric Co., Ltd. or its licensor ("Licensor"). You acknowledge that you are receiving only a LIMITED LICENSE TO USE the SOFTWARE and related documentation, and that you shall obtain no title, ownership nor any other rights in or to the SOFTWARE and related documentation, all of which title and rights shall remain with Licensor and Panasonic.

2. LICENSE:

(1) You have the non-exclusive right to use the one copy of the SOFTWARE on a single computer used by single user. Installation of the SOFTWARE on a network server for the purpose of distribution to one or more other computers shall not be granted in this Agreement. (2) You may not copy, reproduce, or permit to be copied or reproduced, the SOFTWARE or related documentation for any purpose, except that you may either (a) make a reasonable quantity of copies of the SOFTWARE solely for backup or archival purposes, or (b) transfer the SOFTWARE to a single hard disk, provided that you keep the original solely for backup or archival purposes. All other copies of the SOFTWARE are in violation of this Agreement. (3) You may not rent or lease the SOFTWARE, but you may transfer your right under this License Agreement on a permanent basis, provided that you transfer this Agreement, all copies of the SOFTWARE, all related documentation and your Panasonic product, and the recipient thereof agrees the terms of this Agreement. (4) You may not reverse engineer, decompile or disassemble the SOFTWARE, except that in European Union and European Free Trade Association, you may have the limited right to reverse engineer, decompile or disassemble the SOFTWARE solely to the extent specifically permitted by the terms and conditions of Article 6 of the European Community's Directive for the Legal Protection of Computer Programs, OJL 122/42 (17 May 1991). (5) You may not use, copy, modify, alter, or transfer the SOFTWARE, or any copy thereof, in whole or in part, except as expressly provided in this Agreement.

3. TERM:

This license is effective until terminated. You may terminate this Agreement at any time by destroying the SOFTWARE and related documentation and all copies thereof. This license will also terminate if you fail to comply with any term or condition of this Agreement. Upon such termination, you agree to destroy all copies of the SOFTWARE and related documentation.

End-User License Agreement

4. LIMITED WARRANTY:

Within ninety (90) days of your receipt of the SOFTWARE, Panasonic warrants that the storage media on which the SOFTWARE are furnished is free from defect in materials and workmanship under normal use, and that it will repair or at its option replace any defective media at no charge to you, provided that such defective media is returned to Panasonic within such ninety (90) days period.

5. LIMITATION OF LIABILITY:

EXCEPT AS STATED ABOVE, NEITHER PANASONIC NOR PANASONIC'S SUPPLIER MAKES OR PASSES ON TO YOU OR OTHER THIRD PARTY, ANY WARRANTY OR REPRESENTATION INCLUDING, BUT NOT LIMITED TO, THE IMPLIED WARRANTY OF MERCHANTABILITY AND FITNESS FOR A PARTICULAR PURPOSE. WITHOUT LIMITING THE GENERALITY OF THE FOREGOING, NEITHER PANASONIC NOR PANASONIC'S SUPPLIER WARRANTS THAT THE SOFTWARE WILL BE ERROR-FREE OR THAT IT WILL MEET YOUR REQUIREMENTS. NEITHER PANASONIC NOR PANASONIC'S SUPPLIER SHALL BE LIABLE FOR ANY DAMAGE SUFFERED BY YOU INCLUDING, BUT NOT LIMITED TO, CONSEQUENTIAL, INCIDENTAL SPECIAL OR PUNITIVE DAMAGES. THE ABOVE LIMITATIONS SHALL APPLY REGARDLESS OF THE FORM OF ACTION WHETHER IN CONTRACT, TORT (INCLUDING NEGLIGENCE), STRICT PRODUCT LIABILITY OR OTHERWISE, EVEN IF SUCH PARTY HAS BEEN ADVISED OF THE POSSIBILITY OF SUCH DAMAGES.

Specifications

Operating Environment (Under no damp or moist conditions):	Temperature: 0°C {32°F} to 40°C {104°F} Humidity: 20% to 80% RH						
Storage Environment (Non-condensing):	Temperature: -20°C {-4°F} to 55°C {131°F} Humidity: 15% to 85% RH						
Dimensions:	134 (H) × 69 (D) × 25 (W) mm {5.28" × 2.7" × 0.98"}						
Mass {Weight}:	Approx. 140 g {0.31 lbs.} (without batteries) Approx. 182 g {0.40 lbs.} (with batteries)						
Power Source:	<ul style="list-style-type: none"> Alkaline "AAA" Size Batteries (4) AC Adapter (KX-WZ502, option) 						
Battery Life * [at 20°C {68°F}]:	<p>■ When using Panasonic "AAA" size alkaline batteries continuously</p> <table border="1"> <tr> <td>Photography & Playback alternately for 1 min.</td> <td>Approx. 60 min.</td> </tr> <tr> <td>Photography only</td> <td>Approx. 40 min.</td> </tr> <tr> <td>Playback only</td> <td>Approx. 80 min.</td> </tr> </table>	Photography & Playback alternately for 1 min.	Approx. 60 min.	Photography only	Approx. 40 min.	Playback only	Approx. 80 min.
Photography & Playback alternately for 1 min.	Approx. 60 min.						
Photography only	Approx. 40 min.						
Playback only	Approx. 80 min.						
Interface:	PCMCIA Type II (with use of the included PCMCIA Adapter) Digital IN/OUT Jack: Serial Interface (connected with the included PC serial interface cable) Video Output Jack: Mini Jack NTSC Color 1V P-P, 75 Ω (connected with the included TV video cable)						
TV Video Cable:	Plug: φ 3.5 Mini Stereo Plug, RCA Pin Jack Length: Approx. 1.4 m {4.59 ft.}						
Compact Memory Card:	Power Source: <ul style="list-style-type: none"> When inserted into the camera DC 3.3 V, approx. 60 mA When inserted into a computer DC 5 V, approx. 150 mA (max.) Card Type: PCMCIA-ATA Compatible Capacity: <ul style="list-style-type: none"> 2 MB Compact Memory Card Fine Mode (High Resolution): 24 images Normal Mode (Normal Resolution): 96 images 4 MB Compact Memory Card Fine Mode (High Resolution): 48 images Normal Mode (Normal Resolution): 192 images Dimensions: 3.3 (H) × 36.4 (D) × 42.8 (W) mm {0.13" × 1.4" × 1.69"}						

* Battery life may be shortened depending on the operating condition. (continued)

Specifications

Recording Format:	JPEG Image Compression
Capture CCD:	1/4" Non-Interlaced Progressive Scan CCD Total pixels: 360,000 Valid pixels: 320,000
Resolution:	Fine Mode (High Resolution): 640 × 480 pixels, 24 bit colors Normal Mode (Normal Resolution): 320 × 240 pixels, 24 bit colors
Image Processing:	Normal Resolution: Approx. 0.5 sec. interval High Resolution: Approx. 1.0 sec. interval
Self-Timer:	Approx. 10 sec. Automatic Shutter Release
Lens:	Fixed Focal Length: f=5.2 mm (Equivalent to a 50 mm Lens on 35 mm SLR Film Camera.) F Stop No.=2.8 mm
Focus Adjustment Range:	Macro Mode (Close Range): 13 - 15 cm {5.12"- 5.91"} Portrait Mode (Med. Range): 50 cm - 1 m {19.69"- 39.37"} Normal Mode (Long Range): 1 m - infinity {39.37"- infinity}
Exposure Control:	Automatic
Exposure Adjustment:	User Override Adjustments from Compensation -2.0 to +2.0 (in 0.5 step increments)
Shutter Speed:	1/15 sec. to 1/4000 sec. (Automatic)
White Balance:	Automatic White Balance Control
CCD ISO:	Equivalent to ISO 100
Viewfinder:	Optical Real Image Finder (Pop-up Type)
Setup Application Software:	<ul style="list-style-type: none"> ■ File Type: <ul style="list-style-type: none"> ● Readable Image File Type* BMP (16.7 million, 256, 16, 2 colors), JPEG (16.7 million colors), or TIFF (Decompression 16.7 million colors/ 256 colors) ● Saveable Image File Type BMP (16.7 million colors), JPEG (16.7 million colors), or TIFF (Decompression 16.7 million colors) * Some images cannot be opened. ■ Maximam Image Size: 1,280 × 1,024 pixels

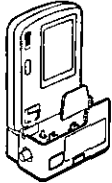
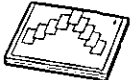
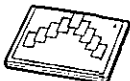

Options

The following options are available through your local Panasonic authorized parts distributor.

Model No.	Model Name	Features
	KXL-D50 1.8" Color LCD Viewfinder	<ul style="list-style-type: none"> ● 1.8" TFT color LCD ● Easily connects to KXL-600A Camera ● Preview images ● Adjusts for convenient viewing angle ● Display stored images ● Convenient way to manage images <p>The Panasonic 1.8" LCD is high resolution, color viewfinder. Preview your images before you capture them. Images can be stored to or deleted from the memory card. The LCD easily connects to the KXL-600A camera and adjusts for convenient viewing. A great way to view and manage images.</p>
	KXL-D51 2 MB Compact Memory Card	<ul style="list-style-type: none"> ● Store 96 images (normal resolution) ● Store 24 images (high resolution) <p>With the 2 MB memory card you can store up to 96 images in normal resolution mode or 24 images in high resolution mode. Save images or delete images. And unlike traditional film, memory cards can be used over and over. Images captured in either normal or high resolution can be stored on the same card.</p>
	KXL-D52 4 MB Compact Memory Card	<ul style="list-style-type: none"> ● Expand your storage capacity ● Store 190 images (normal resolution) ● Store 48 images (high resolution) <p>If you want even more room for your images, the 4 MB memory card can store up to 190 images in normal resolution mode or 48 images in high resolution mode. Save images or delete images. And unlike traditional film, memory cards can be used over and over. Images captured in either normal or high resolution can be stored on the same card.</p>

(continued)

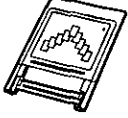
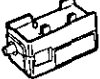
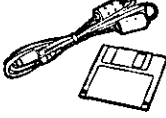
Options





Model No.	Model Name	Features
KXL-D55 	PCMCIA Adapter	<ul style="list-style-type: none">● Industry Standard ATA Type II compatible● Quickly transfer images to PC <p>Transfer images to your PC at approximately hard drive speed.</p>
KXL-D58 	Tripod Adapter	<ul style="list-style-type: none">● Easily mount KXL-600A on your existing tripod● Hands-free image capturing using Self-Timer
KXL-D43 	Macintosh Interface Kit	<ul style="list-style-type: none">● Easily Connects to your Macintosh● Quickly transfer images to your Macintosh
KX-WZ502 	AC Adapter	<ul style="list-style-type: none">● Save your battery life with the AC Adapter● Useful especially for transferring data or playing back images

Index

A

- Adjusting focus 19
- Adjusting Brightness of the displayed image 52
- Adjusting Colors of the displayed image 51
- Adjusting Contrast of the displayed image 52
- Adjusting the exposure index 22
- Advanced photography 20-23
- Advanced software operation 49-67
- Album
 - Opening a camera album 46
 - Opening an album 39
 - Opening an album quickly 67
 - Saving from a camera album 47
 - Saving from an album 42
- Alkaline batteries 5, 9, 14, 15
 - Installation 14
 - Precaution 9
 - Removal 14
- Application Setup Disk 5, 31
- Automatic Power OFF 15, 45
- Avoiding to capture a blurred image 23

B

- Back-up copy 31
- Basic photography 15-19
- Batteries 5, 9, 14
- Battery cover 10, 14, 15
- Battery indicator 11, 14, 28
- Beep sound 11, 22
- Beep sound mark 11, 22
- Blurred image 23
- Buttons
 - MODE () 10
 - Push () 10, 15
 - SELECT () 10
 - Shutter () 10, 17, 20

C

- Camera album 46, 47, 56, 62, 63
- Capturing a brighter/darker image 21

- Capturing Indoors 23
- Capturing Outdoors 23
- Card eject lever 10, 13, 34
- Changing the image size 51, 55
- Communication port 44
- Connecting the camera to TV 24
- Connecting TV video cable 24
- Continuous Image Capture 17

D

- Deleting Image data 63
- Digital IN/OUT jack 10, 43
- Displaying the opened images
 - on top of each other (Cascade) 66
 - in rows (Tile) 66

E

- Editing an image 50-55
- End-user License Agreement 75
- Enlarging/Reducing the image size 55
- Erase mark 11, 26, 28
- Erasing image on camera 26, 28
- Error code on camera 68
- Error message on computer 69
- Exposure 21
- Exposure mark 11, 21
- Eye cap 5, 12

F

- Fine mode 11, 16, 18
- Focus adjustment range 16, 19
- Focus lever 16, 19

H

- How to hold the camera 16

I

Image
 Printing 56
 Deleting 63
 Editing 51
 Pasting 58
 Opening 37-40, 46, 49, 65
 Saving 41, 42, 47, 59-61
 Displaying 62, 66
Image quality 16, 18
Image quality mark 11, 16, 18
Indoor photography 23
Inserting Memory card 13, 34
Inserting PCMCIA adapter 34
Installing batteries 14
Installing software 31

L

LCD display 10, 11
Lens cover 10

M

Macro mode 19
Maintenance 74
Memory Card 5, 13, 34
 Insertion 13, 34
 Reformatting 73
 Removal 13
Memory card slot 10, 13
Microsoft Win32 Setup disks 5, 31
Miniature thumbnails 40, 46, 50, 51
Mosaic 54

N

ND Filter Lever 10, 19, 23
Normal mode 11, 16, 18

O

Opening a camera album 46
Opening a camera album quickly 67
Opening an album 39
Opening more than one image 65
Opening the captured image 37, 46
Opening the image saved to
 computer 49
Opening the Main window 36, 44
Options 79, 80
Outdoor photography 23

P

Package Contents 5
Padded carrying case 5
Part Names and Functions 10
PC serial interface
 cable 5, 10, 43-45, 62, 63
 Connection 43
PCMCIA adapter 5, 34
 Insertion 34
 Removal 35
PCMCIA Type II slot 30, 34
Photography/Playback
 mark 11, 15, 25, 26, 44
Playback an image on TV 25
Positioning an image 19
POWER switch 10, 15, 44
Precautions 8, 9
Preparation 12-14, 44
Printing an image 56
Push button 10, 15

R

Ready indicator 10, 17, 19
Reformatting the memory card 73
Removing batteries 14
Removing Memory card 13
Removing PCMCIA adapter 35
Resolution 18, 38
Rotating the image 51, 53
RS-232C serial interface 30

S

- Saving the captured image
 - to a computer 41, 47
- Saving an edited image
 - to memory card 59
- Selecting 24 bit colors 55
- Self-Timer mode 11, 20
 - indicator 10, 20
 - mark 11, 20
- Setup for a computer with
 - PC card slot (PCMCIA) 31-34
- Setup for a computer with
 - serial interface connector 43
- Slide Show 62
- Sharpening the image 51, 54
- Softening the image 51, 54
- Software installation 31-33
- Specifications 77
- System requirements 30

T

- Transferring a data 44, 45, 46
- Trimming the image 51, 54
- Tripod 20, 23
 - adapter (option) 10, 20, 23, 79
 - guides 10
- Troubleshooting 71, 72
- TV video cable 5, 10, 24

U

- Uninstalling software 33
- Using the Self-Timer 20

V

- Video out jack 10, 24
- Viewfinder 10, 15, 17
- Viewfinder graticule marks 19
- Viewing the attribute information
 - of the opened image file 64

W

- Windows 3.1, 3.11 30, 31, 33-36
- Windows 95 30, 31, 33, 35, 36, 65
- Wrist strap 5, 12, 16

FOR USERS IN CONTINENTAL UNITED STATES ONLY

Technical Support and Service Parts Calls

If you have read this manual and tried the troubleshooting procedures, and you are still having difficulty, please contact the store from which the unit was purchased. Panasonic Computer Peripheral Company will repair this product with new or refurbished parts free of charge for two (2) years from the date of purchase.

You may also call the technical support telephone number (24 hours/7 days).

**The technical support number is: 1-800-PANA-SYS
(1-800-726-2797)**

The service parts number is: 1-800-332-5348

Software drivers are sometimes updated. You can download the latest driver or new setup disk via your modem.

Internet : <http://www.PANASONIC.com/alive>

BBS : @ 201-863-7845

This product is designed for use only in the country where it was purchased.

Panasonic Computer Peripheral Company
Division of Panasonic Communications & Systems Company
A Unit of Matsushita Electric Corporation of America
Two Panasonic Way, Secaucus, New Jersey 07094

Panasonic Sales Company
Division of Matsushita Electric of Puerto Rico, Inc.
San Gabriel Industrial Park, 65th Infantry Avenue KM. 9.5
Carolina, Puerto Rico 00630

Matsushita Electric Industrial Co., Ltd.
Central P.O. Box 288, Osaka 530-91, Japan
