

DOUBLEFEATURE™

Panasonic®



Omnivision **VHS**

DVD/VCR DECK
Operating Instructions

Model No. **PV-D4743/PV-D4743S**



Connections and Initial Setup Procedures are on pages 12 to 17.



MULTI FORMAT PLAYBACK



*Ability to play back may depend on recording conditions.



As an **ENERGY STAR®** Partner, Matsushita Electric Corporation of America has determined that this product or product model meets the **ENERGY STAR®** guidelines for energy efficiency.

Please read these instructions carefully before attempting to connect, operate or adjust this product. Please save this manual.

Spanish Quick Use Guide is included.

(Guía para rápida consulta en español está incluida.)

LSQT0674C

For assistance, please call : 1-800-211-PANA(7262) or send e-mail to : consumerproducts@panasonic.com

Initial Setup
(Connection)

Basic
Operation

VCR
Operation

DVD
Operation

For Your
Information

Important Safeguards and Precautions

FOR YOUR SAFETY, READ AND RETAIN ALL SAFETY AND OPERATING INSTRUCTIONS. HEED ALL WARNINGS IN THE MANUAL AND ON THE UNIT

INSTALLATION

1 POWER SOURCE CAUTION

Operate only from a power source indicated on the unit or in this manual. If necessary, have your Electric Utility Service Company or Video Products Dealer verify the power source in your home.

2 POLARIZED OR GROUNDING PLUG

As a safety feature, this product comes with either a polarized power cord plug (one blade is wider than the other), or a three-wire grounding type plug.

POLARIZED PLUG CAUTION:

This plug will only fit into an outlet one way. If you cannot fully insert the plug, try reversing it. If it still will not fit, have an electrician install the proper wall outlet. Do not defeat the safety feature by tampering with the plug.

GROUNDING PLUG CAUTION:

This plug will only fit into a three-hole grounding outlet. If necessary, have an electrician install the proper outlet. Do not defeat the safety feature by tampering with the plug.

3 POWER CORD

Make sure power cords are routed so that they are not likely to have anything rest on them, roll over them, or be in the way of walking traffic. If an extension cord is used, make sure it also has either a polarized or grounded plug and that the cords can be securely connected. Frayed cords, damaged plugs, and damaged or cracked wire insulation are hazardous and should be replaced by a qualified service technician. Overloaded outlets and extension cords are fire hazards and should be avoided.

4 DO NOT BLOCK VENTILATION HOLES

Ventilation openings in the cabinet release heat generated during operation. If they are blocked, heat build-up inside the unit can cause failures that may result in a fire hazard or heat damage to cassettes or discs.

For protection, follow these rules:

- Never cover ventilation slots or the unit while in use, or operate the unit when placed on a bed, sofa, rug, or other soft surface.
- Avoid built-in installation, such as a book case or rack, unless proper ventilation is provided.

5 PLACEMENT: AVOID EXTREMELY HOT LOCATIONS OR SUDDEN TEMPERATURE CHANGES

Do not place the unit over or near heater or radiator, in direct sunlight, inside closed vehicles, in high temperature [over 104°F (40°C)], or in over 75% humidity. If the unit is suddenly moved from a cold place to a warm one, moisture may condense in the unit and on the tape causing damage. Never subject the unit to vibration, impact, or place it so that the surface is tilted as internal parts may be seriously damaged.

6 TO AVOID PERSONAL INJURY

- Do not place unsecured equipment on a sloping surface.
- Do not place this unit on any support that is not firm, level, and adequately strong. The unit could fall causing serious injury to a child or adult and damage to the unit.
- An appliance and cart combination should be moved with care. Quick stops, excessive force, and uneven surfaces may cause the appliance and cart combination to overturn.
- Carefully follow all operating instructions and use the manufacturer's recommended accessories when operating this unit or connecting it to any other equipment.



2

OUTDOOR ANTENNA INSTALLATION

1 SAFE ANTENNA AND CABLE CONNECTION

If an outside antenna or cable system is connected to the equipment, be sure the antenna or cable system is grounded so as to provide some protection against built up static charges and voltage surges.

Section 810 of the National Electrical Code, ANSI/NFPA 70 (in Canada, part 1 of the Canadian Electrical Code) provides information with respect to proper grounding of the mast and supporting structure, grounding of the lead-in wire to an antenna discharge unit, size of grounding conductors, location of antenna discharge unit, connection to grounding electrodes and requirements for the grounding electrode.

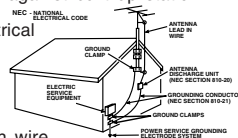

2 KEEP ANTENNA CLEAR OF HIGH VOLTAGE POWER LINES OR CIRCUITS

An outside antenna system should be located well away from power lines, electric light or power circuits and where it will never come into contact with these power sources if it should happen to fall. When installing an outside antenna, extreme care should be taken to avoid touching power lines, circuits or other power sources as this could be fatal. Because of the hazards involved, antenna installation should be left to a professional.

USING THE UNIT

If the unit has been in storage or moved to a new location, refer first to the INSTALLATION section of these safeguards.

1 KEEP THE UNIT AWAY FROM WATER OR MOISTURE OF ANY KIND.

2 IF EQUIPMENT IS EXPOSED TO RAIN, MOISTURE, OR STRONG IMPACT, unplug the unit and have it inspected by a qualified service technician before use.

3 DURING AN ELECTRICAL STORM

During a lightning storm, whether indoors or outdoors, or before leaving the unit unused for extended periods of time, disconnect all equipment from the power source as well as the antenna and cable system.

4 WHEN THE UNIT IS PLUGGED IN

- Never expose the unit to rain or water. DO NOT OPERATE if liquid has been spilled into the unit. Immediately unplug the unit, and have it inspected by a service technician. Fire and shock hazards can result from electrical shorts caused by liquid contact inside.
- Never drop or push any object through openings in the unit. Some internal parts carry hazardous voltages and contact can cause electric shock or fire hazard. Do not put any foreign object on the disc tray.
- Avoid placing the unit directly above or below your TV set as this may cause electrical interference. Keep all magnets away from electronic equipment.

5 USING ACCESSORIES

Use only accessories recommended by the manufacturer to avoid risk of fire, shock, or other hazards.

6 CLEANING THE UNIT

Unplug the unit. Then, use a clean, dry, chemically untreated cloth to gently remove dust or debris. DO NOT USE cleaning fluids, aerosols, or forced air that could over-spray, or seep into the unit and cause electrical shock. Any substance such as wax, adhesive tape, etc. may mar the cabinet surface. Exposure to greasy, humid, or dusty areas may adversely affect internal parts.

SERVICE

1 DO NOT SERVICE THIS PRODUCT YOURSELF

If, after carefully following the detailed operating instructions, this product does not operate properly, do not attempt to open or remove covers, or make any adjustments not described in the manual. Unplug the unit and contact a qualified service technician.

2 IF REPLACEMENT PARTS ARE REQUIRED

Make sure the service technician uses only parts specified by the manufacturer, or those having the same safety characteristics as the original parts. The use of unauthorized substitutes may result in fire, electric shock, or other hazards.

3 HAVE THE SERVICE TECHNICIAN PERFORM A SAFETY CHECK

After any service or repairs to the unit, request the service technician to conduct a thorough safety check as described in the manufacturer's service literature to ensure that the unit is in safe operating condition.

Safety Precautions/Mesures de sécurité

WARNING: To prevent fire or shock hazard, do not expose this equipment to rain or moisture.

CAUTION: To prevent electric shock, match wide blade of plug to wide slot, fully insert.

Avertissement: Afin de prévenir tout risque d'incendie ou de chocs électriques, ne pas exposer cet appareil à la pluie ou à une humidité excessive.

Attention: Pour éviter les chocs électriques, introduire la lame la plus large de la fiche dans la borne correspondante de la prise et pousser jusqu'au fond.

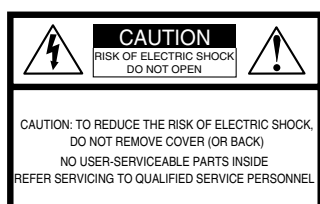

This symbol warns the user that uninsulated voltage within the unit may have sufficient magnitude to cause electric shock. Therefore, it is dangerous to make any kind of contact with any inside part of this unit.



This symbol alerts the user that important literature concerning the operation and maintenance of this unit has been included. Therefore, it should be read carefully in order to avoid any problems.

CAUTION:

UNIT IS A CLASS I LASER PRODUCT. HOWEVER THIS UNIT USES A VISIBLE LASER BEAM WHICH COULD CAUSE HAZARDOUS RADIATION EXPOSURE IF DIRECTED. BE SURE TO OPERATE THE UNIT CORRECTLY AS INSTRUCTED.

WHEN THIS UNIT IS PLUGGED TO THE WALL OUTLET, DO NOT PLACE YOUR EYES CLOSE TO THE OPENING OF THE DISC TRAY AND OTHER OPENINGS TO LOOK INTO THE INSIDE OF THIS UNIT.

USE OF CONTROLS OR ADJUSTMENTS OR PERFORMANCE OF PROCEDURES OTHER THAN THOSE SPECIFIED HEREIN MAY RESULT IN HAZARDOUS RADIATION EXPOSURE.

DO NOT OPEN COVERS AND DO NOT ATTEMPT TO REPAIR YOURSELF. REFER SERVICING TO QUALIFIED PERSONNEL.

CAUTION:

LASER RADIATION WHEN OPEN DO NOT STARE INTO BEAM.

ATTENTION:

RAYONNEMENT LASER EN CAS D'OUVERTURE. NE PAS REGARDER DANS LE FAISCEAU.

(Inside of product)

FCC NOTE:

This equipment has been tested and found to comply with part 15 of the FCC Rules. These limits are designed to provide reasonable protection against harmful interference when operated in a residential environment. If this equipment does cause interference to radio or television reception, which can be determined by turning the equipment off and on, use the equipment in another location and/or utilize an electrical outlet different from that used by the receiver.

If necessary, consult the dealer or an experienced radio/TV technician for help. The user may find the booklet, "Something About Interference" available from FCC local regional offices helpful.

FCC Caution:

To assure continued compliance, (example- use only shielded interface cables when connecting to other devices.) Any changes or modifications not expressly approved by the party responsible for compliance could void the user's authority to operate this equipment.

FCC Warning: Any unauthorized changes or modifications to this equipment would void the user's authority to operate.

Region Management Information:

This DECK is designed and manufactured to respond to the Region Management Information that is recorded on a DVD disc. If the Region number described on the DVD disc does not correspond to the Region number of this DECK, this DECK cannot play this disc.

- The Region number for this DECK is "1".
- The Player will play DVD-Video marked with labels containing "1" or "ALL".

Example:



3

Before Using

Congratulations

on your purchase of one of the most sophisticated and reliable products on the market today. Used properly, it will bring you years of enjoyment. Please fill in the information below. The serial number is on the tag located on the back of your DECK.

- Date of Purchase _____
- Dealer Purchased From _____
- Dealer Address _____
- Dealer Phone No. _____
- Model No. _____
- Serial No. _____

Accessories

- Remote Control
LSSQ0374 (PV-D4743)
LSSQ0375 (PV-D4743S)

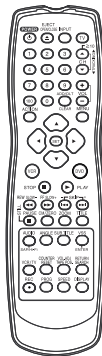

- Batteries 2 "AA"



- RF Coaxial Cable
LSJA0372



To order accessories, call toll free
1-800-332-5368.

Loading the Batteries

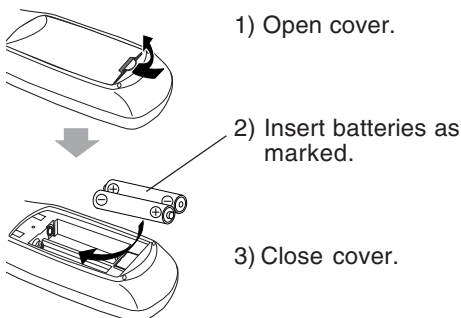

- Battery replacement caution**
 - Do not mix old and new batteries.
 - Do not mix alkaline with manganese batteries.

Disc formats supported by this DECK

DECK can play back discs bearing any of the following marks:
[Discs Played 8cm (3") or 12cm (5")]

Logo	Disc type
	DVD (DVD-Video)
	DVD-R (DVD-Video formatted discs [finalized])
	Video CD
	CD (CD-DA) CD-R/CD-RW (CD-DA, Video CD formatted discs [finalized]) WMA, MP3, JPEG

Discs which cannot be played

- DVD with Region No. other than "1" or "ALL"
- DVD of PAL system, DVD-Audio, DVD-RAM, DVD-ROM, DVD-RW, DVD+RW, CD-ROM, CDV, CD-G, CVD, SVCD, SACD, Divx Video Disc and Photo-CD

Notes

- Do not use irregularly shaped discs (e.g. heart-shaped), as these can damage the unit.
- It may not be possible to play CD-R, CD-RW and DVD-R in all cases due to the type of disc or condition of the recording.

Disc Handling

Handling precautions

- Sticking a label on the disc may impair DVD-R playback.
- Do not attach sticker to discs. (Do not use discs with exposed adhesive from tape or left over peeled-off stickers.)
- Only hold disc by edges as shown below. Fingerprints, dirt and scratches can cause skipping and distortion.
- Do not write on label side of disc.
- Never use record cleaning sprays, benzene, thinner, static electricity prevention liquids, or any other solvent.



- Do not try to close disc tray when disc is not properly placed.

To clean disc surface

With a soft, damp (water only) cloth, gently wipe from the center hole to the outer edge as shown below. (Wiping in a circular pattern will scratch the surface.)

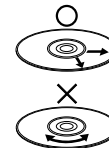

If disc is brought from a cold to a warm environment, moisture may form on the disc

Wipe away moisture with a soft, dry, lint-free cloth before using disc. (See above.)

Improper disc storage

- Discs could be damaged if stored or left in areas:
 - exposed to direct sunlight.
 - that are humid or dusty.
 - near heat (i.e. heater, radiator, etc.).

Table of Contents

DVD / VCR	
Important Safeguards and Precautions	2, 3
Before Using	4
DECK & Cassette Information	6, 7
Location of Controls	8 ~ 10
Displays (On Screen Displays and Multi Function Display)	11
Connections	12 ~ 15
Initial Setup for Basic Connections (Ready to Play)	16, 17
<hr/>	
VCR	
Reset Language, Channels, Clock, VCR's Output Channel ...	18, 19
Playback/ Record on a Tape	20, 21
DVD	
Basic DVD Operation	22, 23
<hr/>	
Timer Recording	24, 25
MTS Broadcast/ VHS Hi-Fi Stereo System	26, 27
Multi-Brand Control Feature	28, 29
Tape Operation (Search System)	30 ~ 32
Special VCR Features	33, 34
Copying Your Tapes (Dubbing)	35
<hr/>	
Disc Operation	36 ~ 40
DVD Operation using On-Screen Displays	41 ~ 42
MP3/WMA/JPEG Playback Operation	43 ~ 45
DVD Lock Feature	46
Settings for DVD Operation	47 ~ 49
Language Code List	50
<hr/>	
DVD / VCR	
Warning and Instruction Displays	51
Before Requesting Service	52, 53
Limited Warranty	54, 55
Customer Services Directory	55
Spanish (Español) Quick Use Guide	56 ~ 61
Index	62, 63

Initial Setup
(Connection)

Basic
Operation

VCR
Operation

DVD
Operation

For Your
Information

DECK & Cassette Information

Head Cleaning

Playing older or damaged tapes may eventually cause video heads to become clogged.

Video Head Clog Sensor

During playback, this screen appears if clogging is detected. To remove screen, press PLAY on the remote or DECK.

VIDEO HEADS MAY
NEED CLEANING
PLEASE INSERT HEAD
CLEANING CASSETTE
OR REFER TO MANUAL
END :PLAY

- Use "dry" type head cleaning cassette only. (Part No. NV-TCL30PT is recommended.)
- Follow cleaning tape instructions carefully. Excessive use of tape can shorten head life.
- If head clog symptoms persist, contact your nearest servicenter by visiting our Web Site (see p. 55).

Prevent Accidental Tape Erasure

Break off the tab to prevent recording.



To record again

Cover the hole with cellophane tape.

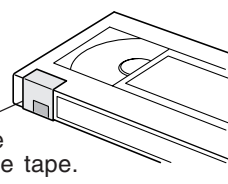

Record/ Playback Time

Only use tapes with the **VHS** mark in this DECK.

Tape Speed Setting	Type of Video Cassette		
	T60	T120	T160
SP (Standard Play)	1 Hour	2 Hours	2 Hours 40 Minutes
LP (Long Play)	2 Hours	4 Hours	5 Hours 20 Minutes
SLP (SuperLong Play)	3 Hours	6 Hours	8 Hours

Cleaning DECK

Use a soft cloth or dusting attachment of a vacuum cleaner to remove dust from the ventilation holes on the back sides and bottom of the cabinet. Plastic surfaces are easily scratched and can be marred by alcohol and various solvents. Avoid excessive use of oil-based furniture polishes since the materials used in the cabinet will accumulate more dust. We recommend using a non-abrasive, antistatic cleaner and polisher.

Features for a Quality Picture (VCR)

Digital Auto Picture

Automatically controls the video output signal for less noise depending on the tape condition.

Digital Auto Tracking

Continuously analyzes the signal and adjusts for optimum picture quality.

Manual Tracking Control (to reduce picture noise)

Use during Playback and Slow Motion mode to reduce picture noise.

Press CH (TRACKING) ▲/▼ on the remote control or on DECK until the picture clears up.

To return to Auto Tracking, press POWER off, then on again a few seconds later.

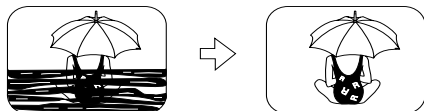

V-Lock Control (to reduce picture jitter)

In Still mode, CH (TRACKING) ▲/▼ operate as a V-Lock control.

6

For assistance, please call : 1-800-211-PANA(7262) or send e-mail to : consumerproducts@panasonic.com

Specifications

Power Source:	120 V AC, 60 Hz
Power Consumption:	<u>Power On:</u> Approx. 32 watts, <u>Power Off:</u> Approx. 4 watts
Video Signal:	EIA Standard NTSC color
Video Recording System:	4 rotary heads helical scanning system
Audio Track:	1 track (Normal), 2 channel (Hi-Fi Audio Sound)
Tuner:	
Broadcast Channels:	VHF 2 ~ 13, UHF 14 ~ 69
CABLE Channels:	Midband A through I (14 ~ 22), Superband J through W (23 ~ 36) Hyperband AA ~ EEE (37 ~ 64), Lowband A-5 ~ A-1 (95 ~ 99) Special CABLE channel 5A (01), Ultraband 65 ~ 94, 100 ~ 125
Input/Output Terminal:	Audio/Video Line Input/Output, RF Input/Output
Input Terminal:	Audio/Video Line Input (Front)
Output Terminal:	S-Video Output (DVD only), Component Video Output (DVD only) Audio Output 2 (L), (R)
Operating Temperature:	5 °C ~ 40 °C (41 °F ~ 104 °F)
Operating Humidity:	10 % ~ 75 %
Weight:	4.9 kg (10.8 lbs).
Dimensions:	430 (W) x 95.5 (H) x 344 (D) mm 16-15/16" (W) x 3-12/16" (H) x 13-9/16" (D) inch
Discs Played	
(1) DVD-Video Disc	5" (12 cm) single-sided single-layer 5" (12 cm) single-sided double-layer 5" (12 cm) double-sided double-layer (one layer per side) 3" (8 cm) single-sided single-layer 3" (8 cm) single-sided double-layer 3" (8 cm) double-sided double-layer (one layer per side)
(2) Compact Disc	5" (12 cm) disc 3" (8 cm) disc
	(CD-DA, Video CD) (CD-R/CD-RW, MP3, WMA, JPEG)
Digital Audio Output:	Digital Optical Connector
Pickup:	Wavelength: 655 nm (DVD), 790 nm (Video CD/CD) Laser power: CLASS II

Note: • Designs and specifications are subject to change without notice.

Definition of Terms (DVD)

Angle:	Some DVD discs feature scenes simultaneously shot from different angles. The ANGLE button can be used to view the scene from different angles. (ANGLE Indicator lights on DECK when a scene recorded at different angles is detected.)
Chapter Number:	Titles are subdivided into numbered sections. You can quickly search for a favorite scene using these numbers.
DVD:	A high-density optical disc on which high-quality pictures and sound have been digitally recorded. DVD incorporates new video compression technology (MPEG II) and high-density recording technology which allow entire movies to be recorded with incredible playback quality.
Playback Control:	With Video CD (version 2.0), scenes or information may be selected for viewing or listening from an interactive menu that appears on the TV screen.
Subtitles:	Written dialogue which appears at the bottom of the screen.
Time Number:	The elapsed play time from the start of a disc or title. Use to quickly find scenes. (May not work with some discs.)
Title Number:	For DVD discs with two or more titles, the title is numbered as title 1, title 2, etc.
Track Number:	Numbers assigned to tracks on Video CDs and CDs to allow specific tracks to be quickly located.
Video CD:	CD containing picture and sound with same quality level as video tape. This DECK also supports Video CDs with playback control (version 2.0).

Apparatus Claims of U.S. Patent Nos. 4,631,603, 4,577,216, 4,819,098 and 4,907,093, licensed for limited viewing uses only.

This product incorporates copyright protection technology that is protected by method claims of certain U.S. Patents and other intellectual property rights owned by Macrovision Corporation and other rights owners. Use of this copyright protection technology must be authorized by Macrovision Corporation, and is intended for home and other limited viewing uses only unless otherwise authorized by Macrovision Corporation. Reverse engineering or disassembly is prohibited.

Location of Controls

Remote Control

Bold: VCR Function
Italic: DVD Function
Bold Italic: VCR and DVD Functions
 Normal: Others

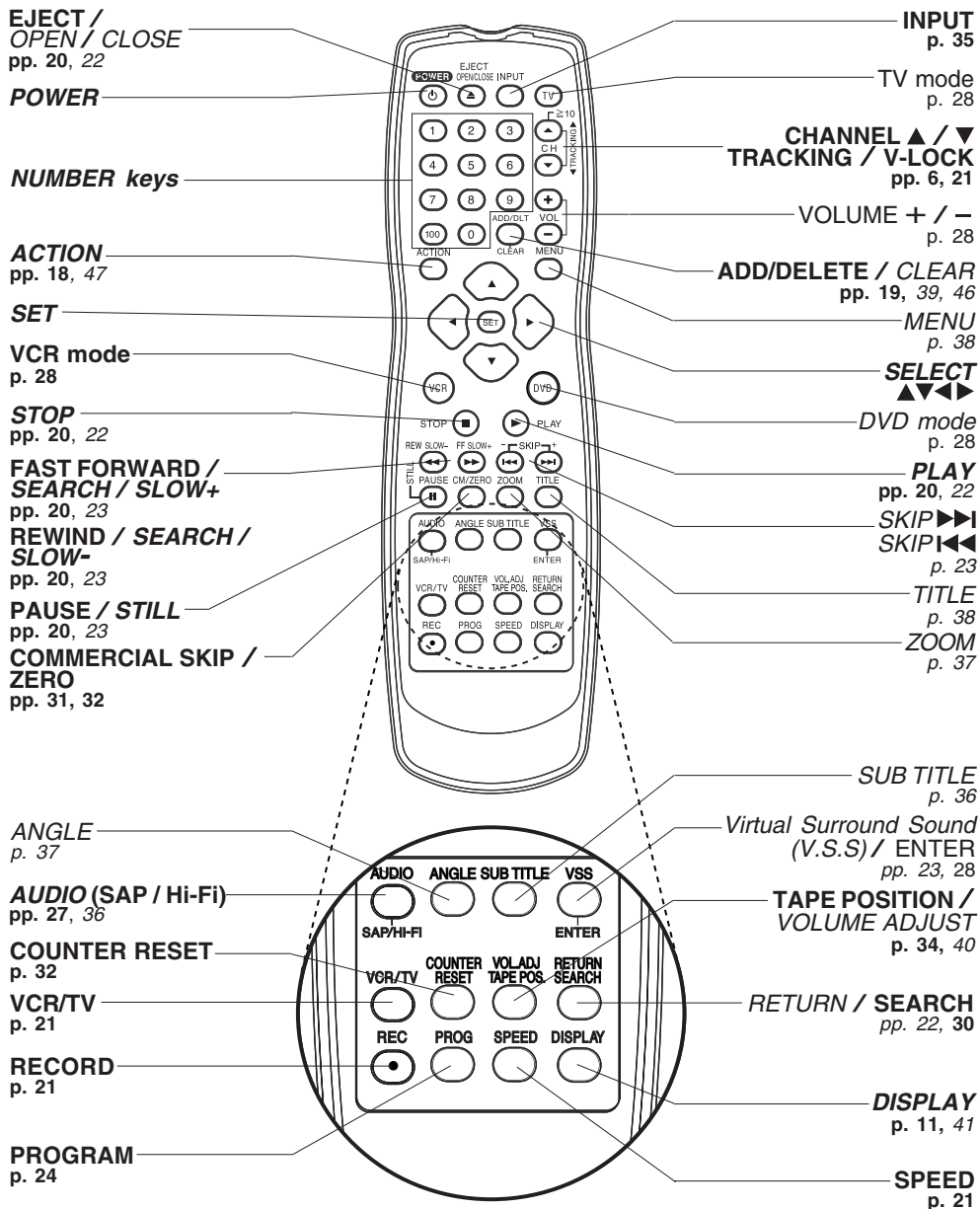

Front View of DECK

Bold: VCR Function
Italic: DVD Function
Bold Italic: VCR and DVD Functions
 Normal: Others

STOP/EJECT
 p. 20

FAST FORWARD/SEARCH
 p. 20

PLAY
 p. 20

REWIND/SEARCH
 p. 20

POWER

**Audio/Video
 Input Connector 2
 (LINE 2)** p. 35

**CHANNEL ▲/▼
 TRACKING/V-LOCK**
 pp. 6, 21

REC
 p. 21

**Cassette
 Compartment**

Disc Tray

OPEN/CLOSE
 p. 22

**Multi Function
 Display**
 p. 11

**Remote
 Sensor**

PROGRESSIVE
 p. 10

PAUSE
 p. 23

**SKIP ►►►
 SKIP ◄◄◄**
 p. 23

PLAY
 p. 22

STOP
 p. 22

If the disc cannot be removed...

First, unplug DECK. Then, prepare a rigid wire (e.g. an extended paper clip) and, applying moderate force, insert it straight into the hole at the base of the tray. The tray will eject a little. Now, pull the tray all the way out and remove the disc.

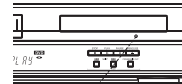

Over 2 inches

Over 2 inches

**Initial Setup
 (Connection)**

Reset All Memory Functions

Use when moving DECK to new location, or if a mistake was made in the Initial Setup section (return to Factory Setting).

- Make sure a tape is not inserted in the DECK.

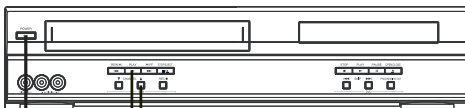

1

2

- 1 Turn DECK Power on.
- 2 Press and hold both **VCR PLAY** and **CHANNEL ▲** on the DECK for more than 5 seconds.
 - The power shuts off.
- 3 Do "Initial Setup (Ready to Play)" on page 16.

9

Location of Controls (continued)

Rear View of DECK

Bold: VCR Function *Italic:* DVD Function
Bold Italic: VCR and DVD Functions

AC Power Plug

- While plugged into an AC outlet, this DECK consumes 4 W of electrical power in off mode.

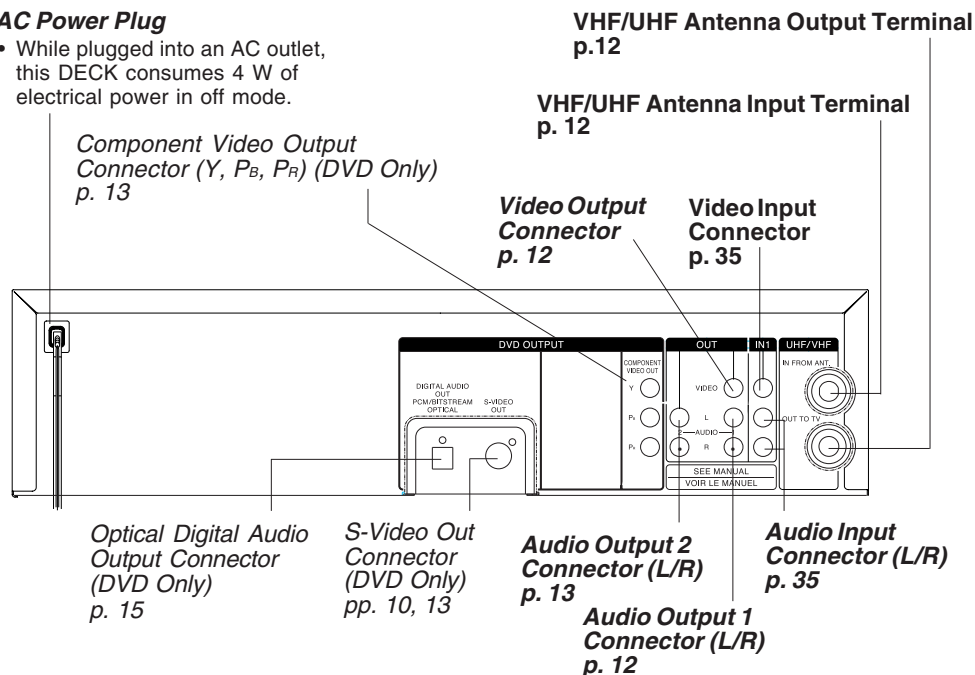

The following table shows the status of the output jacks when in VCR or DVD mode.

	<i>Video Output Audio Out 1 Audio Out 2</i>	<i>Component Video Output</i>	<i>S-VIDEO OUT</i>
VCR	YES	N/A	N/A
DVD	YES	YES	

- Note** • PROG functions on the remote are not available when using Component Video Output and S-VIDEO OUT. Please set TV to either RF INPUT or VIDEO INPUT, and then press PROG.

To enjoy PROGRESSIVE SCAN video

- Connect *Component Video Output* to the component video input terminals of a television. (See p. 13.)
- When the PROGRESSIVE button is pressed, the ON lamp lights up (see p. 9) and the PROGRESSIVE SCAN signal is output from the *Component Video Output Connector*.

Notes

- The PROGRESSIVE button can be operated when the DECK is in DVD function mode.
- The screen may shift off-center when using progressive output. Please adjust the screen position if this occurs. (Refer to your TV manual.)
- The DECK outputs video signals (not PROGRESSIVE SCAN) from the "VIDEO OUT" and "S-VIDEO OUT" terminals when the ON lamp is lit.

Displays (On Screen & Multi Function)

On Screen Displays (VCR)

Function & Channel Displays

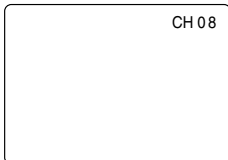

When a function button is pressed, e.g. PLAY, or you change channels, a 5-second display appears.

Blank Tape/ No Video Signal Indications

Whenever a blank section of a tape comes up in Play mode, or when the selected channel has no broadcast signal with Weak Signal Display Feature (p. 33) set to OFF, the TV screen will turn solid blue.

Initial Setup
(Connection)

VCR Status & Clock Displays

To display or remove overlay at right,

→ press DISPLAY.

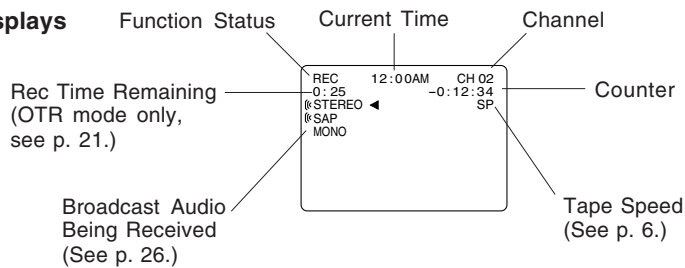

Multi Function Display

VCR mode Indicator

Lights up when DECK is VCR mode.

DVD mode Indicator

Lights up when DECK is DVD mode.

Tape Indicator

Lights up when a tape is inserted.

DISC Indicator

Lights up when a disc is inserted.

Hi-Fi Indicator

Lights up when Hi-Fi audio is monitored in Play mode.

VCR REC Indicator

Lights up during recording.

ANGLE Indicator

Lights up when a scene recorded at different angles is detected. (See p. 37.) (DVD only).

AM/PM Indicator

Timer Indicator

Lights up when DECK is set for Timer Recording, or when One Touch Recording (OTR) is used. Flashes when Timer Recording is set, but a tape has not been inserted into DECK and when a power interruption occurs during Timer Programming.

Clock/ Status/ Channel/ Speed Display

Displays the current time. Briefly displays DECK status when a function button is pressed. Briefly displays the channel number, or "L1" or "L2" when a channel or line input is selected. Briefly displays the recording speed when SPEED is pressed.

Connections

Basic Connections

- If your TV has AUDIO and VIDEO IN terminals, connect them to DECK for higher quality picture and sound.
- You can enjoy stereo sound even if your TV is not stereo by connecting a stereo amplifier to DECK.
- Connect DECK and TV with an RF Coaxial Cable (a) (supplied) or an AV Cable (b) (not supplied) as shown in the figure below.

■ DSS Receiver → DECK → TV ■ DECK → TV ■ Cable Box → DECK → TV

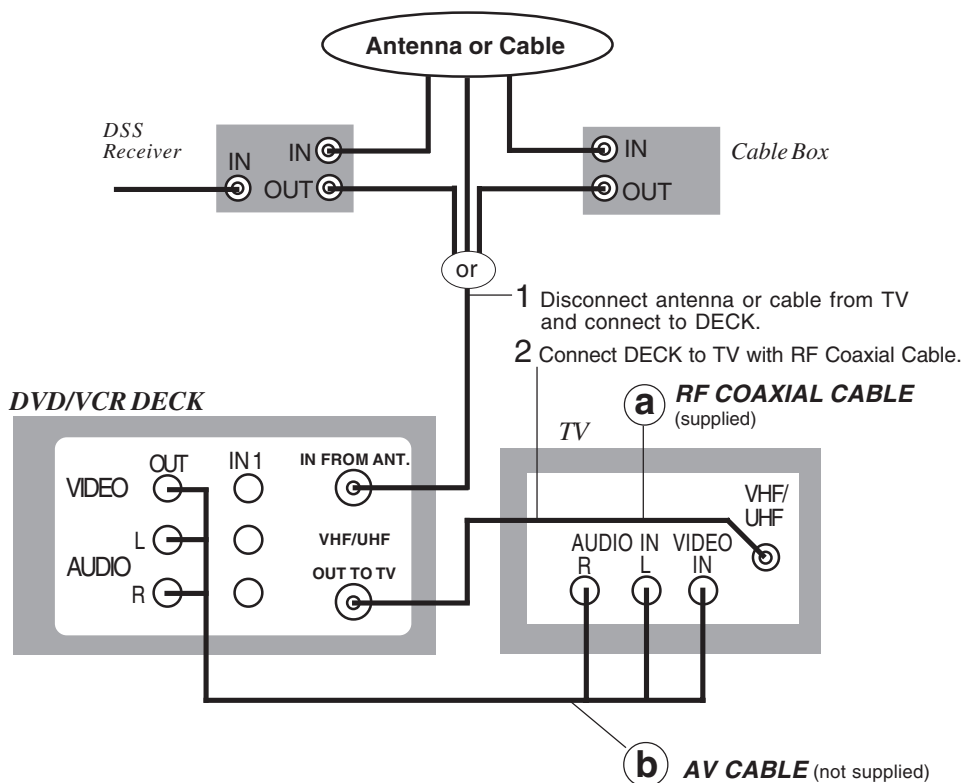

WARNING

When using "Nut type" RF coaxial cables, tighten with fingers only. Overtightening may damage terminals.

Note to CABLE system installer

This reminder is provided to call the CABLE system installer's attention to Article 820-40 of the NEC in USA (and to the Canadian Electrical Code in Canada) that provides guidelines for proper grounding and, in particular, specifies that the cable ground shall be connected to the grounding system of the building, as close to the point of cable entry as practical.

Other Connections

With a Cable Box (DECK → Cable Box → TV)

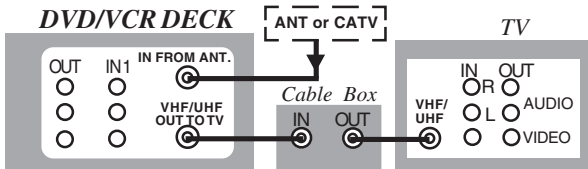

Connect With Two Cable Boxes

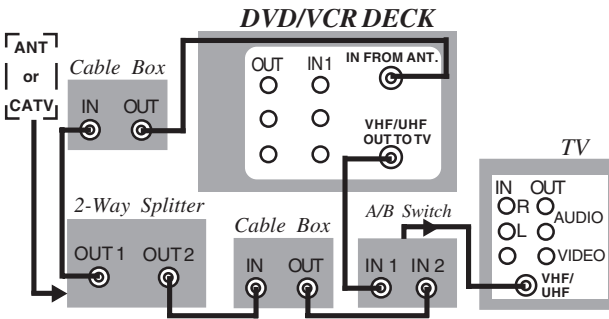

You Can

- view any (including scrambled) channel.
- use Remote Control to select channels without using Multi-brand control feature.

You Cannot

- record scrambled channels.

You Can

- record and view both scrambled and unscrambled channels if additional equipment is added. This connection requires: two converter boxes, an A/B switch, and a 2-way splitter.

You Cannot

- view a channel other than the one selected for any type of recording.
- do a Timer recording of a channel unless you select it on the Cable Box.

Initial Setup
(Connection)

Connections For DVD Only (enjoying higher picture quality)

- Connect AUDIO OUT2 (L, R) to the AUDIO IN (L, R) of the TV. (audio input for COMPONENT or S-VIDEO mode).
- If your TV has COMPONENT VIDEO INPUT, connect to COMPONENT VIDEO OUT. If your TV does not have COMPONENT VIDEO INPUT but has S-VIDEO INPUT, connect to S-VIDEO OUT.
- When in DVD mode, set your TV to either COMPONENT VIDEO IN or S-VIDEO IN.

Notes

- You can watch DVDs through the S-VIDEO or COMPONENT VIDEO, VHF/UHF OUT TO TV, and VIDEO OUT connections to your TV. The VCR and TUNER pictures are available only from the VIDEO OUT and VHF/UHF OUT TO TV connections to your TV.
- PROG functions on the remote are not available when using S-VIDEO OUT and COMPONENT Video Output. Please set TV to either RF INPUT or VIDEO INPUT, and then press PROG.
- TV must have capability to accept and display a progressive scan signal to use PROGRESSIVE mode. Consult your TV operating instructions.

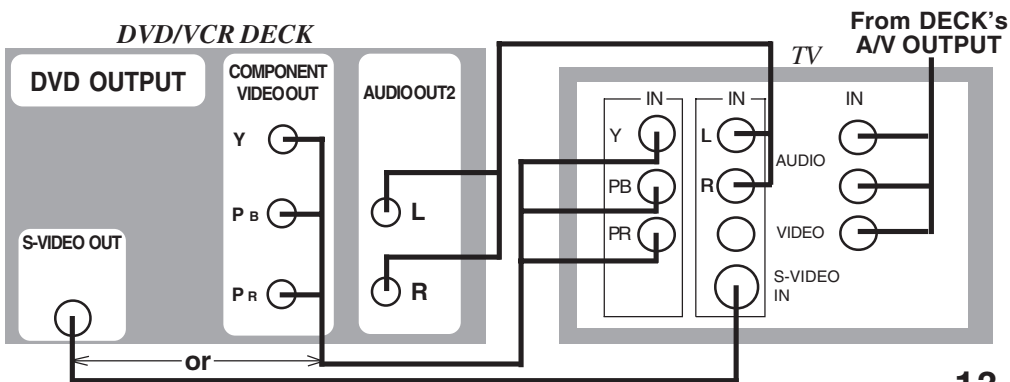

13

Connections (continued)

Audio Connections

✓ Ready Checklist

- Turn down the volume, then turn DECK, as well as other equipment to be connected, off before proceeding with connection.
- Do not block ventilation holes of any of the equipment and arrange them so that air can circulate freely.
- Read through the instructions before connecting other equipment.
- Ensure that you observe the color coding when connecting audio and video cables.

■ Connecting Amplifier (2ch stereo system) [Analog connection]

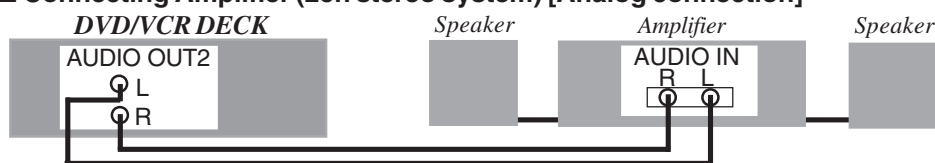

Enjoying digital audio output from the digital audio output connector

Notes on audio output from the optical digital audio output connector

Disc	Sound recording format	Optical digital audio output from connector
DVD	Dolby Digital	Dolby Digital bitstream (1 - 5.1 ch) or PCM (48 kHz sampling/16 bit only)*1
	Linear PCM (48/96 kHz 16/20/24bit)	Linear PCM (2 ch) (48 kHz sampling/16 bit only)*2
	DTS	Bitstream or PCM (48 kHz sampling/16 bit only)*1
Video CD	MPEG 1	PCM (44.1 kHz sampling)
CD	Linear PCM	Linear PCM (44.1 kHz sampling)
MP3	MP3	Linear PCM (It depends on the MP3 file)
WMA	WMA	Linear PCM (It depends on the WMA file)

*1 The type of audio output from the connector can be selected by the Settings for DVD Operation. (See p. 48.)

*2 Sound having 96 kHz sampling is converted into 48 kHz sampling when it is output from the DECK's optical digital audio output connector.

For your reference:

- Dolby Digital is a digital sound compression technique developed by the Dolby Laboratories Licensing Corporation. Supporting 5.1-channel surround sound, as well as stereo (2-channel) sound, this technique enables a large quantity of sound data to be efficiently recorded on a disc.
- Linear PCM is a signal recording format used in CDs. While CDs are recorded in 44.1 kHz/16 bit, DVDs are recorded in 48 kHz/16 bit up to 96 kHz/24 bit.
- If you have a Dolby Pro Logic Surround decoder, you will obtain the full benefit of Pro Logic from the same DVD movies that provide full 5.1 channel Dolby Digital soundtracks, as well as from titles with the Dolby Surround mark. For information on Panasonic or Technics Dolby Pro Logic Surround Sound Decoders please contact your local dealer.

Manufactured under license from Digital Theater Systems, Inc. US Pat. No. 5,451,942, 5,956,674, 5,974,380, 5,978,762 and other world-wide patents issued and pending. "DTS" is a registered trademark of Digital Theater Systems, Inc. Copyright 1996, 2000 Digital Theater Systems, Inc. All rights reserved.

Manufactured under license from Dolby Laboratories.
"Dolby" and the double-D symbol are trademarks of Dolby Laboratories.

■ **Connecting Amplifier (5.1 ch Surround system) [Digital connection]**
DECK → Dolby Digital Decoder → Amplifier → Speaker

or

DECK → DTS (digital theater systems) Decoder → Amplifier → Speaker

When DVDs recorded in Dolby Digital or DTS are played, Dolby Digital bitstream or DTS bitstream is output from the DECK OPTICAL digital audio output connector. When DECK is connected to a Dolby Digital decoder or DTS decoder, you can enjoy theater-quality audio in your home. [An optical digital audio cable (optional) is required when an optional Dolby Digital decoder or DTS decoder is used.]

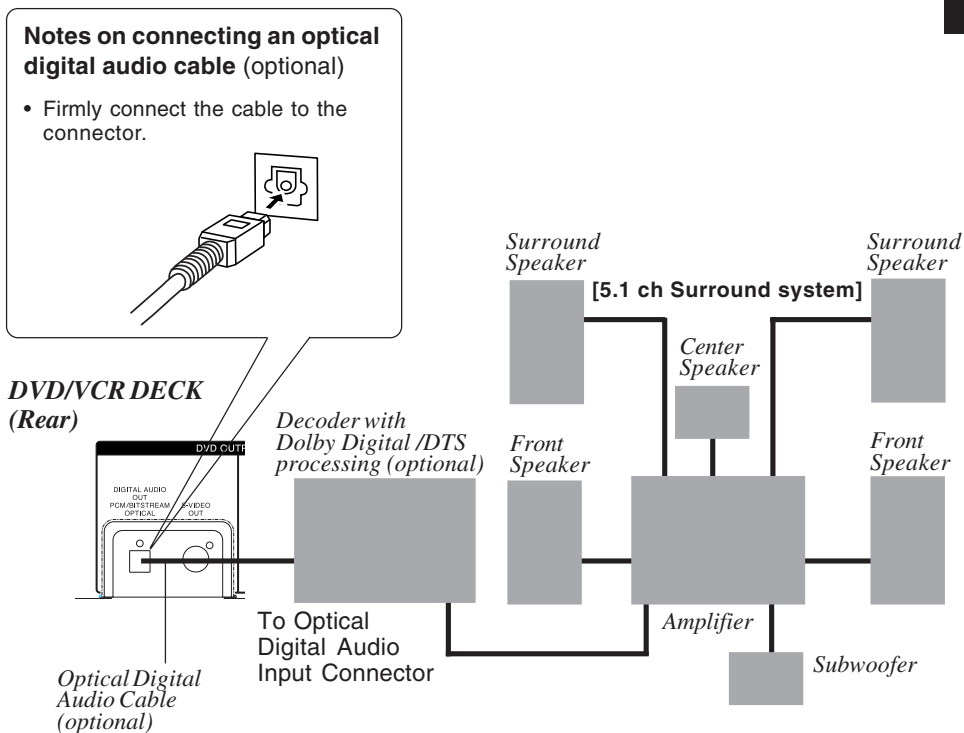

Caution for optical digital audio output connector:

- When connecting an amplifier (with an Optical Digital Input Connector) which does not contain the Dolby Digital or DTS decoder, be sure to select “PCM” at “Dolby Digital” and “PCM” at “dts” of the Settings for DVD Operation “Audio Output” (see p. 48). Otherwise, any attempt to play DVDs may cause such a high level of noise that it may be harmful to your ears and damage your speakers.
- When a Dolby Digital/DTS decoder is connected, please select “Bitstream” at “dts” or “Dolby Digital” of the Settings for DVD Operation “Audio Output”. If “PCM” is selected, there will be stereo sound. (See p. 48.)
- Video CDs and CDs can be played as usual.

Note:

- Some DTS decoders which do not support DVD-DTS interface may not work properly with DECK.

Initial Setup for Basic Connections (Ready to Play)

Before doing Initial Setup

- 1 Turn TV on.
- 2 See connections (a) RF Coaxial Cable Connection and (b) AV Cable Connection on page 12.
<RF Coaxial Cable Connection>
Set TV to **channel 3**.
<AV Cable Connection>
Set TV to **VIDEO**.
- 3 [DECK → TV]
 - Go to “Initial Setup (Ready to Play).” (See below.)[Cable Box → DECK → TV], [DSS → DECK → TV]
 - Turn on Cable Box and set it to your Public Broadcasting Station (PBS) channel in your time zone.
 - If you use a DSS Receiver, it must be turned off.

Initial Setup (Ready to Play)

- 1 Press VCR on remote for VCR mode.
- 2 Plug DECK Power Cord into AC wall outlet. DECK comes on and auto channel and clock set starts.
 - If screen below does not appear, check DECK - TV connection and, if TV is tuned to channel 3, try switching it to channel 4.
 - To change VCR's output channel, please refer to “VCR's Output Channel” on page 19.

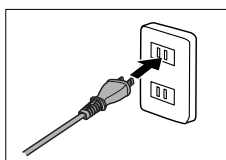

Plugging the AC Power Plug into an AC outlet

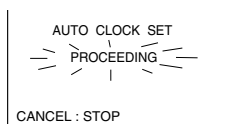
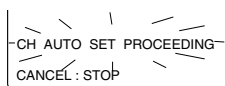

Notes

- Function buttons are inoperative during Initial Setup.
- To remove a cassette during Auto Set, press EJECT on the remote or STOP/EJECT twice on the DECK. In this case, settings must be made manually. (See p. 18.)
- Depending on conditions, Auto Clock Set may take longer than 30 minutes. If so, press STOP to stop setup and perform settings manually. (See p. 18.)

Continued on next page...

***Important:** If a remote control button does not work when pressed, press the VCR button on the remote and try the button again.

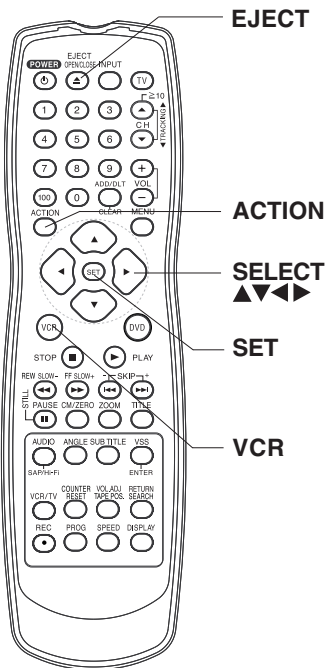

3 Settings are made automatically. When setup is done, this screen appears.

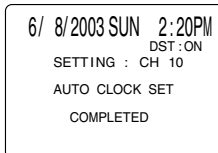

If "AUTO CLOCK SET IS INCOMPLETE" appears, manually set clock. See below.

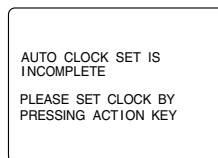

Initial Setup (Connection)

Manual Clock Set

If Auto Clock Set was incomplete.

1 Press ACTION* on remote to display CLOCK screen.

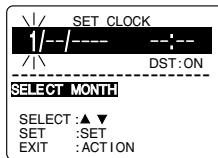

2 Press ▲▼ to select the month and SET to set. In the same manner, select and set the date, year, time, and DST (Daylight Saving Time).

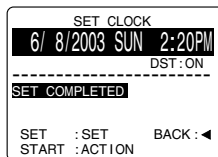

3 Press ACTION to start clock and exit.

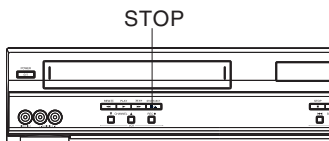

Reset Language, Channels, Clock, VCR's

VCR's

1

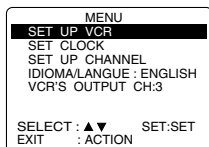

Press **ACTION*** to display MENU.

- PROGRAM functions are not available when using COMPONENT Video Output and S-VIDEO OUT. Please set TV to either RF INPUT or VIDEO INPUT, and then press PROGRAM.

2

Language

- 1) Press **▲▼** to select language item.

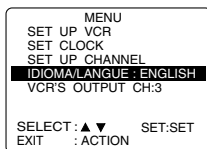

- 2) Press **SET** repeatedly to change language item as shown below.

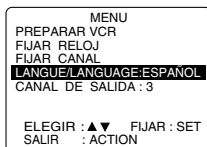

For Spanish ↓



For French ↓

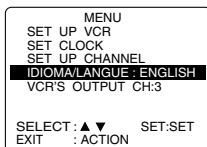

For English

- 3) Press **ACTION** to exit.

Channels

- 1) Press **▲▼** to select "SET UP CHANNEL," and press **SET**.

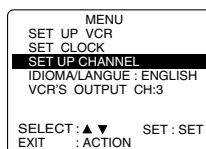

- 2) Press **▲▼** to select "ANTENNA," then press **SET** to set your antenna system ("TV" or "CABLE.")

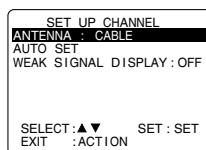

- 3) Press **▲▼** to select "AUTO SET," then press **SET**.

- If you use a Cable Box, set it to the PBS channel in your time zone.

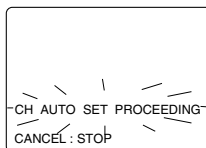

- After Channel Auto Set is finished, Auto Clock Set will be performed.

Clock

- 1) Press **▲▼** to select "SET CLOCK," and press **SET**.

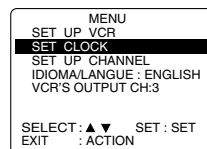

- 2) Press **▲▼** to select "MANUAL," and press **SET**. (For Auto Clock Set, select "AUTO CLOCK SET.")

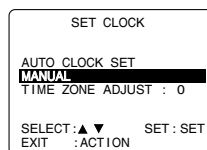

("TIME ZONE ADJUST" appears only when auto clock is set.)

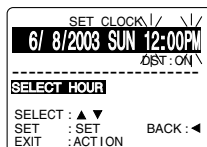

- 3) Press **▲▼** and **◀** to select, then set the date, time, and DST (Daylight Saving Time).

- 4) Press **ACTION** to start Clock and exit this mode.

VCR's Output Channel

***Important:** If a remote control button does not work when pressed, press the VCR button on the remote and try the button again.

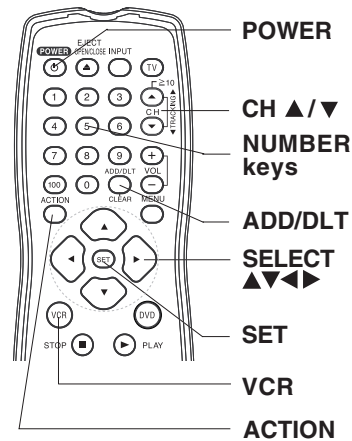

Basic
Operation

Time Zone Adjust

(Only when Auto Clock is set.)

- 1) Press **▲▼** to select "SET CLOCK," and press **SET**.

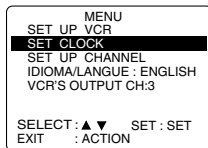

- 2) Press **▲▼** to select "TIME ZONE ADJUST,"

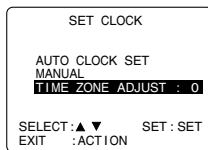

and press **SET** to subtract or add hour(s) as necessary.

- 3) Press **ACTION** twice.
 - "TIME ZONE ADJUST" returns to "0" if clock is set manually.

VCR's Output Channel

- 1) Press **▲▼** to select "VCR'S OUTPUT CH.," and press **SET**.

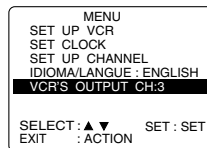

- 2) Press **SET**.

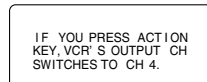

- 3) Press **ACTION**.

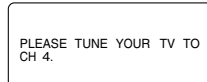

↓ After 3 seconds

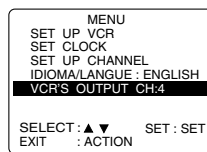

- To Make Corrections, repeat steps 1) ~ 3).

Add or Delete a Channel

To add channel:
Select channel with **NUMBER** keys and press **ADD/DLT**.

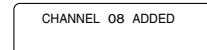

To delete channel:
Select channel with **CH ▲▼** or **NUMBER** keys and press **ADD/DLT**.

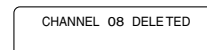

DST (Daylight Saving Time)

DECK auto adjusts clock for DST. (p. 17.)

Spring (First Sunday in April)
DST:ON → Sets clock ahead one hour.

Autumn (Last Sunday in October)
DST:ON → Turns clock back one hour.

- If your area does not observe Daylight Saving Time, select DST:OFF.
- Keep these time changes in mind when programming DECK for timer recordings.

Playback/ Record on a Tape

✓ Ready Checklist

- All connections are made. (pp. 12 ~ 15)
- TV and DECK are plugged in.
- TV is on and tuned to CH 3, 4, or VIDEO.
- Remote is in VCR mode. (Press VCR.)

Playback a Tape

1 Insert a tape.

- DECK power comes on. If Auto VCR/TV (see p. 32) is set to "OFF," press VCR/TV on the remote to be VCR mode.

2 Press **PLAY*** to play a tape.

- If tape has no rec. tab (p. 6), auto play begins.

Special Features During Play

■ Forward/Reverse Scene Search

- Press **FF/SLOW+** or **REW/SLOW-**.
- Press **PLAY** to release.

After search has begun, each additional press of **FF** or **REW** changes speed as shown below.

[SLP] : Approx. 21X ↔ Approx. 9X

[LP] : Approx. 9X ↔ Approx. 7X

[SP] : Approx. 7X ↔ Approx. 3X

If at 21X, 9X, or 7X speed the picture is interrupted, change speed to 9X, 7X, or 3X.

Notes

- Picture interruption may occur with some TVs.
- FF and REW search speed may vary depending on current tape position.

■ Still (Freeze) Picture

- Press **PAUSE/STILL**.
- Press **PLAY** to release.

■ Frame by Frame Picture

- Press **PAUSE/STILL** in Still mode.
- Press **PLAY** to release.

■ Slow Motion Picture

- Press **FF/SLOW+** (increase speed) or **REW/SLOW-** (decrease speed) in Still mode.
- Press **PLAY** to release.

3 Press **STOP** to stop a tape.

- Press **REW/SLOW-** or **FF/SLOW+** in Stop mode to rewind or fast forward a tape.

- Press **EJECT** on remote, or **STOP/EJECT** on DECK to eject a tape.

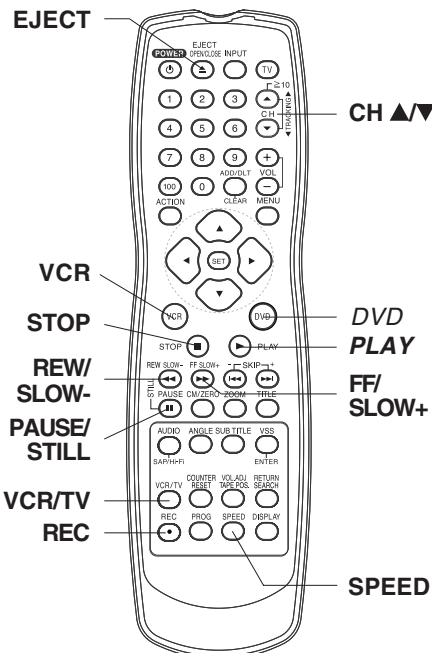

Notes

- These features work best in SP or SLP mode.
- The sound will be muted.
- To reduce picture noise, see "Manual Tracking Control" on page 6.
- After DECK is in Still or Slow mode for 3 minutes, it will switch to Stop mode automatically to protect the tape and the video head.

Playback using DECK buttons

- 2 Press **PLAY**.
- 1 Insert a tape.



Multi Function Display

- Press **STOP/EJECT** to stop and/ or eject a tape.

***Important:** If a remote control button does not work when pressed, press the VCR button on the remote and try the button again.

Record on a Tape

- 1 Insert a tape with a record tab** (p. 6).
 - DECK power comes on. If Auto VCR/TV (see p. 32) is set to "OFF," press VCR/TV on the remote to be VCR mode.
- 2 Press CH ▲▼, or NUMBER keys** to select the channel.
 - For "LINE" input, see page 35.
 - If channel is over 100, press 100 key then press the remaining 2 digits.
- 3 Press SPEED** to select the record speed (p. 6).
 - SP = Standard Play LP = Long Play
 - SLP = Super Long Play
 - Speed appears on-screen and on Multi Function Display.
- 4 Press REC** to start recording.
 - (The VCR REC indicator lights up on Multi Function Display),
 - To edit out unwanted scenes, **press PAUSE/STILL** to pause, and again to resume recording.
 - You cannot view another channel during recording.
- 5 Press STOP** to stop recording.

This video recorder, equipped with HQ (High Quality) system, is compatible with existing VHS equipment. Only use tapes with the **VHS** mark. Only tapes tested and inspected for use in 2, 4, 6, and 8 hour machines are recommended.

Note
Remove loose or peeling labels from tapes to prevent tape jam.

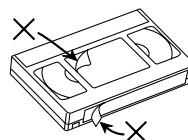

Basic Operation

- **One Touch Recording** (recording in progress),
 - **press REC** repeatedly to set the recording length (30 min. ~ 4 hours).
 - DECK shuts off after the preset record length.
- **Record one station, watch another,**
 - **press VCR/TV** on the remote (change to TV mode),
 - select channels at TV (recording continues).
- **Select Channels at DECK** (In STOP or REC. PAUSE mode),
 - **press VCR/TV** on the remote (change to TV mode),
 - select channels at DECK.
- **Play a disc while recording a tape.**
 - insert a disc during recording,
 - **press DVD**, and then **press PLAY**.

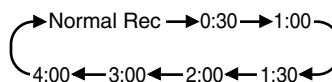

Notes

- **It is not possible to record from DVD/ Video CD/ CD to VHS tape using DECK.**
- **Watching one channel and recording another is not possible when using Cable Box or DSS Receiver.**
- After 5 minutes in Pause mode, DECK stops to protect a tape and video heads.

Record using DECK buttons

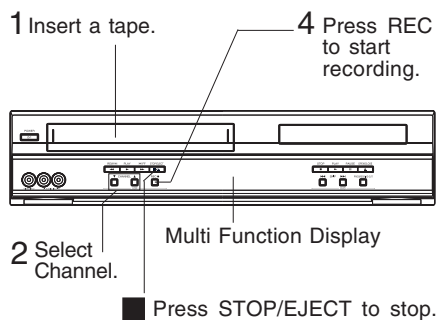

Basic DVD Operation

✓ Ready Checklist

- All connections are made. (pp. 12 ~ 15)
- DECK is plugged in.
- If DECK is connected to an audio amplifier, turn the stereo system's power on.

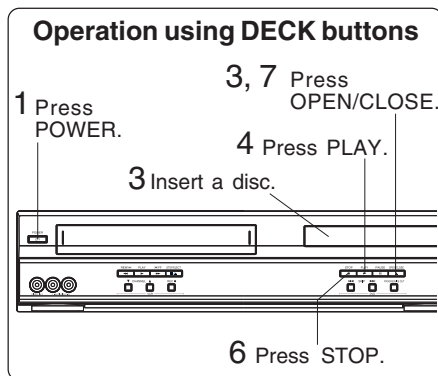
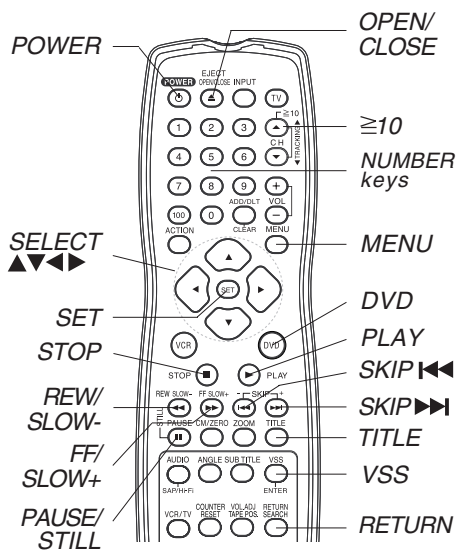

- *1 Interactive DVD...
May include multiple camera angles, stories, etc.
- *2 Video CD with playback control...
Particular scenes or information can be interactively selected from a menu that appears on the screen.

1 Press **POWER*** on the remote or DECK.

2 Press **DVD** to select DVD mode.
• If a disc is already inserted, go to step 4. (Depending on the disc, playback may start automatically.)

3 Press **OPEN/CLOSE**, and then place a disc into the disc tray.

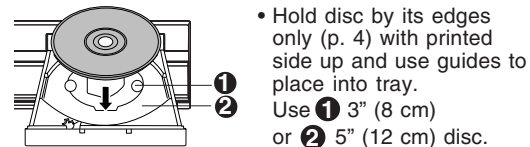

- Hold disc by its edges only (p. 4) with printed side up and use guides to place into tray.
- Use **1** 3" (8 cm) or **2** 5" (12 cm) disc.

4 Press **PLAY** to start playing. Disc tray closes automatically.

- You may also close tray by pressing **OPEN/CLOSE**.
- Data reading time differs with each disc.

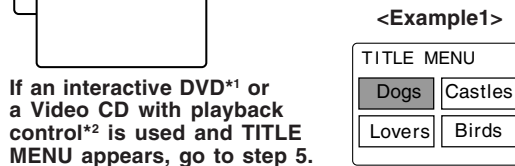

If an interactive DVD*1 or a Video CD with playback control*2 is used and **TITLE MENU** appears, go to step 5.

5 Press **▲▼◀▶** or **NUMBER keys** (see below) to select title, and press **SET** or **PLAY** to start playing.
• "Pressing **SET** or **PLAY**" is not necessary when using **NUMBER keys**.

Using NUMBER keys starts playing automatically.
The number of available titles varies with each disc.
<Input> 1 digit number 1 ... 1
<Example> 2 digit number 12 ... ≥ 10 1 2
3 digit number 123 ... 100 1 2 3

Press **SKIP ▶▶** or **◀◀** to go to next or previous menu screen.
• SKIP function not available with all discs. Please refer to disc jacket for operation information.
To return to menu (play stops)
Press **TITLE**, **MENU**, or **RETURN**. (DVD)
Press **RETURN**. (Video CD)

6 Press **STOP** to stop playing.

7 Press **OPEN/CLOSE** to eject the disc.

***Important:** If a remote control button does not work when pressed, press the DVD button on the remote and try the button again.

■ Forward/Reverse Scene Search

Press **FF/SLOW+** or **REW/SLOW-** during play.

Press **PLAY** to release.

- Starting forward/reverse search during play started from menu on Video CDs may recall menu.
- Search speed, slow at first, increases with each additional press of the button up to 5 levels.

■ Forward/Reverse Chapter/Track Skip

Press **SKIP ►►** or **◄◄ SKIP** during play. Each press skips a chapter (DVD) or track (Video CD/CD).

- Pressing **◄◄ SKIP** once midway through a chapter/track returns to the start of that chapter/track. Each additional press skips back one chapter/track.
- Pressing **SKIP ►►** or **◄◄** during play started from menu on Video CDs may recall menu.

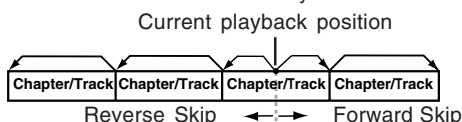

■ Still Picture or Pause

Press **PAUSE/STILL** during play.

Press **PLAY** to release.

- **DVD/Video CD** : DECK will enter still picture mode.
- **CD** : DECK will enter pause mode.

■ Frame by Frame Picture

(DVD/Video CD)

Press **PAUSE/STILL** in still mode.

Press **PLAY** to release.

- Each press advances picture one frame.
- Hold button down for consecutive frame advance.
- Whether pictures are advanced by "FRAME" or "FIELD" is selected automatically. (See p. 49.)

■ Slow Motion Picture (DVD/Video CD)

Press **FF/SLOW+** or **REW/SLOW-** in still mode.

Press **PLAY** to release.

- Slow motion speed, slow at first, is increased with each additional press of the button up to 5 levels.
- Reverse slow motion is not available for Video CDs.

Auto-Power Off Function

Power turns off after DECK has been in Stop mode (DVD) for about 5 minutes.

- When  appears on the screen while a button is being operated, it means that the corresponding operation is prohibited by DECK or the disc.

V.S.S. (Virtual Surround Sound)

Enjoy a surround-like effect if you are using two front speakers only. The effect is broadened and sound seems to come from virtual speakers on either side if the disc has surround signals recorded on it.

Press **VSS** in DVD mode.

- The Surround sound effects can be changed by pressing **VSS** repeatedly as shown by the figure below.



Note

- Surround sound effects is available in DVD mode only.
- Turn off the surround effects on the other equipment.
- V.S.S. will not work, or will have less effect, with some discs.
- Turn V.S.S. off if it causes distortion.
- Sound will only come from the two front speakers if V.S.S. is on.

Basic
Operation

Resume Function

DECK memorizes the point where **STOP** is pressed (**STOP ►** is displayed on screen).

Press **PLAY** to resume play from this point. Pressing **STOP** again or opening the tray cancels **RESUME**, however, **RESUME** is not canceled when power is turned off and on.

- **RESUME** works only with discs for which elapsed play time is displayed during play.

Enjoy Video CDs featuring playback control without using menus (Video CDs only)

1. Do steps 1-4 (previous page). When menu appears, **press STOP**.
2. Press **NUMBER keys** to select desired track (play begins).
 - Check disc for track numbers.
 - Press "1" to start at beginning of disc.

To Resume Menu use,

Press **STOP** and **press PLAY**, then the menu will be displayed.

Now, go to step 5 (previous page).

Notes

- Please read the disc jacket for operation information.
- If a single sided disc is placed in upside down, "THIS TYPE OF DISC CANNOT BE PLAYED. PLEASE INSERT A DIFFERENT DISC" is displayed.
- Remove disc and press **DECK POWER** off when not in use.
- Disc continues to rotate with menu displayed even after play is done. Press **STOP** to clear menu display when finished with menu.

Timer Recording

✓ Ready Checklist

- All connections are made. (pp. 12 ~ 15)
- TV and DECK are plugged in.
- Clock set correctly. (p. 18)
- Tape has rec.tab. (p. 6)
- Remote is in VCR mode. (Press VCR.)
- Sufficient tape remaining for recording time.

1 Press **PROG*** to display Program.

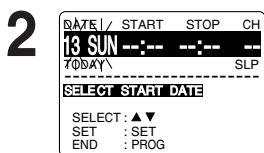

Example Today

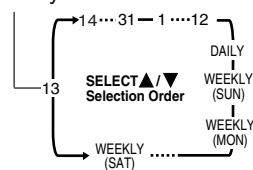

1) To set record DATE, press ▲▼ to select: 1~31= one time, or DAILY= MON~ FRI, or WEEKLY= same time each week and press SET.

• See selection order left.

2) To set remaining items, press ▲▼ to select and press SET to set START/ STOP times, CH (channel) or LINE input (p. 35), and tape speed (SP, LP, SLP).

Press **PROG** to end programming.

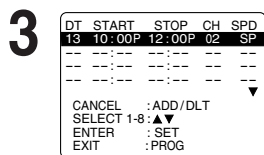

To Enter More Programs, press ▲▼ to select and press SET to set an unused program number, and then repeat step 2.

Or
Press **PROG** to exit.

- The "Timer" Indicator lights up on DECK.
- You can do Timer Recording with the power on or off.
- "TIMER REC WILL START SOON" appears on-screen for 2 minutes before Timer Recording starts. If DECK is in DVD mode, no message appears, but the VCR REC Indicator, the VCR mode indicator and "REC" will flash on Multi function Display.

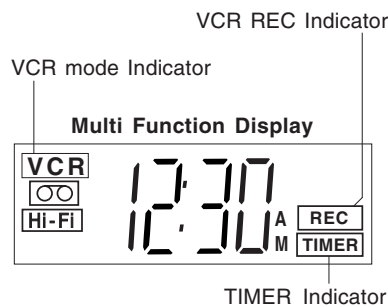
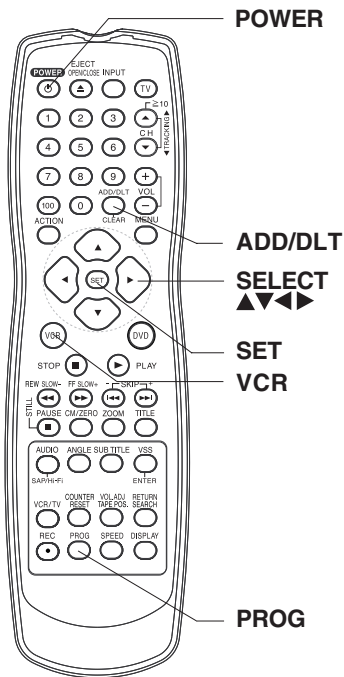

***Important:** If a remote control button does not work when pressed, press the VCR button on the remote and try the button again.

Review, Replace or Clear Program Contents:

(Recording is not in progress)

1 Press **PROG**
to display Program List.

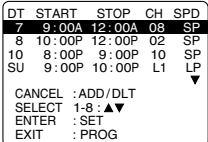
2  Press **▲▼**
to select number and
press **SET**
to display.

To cancel a Timer Recording in progress...

Hold down **STOP** in VCR mode for a few seconds to cancel the Timer Recording.

(The "TIMER" Indicator goes out on Multi Function Display.)

- Any future daily or weekly recording will be performed as programmed.

3 To Replace program...

 Repeat Step 2 (p. 24)
to set new programs.

or

To Clear program...

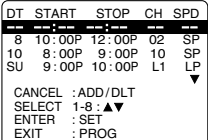
 Press **ADD/HLT**.

4 Press **PROG**
to end the programming.

Notes

- If you are using a Cable Box, the VCR's channel for Timer Recording must be set to the Cable Box input channel and Cable Box must be manually set to the desired channel. Cable Box power must be left on.
- 2 minutes before Timer Recording is performed, "PLEASE PREPARE FOR TIMER REC" appears and Timer Indicator flashes.
Be sure a cassette with record tab is loaded and DECK is in Stop mode.
- If a power interruption occurs while programming the timer, the timer program(s) may be canceled. If "TIMER PROGRAMS WERE LOST DUE TO POWER INTERRUPTION" appears on-screen, please re-enter the timer programs.
- If the start time for Timer Recording comes up during recording and playing back, Timer Recording will not be performed.

Important notes when using DSS Receiver

- When recording programs via DSS Receiver, DSS Receiver must be left on.
- When recording programs via an antenna or cable, DSS Receiver must be turned off.

VCR
Operation

MTS Broadcast/ VHS Hi-Fi Stereo System

Connection

Make the Audio/Video Connection as shown on pp. 12 ~ 15.

- You can use TV connected to a Stereo amplifier and speakers instead of Stereo TV.

Receivable Broadcast Types

The following are possible audio broadcast types and on-screen displays.

The signal being received is indicated with an "Ⓒ" mark while the selected audio mode is indicated with an arrow.

To display the broadcast signal being received,

→ press **DISPLAY***.

MTS Stereo and SAP broadcast

Multi-channel Television Sound Stereo (main language) and Secondary Audio Program (sub language) broadcasts are being received simultaneously. Select STEREO or SAP audio mode.

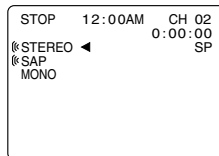

MTS Stereo broadcast

Multi-channel Television Sound Stereo broadcast. Select STEREO audio mode.

- If stereo broadcast is weak and display flickers, select MONO audio mode for possible better results.

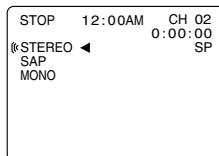

SAP broadcast

Secondary Audio Program (sub language) broadcast. Select SAP audio mode for the sub language.

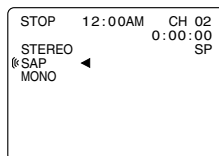

MONO broadcast

Normal monaural sound broadcast.

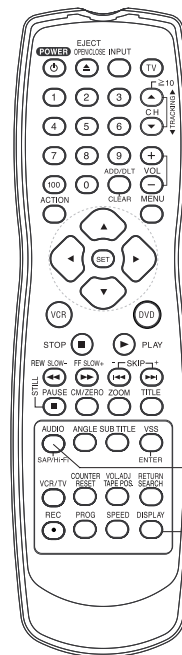
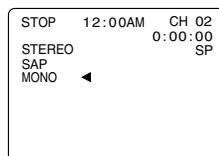

AUDIO (SAP/Hi-Fi)
DISPLAY

Equipped with **dbx**[®]-TV Noise Reduction for true MTS reproduction. **dbx**[®]-TV Noise Reduction is required for good stereo separation and audio fidelity. **dbx**[®] is a registered trademark, and is licensed by **dbx**[®] Technology Licensing.

***Important:** If a remote control button does not work when pressed, press the VCR button on the remote and try the button again.

Audio Mode for Recording

1 Press AUDIO (SAP/Hi-Fi)

to display audio mode.

(Display disappears after 5 seconds.)

2

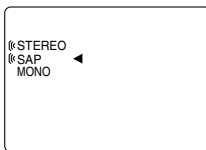

Press AUDIO (SAP/Hi-Fi) repeatedly to select desired mode.

- Refer to “Receivable Broadcast Types” on p. 26.
- Arrow indicates selection.

3 Make a recording.

See p. 21.

Audio Mode for Playback

1 Start playback.

See p. 20.

2 Press AUDIO (SAP/Hi-Fi)

to display audio mode.

3

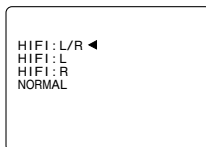

Press AUDIO (SAP/Hi-Fi) repeatedly to select desired mode.

- Select “HI-FI (L/R)” or “HI-FI (L)” or “HI-FI (R)” to listen to stereo recordings in stereo sound. Select “NORMAL” for monaural sound.
- Display disappears after 5 seconds.
- Arrow indicates selection.

Notes

- Only tapes recorded in Hi-Fi stereo will playback with true stereo sound. Standard stereo tapes will playback in monaural sound.
- To listen to Hi-Fi stereo playback, the DECK AUDIO (L/R) jacks must be connected to a stereo TV or an external stereo amplifier and speakers. (See pp. 12, 14.)
- If tracking is adjusted during playback, Hi-Fi audio may revert to normal audio.
- Hi-Fi and normal audio playback volume level may differ.

Multi-Brand Control Feature

Multi-Brand Control Setup

The Remote Control can be set to control some TV functions.

- 1** Find your TV Brand Code Number on the following page.
- 2** Set up for TV control,
 - hold down TV button,
 - enter code with NUMBER keys.
 - If code number is 100 or greater,
 - e.g., press 1 - 0 - 2 for 102.
- 3** Confirm code entry,
 - press POWER to turn selected unit on or off.
 - See table below for controllable functions in each mode.

Notes

- Repeat setup after remote battery replacement.
- Remote will not control every TV made by the manufacturer listed. If you get no response, your particular unit cannot be controlled. There are NO additional codes for the products listed. If your product is not listed, then the remote is not compatible with that product.

Using Multi-Brand Control

After remote is set up, you can select VCR, DVD, or TV for the desired function.

Press **VCR**, **DVD**, or **TV** on the remote.
(Table below shows available remote buttons for each mode.)

Unit Mode	DVD/VCR	TV
DVD/VCR	All	VOL +/-
TV	EJECT/OPEN/CLOSE* , DISPLAY , PLAY , STOP , FF/SLOW+ , REW/SLOW- , VCR/TV , PAUSE/STILL , SKIP , AUDIO , CM/ZERO , TAPE POSITION , COUNTER RESET , SPEED , REC	POWER, INPUT, NUMBER keys, ENTER, CH ▲/▼, VOL +/-

* **Bold:** VCR Function **Bold Italic:** VCR and DVD Functions
Italic: DVD Function Normal: TV

Notes

- Not all functions listed may be controllable.
- In TV mode, it may be necessary to press ENTER after pressing NUMBER keys for channel selection.

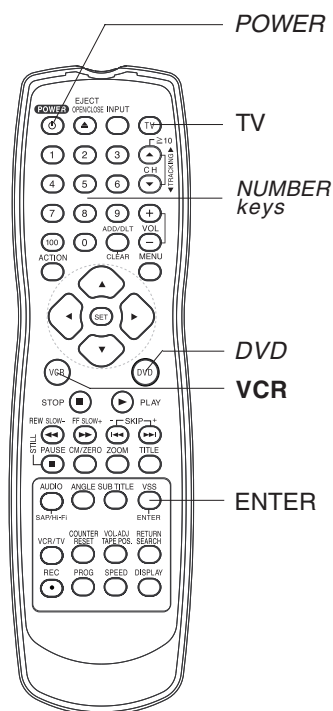

TV Brand Code Numbers

Panasonic	01, 02	Sylvania	05	JVC	11
Quasar	01, 02	Sharp	06, 07	Hitachi	12
RCA	03	Sony	08	Mitsubishi	07, 13
GE	03	Toshiba	09	Samsung	14
Zenith	04	Sanyo	10	Gold Star	15, 16, 17
Magnavox	05	Fisher	10		

Important Notes

- Some manufacturers use several codes for one brand. If the first code entered fails, try the next one listed.
- Some TV brands require you to turn on the power manually.

Tape Operation

Search System

For each recording, an invisible index mark is placed on the tape. A program index and information are also included for timer recordings. These marks are used to access or scan recordings.

Index Search

1

```

INDEX SEARCH
ENTER INDEX NUMBER :1
USING 1- 9 KEYS
FORWARD SEARCH :FF
REVERSE SEARCH :REW
NEXT :SEARCH
EXIT :STOP
    
```

Press **SEARCH*** to display SEARCH in Stop or Play mode, and then press **NUMBER** keys

to select recording number.

- To calculate number, see below.

Press **FF/SLOW+** or **REW/SLOW-** on the remote to start search.

2

```

INDEX SEARCH
FORWARD SEARCH : FF
REVERSE SEARCH : REW
    
```

Play begins at search end. To search forward or back 1 index, press **FF/SLOW+** or **REW/SLOW-** on the remote while screen left is displayed (10 sec.).

- To cancel, press **PLAY** or **STOP**.

To Calculate Index Number

Example 1:

To go to rec. 2 from rec. 4, enter 3 and press REW.

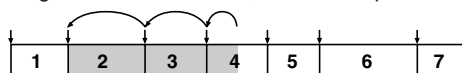

Example 2:

To go to rec. 6 from rec. 2, enter 4 and press FF.

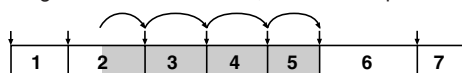

NOTE: ↓ indicates start points of each recording.

Note

- If Index Search is started very close to an index mark, that index mark may not be counted in the search.

Program End Search

Locates end point of recording for continuity.

1

Press **SEARCH** twice to display SEARCH in Stop or Play mode.

2

```

PROGRAM END SEARCH
SEARCH START : FF
EXIT :SEARCH
    
```

Press **FF/SLOW+** on the remote to start PROGRAM END SEARCH.

- To cancel, press **PLAY** or **STOP**.

Examples of Program End Search.

Fig. 1

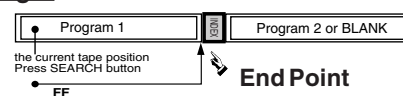

Fig. 2

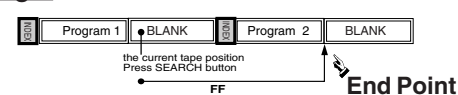
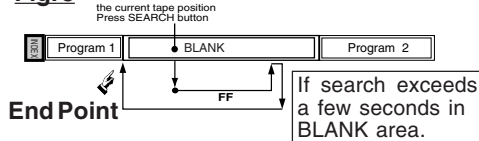

Fig. 3



Upon locating end point,

- search continues 7 sec. past end point,
- tape rewinds to 10 sec. before end point,
- tape plays to end point and stops.

Note

- If Program End Search is started very close to an index mark, that mark may be skipped over.

30

For assistance, please call : 1-800-211-PANA(7262) or send e-mail to : consumerproducts@panasonic.com

***Important:** If a remote control button does not work when pressed, press the VCR button on the remote and try the button again.

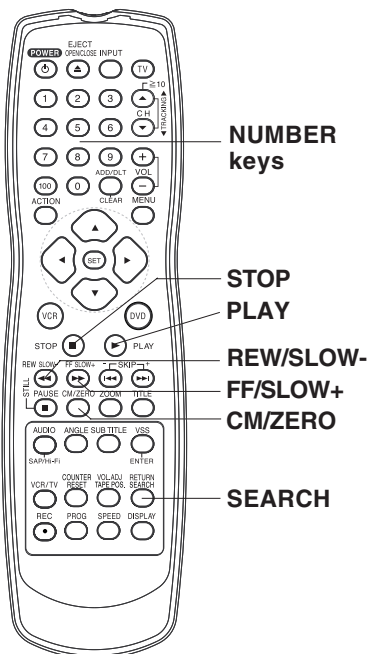

Auto Operation Functions

■ Auto Play

Insert a tape → Power comes on,
→ Play starts if there is no record tab
(see p. 6).

■ Auto Rewind

Play
Fast Forward } → Tape end → Rewind

■ Play Auto Eject

(Repeat Play must be off)
Play → Tape end → Rewind
→ Tape ejects if set some programs.

Commercial Skip

VCR fast forwards (skips) over 1~3 minutes of recorded tape.

1 Press CM/ZERO in Play mode.

- The skip time can be changed by pressing CM/ZERO repeatedly as shown by the figure below.

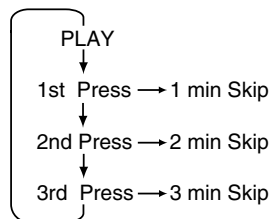

- No indication appears on-screen.

VCR
Operation

Tape Operation (continued)

Repeat Play

Set to playback a recording over and over.

1 Press ACTION*
to display MENU.

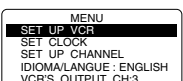
2  Press **▲▼**
to select "SET UP VCR," and
press **SET**.

3  Press **▲▼**
to select "REPEAT PLAY,"
and press **SET**
to set "ON" or "OFF."

- Play repeats at tape end or if unrecorded portion over 30 sec. is detected.

4 Press ACTION twice
to return to normal screen.

Note

- For repeat play in DVD mode, see page 42.

Zero Search

To quickly return to a specified tape location.

1 Press DISPLAY during play
to display Counter.

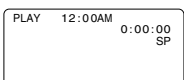
2  Press **COUNTER RESET**
at desired position to reset
to "0:00:00".

3 Continue to record, playback etc.

4 Press STOP.

5  Press **CM/ZERO** in Stop mode
to start Zero Search.



- DECK will go into FF or REW mode and stop at the last point the Counter was set to 0:00:00.

32 For assistance, please call : 1-800-211-PANA(7262) or send e-mail to : consumerproducts@panasonic.com

VCR/TV Selector Feature

The VCR/TV selection can be set to auto or manual.

1 Press ACTION
to display MENU.

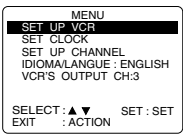
2  Press **▲▼**
to select "SET UP
VCR," and
press **SET**.

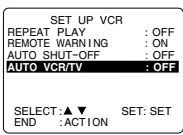
3  Press **▲▼**
to select
"AUTO VCR/
TV," and
press **SET**
to set "ON"
or "OFF."

- OFF(Manual): You select "VCR" or "TV" mode using the VCR/TV button on the remote.
- ON(Auto): "VCR" mode is automatically set when VCR is turned on, or in Play mode.

4 Press ACTION
to return to normal screen.

Note

- For more on VCR/TV selection, see "Record one station, watch another" and "Select channels at DECK" sections (see p. 21).

Special VCR Features

***Important:** If a remote control button does not work when pressed, press the VCR button on the remote and try the button again.

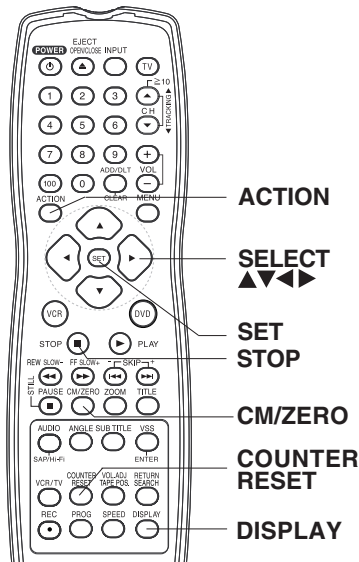

VCR Lock Feature

When set to ON, all operations except for timer record and tape eject are prohibited. Useful for households with small children.

To turn on, hold down REC on DECK in Stop mode with no tape inserted for 7 seconds. (Please ignore "NO CASSETTE" warning.)



To turn off, repeat above.

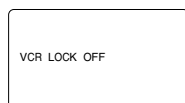

- VCR Lock cancels in 24 hours if clock is set.

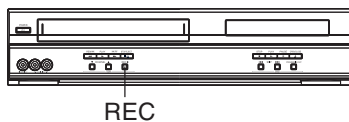

Weak Signal Display Feature

When "ON," picture is displayed regardless of signal strength.

1 Press **ACTION** to display MENU.

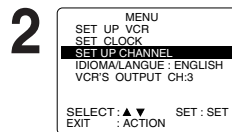

Press **▲▼** to select "SET UP CHANNEL," and press **SET**.

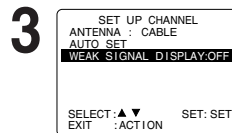

Press **▲▼** to select "WEAK SIGNAL DISPLAY," and press **SET** to set "ON" or "OFF."

- ON: Picture is displayed regardless of signal condition, and may not always be clearly visible.
- OFF: Screen turns solid blue when signal is weak or non-existent.
- Selecting ON has no effect on connected equipment with blue back feature.

4 Press **ACTION** twice to return to normal screen.

Auto Shut-Off Feature

The power shuts off at a preset time.

1 Press **ACTION** to display MENU.

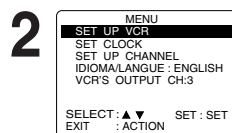

Press **▲▼** to select "SET UP VCR," and press **SET**.

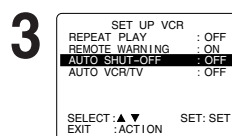

Press **▲▼** to select "AUTO SHUT-OFF." Press **SET** repeatedly to change shutoff time as shown below.

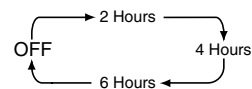

4 Press **ACTION** twice to return to normal screen.

Note

- The shut-off countdown will not function during Play or Record.

Operation VCR

Special VCR Features (continued)

Remote Warning Feature

If Multi-brand feature is used (p. 28), and this feature is set to on, a warning appears whenever an invalid key is pressed in TV mode.

1 Press **ACTION*** to display MENU.

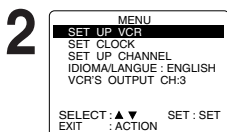

Press **▲▼** to select "SET UP VCR," and press **SET**.

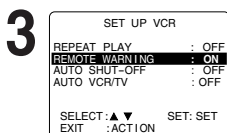

Press **▲▼** to select "REMOTE WARNING," and press **SET** to set "ON" or "OFF."

- If "OFF," remote warning will not appear when invalid key is pressed.

4 Press **ACTION** twice to return to normal screen.

***Important:** If a remote control button does not work when pressed, press the VCR button on the remote and try the button again.

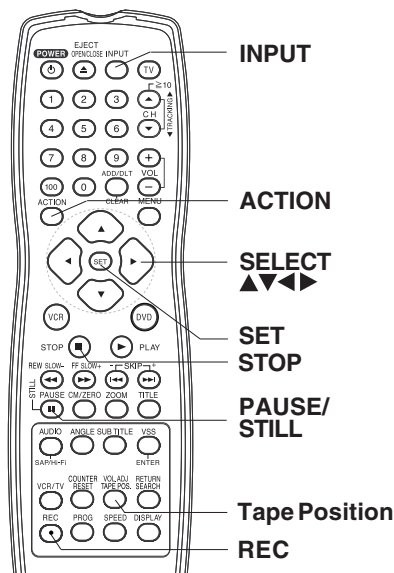

Tape Position and Tape Status Feature

To find out the present tape position and amount of tape remaining. **Tape position is displayed for VHS-C type Cassettes, tapes under 30 minute long, and some other tapes, but the position is not correct.**

1 Press **TAPE POS.** to detect current tape position.

DETECTING TAPE POSITION

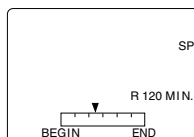

- "DETECTING TAPE POSITION" is displayed only when a cassette is first inserted, and it takes several seconds for correct tape position to appear.
- The present tape position indication and amount of tape remaining (according to tape speed) is displayed.
- Tape remaining time display may not be precise.

2 Press **TAPE POS.** to return to normal screen.

Note

This function cannot display exact amount of tape remaining for tapes 30 minutes or less, or for tapes over 120 minutes in length.

34 For assistance, please call : 1-800-211-PANA(7262) or send e-mail to : consumerproducts@panasonic.com

Copying Your Tapes (Dubbing)

Connection

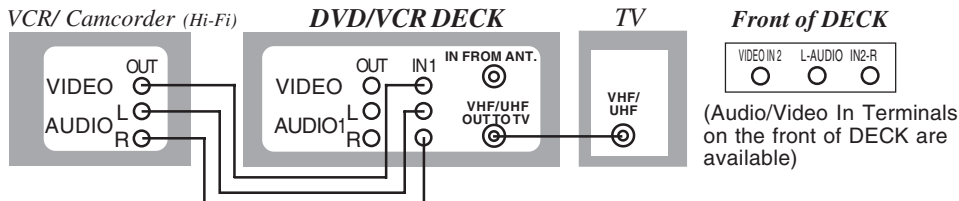

- ① Connect VIDEO OUT terminal on Playing VCR to VIDEO IN terminal on DECK. To monitor the dubbing, also connect TV as shown.
- ② Connect "L" and "R" AUDIO OUT terminals on Playing VCR to "L" and "R" AUDIO IN terminals on DECK.
In place of Playing VCR, you can use other equipment, such as a Camcorder. Simply connect the unit's Audio/Video outputs to DECK.

Playing (Source) VCR

Recording (Editing) DECK

1 Insert a pre-recorded tape.

Insert a blank tape with record tab.

2 _____

Press INPUT to set DECK Input mode to LINE for Video Input.
(See "Selecting the Input Mode" below.)

3 **Press PLAY**, then **PAUSE/STILL** immediately to enter PLAY/PAUSE mode.

Press REC, then **PAUSE/STILL** immediately to enter REC/PAUSE mode.

The operation of steps 4 and 5 must be done on the playing and recording VCRs at the same time.

4 **Press PLAY** to start dubbing. Playing VCR starts playback.

Press PAUSE/STILL to start dubbing. DECK starts recording.

5 **Press STOP** to stop dubbing.

Press STOP to stop dubbing.

■ To Monitor Dubbing on TV

- 1 Turn TV on and tune to the Recording VCR channel (CH 3 or CH 4).
- 2 If Auto VCR/TV (see p.32) is set to "OFF," press VCR/TV on the remote to be VCR mode.

■ Selecting the Input Mode

- Method 1: **Press INPUT** repeatedly.
Channel Number ↔ LINE1 ↔ LINE2
- Method 2: **Press CH ▲/▼**.
Display will change as below.

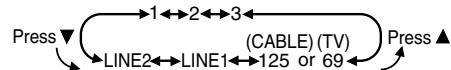

- "L1" or "L2" lights up on Multi Function Display (about 4 seconds) when LINE1 or LINE2 is selected.
- LINE1: For rear audio/video connection.
LINE2: For front audio/video connection.

Note • Dubbing tapes protected with Copy Guard will result in poor quality recordings.

Caution: • Unauthorized exchanging and/or copying of copyrighted recordings may be copyright infringement.
• Please note that some tapes cannot be dubbed on DECK. Also, it is not possible to dub DVD/ Video CD/ CD to VHS tapes using DECK.

Operation
VCR

Disc Operation

Subtitle Language (DVD only)

You can select a different subtitle language (if offered) than the one set at the Settings for DVD Operation. (See p. 47.)

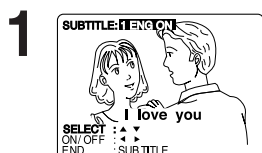

Press SUB TITLE* in Play mode to display the subtitle selection on-screen.

- Display disappears after 5 seconds.
- When no subtitles are offered, “-” will be displayed instead of the language number.



Press ▲▼ to select a language.
Press ◀▶ to select “ON” or “OFF.”

Subtitle language being played back (see chart, right).

Notes

- If after several presses of the button the language does not change, language selection is not offered on the disc.
- When disc is removed, subtitles revert to initial setting language. If the initial language is not recorded on the disc, the disc’s priority language will appear.

Audio Soundtrack Language (DVD only)

You can change the audio soundtrack language, selected at the Settings for DVD Operation, to a different language if available. (See p. 47.)

(This operation works only with discs on which multiple audio soundtrack languages are recorded.)



Press AUDIO in Play mode to display the audio selection on-screen.

- Display disappears after 5 seconds.
- Audio attribute 1 type, sampling frequency, bit No. of the disc or number of speaker channel.



Press ▲▼ to select desired language.

Audio soundtrack language being played back (see chart, above right).

Ready Checklist

- Please read “Basic DVD Operation” on page 22.

[Subtitle language] [Audio sound track language]

ENG	English
FRA	French
DEU	German
ITA	Italian
ESP	Spanish
NLD	Dutch
SVE	Swedish
NOR	Norwegian
DAN	Danish
POR	Portuguese
RUS	Russian
JPN	Japanese
CHI	Chinese
KOR	Korean
MAL	Malay
VIE	Vietnamese
THA	Thai
*	Other

- Change the No. by **pressing ▲▼**, and **press SET**.

[Audio attribute 1 type, sampling frequency, bit No. of the disc (see p. 48.)]

LPCM	96 kHz or 48 kHz	16 bit 20 bit 24 bit	Linear PCM disc
Dolby Digital	1c h - 5.1 ch		Dolby Digital disc
DTS	1 ch - 5.1 ch		DTS disc

Notes

- If, after several presses of the AUDIO button the language does not change, language selection is not offered on the disc.
- When disc is removed, language reverts to initial setting. If this language is not recorded on the disc, the language recorded will be heard.

36

For assistance, please call : 1-800-211-PANA(7262) or send e-mail to : consumerproducts@panasonic.com

*Important: if a remote control button does not work when pressed, press the DVD button on the remote and try the button again.

When  appears on the screen while a button is being operated, it means that the corresponding operation is prohibited by DECK or the disc.

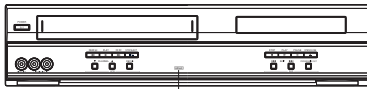

ANGLE Indicator

Notes

- The ANGLE Indicator lights up on DECK when a scene recorded at different angles is detected.
- The angle number can be set beforehand so that the angle is switched whenever the ANGLE Indicator lights up.

Multiple Angle Viewing (DVD only)

DVDs may contain scenes shot from multiple camera angles allowing the same scene to be viewed at different angles. You can view these angles, if available, using the ANGLE button.

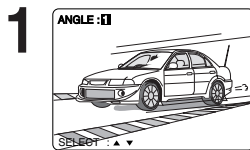

Press ANGLE in Play mode to display the angle selection on-screen.

- Display disappears after 5 seconds.

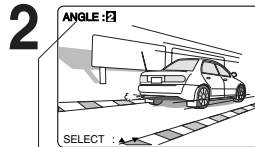

Press ▲▼ to select the desired angle.

Number of angle being played back.

Vocal Selection for Karaoke Discs (DVD/Video CD)

1 Press **AUDIO** in Play mode to display the audio screen.

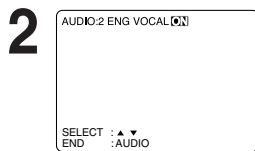

Press ▲▼ (or ◀▶) to select as shown below, and **press ▲ (or ▼)** to set. (DVD only)

- DVD Karaoke (1 vocal) VOCAL ON→VOCAL OFF
- DVD Karaoke (2 vocals) VOCAL V1→VOCAL V2→VOCAL V1+V2→VOCAL OFF
- Video CD LR→L→R

Picture Zoom (DVD only)

You can enlarge specific portions of a picture and select the zoom ratio using the ZOOM button during DVD playback.

Press ZOOM repeatedly to change display as follows.

- You can enlarge the center portion of the image to one of 2 magnifications.

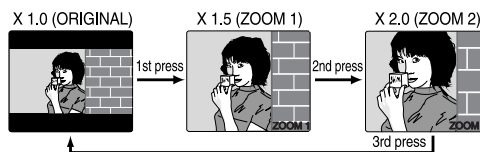

- Use the ▲, ▼, ◀ and ▶ buttons to move the position up, down, left and right.

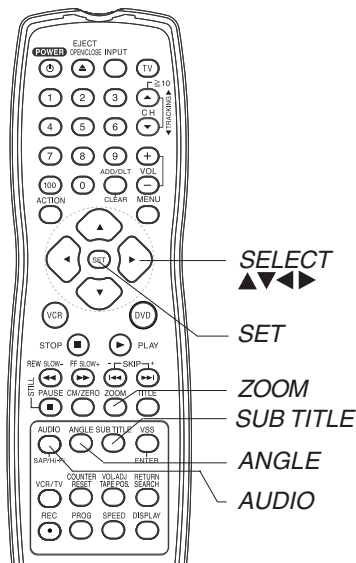

Notes

- The subtitle cannot be enlarged nor can it's position be changed.
- The picture zoom feature does not work with a Video CD.
- During picture zoom, "ZOOM1" or "ZOOM2" appears on-screen for 5 second.
- Zooming, on some discs, may result in poor picture quality, or may not operate at all.

DVD Operation

Disc Operation (continued)

Title Menu (DVD only)

Some DVDs have more than one title, e.g. movies. If the disc offers a title menu, you can select the desired title number. (Operation may vary according to the disc.)

1

TITLE MENU	
Dogs	Castles
Lovers	Birds

<Example>

Press *TITLE** in Play mode to display the title screen.

2

TITLE MENU	
Dogs	Castles
Lovers	Birds

Birds of the world

<Example>

Press \blacktriangle \blacktriangledown \blacktriangleleft \blacktriangleright or *NUMBER* keys to select a title, and **press *SET* or *PLAY*** to start playing.

- "Pressing *SET* or *PLAY*" is not necessary when using *NUMBER* keys.

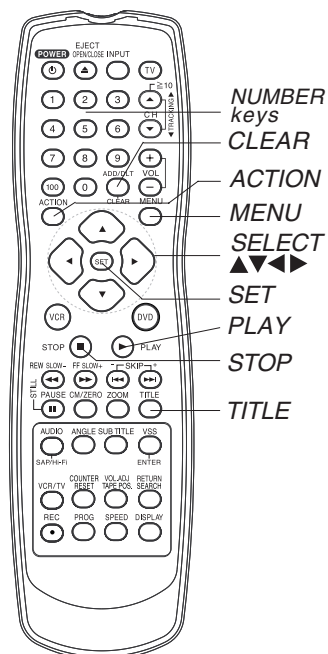

DVD Menu (DVD only)

DVDs may offer a special menu. This menu may include guides to unique contents, audio/subtitle languages, etc. Although contents and operation may vary, the following steps show basic steps for using the menu.

1

DVD MENU	
1. SUBTITLE	
2. AUDIO	
3. ANGLE	

<Example>

Press *MENU* in Play mode to display DVD MENU.

2

DVD MENU	
1. SUBTITLE	
2. AUDIO	
3. ANGLE	

<Example>

Press \blacktriangle \blacktriangledown \blacktriangleleft \blacktriangleright or *NUMBER* keys to select an item, and **press *SET* or *PLAY*** to perform.

- "Pressing *SET* or *PLAY*" is not necessary when using *NUMBER* keys.

Repeat step 2 if there is more than one menu.

38 For assistance, please call : 1-800-211-PANA(7262) or send e-mail to : consumerproducts@panasonic.com

*Important: if a remote control button does not work when pressed, press the DVD button on the remote and try the button again.

Program Play (Video CD/CD only)

You can program specific tracks and order of play.

1 Press **ACTION** to display DVD MAIN MENU.



Press **▲▼** to select "PLAY MODE," and press **SET** to display.

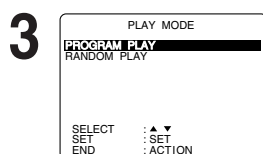

Press **▲▼** to select "PROGRAM PLAY," and press **SET** to display.

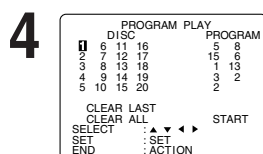

Press **▲▼◀▶** to select a track number (Track numbers on disc are displayed.), and press **SET**.

- Repeat step 4 to select another track.
- The selected track is added on the right side.

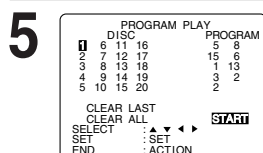

Press **▲▼◀▶** to select "START," and press **SET** to start play of programs in the sequence selected.

- To cancel, press **STOP** during play, then press **CLEAR**.

Notes

- Up to 15 tracks can be programmed.
- "◀" or "▶" (depending on disc) indicates additional PROGRAM PLAY screen. Press **▲▼◀▶** for next or previous screen.
- **To clear the last program one by one**
Press **▲▼◀▶** to move to "CLEAR LAST" and press **SET**. (Pressing **CLEAR** on remote control also clears last program.)
- **To clear all programs**
Press **▲▼◀▶** to move to "CLEAR ALL" and press **SET**. (Programs are also cleared when the power is turned off or the disc is removed.)

Ready Checklist

- DECK is in DVD mode, press DVD.
- Video CD or CD is inserted.

Program Repeat Play (Video CD/CD only)

1 Do operation steps 1 through 5 at left on this page.

2 Press **DISPLAY** to display Disc Information screen. (Disc Information Screen)

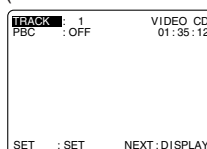

3 Press **DISPLAY** to display DECK Information screen.

4 Press **SET** to enter Select mode. Cursor move to "OFF." (DECK Information Screen)

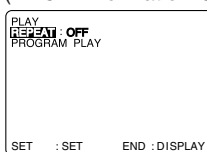

5 Press **▲▼** to select "DISC." (DECK Information Screen)

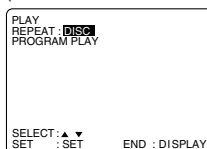

6 Press **SET** to set mode. Cursor move to "REPEAT." To cancel, select "REPEAT : OFF" in step 5, then press **SET**.

DVD Operation

Disc Operation (continued)

Random Play (Video CD/CD only)

Tracks are played in a random order.

1 Press **ACTION*** to display DVD MAIN MENU.

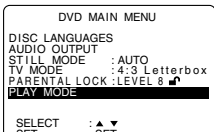
2  Press **▲▼** to select "PLAY MODE," and press **SET** to display.

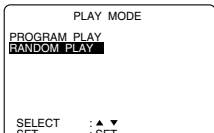
3  Press **▲▼** to select "RANDOM PLAY," and press **SET** to begin random play.

- To cancel, press **STOP** during play, then press **CLEAR**.

Ready Checklist

- DECK is in DVD mode, press DVD.

*Important:

If a remote control button does not work when pressed, press the DVD button on the remote and try the button again.

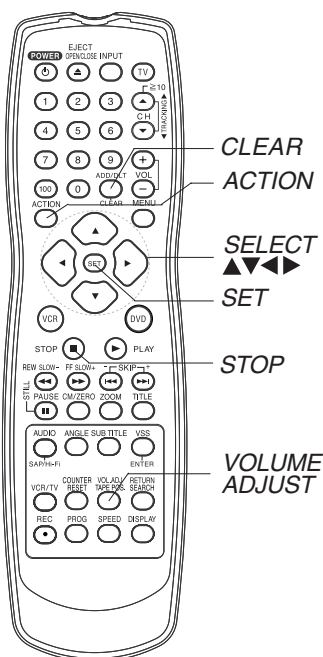

Setting the VOLUME ADJUST

Some DVDs are recorded in lower than average volume levels. For these DVDs, this DECK can be set so that the average volume is increased.

Press **VOL.ADJ** repeatedly to change "ON" ↔ "OFF."

- "ON" or "OFF" lights up on Multi Function Display (about 3 seconds) when press VOL.ADJ.

	VOLUME ADJUST "OFF"	VOLUME ADJUST "ON"
Some DVD [Volume level is low]	Volume is the original level.	Volume level is increased when played back.

- "ON" is set When a DVD is played back, the average volume is increased.
- "OFF" is set The volume level recorded on the disc is played back just as it is.

Notes

- This feature is available only for Dolby Digital sound tracks.
- When audio equipment is connected, setting the Sound Output level to "OFF" is recommended.
- If the sound becomes abnormal while playing a disc, set the Sound Output level to "OFF."

40

For assistance, please call : 1-800-211-PANA(7262) or send e-mail to : consumerproducts@panasonic.com

DVD Operation using On-Screen Displays

When **DISPLAY** is pressed, On-Screen Displays show disc information (title/chapter/track number, elapsed playing time) and DECK information (repeat play, play mode).

✓ Ready Checklist

- DECK is in DVD mode, press DVD.

1 Press **DISPLAY** in Play or Stop mode to display "On-Screen Displays."

- Each press of **DISPLAY** changes the on-screen display as follows. (Refer to p. 42.)

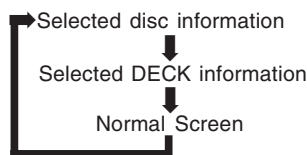

Note

DISPLAY button does not function while DVD TITLE MENU is displayed.

2 Press **▲▼** (or **◀▶**) to select an item, and press **SET**.

3 Press **▲▼** or **NUMBER keys** to select the setting, and press **SET**.

<Example of DVD>

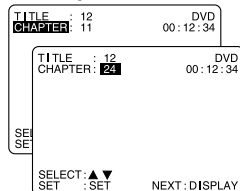

- When numbers are displayed (e.g. title number), **NUMBER keys** are also available.
- If the number entered is not on the disc, the entry will have no effect. Re-enter the correct number.

<Example of Video CD>

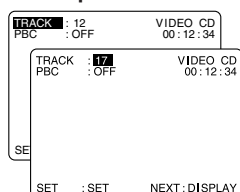

- For more details, refer to the disc operation information.

To return to normal screen, press **CLEAR** or **DISPLAY** repeatedly.

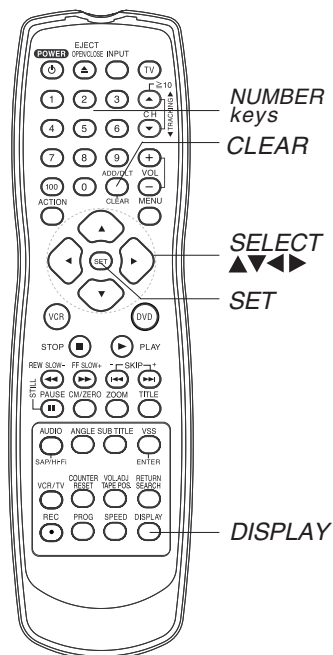

DVD Operation

Notes

- When **DISPLAY** button is pressed during playback of a Video CD with Playback control, **NUMBER keys** are not available on the displayed screen. In this case, press **DISPLAY** again to remove the displayed screen.
- When  appears on the screen while a button is being operated, it means that the corresponding operation is prohibited by DECK or the disc.

DVD Operation using On-Screen Displays (continued)

Detailed Descriptions of each On-Screen Display

Disc information screen (for DVD)

1. TITLE No.

- Select "TITLE", and press **SET**.
- Change the No. by pressing **▲▼** or **NUMBER keys**, and press **SET**.

2. CHAPTER No.

- Select "CHAPTER", and press **SET**.
- Change the No. by pressing **▲▼** or **NUMBER keys**, and press **SET**.

3. Disc currently being played

4. Elapsed playing time

- The screen may be changed by selecting the elapsed time.
- Select the elapsed playing time ("xx:xx:xx"), and press **SET**.
- Change the elapsed time by pressing **NUMBER keys**.
Hours → Minutes → Seconds are entered in order.
- If the time entered is not on the disc, the entry will have no effect. Re-enter the correct time.
- e.g., press 0 - 1 - 2 - 3 - 4 - 5 for 01 : 23 : 45.

Hour Minutes Seconds

- This function does not work with some discs.

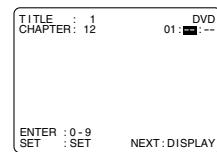
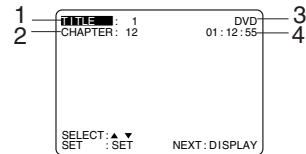

If SET is pressed while making entries, unit returns to the condition it was in before entries were made.

Disc information screen (for Video CD/ CD)

A. TRACK No.

- Select "TRACK", and press **SET**.
- Change the No. by pressing **▲▼** or **NUMBER keys**, and press **SET**.

B. Playback control ON/OFF

[Video CD with playback control only]

ON	Video CD menu play is displayed.
OFF	Video CD menu play is not displayed.

C. Disc currently being played

Video CD | CD

D. Elapsed playing time

Note

- Track No. and the elapsed playing time are not displayed during play started from menu of Video CDs with playback control.
- When appears on the screen while a button is being operated, it means that the corresponding operation is prohibited by DECK or the disc.

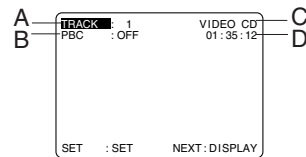

DECK information screen (for DECK)

a. Repeat Play

- Select "REPEAT", and press **SET**.
- Change the desired mode during play by pressing **▲▼**, and press **SET**.

DVD	REPEAT CHAPTER	REPEAT TITLE	REPEAT OFF
Video CD/CD	REPEAT TRACK	REPEAT DISC	REPEAT OFF

b. Play mode [Video CD/ CD only] (See p. 39 or 40.)

PROGRAM PLAY	program play
RANDOM PLAY	random play
----	normal play

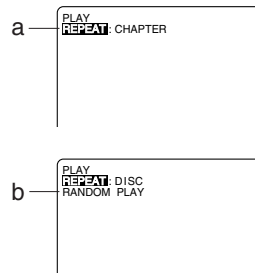

For your reference

CHAPTER/TITLE REPEAT PLAY (DVD)

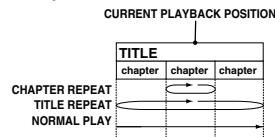

TRACK/DISC REPEAT PLAY (Video CD/CD)

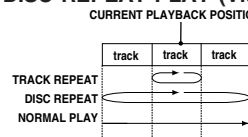

Note

- For repeat play in VCR mode, see p. 32.

42

For assistance, please call : 1-800-211-PANA(7262) or send e-mail to : consumerproducts@panasonic.com

MP3/WMA/JPEG Playback Operation

This unit can play MP3/WMA/JPEG format CD-R or CD-RW recorded for personal use on a PC, etc. Some discs may not play due to the condition of the recording.

1 Press **POWER** on the remote or **DECK**.

2 Press **OPEN/CLOSE**, then place an MP3/WMA/JPEG disc into the disc tray.
Press **OPEN/CLOSE** to close.

3

- MP3/WMA/JPEG menu is displayed.
- Playback starts automatically (except JPEG files).
- CD directory is displayed.

<Example>

Function Status (PLAY 00:00:00)

Folder area (Current folder appears green.)

Counter (00:00:00)

Parent folder (ROOT)

File area (Selected file/folder is highlighted. Titles are displayed up to 11 characters.)

PLAY MODE

:MP3 file :WMA file
:Folder :Parent folder
:JPEG file

<Example> (Diagram left shows CD directory structure as displayed in example OSD above.)

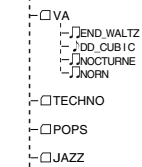

Notes

- Only File (not Folder) area operation is possible.
- Files are displayed in the following order: (!...0,1....9,A,B.....Z).

4

- **Select file** (During STOP mode)
 - 1) Press **▲▼** to select an MP3/WMA file ().
 - ➔ MP3/WMA Playback (see right)
 - 2) Press **▲▼** to select a JPEG file ().
 - ➔ JPEG Playback (see p. 44)
 - 3) Press **SKIP ►►|** (next) or **◀◀ SKIP** (previous) to skip a file/folder page (7files) in the File area.
- **Select folder** (During STOP mode)
 - 1) Press **▲▼** to select a folder (.
 - 2) Press **SET** to display files/folders contained in the folder.
- **Select parent folder** (During STOP mode)
 - 1) Press **▲▼** to select a folder (.
 - 2) Press **SET** to make changes to the previous directory display.

5 Press **ACTION** to return to the DVD MAIN MENU. (➔ Press **ACTION** again to return to the MP3/WMA/JPEG MENU.)

MP3/WMA Playback

Do steps 1~3 on left.

a Press **▲▼** to select an MP3/WMA file (). (During STOP mode)

b Press **SET** or **PLAY** to start playback.

Forward/Reverse Search

- Press **FF/SLOW+** or **REW/SLOW-** during play. Press **PLAY** to release.
- Search speed, slow at first, increases with each additional press of the button up to 5 levels.

Forward/Reverse Track Skip

- Press **SKIP ►►|** or **◀◀ SKIP** during play. Each press skips a track.
- If pressed within first 3 seconds of playback, skips to the previous track. If over 3 seconds, returns to top of track. (**◀◀ SKIP** only.)
- Put DECK in Stop mode before performing folder/file selection (see step 4.)

Pause

- Press **PAUSE** during play.
- Press **PLAY** to release.

c Press **STOP** to stop play.

d Press **OPEN/CLOSE** to eject the disc. The MP3/WMA/JPEG MENU is closed automatically.

Note

- Copyright protected files and files containing errors cannot be played back. The DECK skips to the next file.

Select PLAY MODE [MP3/WMA Playback]

- (During STOP mode)
 - 1) Press **◀►** to move cursor to PLAY MODE.
 - 2) Press **▲▼** to select the desired PLAY MODE (see below).

[PLAY MODE]

NORMAL:

All MP3/WMA files are selected and played back one time only.

SINGLE REPEAT:

The selected MP3/WMA file is played back repeatedly.

FOLDER REPEAT:

The MP3/WMA files contained in the selected folder are played back repeatedly. However, folders below the selected folder are not played back.

DISC REPEAT:

All MP3/WMA files are played back repeatedly.

*Important:

if a remote control button does not work when pressed, press the DVD button on the remote and try the button again.

DVD Operation

MP3/WMA/JPEG Playback Operation (continued)

JPEG Playback

You can play back JPEG images.

Displayable Image Size: 32x32~7680x7680 pixels

Note • Some JPEG format may not be played back.

Do steps 1~3 on page 43.

1 Press **▲▼** to select an JPEG file (📷).

2 Press **SET** or **PLAY**.
Selected JPEG file is displayed.
[JPEG Playback Screen]

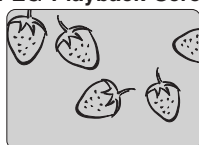

<Example>

- Returned on the MP3/WMA/JPEG MENU
⇒ Press **STOP**. (See p. 43)
- Next/Previous Search
⇒ Press **SKIP▶▶** or **◀◀SKIP**.
- Start Slide-show ⇒ Press **FF/SLOW+** or **REW/SLOW-**. (below)
- Enlarging an image ⇒ Press **ZOOM**. (P. 45)
- Rotating an image ⇒ Press **ANGLE**. (P. 45)

3 Press **STOP** to return to the MP3/WMA/JPEG MENU.

JPEG Slide-show

(During JPEG Playback.)

JPEG files are displayed automatically (about every 3 seconds) as a slide-show.

1 Press **FF/SLOW+** or **REW/SLOW-**.

<Example>

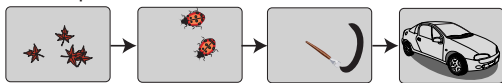

Image changes every 3 seconds.

- Cancel slide show
⇒ Press **STOP** to return to the MP3/WMA/JPEG MENU. (See p. 43)
- Still picture
⇒ Press **STILL** (only SLIDE).
⇒ Press **PLAY** to release.
- Forward/Reverse File Skip
⇒ Press **SKIP▶▶** or **◀◀SKIP**.
Each press skips a file.

2 Press **ACTION** to return to the DVD MAIN MENU.

44

For assistance, please call : 1-800-211-PANA(7262) or send e-mail to : consumerproducts@panasonic.com

■ Select PLAY MODE [JPEG Slide-show]

(During STOP mode) (See p.43)

- 1) Press **◀▶** to move cursor to PLAY MODE.
- 2) Press **▲▼** to select the desired PLAY MODE (see below).

[PLAY MODE]

NORMAL:

All JPEG files are selected and played back one time only.

SINGLE REPEAT:

The selected JPEG file is played back repeatedly.

FOLDER REPEAT:

The JPEG files contained in the selected folder are played back repeatedly. However, folders below the selected folder are not played back.

DISC REPEAT:

All JPEG files are played back repeatedly.

<Example>

Operation can be done when files are in order, such as in the diagram below.

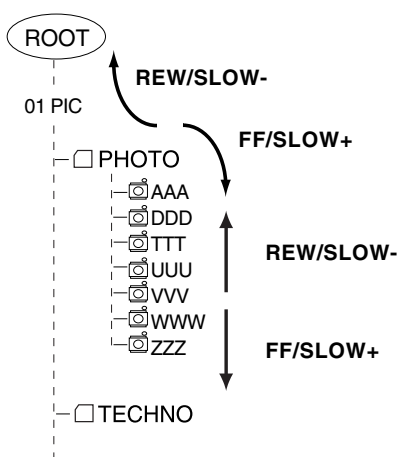

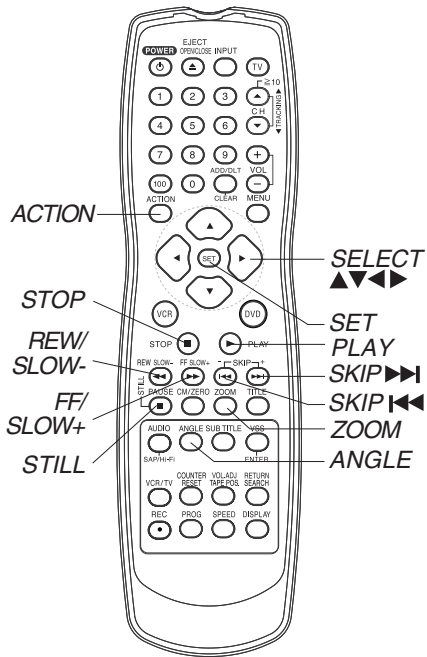

JPEG Zoom

(During JPEG Playback.)

You can enlarge specific portions of a JPEG picture and select the zoom ratio using the ZOOM button on the remote during JPEG Playback screen.

Set Zoom size.

Press **ZOOM** repeatedly to change display as follows.

➔ Press **STOP** to return to the MP3/WMA/JPEG MENU.

- You can enlarge the center portion of the image to one of 2 magnifications.
- Operation can be done during Rotation (below).

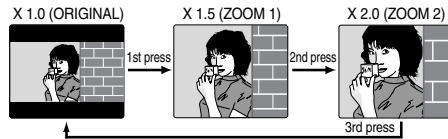

- Use the **▲**, **▼**, **◀** and **▶** buttons to move the position up, down, left and right. (Position cannot be changed on X1.0 ORIGINAL images.)

JPEG Rotation

(During JPEG Playback.)

You can rotate a JPEG picture using the ANGLE button on the remote during JPEG Playback screen. (The JPEG picture will be rotated 90° clockwise.)

Set rotation.

Press **ANGLE** repeatedly to change display as below.

➔ Press **STOP** to return to the MP3/WMA/JPEG MENU.

- Operation can be done during Zoom (above).
- The vertical/horizontal ratio of rotated JPEG images may vary when they are displayed.

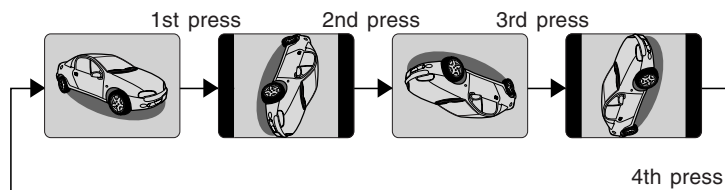

MPEG Layer-3 audio decoding technology licensed from Fraunhofer IIS and Thomson multimedia.

MP3
PLAYBACK

Windows Media, and the Windows logo are trademarks, or registered trademarks of Microsoft Corporation in the United States and/or other countries. WMA is a compression format developed by Microsoft Corporation. It achieves the same sound quality as MP3 with a file size that is smaller than that of MP3.



DVD
Operation

DVD Lock Feature

***Important:** If a remote control button does not work when pressed, press the DVD button on the remote and try the button again.

You can prevent playback of DVDs of a specific rating level which may be unsuitable for children.

- Some DVDs are encoded with a rating level. If the disc rating is higher (stricter) than the one you preset, playback will be prohibited.

DVD Lock (DVD only)

A 4-digit code must be entered to view a blocked program or change rating settings.

1 Press **ACTION*** to display DVD MAIN MENU.

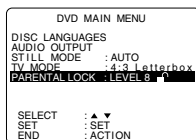

Press **$\blacktriangle\blacktriangledown$** to select "PARENTAL LOCK," and press **SET** to display.

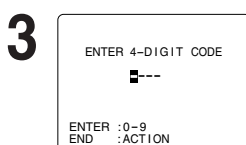

- 1) Press **NUMBER keys** to enter your secret code.
- 2) Enter same secret code again for confirmation.
- 3) Press **SET** to display.

To Make Corrections
Press **\blacktriangleleft** repeatedly to move the cursor.
Press **NUMBER keys** to make the correction.

- Step 2) not necessary when changing rating or secret code.
- Take care that you are not observed entering the secret code.

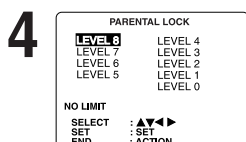

Press **$\blacktriangle\blacktriangledown\blacktriangleleft\blacktriangleright$** to select rating level, and press **SET** to select "LOCKED" or "UNLOCKED."

LEVEL 0 : LOCK ALL, Playback of all DVDs, CDs, Video CDs, MP3, WMA and JPEG is prohibited.
(Use to prohibit play of mature theme DVDs not encoded with rating level.)

LEVEL 1 : mature theme DVDs

LEVEL 2 : DVDs expressly for children can be played back.

LEVEL 3 to 7 : DVDs for general audiences/children can be played back. (DVDs with mature content are prohibited.)

LEVEL 8 : NO LIMIT: (Factory preset)
All DVDs can be played back.

Ready Checklist

- DECK is in DVD mode, press DVD.

Caution

Discs not encoded with rating level will play even if the jacket states it is for mature audiences. For these discs, the DVD Lock Ratings will not work.

<When DVD Lock is activated>

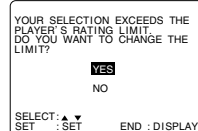

After DVD Lock is set and a blocked DVD is played, this message will appear. The message may differ depending on the disc.

To continue viewing a blocked program for now,

Press **$\blacktriangle\blacktriangledown$** to select "YES" and SET. Then, enter your 4 digit secret code (see step 3 left).

When "NO" is selected, blocked programs cannot be viewed.

<When blocked programs>

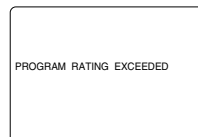

Change your secret code

- You will need your current code. Do steps 1 ~ 2 left. Enter current secret code. Press **CLEAR** to clear the code. Do step 4 to enter new code.

Note

- DO NOT forget your secret code.

Settings for DVD Operation

1 Press ACTION to display DVD MAIN MENU.

2 Press **▲▼** to select an item, and press **SET**.

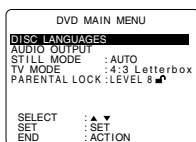

DISC LANGUAGES (See below)
All languages offered on the disc can be set. If the language not offered is set, the original disc language will be selected.

AUDIO OUTPUT (See p. 48.)
You can set the audio output that comes from the digital audio output terminal.

STILL MODE (See p. 49.)
To select "FIELD" (Field still) or "FRAME" (Frame still) to prevent jitter or make small text or fine patterns clearly visible in a still picture. When "AUTO" is set "FIELD" or "FRAME" is selected automatically.

TV MODE (See p. 49.)
To select whether the video material for a wide-screen will be played back in the Pan & Scan style, Letterbox style or 16 : 9 style.

Disc Languages (DVD only)

To select and set the language of the audio soundtrack, subtitles, or title/DVD menus for all discs to be played.

3 Press **▲▼** to select "DISC LANGUAGES," and press **SET** to display screen.

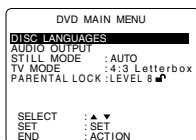

4 Press **▲▼** to select an item, and press **SET** repeatedly for desired language. (Please refer right.)

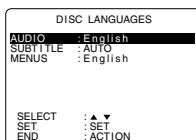

5 Press ACTION to redisplay DVD MAIN MENU and go to step 2 to setup another item.
Or, press **ACTION** twice to exit.

Once initial settings are done, they remain in memory (even after power off) until changed. This means DECK will operate under the same conditions (especially DVDs) each time.

Ready Checklist
 DECK is in DVD mode, press DVD.

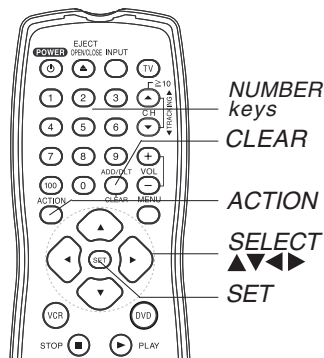

"AUDIO" selections

(Factory preset: English)
To select the audio soundtrack language.
English/Spanish/French/Japanese
Original: Original disc language
OTHER **:** Other language selection*1

"SUBTITLE" selections

(Factory preset: AUTO)
To select the subtitle language.
AUTO: Same language selected for "AUDIO"
• If language set for "AUDIO" is used in playback, subtitles will not appear.
• If another language is used during playback, the subtitles will appear in the language selected at "AUDIO" setup.

English/Spanish/French/Japanese
OTHER **:** Other language selection*1

"MENU" selections

(factory preset: English)
To select the language used in title menus or DVD menus.
English/Spanish/French/Japanese
OTHER **:** Other language selection*1

To enter OTHER ** code number,**
Press **NUMBER keys** (Please refer to language codes on page 50).
To make corrections, press **◀** repeatedly to delete language code number, and correct.

*1 If the selected language is not offered, the original disc language is selected.

DVD Operation

Settings for DVD Operation (continued)

Audio Output

Select the digital output to be output from the optical digital audio output connector of DECK.

1 Press **ACTION*** to display DVD MAIN MENU.

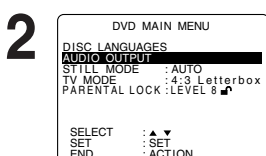

Press **▲▼** to select "AUDIO OUTPUT," and press **SET** to display screen.

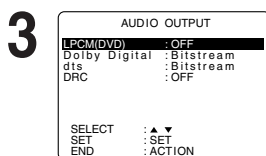

Press **▲▼** to select an item, and press **SET** repeatedly for output. (See below.)

■ "LPCM (DVD)" selections

OFF: Linear PCM of less than 48 kHz/16 bit is output. When playing DVDs recorded in linear PCM of over 48 kHz/20 bit, no digital audio is output. (Factory preset)

PCM: When playing DVDs recorded in linear PCM of 48 kHz/20 bit/24 bit or more, digital audio converted to 44.1 kHz/16 bit or 48 kHz/16 bit is output. (Digital output of PCM audio is restricted to 48 kHz/16 bit or below for copyright protection.)

■ "Dolby Digital" selections

Bitstream: Dolby Digital bitstream (1 ch - 5.1 ch) is output. (Factory preset)

PCM: When you have connected a amplifier that doesn't have a built-in Dolby Digital decoder.

■ "dts" selections

Bitstream: DTS bitstream is output. (Factory preset)

PCM: When you have connected a amplifier that doesn't have a built-in DTS decoder.

■ "DRC (Dynamic Range Compression)" selections

OFF: Normal audio range is selected. (Factory preset)

ON: For dynamic sound even at low volume, this is useful for late-night listening. [Dolby Digital DVDs only].

4 Press **ACTION** to redisplay DVD MAIN MENU and go to step 2 to setup another item.

Or, press **ACTION** twice to exit.

48

For assistance, please call : 1-800-211-PANA(7262) or send e-mail to : consumerproducts@panasonic.com



Ready Checklist

DECK is in DVD mode, press DVD.

Type of amplifier to be connected	Recommended setting		
	LPCM (DVD)	Dolby Digital	DTS
No amplifier is connected	---	---	---
AV amplifier (with digital audio input connector) without Dolby Digital/DTS decoder	PCM	PCM*1	PCM*1
AV amplifier including Dolby Digital decoder	PCM	Bitstream	PCM
AV amplifier including Dolby Digital/DTS decoder	PCM	Bitstream	Bitstream*2

• Make settings according to amplifier connected to optical audio output as shown in above table.

*1 When connecting an amplifier (with an optical digital input connector) which does not contain the Dolby Digital or DTS decoder, be sure to select "PCM". If "Bitstream" is selected, starting DVD play may cause such a high level of noise as to be harmful to your ears and damage the speakers.

*2 When a DTS decoder is connected, please select "Bitstream" in "dts".

***Important:** If a remote control button does not work when pressed, press the DVD button on the remote and try the button again.

Still Mode

Set to reduce jitter in a displayed still picture or a motion picture.

1 Press **ACTION** to display DVD MAIN MENU.



Press **▲▼** to select "STILL MODE," and press **SET** repeatedly for mode. (See below.)

AUTO: "FIELD" (Field still) or "FRAME" (Frame still) is automatically selected during the still mode. (Factory preset)

FIELD: "FIELD" (Field still) is always selected. This setting will reduce jitter when compared with "AUTO" on some discs.

FRAME: "FRAME" (Frame still) is always selected. Some texts and fine patterns will be seen clearly when compared with "AUTO" on some discs.

3 Press **ACTION** to exit this mode.

TV Mode

Set the screen display style for wide-screen video material playback.

1 Press **ACTION** to display DVD MAIN MENU.

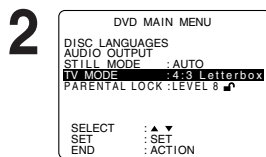

Press **▲▼** to select "TV MODE," and press **SET** repeatedly for mode. (See below.)

4:3 Pan & Scan (Factory preset) :
 Wide-screen video data is played in Pan & Scan style (left and right of screen is trimmed.)
 • Video data not formatted in Pan & Scan will play in letterbox style.

4:3 Letterbox :
 Wide-screen video data is played in Letterbox style (top and bottom of screen has black margin).

16:9 :
 Set "16:9" when using Wide-screen TV.

3 Press **ACTION** to exit this mode.

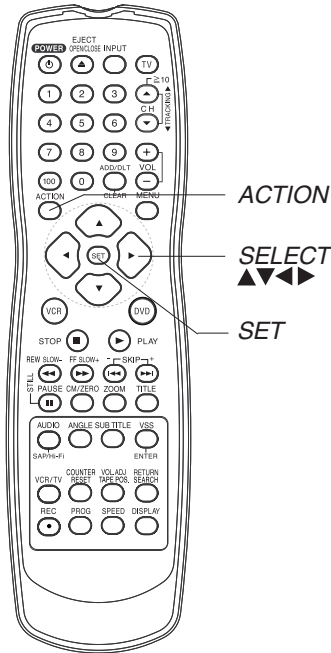

Example

- Pan & Scan (Factory preset)

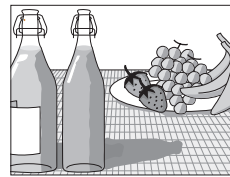

- Letterbox

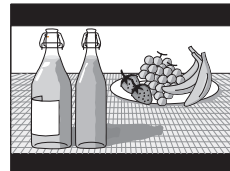

DVD Operation

Language Code List

Enter the appropriate code number for the initial settings "AUDIO", "SUBTITLE" and/or "MENUS" (see p. 47).

Code	Language	Code	Language	Code	Language	Code	Language
6565	Afar	7079	Faroese	7678	Lingala	8375	Slovak
6566	Abkhazian	7082	French	7679	Laothian	8376	Slovenian
6570	Afrikaans	7089	Frisian	7684	Lithuanian	8377	Samoan
6577	Ameharic	7165	Irish	7686	Latvian, Lettish	8378	Shona
6582	Arabic	7168	Scots Gaelic	7771	Malagasy	8379	Somali
6583	Assamese	7176	Galician	7773	Maori	8381	Albanian
6588	Aymara	7178	Guarani	7775	Macedonian	8382	Serbian
6590	Azerbaijani	7185	Gujarati	7776	Malayalam	8385	Sundanese
6665	Bashkir	7265	Hausa	7778	Mongolian	8386	Swedish
6669	Byelorussian	7273	Hindi	7779	Moldavian	8387	Swahili
6671	Bulgarian	7282	Croatian	7782	Marathi	8465	Tamil
6672	Bihari	7285	Hungarian	7783	Malay	8469	Telugu
6678	Bengali; Bangla	7289	Armenian	7784	Maltese	8471	Tajik
6679	Tibetan	7365	Interlingua	7789	Burmese	8472	Thai
6682	Breton	7378	Indonesian	7865	Nauru	8473	Tigrinya
6765	Catalan	7383	Icelandic	7869	Nepali	8475	Turkmen
6779	Corsican	7384	Italian	7876	Dutch	8476	Tagalog
6783	Czech	7387	Hebrew	7879	Norwegian	8479	Tonga
6789	Welsh	7465	Japanese	7982	Oriya	8482	Turkish
6865	Danish	7473	Yiddish	8065	Panjabi	8484	Tatar
6869	German	7487	Javanese	8076	Polish	8487	Twi
6890	Bhutani	7565	Georgian	8083	Pashto, Pushto	8575	Ukrainian
6976	Greek	7575	Kazakh	8084	Portuguese	8582	Urdu
6978	English	7576	Greenlandic	8185	Quechua	8590	Uzbek
6979	Esperanto	7577	Cambodian	8277	Rhaeto-Romance	8673	Vietnamese
6983	Spanish	7578	Kannada	8279	Romanian	8679	Volapük
6984	Estonian	7579	Korean	8285	Russian	8779	Wolof
6985	Basque	7583	Kashmiri	8365	Sanskrit	8872	Xhosa
7065	Persian	7585	Kurdish	8368	Sindhi	8979	Yoruba
7073	Finnish	7589	Kirghiz	8372	Serbo-Croatian	9072	Chinese
7074	Fiji	7665	Latin	8373	Singhalese	9085	Zulu

Warning and Instruction Displays

These displays will alert you to a missed operation or provide further instructions.

OSD	Caution	Page
PLEASE SET CLOCK BY PRESSING ACTION KEY	If you attempt to set or review a Timer Recording and the Clock is not set...	24
PLEASE PREPARE FOR TIMER REC	If DECK is not in Stop mode or a cassette with record tab is not inserted 2 minutes before a Timer Recording is about to begin...	24 25
CHECK CASSETTE RECORD TAB	If you press REC on the remote control or DECK, and a cassette is inserted with no record tab...	6
NO CASSETTE	If you press PLAY, FF, REW, or REC on the remote control or DECK without a cassette inserted...	20 21
TO CANCEL TIMER REC HOLD DOWN STOP KEY FOR APPROX 3 SEC	If you press STOP or POWER during a Timer Recording... (visible in VCR mode only)	25
VIDEO HEADS MAY NEED CLEANING PLEASE INSERT HEAD CLEANING CASSETTE OR REFER TO MANUAL END : PLAY	If head cleaning becomes necessary while playing back a tape...	6
VCR LOCK ACTIVATED	If you press a function button other than STOP/EJECT or POWER while DECK is in VCR Lock mode...	33
REMOTE CONTROL IS SET TO TV MODE USE VCR : VCR KEY USE DVD : DVD KEY	If you press an invalid key on the remote while in TV mode...	28 29 34
PLEASE CHECK THE DISC, AND FOR STAINS OR SCRATCHES ON DISC	If you press PLAY, and DECK reads data from a stained or scratched disc in DVD mode.	4
THIS DISC MAY NOT BE PLAYED IN YOUR REGION	Playback of a disc with different region number was attempted. Only discs marked region "1", "ALL", or those that include "1" are playable on this DECK.	3
THIS TYPE OF DISC CANNOT BE PLAYED. PLEASE INSERT A DIFFERENT DISC	An unusable disc is inserted in the DECK.	4
CANNOT PLAY THIS FILE	This file format cannot be played. (Appears during MP3/WMA/JPEG file playback)	43
THIS FILE IS PROTECTED	This file is copyright protected and cannot be played back. (Playback is prohibited.) [WMA only]	43
IT IS PROHIBITED TO COPY DVD/VIDEO CD/CD TO VHS	If you press REC in DVD mode...	21

For Your Information

Before Requesting Service

Check the following points if you are having trouble with your DECK.

Power	Correction
No power...	<ul style="list-style-type: none"> • Completely insert Power Plug into an AC outlet. • Set POWER button to on. • Make sure power source is active.
Power turns itself off...	<ul style="list-style-type: none"> • Auto power-off (shutoff) occurs after about 5 min. in DVD mode with no operation, or if there is no broadcast signal in TV or Playback mode. Turn the power back on. (pp. 23, 33)
Recording & Playback	Correction
TV program cannot be recorded...	<ul style="list-style-type: none"> • Check connections between DECK, external antenna, and TV. • Check channel selections. • Make sure your antenna system (CABLE or TV) is correctly set. (Channels [p. 18]) • Make sure cassette record tab is intact. (p. 6)
Timer recording cannot be performed...	<ul style="list-style-type: none"> • Confirm that clock is set to current time and date. • Make sure Cable/DSS box (if used) is left on and tuned to channel to be recorded. • Set recording start/stop times correctly. (p. 24) • Timer recording may not be performed or continued if a power interruption occurs before or during a Timer Recording, even after power is restored.
There is no playback picture, or the playback picture is noisy or contains streaks...	<ul style="list-style-type: none"> • Select channel 3 or 4 on TV to match VCR output channel (3 or 4) (p. 16) or select LINE. • Set VCR/TV selector to "VCR." • Adjust TRACKING control in either direction. (p. 6) • Try Head Cleaning. (p. 6)
During special effects playback, picture may contain some vertical jitter when using a TV with an Automatic Vertical Hold Control...	<ul style="list-style-type: none"> • Set TV's Vertical Hold Control to MANUAL, then adjust.
DECK cannot be controlled...	<ul style="list-style-type: none"> • Make sure DECK power is on. • Check Remote batteries. • Make sure VCR LOCK is set to off. (p. 33) • Make sure Remote is in proper mode. (p. 28) • Make sure Timer Recording is not in progress.
Remote Control	Correction
DECK cannot be remote controlled...	<ul style="list-style-type: none"> • Make sure DECK power is on. • Make sure Remote is in VCR mode. • Aim Remote Control directly at remote sensor on DECK. (p.9) • Avoid any object blocking signal path. • Check Remote batteries. (p. 4) • Exposing DECK remote sensor to direct fluorescent or outdoor light may cause signal interference.
PROG buttons do not respond...	<ul style="list-style-type: none"> • PROG functions are not available in COMPONENT Video Output and S-VIDEO OUT. Set TV to either RF IN or VIDEO IN. (p. 10) • Check Remote batteries. (p. 4) • Press VCR or DVD button for DVD/VCR mode. (p. 28)

Check the following points if you are having trouble with your DECK.

DVD/ Video CD/ CD	Correction
Play fails to start even when PLAY is pressed...	<ul style="list-style-type: none"> This DECK cannot play discs other than DVDs, Video CDs and CDs. The disc may be dirty and require cleaning.
Play starts but then stops immediately...	<ul style="list-style-type: none"> Be sure disc is installed with label side up.
Picture is distorted during rapid advance or rapid reverse...	<ul style="list-style-type: none"> The picture will be somewhat distorted at times: this is normal.
No Forward/Reverse Scene Search play...	<ul style="list-style-type: none"> Some discs may have sections which prohibit Forward/Reverse Scene Search. (p. 23)
Play does not start even when title is selected...	<ul style="list-style-type: none"> Confirm the "DVD LOCK" setting. (p. 46)
Audio soundtrack and/or subtitle language is not the one selected at the initial settings...	<ul style="list-style-type: none"> If the audio soundtrack and/or subtitle language selected at DVD initial settings does not exist on the disc, it will not be accessible.
No subtitles...	<ul style="list-style-type: none"> Subtitles appear only when available on disc. "OFF" is selected at the changing subtitle language. Select "ON" at the "Subtitle Languages" section (p. 36) to display the subtitles.
Alternative audio soundtrack (or subtitle) language cannot be selected...	<ul style="list-style-type: none"> Alternative language cannot be selected with discs which do not contain more than one language. For some discs, alternative language cannot be selected with the AUDIO or SUB TITLE button. Try selecting it from the DVD MAIN MENU if available.
Angle cannot be changed...	<ul style="list-style-type: none"> This function is dependent on software availability. Even if disc has multiple angles, they may be recorded for specific scenes only (ANGLE indicator on DECK lights up). (p. 37)
Miscellaneous	Correction
Programs cannot be viewed on TV...	<ul style="list-style-type: none"> Make sure TV is set to output of DECK. Check connections between DECK, external antenna, and TV. Set VCR/TV selector to "TV." (p. 21) Make sure proper signal source is selected.
Video cassette cannot be inserted...	<ul style="list-style-type: none"> Insert the cassette with window side up; record tab facing you.
Video cassette ejects when a recording is started or the power is turned off for timer recording...	<ul style="list-style-type: none"> Make sure cassette record tab is intact. (p. 6)
In Stop mode, the motor (CYLINDER) continues to rotate...	<ul style="list-style-type: none"> To enable Quick play mechanism, the cylinder will rotate for about 3 minutes. This reduces response time from Stop to Play mode.
The disc cannot be removed..	<ul style="list-style-type: none"> First, unplug DECK. Then, prepare a rigid wire (e.g. an extended paper clip) and, applying moderate force, insert it straight into the hole at the base of the tray. The tray will eject a little. Now, pull the tray all the way out and remove the disc. (p. 9)

For Your Information

If you cannot resolve the problem, please call the Customer Call Center for product assistance at 1-800-211-PANA (7262). To locate an authorized servicenter, please call toll free 1-800-211-PANA (7262). or send e-mail to : consumerproducts@panasonic.com

Limited Warranty

PANASONIC CONSUMER ELECTRONICS COMPANY,
DIVISION OF MATSUSHITA ELECTRIC
CORPORATION OF AMERICA
One Panasonic Way
Secaucus, New Jersey 07094

PANASONIC SALES COMPANY,
DIVISION OF MATSUSHITA
ELECTRIC OF PUERTO RICO, INC.,
AVE. 65 de Infantería, Km. 9.5
San Gabriel Industrial Park
Carolina, Puerto Rico 00985

Panasonic DVD/VCR Deck Limited Warranty

Limited Warranty Coverage

If your product does not work properly because of a defect in materials or workmanship, Panasonic Consumer Electronics Company or Panasonic Sales Company (collectively referred to as "the warrantor") will, for the length of the period indicated on the chart below, which starts with the date of original purchase ("Limited Warranty period"), at its option either (a) repair your product with new or refurbished parts, or (b) replace it with a new or a refurbished product. The decision to repair or replace will be made by the warrantor.

Product or Part Name	Parts	Labor
DVD/VCR Deck	One (1) Year	Ninety (90) Days
Rechargeable Batteries (in exchange for defective item)	Ten (10) Days	Not Applicable

During the "Labor" Limited Warranty period there will be no charge for labor. During the "Parts" warranty period, there will be no charge for parts. You must mail-in your product during the warranty period. If non-rechargeable batteries are included, they are not warranted. This Limited Warranty only applies to products purchased and serviced in the United States or Puerto Rico. This Limited Warranty is extended only to the original purchaser and only covers product purchased as new. A purchase receipt or other proof of original purchase date is required for Limited Warranty service.

Mail-In Service

For assistance in the continental U.S.A. in obtaining repairs please ship the product to:

Panasonic Services Company
Customer Servicenter
Suite B
4900 George McVay Drive
McAllen, TX 78503

For assistance in Puerto Rico call Panasonic Sales Company (787)-750-4300 or fax (787)-768-2910.

When shipping the unit carefully pack and send it prepaid, adequately insured and preferably in the original carton. Include a letter detailing the complaint and provide a day time phone number where you can be reached.

IF REPAIR IS NEEDED DURING THE LIMITED WARRANTY PERIOD THE PURCHASER WILL BE REQUIRED TO FURNISH A SALES RECEIPT/PROOF OF PURCHASE INDICATING DATE OF PURCHASE, AMOUNT PAID AND PLACE OF PURCHASE. CUSTOMER WILL BE CHARGED FOR THE REPAIR OF ANY UNIT RECEIVED WITHOUT SUCH PROOF OF PURCHASE.

Limited Warranty Limits And Exclusions

This Limited Warranty ONLY COVERS failures due to defects in materials or workmanship, and DOES NOT COVER normal wear and tear or cosmetic damage. The Limited Warranty ALSO DOES NOT COVER damages which occurred in shipment, or failures which are caused by products not supplied by the warrantor, or failures which result from accidents, misuse, abuse, neglect, mishandling, misapplication, alteration, faulty installation, set-up adjustments, misadjustment of consumer controls, improper maintenance, power line surge, lightning damage, modification, or commercial use (such as hotel, office, restaurant, or other business), rental use of the product, or service by anyone other than a Factory Servicenter or other Authorized Servicer, or damage that is attributable to acts of God.

THERE ARE NO EXPRESS WARRANTIES EXCEPT AS LISTED UNDER "LIMITED WARRANTY COVERAGE". THE WARRANTOR IS NOT LIABLE FOR INCIDENTAL OR CONSEQUENTIAL DAMAGES RESULTING FROM THE USE OF THIS PRODUCT, OR ARISING OUT OF ANY BREACH OF THIS WARRANTY. (As examples, this excludes damages for lost time, cost of having someone remove or re-install an installed unit if applicable, travel to and from the servicer, loss of or damage to media or images, data or other recorded content. The items listed are not exclusive, but are for illustration only.)

ALL EXPRESS AND IMPLIED WARRANTIES, INCLUDING THE WARRANTY OF MERCHANTABILITY, ARE LIMITED TO THE PERIOD OF THE LIMITED WARRANTY.

Some states do not allow the exclusion or limitation of incidental or consequential damages, or limitations on how long an implied Limited Warranty lasts, so the exclusions may not apply to you.

This Limited Warranty gives you specific legal rights and you may also have other rights which vary from state to state. If a problem with this product develops during or after the Limited Warranty period, you may contact your dealer or Servicenter. If the problem is not handled to your satisfaction, then write to the warrantor's Consumer Affairs Department at the addresses listed for the warrantor.

PARTS AND SERVICE, WHICH ARE NOT COVERED BY THIS LIMITED WARRANTY, ARE YOUR RESPONSIBILITY.

Customer Services Directory

For Product Information, Operating Assistance, Literature Request, Dealer Locations, and Customer Service inquiries please visit Web Site:

<http://www.panasonic.com>

You can purchase parts, accessories, locate your nearest servicenter and more by visiting our Web Site or E-mail us via web:

http://www.panasonic.com/consumer_electronics/support/customerfeedback.asp

Contact:

1-800-211-PANA (7262),

Monday-Friday 9 am-9 pm; Saturday-Sunday 10 am-7 pm, EST.

For hearing or speech impaired TTY users, TTY : 1-877-833-8855

Accessory Purchases

1-800-332-5368 (Customer Orders Only)

1-800-237-9080 (Fax Only)

(Monday-Friday 9 am-8 pm, EST.) Panasonic Services Company

20421 84th Avenue South, Kent, WA 98032

(Accepts Visa, MasterCard, Discover Card, American Express, and Personal Check)

<http://www.pasc.panasonic.com> or email to parts@panasonic.com

For hearing or speech impaired TTY users, TTY : 1-866-605-1277

Service in Puerto Rico

Matsushita Electric of Puerto Rico, Inc. Panasonic Sales Company/ Factory Servicenter:

Ave. 65 de Infantería, Km. 9.5, San Gabriel Industrial Park, Carolina, Puerto Rico 00985

Phone (787)750-4300 Fax (787)768-2910

For Your
Information

As of May 2003

55

Spanish Quick Use Guide/ Guía para rápida consulta

CONEXIONES/CONFIGURACION INICIAL (READY TO PLAY)

Realice la conexión de la antena o TV por cable antes de enchufar el cable de CA.

El DVD/VCR iniciará automáticamente la fijación de los canales y del reloj al enchufar el cable de CA.

CONEXIONES

Para Ant/Cable → DVD/VCR → TV

- 1 Conecte el cable de la antena al terminal IN FROM ANT del DVD/VCR.
- 2 Conecte el terminal OUT TO TV del DVD/VCR a la entrada de la antena VHF/UHF del TV con el cable RF incluido.

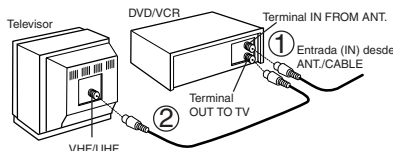

Para Sistema Digital de Satellite (DSS)/ Convertidor de cable → DVD/VCR → TV

- 1 Conecte la salida de convertidor de cable al terminal IN FROM ANT.
- 2 Conecte el terminal OUT TO TV del DVD/VCR a la entrada de la antena VHF/UHF del TV con el cable RF incluido.

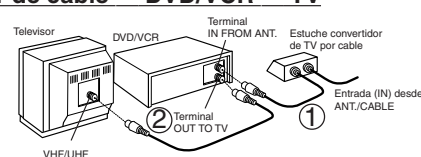

CONFIGURACION INICIAL

1 Encienda el TV y cambie al canal 3.

2 Enchufe el cable de CA. El DVD/VCR se encenderá e iniciará las fijaciones de los canales y del reloj.

- Si no aparece la pantalla de abajo, compruebe la conexión del DVD/VCR-TV y si el canal del TV está a 3, intente cambiando al canal 4.
- Para cambiar el canal de salida del DVD/VCR, consulte las instrucciones de "Canal de salida del VCR" (informaciones en inglés página 19).

Enchufe el cable de CA.

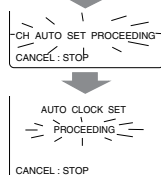

Al inicio, el idioma de la pantalla está fijado a inglés.

Para cambiar el idioma, seleccione la pantalla MENU (informaciones en inglés página 18).

Si está usando un convertidor de TV por cable y en su área hay un canal de Public Broadcast Station (PBS), ajuste su convertidor al canal PBS de su área. Si está usando un receptor DSS, este debe estar apagado.

Nota

- Los botones de funciones no funcionan durante la configuración inicial.
- Para retirar un cassette durante el ajuste automático, presione EJECT en el control remoto o STOP dos veces en el aparato. En este caso, los ajustes de los canales y la hora se deben hacer manualmente. Para los ajustes seleccione la pantalla MENU (informaciones en inglés página 18).
- Dependiendo de las condiciones, el ajuste automático puede durar más de 30 minutos. En ese caso, presione STOP para detener el ajuste automático y realice los ajustes manualmente en la pantalla MENU.

3 Las fijaciones se realizan automáticamente. Cuando termina las fijaciones, aparecerá la siguiente pantalla.

```
6/ 8/2003 SUN 2:20PM
DST:ON
SETTING : CH 10
AUTO CLOCK SET
COMPLETED
```

Si aparece en la pantalla "AUTO CLOCK SET IS INCOMPLETE (FIJACION AUTOMATICA DEL RELOJ ES INCOMPLETO)", Ajuste el reloj como se describe a continuación.

```
AUTO CLOCK SET IS
INCOMPLETE
PLEASE SET CLOCK BY
PRESSING ACTION KEY
```

AJUSTE MANUAL DEL RELOJ

Si la fijación ha sido incompleta.

1 Presione la tecla ACTION en el control remoto para visualizar la pantalla del menú SET CLOCK.

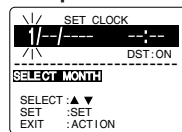

2 Presione ▲ ▼ para seleccionar el mes y SET para ajustar. De la misma forma, seleccione y ajuste la fecha, año, hora y DST (hora de verano).

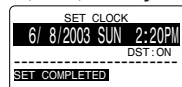

3 Presione dos veces la tecla ACTION para poner el RELOJ en marcha y salir.

PRECAUCIÓN

Al usar cables coaxiales RF del tipo "tuerca", apriételos solamente con los dedos. Un apriete excesivo puede dañar los terminales.

Operaciones básicas para la reproducción

- 1 Inserte un cassette,
 - La alimentación del DECK se activa. En la Pantalla de Visualización Multi Función se ilumina "VCR".
- 2 Presione **PLAY** para reproducir el cassette.
 - Si el cassette no tiene la lengüeta de prevención de grabación (página 6), se inicia la reproducción automáticamente.

Detalles especiales durante la grabación

- Presione **FF/SLOW+** o **REW/SLOW-** para búsqueda de escenas hacia delante/ hacia atrás. Presione **PLAY** para liberar. Durante la búsqueda, cada vez que presione **FF** o **REW** se cambia la velocidad como sigue:
 - [SLP] aprox. 21X ↔ aprox. 9X
 - [LP] aprox. 9X ↔ aprox. 7X
 - [SP] aprox. 7X ↔ aprox. 3X
 Si la imagen se interrumpe con la velocidad de 21X, 9X o 7X, cambie la velocidad a 9X, 7X o 3X.
- Presione **PAUSE/STILL** para imagen Fija (Congelada).
- Presione **PLAY** para liberar.
- Presione **PAUSE/STILL** en el modo de imagen fija para imágenes cuadro a cuadro.
- Presione **PLAY** para liberar.
- Presione **FF/SLOW+** o **REW/SLOW-** en el modo de imagen fija para cambiar la velocidad de las imágenes a cámara lenta.

- 3 Presione **STOP** para detener el cassette.
 - Presione **REW/SLOW-** o **FF/SLOW+** en el modo de parada para rebobinado/avance rápido del cassette.
 - Presione **EJECT** en el control remoto, o **STOP/EJECT** en el DECK para expulsar el cassette.

Operaciones básicas para la grabación

- 1 Inserte el cassette con lengüeta de protección de grabación (página 6).
- 2 Presione **CH ▲/▼**, o las teclas de números para seleccionar el canal.
- 3 Presione **SPEED** para seleccionar la velocidad de grabación (página 6).
 - SP = Reproducción estándar,
 - LP = Larga duración,
 - SLP = Superlarga duración.
- 4 Presione **REC** para comenzar a grabar.
 - Para eliminar escenas indeseadas, presione **PAUSE/STILL** para hacer una pausa, y al presionar nuevamente continua la grabación.
 - No podrá ver otro canal durante la grabación.

- 5 Presione **STOP** para detener la grabación.

Programación fácil para la grabación con temporizador

- 1 Presione **PROG** para visualizar la pantalla de Programación.

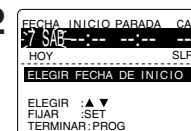

- 1) Para ajustar la **FECHA de grabación**, presione **▲/▼** para seleccionar:
 - 1-31 = una vez, o
 - DIARIO = a la misma hora de lunes a viernes, o
 - SEMANA = a la misma hora cada semana y presione **SET** para ajustar.

Orden para elegir

Ejemplo
 Fecha de hoy — 8-9.....31-1-2.....6
 ▲/▼ Orden para elegir DIARIO
 SEMANAL.....SEMANAL SEMANAL
 (SAB) (LUN) (DOM)

- 2) Para ajustar los ítems que quedan, presione **▲/▼** para seleccionar y presione **SET** para ajustar los tiempos de **INICIO/ PARADA, CANAL**, o entrada de **LINEA** (página 35), y velocidad del cassette (**SP, LP, SLP**). Presione **PROG** para finalizar **PROGRAM**.

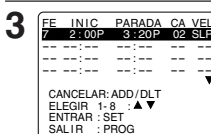

- 3 Presione **▲/▼** para seleccionar un número que no está usando para ingresar mas programas y presione **SET** para ajustar. Luego repita el paso 2.
 - Presione nuevamente **PROG** para salir.

Grabación de un toque

- Presione **REC** repetidamente para ajustar la hora de grabación (30 min - 4 horas).
- La videograbadora termina la grabación a una hora programada.

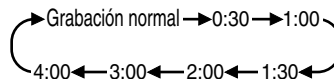

Spanish Quick Use Guide/ Guía para rápida consulta

Operaciones básicas del DVD

- 1** Presione **POWER** en el control remoto o el aparato.
- 2** Presione **DVD** para seleccionar el modo DVD.
- 3**
 - 1) Presione **OPEN/CLOSE**.
 - 2) Ponga un disco en la bandeja de disco.
 - Sujete el disco sin tocar ninguna de sus superficies, póngalo con el lado donde está impreso el título hacia arriba, alinéelo con las guías y póngalo en su posición apropiada. Disco de 3" (8 cm) / Disco de 5" (12 cm)
- 4** Presione **PLAY** para iniciar la reproducción. La bandeja del disco se cierra automáticamente.
 - Si está usando un DVD interactivo (Interactive DVD) o un Vídeo CD con control de reproducción (playback control) y aparece un menú de títulos (TITLE MENU) en la pantalla, siga al paso 5.
- 5** Presione **▲▼◀▶** o las teclas numéricas para seleccionar el artículo deseado. Presione **SET** o **PLAY** para la reproducción. Si usa las teclas numéricas, la reproducción comienza automáticamente.
- 6** Presione **STOP** para parar la reproducción.
- 7** Presione **OPEN/CLOSE** para expulsar el disco.

- **Para buscar una escena particular**
 - Búsqueda hacia adelante**
Presione **FF/SLOW+** en el modo de reproducción.
 - Búsqueda hacia atrás**
Presione **REW/SLOW-** en el modo de reproducción. (Para liberar, presione **PLAY**)
- **Para saltar un capítulo o una pista**
 - Salto hacia adelante**
Presione **SKIP ▶▶▶** en el modo de reproducción. Un capítulo (DVD) o una pista (Vídeo CD/CD) se salta cada vez que se oprime la tecla.
 - Salto hacia atrás**
Presione **◀◀◀ SKIP** en el modo de reproducción.
- **Para ver una imagen fija**
Presione **PAUSE/STILL** durante la reproducción. (Para liberar, presione **PLAY**)
- **Para ver imágenes cuadro a cuadro (DVD/Vídeo CD)**
Presione **PAUSE/STILL** en el modo de imagen fija. La imagen avanza un cuadro cada vez que presiona la tecla. (Para volver a la reproducción normal, presione **PLAY**)
- **Para ver en cámara lenta (DVD/Vídeo CD)**
Presione **FF/SLOW+** o **REW/SLOW-** en el modo de imagen fija. (Para liberar, presione **PLAY**)

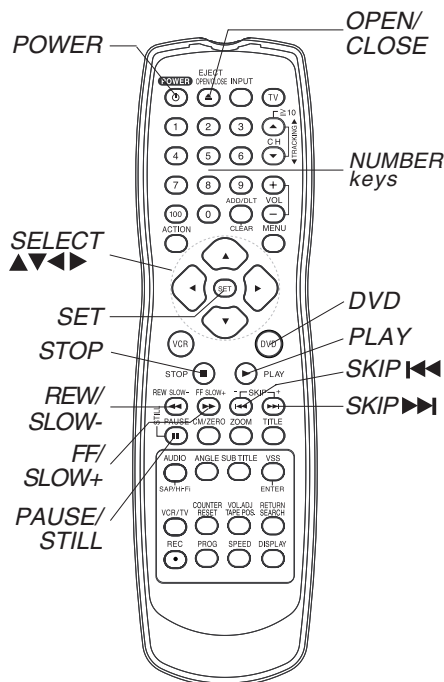

Funcionamiento del DVD utilizando visualizaciones en pantalla

Cuando se presiona DISPLAY, la visualización en pantalla muestra la información del disco (título / capítulo / número de lista, tiempo transcurrido de reproducción, audio / idioma del subtítulo, y ángulo) e información (repetir la reproducción, modo reproducción, Karaoke vocal encendido / apagado, etc.).

1 Presione **DISPLAY** en el modo reproducción o parada para visualizar las visualizaciones en pantalla.

- Cada vez que se presione **DISPLAY**, la visualización en pantalla cambia como se muestra a continuación.

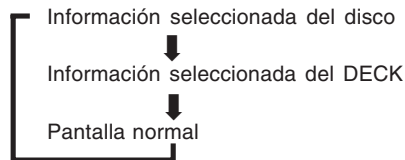

2 Presione **▲▼** (o **◀▶**) para seleccionar el ítem deseado.

Presione **SET** para ajustar.

3 Presione **▲▼** para seleccionar el ajuste deseado.

Presione **SET** para ajustar.

Para volver a la pantalla normal, Presione repetidamente **CLEAR** o **DISPLAY**.

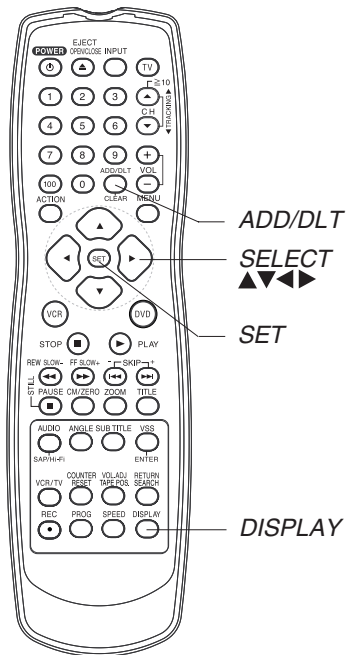

<Ejemplo (DVD)>

TÍTULO : 12	DVD
CAPÍTULO : 11	00:12:34
ELEGIR: ▲▼	
FIJAR : SET SIGUIENTE: DISPLAY	

TÍTULO : 12	DVD
CAPÍTULO : 12	00:12:34
ELEGIR: ▲▼	
FIJAR : SET SIGUIENTE: DISPLAY	

<Ejemplo (Vídeo CD)>

PISTA : 12	VIDEO CD
PBC : INACTIVO	00:12:34
ELEGIR: ▲▼	
FIJAR : SET SIGUIENTE: DISPLAY	

PISTA : 13	VIDEO CD
PBC : INACTIVO	00:12:34
ELEGIR: ▲▼	
FIJAR : SET SIGUIENTE: DISPLAY	

Guía para rápida
consulta

Spanish Quick Use Guide/ Guía para rápida consulta

Utilización de un menú de títulos [DVD solamente]

Algunos discos con películas, vienen con dos o más títulos. Por ejemplo, si el disco tiene un menú de títulos grabados, el botón TITLE podrá utilizarse para seleccionar el título de la película.

- 1 Presione **TITLE** durante la reproducción. Ahora se visualiza una lista de los títulos del disco.

- 2  Presione **▲▼◀▶** o las **teclas de números** para seleccionar el título deseado. Presione **SET** para elegir.

<ejemplo>

Utilización de un menú de DVD [DVD solamente]

Algunos discos DVD ofrecen un menú especial. Este menú incluye guías para contenidos únicos, audio, subtítulos, idiomas, etc. Aunque los contenidos y las operaciones se cambian, los siguientes son unos pasos básicos para el uso del menú.

- 1 Presione **MENU** durante la reproducción. El menú de DVD introducido en el disco se visualiza ahora.

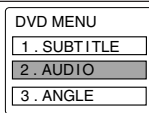
- 2  Presione **▲▼◀▶** o las **teclas de números** para seleccionar el ítem deseado. Presione **SET** para elegir.

<ejemplo>

Ampliación de la imagen [DVD solamente]

Durante la reproducción de un DVD, puede ampliar partes específicas de una imagen y seleccionar la relación de zoom usando el botón ZOOM.

Presione **ZOOM** repetidamente para cambiar el tamaño de la imagen como se indica a continuación:

- Use los botones **▲, ▼, ◀** y **▶** para desplazar la posición hacia arriba, hacia abajo, hacia la izquierda o hacia la derecha.



Funcionamiento de la ejecución de MP3/WMA/JPEG

Puede utilizar esta unidad para reproducir audio de formato MP3/WMA/JPEG, grabado para uso personal con una computadora, etc., en un CD-ROM o CD-RW. La ejecución no podrá realizarse en algunos casos, debido a las condiciones de la grabación.

- 1 Presione **POWER** en el control remoto o DECK.
- 2 Presione **OPEN/CLOSE** y a continuación coloque un disco MP3/WMA/JPEG en la bandeja de discos. Presione **OPEN/CLOSE** para cerrarla.
- 3 Se visualizará el MENU MP3/WMA/JPEG y la ejecución se iniciará automáticamente. (Se visualizará el directorio del CD.)

<ejemplo>

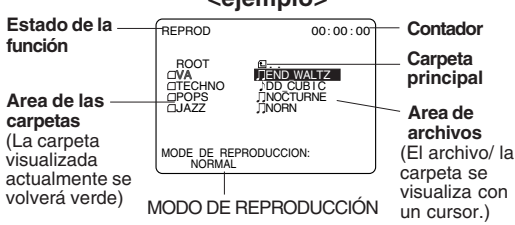

Estado de la función: REPROD 00:00:00

Contador: 00:00:00

Carpeta principal: 6. HEND WALTZ

Area de las carpetas (La carpeta visualizada actualmente se volverá verde): MODE DE REPRODUCCION: NORMAL

Area de archivos (El archivo/ la carpeta se visualiza con un cursor.): HEND WALTZ, JDD CUBTC, JNOCTURNE, JNORN

MODO DE REPRODUCCIÓN: NORMAL

Archivo MP3
 Archivo WMA
 Archivo JPEG
 Carpeta
 Carpeta principal

- 4 ■ **Ejecución MP3/WMA/JPEG** (Durante el modo STOP) Presione **▲▼** para seleccionar un archivo MP3/WMA () o un archivo JPEG () y presione **SET** o **PLAY**.
 - **MP3/WMA**
 Búsqueda hacia adelante/hacia atrás
 ⇒ Presione **FF/SLOW+** o **REW/SLOW-** durante la ejecución.
 Salto de pista hacia adelante/hacia atrás
 ⇒ Presione **SKIP▶▶▶** o **◀◀◀ SKIP** durante la ejecución.
 - **JPEG**
 Búsqueda siguiente/anterior
 ⇒ Presione **SKIP▶▶▶** o **◀◀◀ SKIP**.
 Inicie la muestra-diapositiva
 ⇒ Presione **FF/SLOW+** o **REW/SLOW-**.
 Ampliar una imagen ⇒ Presione **ZOOM**.
 Girar una imagen ⇒ Presione **ANGLE**.
 Presione **STOP** para detener la operación descrita arriba.
- **Seleccione MODO DE REPRODUCCION** (Durante el modo STOP) Presione **◀▶** para mover el cursor a MODO DE REPRODUCCION, y Presione **▲▼** para seleccionar el MODO DE REPRODUCCION deseado.

[MODO DE REPRODUCCION]

NORMAL: Todos los archivos se reproducen sólo una vez

REPETICION DE UNA MUSIC: El archivo seleccionado se reproduce repetidamente.

REPETICION DE UN ARCHIVO: Los archivos que se encuentran en la carpeta seleccionada se reproducen repetidamente.

REPETICION DEL DISCO: Todos los archivos se reproducen repetidamente.

- 5 Presione **ACTION** para regresar al DVD MENU PRINCIPAL.

60



Por ayuda llame al 1-800-211-PANA(7262) o envíe e-mail a : consumerproducts@panasonic.com

Fijaciones iniciales

- 1 Presione **DVD** para seleccionar el modo DVD.
- 2 Presione **ACTION** en el modo de parada para visualizar **MENU**.
- 3 Presione **▲▼** para seleccionar el artículo deseado.
Presione **SET**.
IDIOMAS DEL DISCO
Todos los idiomas ofrecidos en el disco pueden ser ajustados. Si el idioma ajustado no es ofrecido en el disco, se seleccionará el idioma original del disco.
SALIDA DE AUDIO
Puede usted ajustar la salida audio procedente del terminal de salida audio digital.
DETENER RASTREO
Para seleccionar "CAMPO" o "CUADRO fijo" para prevenir inestabilidad o para permitir ver textos pequeños o patrones finos claramente en el modo de imagen fija.
TV PREFERENCIA
Para seleccionar cuando el material del vídeo es para pantalla ancha y se quiere reproducir en el estilo Pan&Scan, en el estilo Letterbox o en el estilo 16 : 9 en la pantalla.
- 4 Presione **▲▼** para seleccionar el artículo deseado.
Presione **SET**.
- 5 Volver a visualizar el menú de DVD para continuar el ajuste.
Presione **ACTION** y pase al paso 3 para ajustar otro ajuste o, para salir, presione **ACTION** tres veces.

Cambio del idioma de subtítulos [DVD solamente]

El idioma de los subtítulos seleccionado al hacer las fijaciones iniciales se puede cambiar por otro idioma diferente, si éste se encuentra disponible.

- 1  Presione **SUBTITLE** durante la reproducción.
Cuando no haya subtítulos grabados, se visualizará "..." en lugar del número de idioma.
- 2  Presione **▲▼** para seleccionar el idioma deseado.
Presione **◀▶** para seleccionar "ACTIVO" o "INACTIVO."

Selección de vocal para los discos de Karaoke [DVD/Vídeo CD]

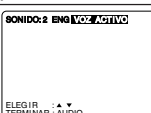
- 1 Presione **AUDIO** durante la reproducción para visualizar la pantalla **AUDIO**.
- 2  Presione **▲▼** (o **◀▶**) para seleccionar el ajuste deseado.
Presione **▲** (o **▼**) para ajustar. (DVD solamente)

- DVD Karaoke (1 vocal) VOCAL ON ↔ VOCAL OFF
- DVD Karaoke (2 vocals) VOCAL V1 ↔ VOCAL V2 ↔ VOCAL V1+V2 ↔ VOCAL OFF
- Video CD LR → L → R

Selección de IDIOMAS DEL DISCO [DVD solamente]

- Seleccione "AUDIO"**
(Fijación de fábrica : inglés)
Inglés / Español / Francés / Japonesa :
Original : Se seleccionará el idioma original de cada disco.
OTRO ** :** Se puede seleccionar el otro idioma.
- Seleccione "SUBTITULO"**
AUTO : Se seleccionará el mismo que fue seleccionado en la preparación de "AUDIO". (Fijación de fábrica)
• Si el idioma seleccionado en la preparación de "AUDIO" se utiliza durante la reproducción, los subtítulos no aparecerán.
• Si se utiliza otro idioma durante la reproducción, los subtítulos aparecerán en el idioma seleccionado en la preparación de "AUDIO"
Inglés / Español / Francés / Japonesa :
OTRO ** :** Se puede seleccionar el otro idioma.
- Seleccione "MENU"**
(Fijación de fábrica : inglés)
Inglés / Español / Francés / Japonesa :
OTRO ** :** Se puede seleccionar el otro idioma.

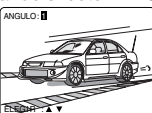

Visión desde otro ángulo [DVD solamente]

Algunos discos DVD tienen escenas que han sido filmadas simultáneamente desde un número de ángulos diferentes. Con estos discos, la misma escena podrá verse desde cada uno de estos ángulos diferentes utilizando el botón **ANGLE**.

- 1  Presione **ANGLE** durante la reproducción para visualizar la selección del ángulo.
- 2  Presione **▲▼** para seleccionar el ángulo deseado.

Cambio del idioma de la pista de sonido [DVD solamente]

El idioma de la pista de sonido seleccionado al hacer las fijaciones iniciales se puede cambiar por otro idioma diferente, si éste se encuentra disponible.

- 1  Presione **AUDIO** durante la reproducción para visualizar **SONIDO** en la pantalla.
- 2  Presione **▲▼** para seleccionar idioma.

Guía para rápida consulta

Index

DECK & VCR

- A** ACTION button 8, 18
- Accessories 4
- ADD/DELETE button
(Add or Delete a Channel) 8, 19
- Audio Broadcast types
(Stereo/SAP/Mono) 26
- Audio Mode (Playback, Recording) 27
- Auto Operation Functions 31
- Auto Shut-Off 33
- B** Batteries 4
- C** Channel ("SET UP CHANNEL") 18
- Channel Up/Down,
Tracking/V-Lock Button 6, 8
- Clock ("SET CLOCK") 18
- Commercial Skip 31
- Connections 12 ~ 15
- Copy Your Tapes (Dubbing) 35
- COUNTER RESET button 8, 32
- Customer Services Directory 55
- D** DISPLAY button 8, 11
- DST (Daylight Saving Time) 19
- E** EJECT button 8, 20
- ENTER button
(For tuning TV Channel) 8, 28
- F** FAST FORWARD/SEARCH button .. 8, 20
- H** Head Cleaning 6
- I** Index Search 30
- Indicator (Multi Function Display) 11
- Initial Setup (Ready to Play) 16, 17
- INPUT button 8, 35
- L** Limited Warranty 54, 55
- Location of Controls
(Remote, DECK) 8 ~ 10
- M** Multi-Brand Control 28, 29
- O** On-Screen Displays (VCR) 11
- One Touch Recording 21
- P** PAUSE/STILL button (Still Picture) .. 8, 20
- PLAY button (Playback a Tape) 8, 20
- POWER button 8
- PROG button (PROGRAM) 8, 24
- Program Clear, Review, Replace 25
- Program End Search 30
- Q** Quality Picture 6
- R** REC button (Record on a Tape) 8, 21
- Record Tab 6
- Remote Sensor 9
- Remote Warning 34
- Repeat Play 32
- Reset All Memory Functions 9
- REWIND/SEARCH button 8, 20
- S** SAP/Hi-Fi 27
- SEARCH
(Index and Program End Search) 30
- SLOW+/SLOW- button
(Slow Motion Picture) 8, 20
- Spanish Quick Use Guide 56 ~ 61
- Specifications 7
- SPEED button 8, 21
- Still (Freeze) Picture 20
- STOP button 8, 20
- T** Tape Position, Tape Status 34
- Timer Recording 24
- Trouble Shooting 52, 53
- TV mode button 8, 28
- V** VCR Lock 33
- VCR mode button 8, 28
- VCR/TV button 8, 21
- VCR/TV Selector Feature 32
- VOLUME +/- button (TV Volume) ... 8, 28
- W** Warning and Instruction Displays 51
- Weak Signal Display 33
- Z** ZERO SEARCH button 8, 32

DVD

- A** ACTION button 8, 47
- ANGLE button
 - (Multiple Angle Viewing) 8, 37, 45
- AUDIO button
 - (Audio Soundtrack Language) 8, 36
- Audio Output
 - (For Selecting Audio Output) 48
- Auto-Power Off Function 23
- C** CLEAR button 8, 39, 46
- Component Video Output 10, 13
- D** Disc Languages 47
- DISPLAY button
 - (“On-Screen Display”) 8, 41
- DTS 14
- DVD Menu 38
- DVD mode button 8, 28
- DVD Lock Ratings 46
- F** Frame by Frame Picture 23
- Forward/Reverse Chapter/Track Skip ... 23
- Forward/Reverse Scene Search 23
- J** JPEG 43 ~ 45
- K** Karaoke
 - (Vocal Selection for Karaoke Discs) 37
- L** Language Code List 50
- M**MENU button
 - (To display DVD Menu) 8, 38
- MP3 43
- Multiple Angle Viewing 37
- O** OPEN/CLOSE button 8, 22
- Optical Digital Audio Output 10, 15
- P** PLAY button (Play a Disc) 8, 22
- Program Play (For Video CD/ CD) 39
- PROGRESSIVE button 9
- Progressive Scan 10
- R** Random Play (For Video CD/ CD) 40
- Repeat Play 42
- Resume Function 23
- RETURN button 8, 22
- Rotation 45
- S** SEARCH button
 - (Forward/Reverse Scene Search) .. 8, 23
- SKIP ►► or ◀◀ button
 - (Forward/Reverse Chapter/Track) .. 8, 23
- Slide-show 44
- SLOW+/SLOW- button
 - (Slow Motion Picture) 8, 23
- STILL button
 - (Still Picture or Pause) 8, 23
- Still Mode
 - (For selecting “FIELD” or “FRAME”) 49
- STOP button 8, 22
- SUB TITLE button
 - (For selecting Subtitle Language) .. 8, 36
- S-Video Out 10, 13
- T** TITLE button (Title Menu) 8, 38
- TV Mode
 - (For selecting the screen display style) 49
- V** Video CD 23
- VOLUME ADJUST button 8, 40
- V.S.S. (Virtual Surround Sound) 8, 23
- WWMA 43
- Z** ZOOM button (Picture Zoom) 8, 37, 45

**For Your
Information**

Panasonic Consumer Electronics Company,
Division of Matsushita Electric Corporation of America
One Panasonic Way Secaucus, New Jersey 07094
Panasonic Sales Company ("PSC"),
Division of Matsushita Electric of Puerto Rico, Inc.
Ave. 65 de Infantería. Km. 9.5 San Gabriel Industrial Park, Carolina,
Puerto Rico 00985



Printed in Indonesia
LSQT0674C
S0103-2063