

Panasonic

DVD Home Theater Sound System

Operating Instructions

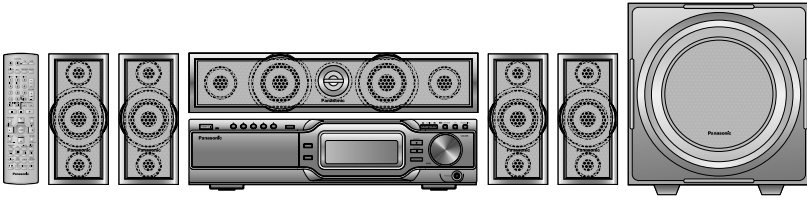

Model No. **SC-HT670**

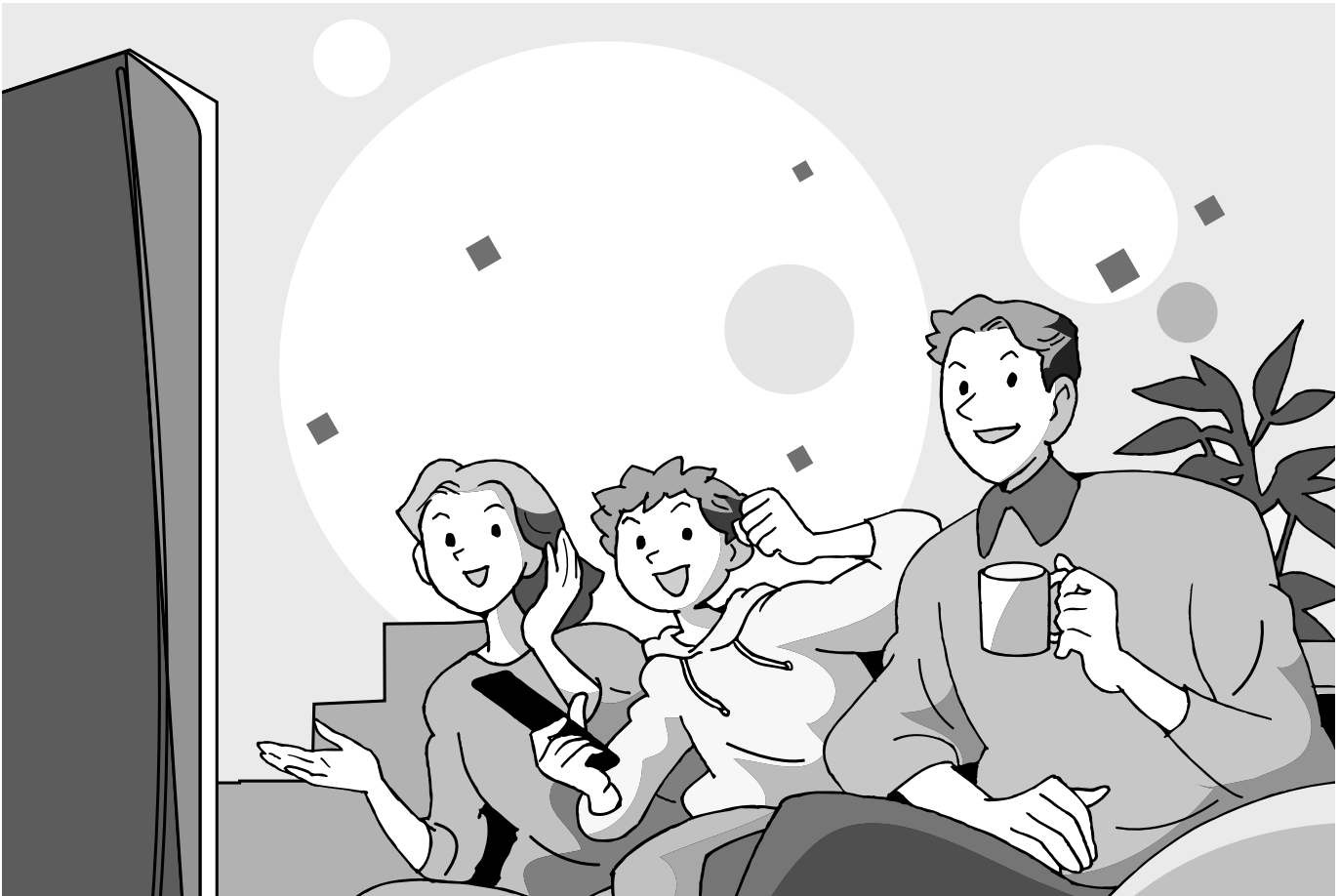

Before connecting, operating or adjusting this product, please read these instructions completely. Please keep this manual for future reference.



Region number supported by this player

Region numbers are allocated to DVD players and software according to where they are sold.

- The region number of this player is "1".

Example:

- The player will play DVD-Video marked with labels containing "1" or "ALL".



As an ENERGY STAR® Partner*, Panasonic has determined that this product meets the ENERGY STAR® guidelines for energy efficiency.

* For Canada only: The word "Participant" is used in place of the word "Partner".

For U.S.A. only

The warranty can be found on page 35.

Dear customer

Thank you for purchasing this product.
For optimum performance and safety, please read these instructions carefully.

Getting started

System	SC-HT670
Main unit	SA-HT670
Front and Surround speakers	SB-FS670
Center speaker	SB-PC670
Subwoofer	SB-W670

Operations in these instructions are described mainly for the remote control, but you can perform the operations on the main unit if the controls are the same.

CAUTION!
THIS PRODUCT UTILIZES A LASER.
USE OF CONTROLS OR ADJUSTMENTS OR PERFORMANCE OF PROCEDURES OTHER THAN THOSE SPECIFIED HEREIN MAY RESULT IN HAZARDOUS RADIATION EXPOSURE.
DO NOT OPEN COVERS AND DO NOT REPAIR YOURSELF. REFER SERVICING TO QUALIFIED PERSONNEL.

WARNING:
TO REDUCE THE RISK OF FIRE, ELECTRIC SHOCK OR PRODUCT DAMAGE, DO NOT EXPOSE THIS APPARATUS TO RAIN, MOISTURE, DRIPPING OR SPLASHING AND THAT NO OBJECTS FILLED WITH LIQUIDS, SUCH AS VASES, SHALL BE PLACED ON THE APPARATUS.

CAUTION!
DO NOT INSTALL OR PLACE THIS UNIT IN A BOOKCASE, BUILT-IN CABINET OR IN ANOTHER CONFINED SPACE. ENSURE THE UNIT IS WELL VENTILATED. TO PREVENT RISK OF ELECTRIC SHOCK OR FIRE HAZARD DUE TO OVERHEATING, ENSURE THAT CURTAINS AND ANY OTHER MATERIALS DO NOT OBSTRUCT THE VENTILATION VENTS.

CAUTION

**RISK OF ELECTRIC SHOCK
DO NOT OPEN**

CAUTION: TO REDUCE THE RISK OF ELECTRIC SHOCK, DO NOT REMOVE SCREWS. NO USER-SERVICEABLE PARTS INSIDE. REFER SERVICING TO QUALIFIED SERVICE PERSONNEL.

The lightning flash with arrowhead symbol, within an equilateral triangle, is intended to alert the user to the presence of uninsulated "dangerous voltage" within the product's enclosure that may be of sufficient magnitude to constitute a risk of electric shock to persons.

The exclamation point within an equilateral triangle is intended to alert the user to the presence of important operating and maintenance (servicing) instructions in the literature accompanying the appliance.

THE FOLLOWING APPLIES ONLY IN THE U.S.A.:

CAUTION:
This equipment has been tested and found to comply with the limits for a Class B digital device, pursuant to Part 15 of the FCC Rules.
These limits are designed to provide reasonable protection against harmful interference in a residential installation. This equipment generates, uses and can radiate radio frequency energy and, if not installed and used in accordance with the instructions, may cause harmful interference to radio communications. However, there is no guarantee that interference will not occur in a particular installation. If this equipment does cause harmful interference to radio or television reception, which can be determined by turning the equipment off and on, the user is encouraged to try to correct the interference by one or more of the following measures:

- Reorient or relocate the receiving antenna.
- Increase the separation between the equipment and receiver.
- Connect the equipment into an outlet on a circuit different from that to which the receiver is connected.
- Consult the dealer or an experienced radio/TV technician for help.

Any unauthorized changes or modifications to this equipment would void the user's authority to operate this device.

This device complies with Part 15 of the FCC Rules. Operation is subject to the following two conditions: (1) This device may not cause harmful interference, and (2) this device must accept any interference received, including interference that may cause undesired operation.

CAUTION	- LASER RADIATION WHEN OPEN. DO NOT STARE INTO BEAM. FDA 21 CFR / Class II
CAUTION	- VISIBLE AND INVISIBLE LASER RADIATION WHEN OPEN. AVOID EXPOSURE TO BEAM. EC60825-1 / Class 3b
VARNING	- SYNLIIG OCH OSYNLIIG LASERSTRÅLNING NÄR DENNA DEL ÄR ÖPPNAD. BETRÄKTA EJ STRÅLEN.
ADVARSEL	- SYNLIIG OG USYNLIIG LASERSTRÅLING VED ÅBNING. UNDGA UDSÆTTELSE FOR STRÅLING.
ADVARSEL	- SYNLIIG OG USYNLIIG LASERSTRÅLING NÄR DEKSEL ÄR ÖPPNAD. UNDGA EXPOSITION FÖR STRÅLEN.
VARO!	- AVATTAESSA OLET ALTIIN NÄKYVÄÄ JA NÄKYMÄTÖN LASERSÄTELVÄLLE. ÄLÄ KATSO SÄTEESEEN.
VORSICHT	- SICHTBARE UND UNSICHTBARE LASERSTRÄHLUNG, WENN ABDECKUNG GEÖFFNET. NICHT DEM STRAHL AUSSETZEN.
ATTENTION	- RAYONNEMENT LASER VISIBLE ET INVISIBLE EN CAS D'OUVERTURE. EXPOSITION DANGEREUSE AU FAISCEAU.
注意	- 打开時可见及不可见激光辐射。避免激光直射。
注意	- ここを開くと可視及び不可視レーザー光が出ます。ビームを見たり、触れたりしないで下さい。 RQLXS0054

(Inside of product)

Accessories

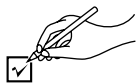

Please check and identify the supplied accessories. Use numbers indicated in parentheses when asking for replacement parts.

In U.S.A. to order accessories, refer to "Accessory Purchases" on page 35.

- 1 Remote control**
(EUR7722X70)

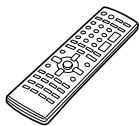

- 1 AM loop antenna**
(N1DAAA00001)



- 2 Batteries**
for remote control



- 1 FM indoor antenna**
(RSA0007-J)



- 1 AC power supply cord**
(RJA0065-A)

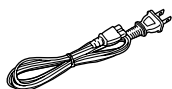

- 5 Speaker cables**
3×4-m (13-foot) cables
(REE1247A)
2×10-m (33-foot) cables
(REE1247C)



- 1 Video cable**
(RJL1P016B15A)



- 2 Sheets of speaker-cable stickers**

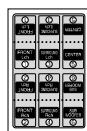

- 1 Antenna plug**
(K2RC021B0001)



Note

The included AC power supply cord is for use with this unit only. Do not use it with other equipment.

Table of contents

Getting started

Accessories	3
IMPORTANT SAFETY INSTRUCTIONS	4
Disc information	5
Simple setup	
STEP1 Positioning	6
STEP2 Speakers	6
STEP3 Television	7
STEP4 Antennas and AC power supply cord	7
STEP5 The remote control	8
Other speaker setup options	8
STEP6 QUICK SETUP	9

Control reference guide	10
-------------------------------	----

Radio operations

The radio	11
Manual tuning/Preset tuning	11

Disc operations

Discs—Basic play	12
Sequential play (CD Mode)	12
Changing the disc/Checking the disc trays	13
Position Memory function	13
Replaying a scene—QUICK REPLAY	13
Starting play from a selected item	13
Selecting still pictures—Page skip	13
Skipping items/Fast forward and rewind—SEARCH	13
Slow-motion play/Frame-by-frame viewing	13
Discs—Convenient functions	14
Selecting groups to play/Repeat play/A-B repeat play	14
Audio	14
Subtitles	15
Playmode functions	15
Marking places to play again/Zoom function	16
Playing the programs or play lists on DVD-RAM	17
Selecting a program to play—DIRECT NAVIGATOR	17
Using the play list menu	17
WMA/MP3, JPEG and CD text navigation menus	18
Playing HighMAT discs	19
Using On-Screen Menus	20
Common procedures/Progress indicator	20
Changing play speed	20
Main Menu/Other Settings	21

Sound field/sound quality operations

Sound field	23
Dolby Digital and DTS/Dolby Pro Logic II	23
Speaker level adjustments	23
Super Surround/Sound Field Control/Center Focus	24
Custom Sound Memory—Store the sound settings	24
Sound quality	25
Adjusting the subwoofer level	25
Multi Re-master—Enjoying more natural sound	25

Other functions

Convenient functions	25
Muting the volume	25
Changing the unit's display	25
The sleep timer/Using headphones	25
Operating other equipment	26
Changing settings	28
Optional antenna connections	30

Reference

Glossary	31
Specifications	32
Troubleshooting guide	33
Limited Warranty (ONLY FOR U.S.A.)	35
Product Service	Back page
Maintenance	Back page

IMPORTANT SAFETY INSTRUCTIONS

Read these operating instructions carefully before using the unit. Follow the safety instructions on the unit and the applicable safety instructions listed below. Keep these operating instructions handy for future reference.

- 1) Read these instructions.
- 2) Keep these instructions.
- 3) Heed all warnings.
- 4) Follow all instructions.
- 5) Do not use this apparatus near water.
- 6) Clean only with dry cloth.
- 7) Do not block any ventilation openings. Install in accordance with the manufacturer's instructions.
- 8) Do not install near any heat sources such as radiators, heat registers, stoves, or other apparatus (including amplifiers) that produce heat.
- 9) Do not defeat the safety purpose of the polarized or grounding-type plug. A polarized plug has two blades with one wider than the other. A grounding-type plug has two blades and a third grounding prong. The wide blade or the third prong are provided for your safety. If the provided plug does not fit into your outlet, consult an electrician for replacement of the obsolete outlet.
- 10) Protect the power cord from being walked on or pinched particularly at plugs, convenience receptacles, and the point where they exit from the apparatus.
- 11) Only use attachments/accessories specified by the manufacturer.
- 12) Use only with the cart, stand, tripod, bracket, or table specified by the manufacturer, or sold with the apparatus. When a cart is used, use caution when moving the cart/apparatus combination to avoid injury from tip-over.
- 13) Unplug this apparatus during lightning storms or when unused for long periods of time.
- 14) Refer all servicing to qualified service personnel. Servicing is required when the apparatus has been damaged in any way, such as power-supply cord or plug is damaged, liquid has been spilled or objects have fallen into the apparatus, the apparatus has been exposed to rain or moisture, does not operate normally, or has been dropped.



Listening caution



Selecting fine audio equipment such as the unit you've just purchased is only the start of your musical enjoyment. Now it's time to consider how you can maximize the fun and excitement your equipment offers. This manufacturer and the Electronic Industries Association's Consumer Electronics Group want you to get the most out of your equipment by playing it at a safe level. One that lets the sound come through loud and clear without annoying blaring or distortion—and, most importantly, without affecting your sensitive hearing.

We recommend that you avoid prolonged exposure to excessive noise.

Sound can be deceiving. Over time your hearing "comfort level" adapts to higher volumes of sound. So what sounds "normal" can actually be loud and harmful to your hearing.

Guard against this by setting your equipment at a safe level BEFORE your hearing adapts.

To establish a safe level:

- Start your volume control at a low setting.
- Slowly increase the sound until you can hear it comfortably and clearly, and without distortion.







Once you have established a comfortable sound level:

- Set the dial and leave it there.

Taking a minute to do this now will help to prevent hearing damage or loss in the future. After all, we want you listening for a lifetime.

Disc information

■ Discs that can be played

Disc	Logo	Indication in these operating instructions	Remarks
DVD-RAM		RAM	Recorded using Version 1.1 of the Video Recording Format (a unified video recording standard). <ul style="list-style-type: none"> Recorded with DVD-Video recorders, DVD-Video cameras, personal computers, etc. Remove discs from their cartridges before use.
		JPEG	Recorded using the DCF (Design rule for Camera File system) standard. <ul style="list-style-type: none"> Recorded with Panasonic DVD-Video recorders. To play JPEG files, select "Play as Data Disc" in Other Menu (➔ page 22).
DVD-Audio		DVD-A	—
		DVD-V	Some DVD-Audio discs contain DVD-Video content. To play DVD-Video content, select "Play as DVD-Video" in Other Menu (➔ page 22).
DVD-Video		DVD-V	—
DVD-R			Panasonic DVD-R recorded and finalized* on Panasonic DVD-Video recorders or DVD-Video cameras are played as DVD-Video on this unit.
Video CD		VCD	—
SVCD			Conforming to IEC62107
CD		CD	This unit is compatible with HDCD. HDCD-encoded CDs sound better because they are encoded with 20 bits, as compared with 16 bits for all other CDs. <ul style="list-style-type: none"> During HDCD play, "HDCD" lights up on the unit's display.
CD-R CD-RW	—	WMA MP3 JPEG CD VCD	<ul style="list-style-type: none"> This unit can play CD-R/RW (audio recording disc) recorded with the formats on the left. Close the session or finalize* the disc after recording. HighMAT discs WMA, MP3 or JPEG files only. To play without using the HighMAT function, select "Play as Data Disc" in Other Menu (➔ page 22).

* A process that allows play on compatible equipment.

● It may not be possible to play the above discs in all cases due to the type of disc or condition of the recording.

■ Discs that cannot be played

DVD-ROM, CD-ROM, CDV, CD-G, DVD+R, +RW, DVD-RW, SACD, Divx Video Discs and Photo CD, DVD-RAM that cannot be removed from their cartridges, 2.6-GB and 5.2-GB DVD-RAM and "Chaoji VCD" available on the market including CVD, DVCD and SVCD that do not conform to IEC62107.

Playing DVDs and Video CDs

The producer of these discs can control how they are played so you may not always be able to control play as described in these operating instructions (for example if the play time is not displayed or if a Video CD has menus). Read the disc's instructions carefully.

■ Inserting a disc correctly

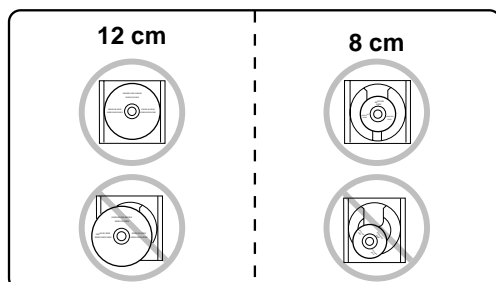

- Insert the disc correctly into position as indicated in the diagrams above.
- Place only one disc on a tray.
- Insert the disc with the label side facing up.

■ Playing PAL system DVD-Audio

This unit converts PAL to NTSC for play. The picture is compressed to show it in its entirety, but this may cause it to be stretched vertically.

■ To clean discs

DVD-A **DVD-V** **VCD** **CD**

Wipe with a damp cloth and then wipe dry.



RAM **DVD-R**

- Clean with an optional DVD-RAM/PD disc cleaner (LF-K200DCA1, where available).
- Never use cloths or cleaners for CDs, etc.

■ Handling precautions

- Do not write on the label side with a ball-point pen or other writing instrument.
- Do not use record cleaning sprays, benzene, thinner, static electricity prevention liquids or any other solvent.
- Do not attach labels or stickers to discs. (Do not use discs with exposed adhesive from tape or left over peeled-off stickers.)
- Do not use scratch-proof protectors or covers.
- Do not use discs printed with label printers available on the market.
- Do not use irregularly shaped discs (e.g. heart-shaped), as these can damage the unit.
- Do not use discs that are badly warped or cracked.

Simple setup

STEP 1 Positioning

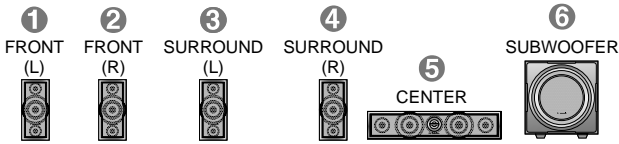

Setup example

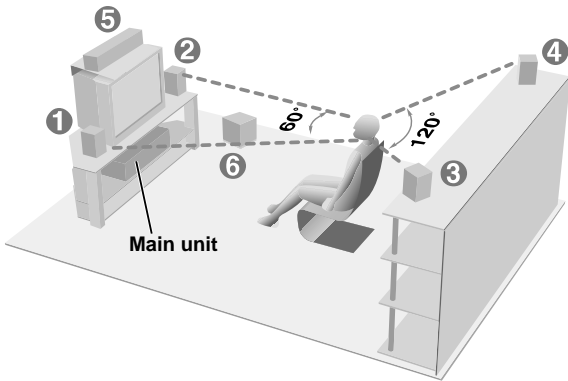

- The front and surround speakers are the same. Use those you have connected the short cords to as front speakers and those you have connected the long cords to as surround speakers.
- Place the front, center, and surround speakers at approximately the same distance from the seating position. The angles in the diagram are approximate.

Use only supplied speakers

Using other speakers can damage the unit and sound quality will be negatively affected.

- Set the speakers up on an even surface to prevent them from falling. Take proper precautions to prevent the speakers from falling if you cannot set them up on an even surface.

Positioning for best effect

How you set up your speakers can affect the bass and the sound field. Note the following points.

- Place speakers on flat secure bases.
- Placing speakers too close to floors, walls, and corners can result in excessive bass. Cover walls and windows with thick curtain.

Main unit

Note

Keep your speakers at least 10 mm ($\frac{13}{32}$ ") away from the system for proper ventilation.

Center speaker

- You can also put this speaker directly under the television.
- Vibration caused by the center speaker can disrupt the picture if it is placed directly on the television. Put the center speaker on a rack or shelf.

Subwoofer

Place to the right or left of the television, on the floor or a sturdy shelf so that it won't cause vibration.

Leave 10 cm (4") at the rear for ventilation.

STEP 2 Speakers

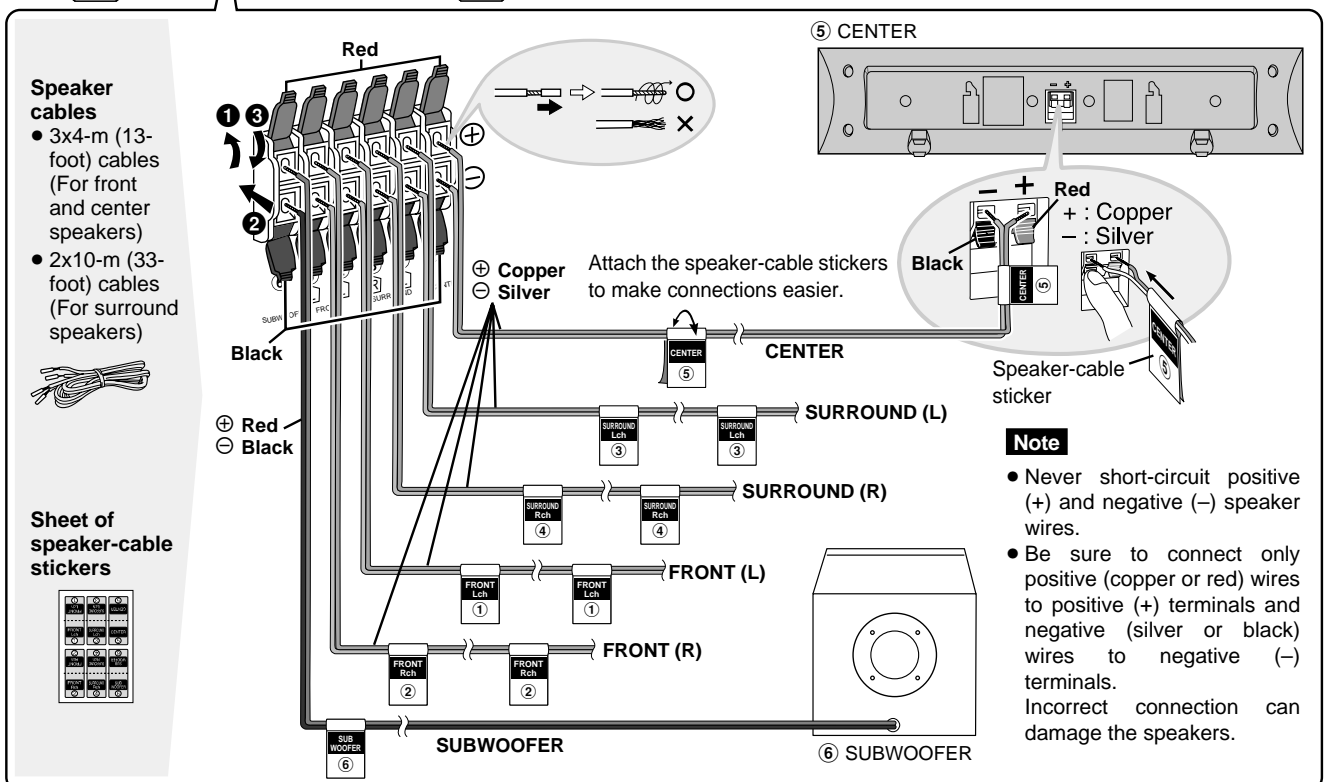
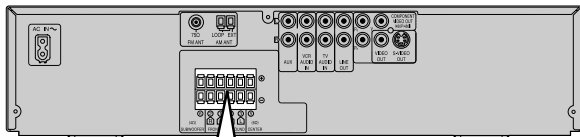

STEP 3 Television

■ Connecting a television with a VIDEO IN terminal

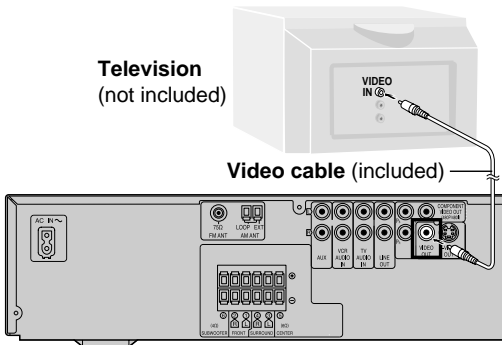

Connect directly to your television.

Do not connect the unit through a video cassette recorder, because the picture may not be played correctly due to the copy guard.

■ Connecting a television with an S-VIDEO IN terminal

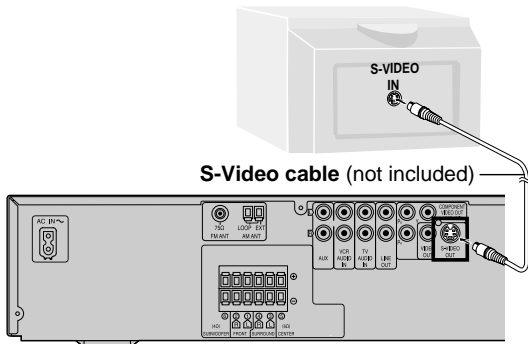

S-VIDEO OUT terminal

The S-VIDEO OUT terminal achieves a more vivid picture than the VIDEO OUT terminal by separating the chrominance (C) and luminance (Y) signals. (Actual results depend on the television.)

Video cable



■ Connecting a television with COMPONENT VIDEO IN terminals

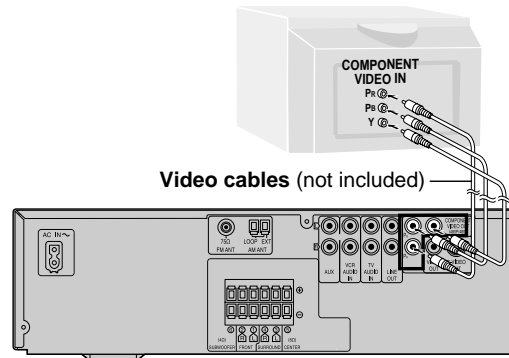

COMPONENT VIDEO OUT terminals

These terminals can be used for either interlace or progressive output and provide a purer picture than the S-VIDEO OUT terminal. Connection using these terminals outputs the color difference signals (P_B/P_R) and luminance signal (Y) separately in order to achieve high fidelity in reproducing colors.

- The description of the component video input terminals depends on the television or monitor (e.g. Y/P_B/P_R, Y/B-Y/R-Y, Y/C_B/C_R). Connect to terminals of the same color.
- After making this connection, change the black level for a better picture (→ page 28, Video – Black Level Control).

To enjoy progressive video

- Connect to the component video (480P) input terminals on a television compatible with this unit's copy guard system. (Video will not be displayed correctly if connected to an incompatible television.)
- Press [PROGRESSIVE] on the main unit so "PROG." appears on the display (→ page 12).
- All televisions manufactured by Panasonic and that have 480P input connectors are compatible. Consult the manufacturer if you have another brand of television.

STEP 4 Antennas and AC power supply cord

- Connect the AC power supply cord after all other connections are complete.
- Optional antenna connections (→ page 30).

AM loop antenna



FM indoor antenna



AC power supply cord

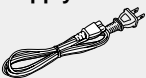

FM indoor antenna
Adhesive tape
Fix the other end of the antenna where reception is best.

CLICK!

AM loop antenna

Stand the antenna up on its base. Place the antenna where the reception is best. Keep loose antenna cord away from other wires and cords.

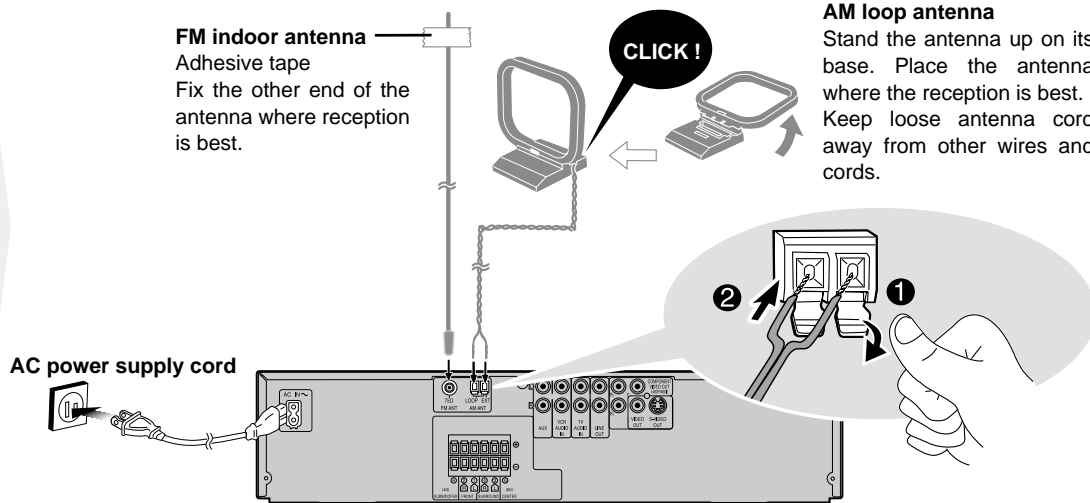

Conserving power

The unit consumes power (approx. 0.5 W) even when it is turned off with [⏻]. To save power when the unit will not be used for a long time, unplug it from the household AC outlet.

You will need to reset some memory items after plugging in the unit.

STEP 5 The remote control

Remote control



Batteries

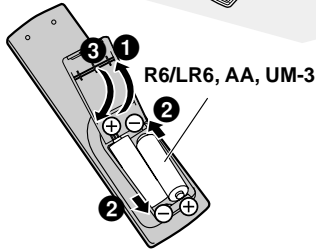

R6/LR6, AA, UM-3

- Insert so the poles (+ and -) match those in the remote control.
- Do not use rechargeable type batteries.

Other speaker setup options

Attaching to a wall

Note

The wall or pillar on which the speakers are to be attached should be capable of supporting 5 kg (11 lb.) per screw.

1 Screw a screw (not included) into the wall.

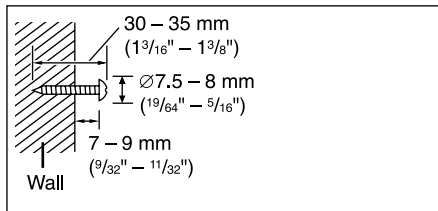

2 Fit the speaker securely onto the screw with the hole or holes.

Front/Surround speaker

Center speaker

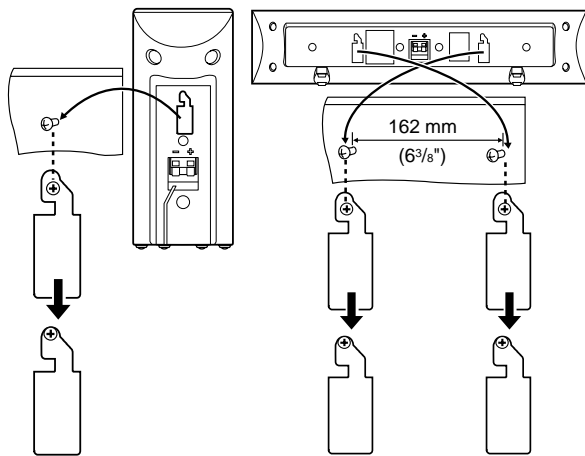

Do not;

- mix old and new batteries.
 - use different types at the same time.
 - heat or expose to flame.
 - take apart or short circuit.
 - attempt to recharge alkaline or manganese batteries.
 - use batteries if the covering has been peeled off.
- Mishandling of batteries can cause electrolyte leakage which can damage items the fluid contacts and may cause a fire.

Remove if the remote control is not going to be used for a long period of time. Store in a cool, dark place.

■ Use

Aim at the sensor, avoiding obstacles, at a maximum range of 7 m (23 feet) directly in front of the unit.

Fitting speaker stands (optional)

Preparation

Ensure the stands meet these conditions before purchasing them.

- Observe the diameter and length of the screws and the distance between screws as shown in the diagram.
- The stands must be able to support over 5 kg (11 lb.).
- The stands must be stable even if the speakers are in a high position.

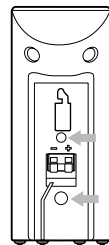

Attach the stands with these holes.

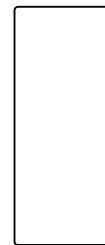

Plate thickness plus 7 to 10 mm (plus 9/32" to 13/32")

5 mm (1/8"), pitch 0.8 mm (1/32")

Speaker stand (not included)

Notes on speaker use

- You can damage your speakers and shorten their useful life if you play sound at high levels over extended periods.
- Reduce the volume in the following cases to avoid damage.
 - When playing distorted sound.
 - When the speakers are receiving howling from a record player, noise from FM broadcasts, or continuous signals from an oscillator, test disc, or electronic instrument.
 - When adjusting the sound quality.
 - When turning the unit on or off.

If irregular coloring occurs on your television

These speakers are designed to be used close to a television, but the picture may be affected with some televisions and setup combinations.

If this occurs, turn the television off for about 30 minutes.

The television's demagnetizing function should correct the problem. If it persists, move the speakers further away from the television.



Caution

- Use the speakers only with the recommended system. Failure to do so may lead to damage to the amplifier and/or the speakers, and may result in the risk of fire. Consult a qualified service person if damage has occurred or if you experience a sudden change in performance.
- Do not attempt to attach these speakers to walls using methods other than those described in this manual.

STEP 6 QUICK SETUP

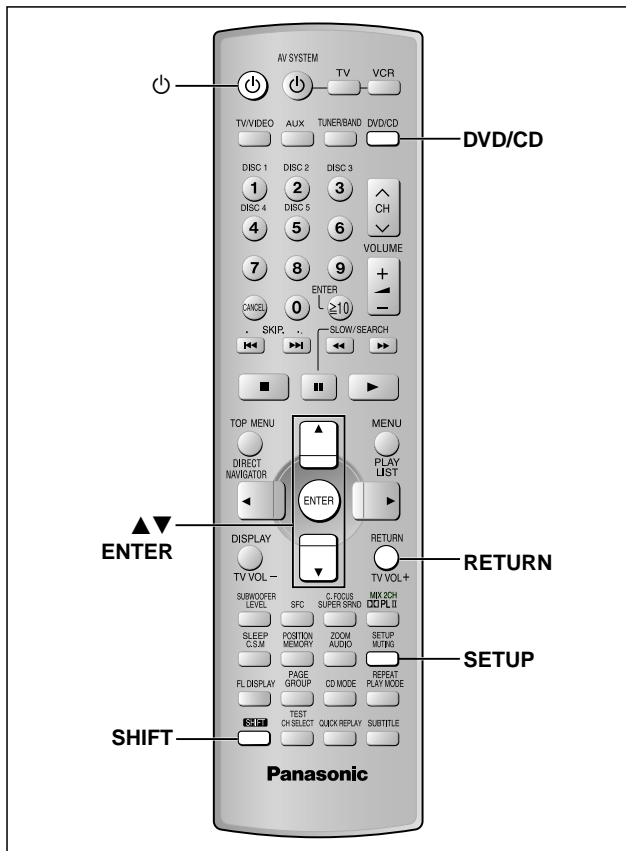

The **QUICK SETUP** screen appears when you press [SHIFT]+[SETUP] the first time after purchase and assists you to make necessary settings. You can access this screen again later if you need to (⇒ page 28, Others — QUICK SETUP).

Preparation

Turn on the television and select the appropriate video input on the television to suit the connections for the unit.

- 1 Press [POWER] to turn on the unit.
- 2 Press [DVD/CD] to select “DVD/CD” as the source.
- 3 Press [SHIFT]+[SETUP] to show the QUICK SETUP screen.

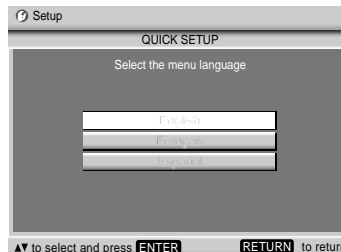

- 4 Press [▲, ▼] to select the menu language and press [ENTER].
- 5 Press [▲, ▼] to select “Yes” to continue and press [ENTER].
- 6 Press [▲, ▼] to select the item and press [ENTER].
 - TV Type (⇒ below)
 - TV Aspect (⇒ below)
- 7 Press [ENTER] and then [SHIFT]+[SETUP] to exit the settings.

To return to the previous screen

Press [RETURN].

■ TV Type

Select to suit the type of television.

- Standard (Direct View TV) (factory preset)
- CRT Projector
- LCD TV/Projector
- Projection TV
- Plasma TV

■ TV Aspect

Select “4:3” (regular) or “16:9” (widescreen) to suit your television. If you have a regular 4:3 television, you can also select how video on some discs is shown (⇒ page 28, Video – TV Aspect).

- 4:3 Pan&Scan (factory preset)

Widescreen software expands the picture to fill the screen of a 4:3 aspect television (unless prohibited by the producer of the disc).



- 4:3 Letterbox

Widescreen software shows the picture in letterbox style on a 4:3 aspect television.



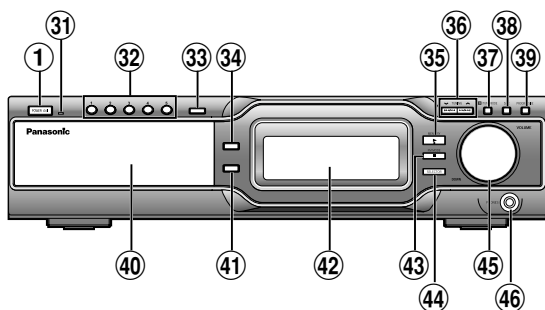
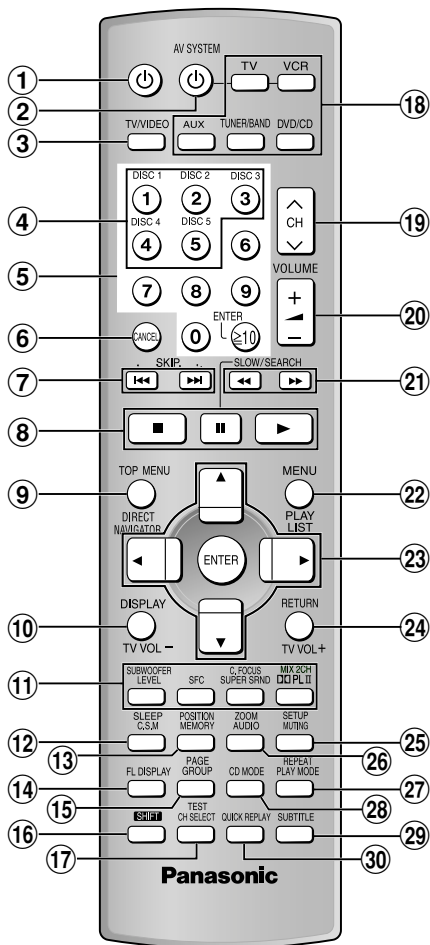

Remote control

- ① Standby/on switch [⏻] 9
- ② AV system standby/on button [⏻, AV SYSTEM] 27
- ③ TV/VIDEO button [TV/VIDEO] 27
- ④ Disc buttons [DISC 1]–[DISC 5] 12
- ⑤ Numbered buttons [1–9, 0, ≡/10/ENTER] 11
- ⑥ Cancel button [CANCEL] 15, 16, 29
- ⑦ Skip buttons [◀◀ ▶▶, SKIP] 13
- ⑧ Basic operation buttons 12
- ⑨ Top menu, Direct navigator button [TOP MENU, DIRECT NAVIGATOR] 12, 17
- ⑩ Display, TV volume down button [DISPLAY, TV VOL –] 14, 19, 27
- ⑪ Sound field, sound quality buttons 23–25
- ⑫ Custom sound memory, Sleep button [C.S.M, SLEEP] 24, 25
- ⑬ Position memory button [POSITION MEMORY] 13
- ⑭ FL display [FL DISPLAY] 25
- ⑮ Group, Page button [GROUP, PAGE] 13–15
- ⑯ Shift button [SHIFT]
- To use functions labeled in orange:
While pressing [SHIFT], press the corresponding button.
- ⑰ Channel select, Test button [CH SELECT, TEST] 23
- ⑱ Source select buttons
Face towards this unit to change the source.
Press [TV] or [VCR] first to operate a Panasonic television or video cassette recorder (→ page 27)
- ⑲ Preset channel, TV channel button [▲ CH ▼] 11, 27
- ⑳ Volume buttons [+ , – , VOLUME] 11, 23
- ㉑ Slow/search, Fast-forward/rewind, Tuning buttons [◀◀ ▶▶, SLOW/SEARCH] 11, 13, 27
- ㉒ Menu, Play list button [MENU, PLAY LIST] 12, 17, 18
- ㉓ Cursor buttons [▲, ▼, ◀, ▶], Enter button [ENTER] 9
- ㉔ Return, TV volume up button [RETURN, TV VOL +] 9, 27
- ㉕ Muting, Setup button [MUTING, SETUP] 9, 25
- ㉖ Audio, Zoom button [AUDIO, ZOOM] 14, 16
- ㉗ Play mode, Repeat button [PLAY MODE, REPEAT] 14, 15
- ㉘ CD mode button [CD MODE] 12
- ㉙ Subtitle button [SUBTITLE] 15
- ㉚ Quick replay button [QUICK REPLAY] 13, 14

Main unit

- ① Standby/on switch [POWER ⏻/I] 9
Press to switch the unit from on to standby mode or vice versa. In standby mode, the unit is still consuming a small amount of power.
- ⑳ AC supply indicator [AC IN]
This indicator lights when the unit is connected to the AC mains supply.
- ㉑ Disc buttons and indicators [DISC 1]–[DISC 5] 13
- ㉒ Disc check button [DISC CHECK] 13
- ㉓ Drawer open/close button [OPEN/CLOSE ▲] 12
- ㉔ Play, Memory button [▶, MEMORY] 11, 12
- ㉕ Skip/search, Tuning buttons [◀◀/▶▶, ◀▶/▶▶, ▼ TUNING ▲] 11, 13
- ㉖ CD/Tune mode button [CD/TUNE MODE] 11, 12
- ㉗ Sound field control button [SFC] 24
- ㉘ Progressive out button [PROGRESSIVE] 12
- ㉙ Drawer
- ㉚ Disc change button [DISC CHANGE ▲] 13
- ㉛ Display
- ㉜ Stop, FM mode button [■, FM MODE] 11, 12, 15, 19
- ㉝ Source select button [SELECTOR]
DVD/CD→FM→AM→TV→VCR→AUX
- ㉞ Volume control [VOLUME, DOWN, UP] 11
- ㉟ Headphone jack [PHONES] 25

The radio

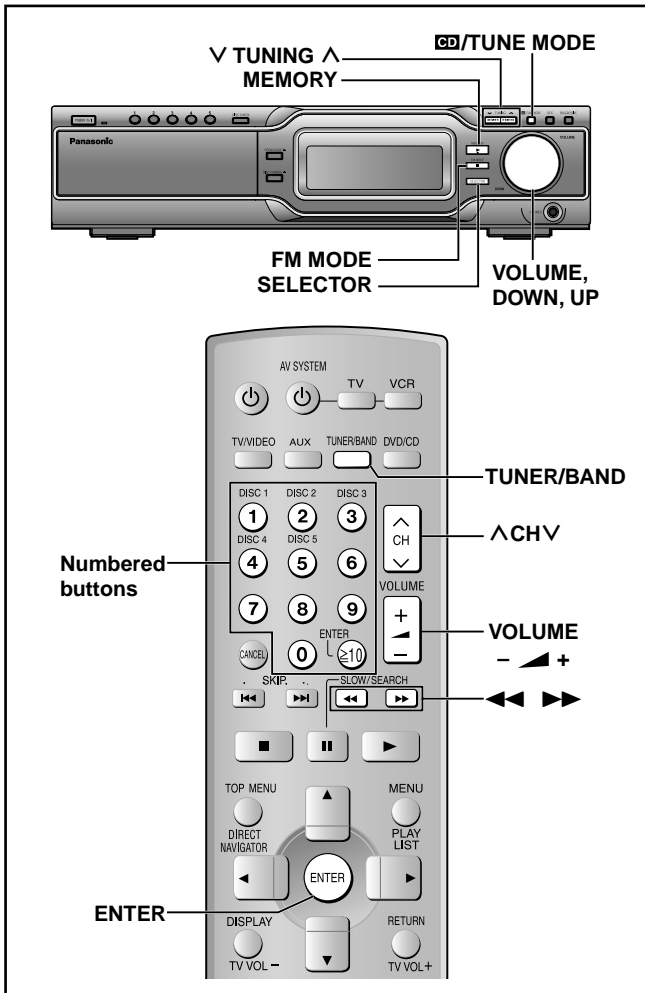

FM frequency settings

You can change the FM step. The step is factory-set to 0.2 MHz, but you can change it to receive broadcasts allocated 0.1 MHz steps.

1 Press [TUNER/BAND] to select "FM".

2 Press and hold [SELECTOR] on the main unit.

After a few seconds the display changes to show the current minimum frequency. Continue to hold the button down. The minimum frequency changes and the step is changed.

To return to the original step, repeat the above steps.

Note

Any FM/AM frequencies preset in channels will be changed by this procedure. Preset them again.

Preset tuning

There are two methods of pre-setting stations.

Automatic presetting: All the stations the tuner can receive are preset.

Manual presetting: You can select the stations to preset and the order they are preset in.

Up to 15 stations can be set in each, the FM and AM bands.

Automatic presetting

Do the following once

For each, FM and AM.

Tune to the frequency where pre-setting is to begin.

Press and hold [ENTER] until the frequency changes.

• Main unit: Press and hold [MEMORY].

The tuner presets all the stations it can receive into the channels in ascending order.

"SET OK" is displayed when the stations are set. The last station to be set is then played.

"ERROR" is displayed

Presetting was unsuccessful. Preset manually.

Manual presetting

1 Tune to the station (→ see left: "Manual tuning").

2 Press [ENTER].

3 While "PGM" is flashing

Press the numbered buttons to select a channel.

Alternatively, press [^ CH v] then press [ENTER].

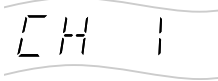

The station occupying a channel is erased if another station is preset in that channel.

Selecting channels

1 Press [TUNER/BAND] to select "FM" or "AM".

2 Press the numbered buttons or [^ CH v] to select the channel.

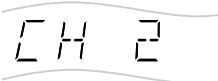

To select a 2-digit number

Example: To select channel 12, press [≥10] → [1] → [2]

Manual tuning

1 Press [SELECTOR] to select "FM" or "AM".

Each time you press the button:

DVD/CD → FM → AM → TV → VCR → AUX

• Remote control: Press [TUNER/BAND].

2 Press [CD/TUNE MODE] to select "MANUAL".

Each time you press the button: MANUAL ↔ PRESET

3 Press [V TUNING] or [TUNING ^] to select the frequency of the required station.

• Remote control: Press [◀] or [▶].

TUNED: Displayed when a radio station is tuned.

ST: Displayed when a stereo FM broadcast is being received.

Press and hold [V TUNING] or [TUNING ^] until the frequency starts scrolling to start automatic tuning. Tuning stops when a station is found.

4 Adjust the volume.

If noise is excessive in FM

Press [FM MODE] to display "MONO".

Press [FM MODE] again to cancel the mode.

The mode is also canceled when you change the frequency.

Discs—Basic play

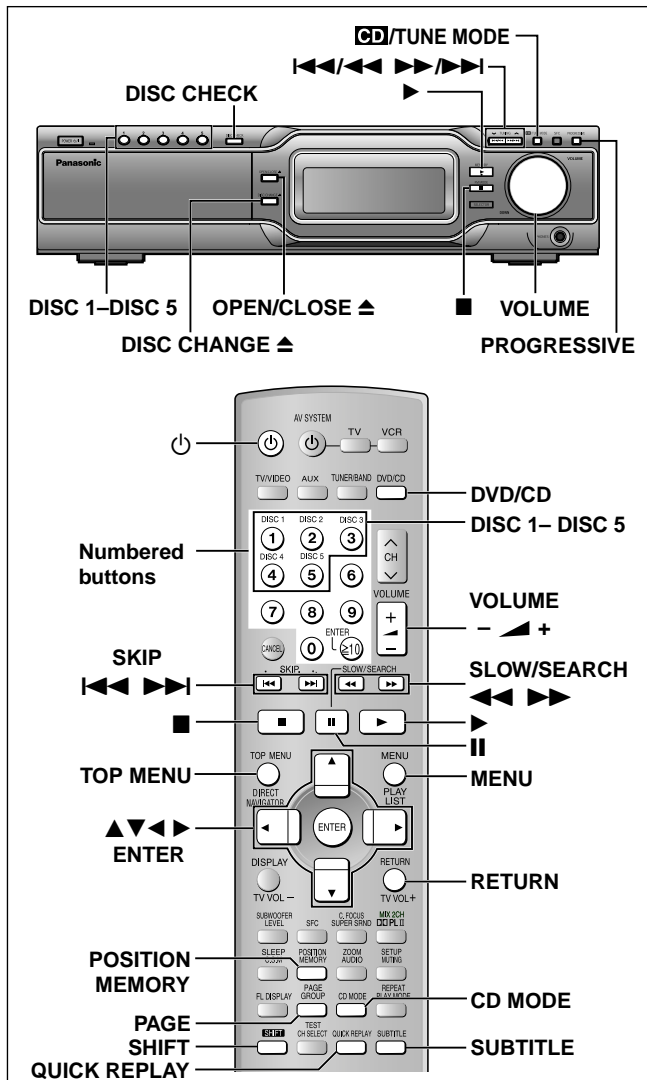

RAM DVD-A DVD-V VCD CD WMA MP3 JPEG

Preparation

- Press [⏻] to turn on the unit.
- Turn on the television and select the appropriate video input on the television to suit the connections for the unit.

1 Press [DVD/CD] to select "DVD/CD" as the source.

To enjoy progressive video Press [PROGRESSIVE].

The television will be disrupted for a moment but this is normal.

- Output from this unit is interlace if you have connected to the television through the VIDEO OUT or S-VIDEO OUT or are playing PAL discs, even if "PROG." is on the display.
- When progressive output is on, closed captions will not be displayed.



2 Press [OPEN/CLOSE ▲] to open the drawer and place a disc on the disc tray.

To load discs onto the other trays, refer to "Changing the disc". (→ page 13)

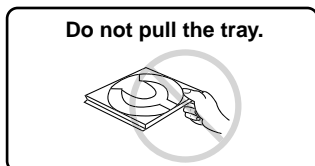

If the disc contains both audio data (WMA and MP3) and JPEG, press [TOP MENU] to select "All" (JPEG/WMA/MP3), "Audio" (WMA/MP3) or "Picture" (JPEG) in the Playback Menu.

- Remove TYPE 2 and 4 discs from their cartridges before use. **RAM**
- Label-up (With double-sided discs, load so the label for the side you want to play is facing up.)

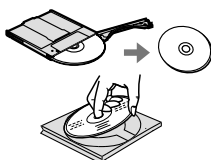

3 Press [OPEN/CLOSE ▲] to close the drawer.

The disc indicator lights orange to show the tray is in the play position.

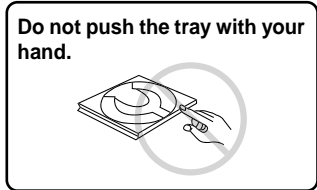

4 Press [▶] (play).

Play begins.

WMA MP3 JPEG CD (CD text only)

- Press [SUBTITLE] to turn the display on or off.
- You can also use the navigation menus to control play (→ page 18).

5 Adjust the volume.

■ To pause play

Press [⏸] during play.

Press [▶] (play) to restart play.

■ To stop play

Press [■] (→ page 13, Resume function).

■ To select a disc

Press [SHIFT] + disc button ([DISC 1]-[DISC 5]).

■ To prevent damage

Do not;

- load more than one disc per tray.
- close the drawer by hand.

Note

- If "⊘" appears on the television

The operation is prohibited by the unit or disc.

- It may take some time for play to start but this is normal.

When a menu appears on the television

DVD-A DVD-V VCD

Press the numbered buttons to select an item.

To select a 2-digit number

Example: To select item 23, press [≧10] → [2] → [3].

- When playing DVDs, you can also use [▲, ▼, ◀, ▶] to select items. Press [ENTER] to confirm your selection.

To return to the menu screen

DVD-A DVD-V [TOP MENU]: Shows the first menu screen.

DVD-V [MENU]: Shows the menu screen.

VCD [RETURN]: Shows the menu screen.

Note

The disc continues to rotate while the menu is displayed even after you finish playing an item. Press [■] when you finish to preserve the unit's motor and your television screen.

Sequential play (CD Mode)

VCD CD WMA MP3

The unit usually plays the disc in the play position and then stops.

Turn CD Mode on to play all loaded discs, except for DVDs and JPEG discs.

While stopped

Press [CD] /TUNE MODE].

- Remote control: Press [CD MODE].

Each time you press the button:

CD (on) ↔ **CD** (off)



Note

- HighMAT menus and video CD playback control are disabled.
- Only audio tracks can be played on HighMAT discs.
- You cannot change the mode during play.
- CD Mode turns off when you switch the unit to standby.

Changing the disc

RAM DVD-A DVD-V VCD CD WMA MP3 JPEG

You can change the other discs without interrupting play.

Main unit only

1 Press [DISC CHANGE ▲].

2 Within about 10 seconds

Press [DISC 1] – [DISC 5] to open the tray and change the disc.

Press [DISC CHANGE ▲] again to close the tray.

Repeat steps 1 and 2 to change other discs. You can load up to 5 discs.

Checking the disc trays

RAM DVD-A DVD-V VCD CD WMA MP3 JPEG

You can check whether a 12 cm disc is in a tray without interrupting play.

Main unit only

Press [DISC CHECK].

If the player is stopped, all trays will open.

If a disc is being played, the corresponding tray will not open.

Press [DISC CHECK] again to close the trays.

- Do not remove or insert discs during a disc check.
- Do not pull out the trays during a disc check.

Position Memory function

RAM DVD-A DVD-V VCD CD WMA MP3 (Only when the elapsed play time can be displayed.)

JPEG: Works with all JPEG content.

During play

Press [POSITION MEMORY] to memorize a position.

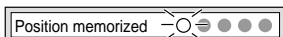

Press again to replace the position.

This position is saved even if you turn the unit off, change the source or change discs. When you turn the unit on, reselect "DVD/CD" or reinsert the disc whose position you memorized, "RESUME" lights on the display. Press [▶] (play) to start play from the memorized position. The position is cleared.

- After changing the source or selecting another disc, re-selecting the disc tray with the memorized position automatically starts playback.
- You can memorize positions on up to five different discs at a time. When you memorize another position, the earliest position is replaced.
- You cannot recall the position in CD Mode.

Resume function

"RESUME" lights on the display when the unit has recorded the position at which you stopped play.

Press [▶] (play) to start play from that position.

- The position is cleared when you:
 - Turn the unit off.
 - Select another source or change discs.
- Press [■] to clear the position.

Chapter Preview

DVD-V

The following message appears immediately after you press [▶] (play) when "RESUME" is displayed.

Press [▶] (play) while the message is displayed and the beginning portions of each chapter up to the current one are played.

Full play resumes from the point where you pressed [■] or [POSITION MEMORY].

(This feature works only within a title.)

If you do not press [▶] (play), the message disappears and play starts from where you pressed [■] or [POSITION MEMORY].

Press PLAY to preview chapters

Replaying a scene—QUICK REPLAY

(Only when the elapsed play time can be displayed)

RAM DVD-A DVD-V VCD CD WMA MP3

Skip back a few seconds.

During play

Press [QUICK REPLAY].

Note

This feature may not work while playing some parts of a disc or at all with some discs.

Starting play from a selected item

RAM DVD-A DVD-V VCD CD WMA MP3 JPEG

Press the numbered buttons to select the item.

Play starts from the selected item.

To select a 2-digit number

Example: To select item 23, press [≥10] → [2] → [3].

WMA MP3 JPEG [2] → [3] → [ENTER].

Note

- This works only when stopped with some discs.
- When playing DVD-Audio and you want to start play from a track in a different group, select the group first (→ page 14).

Selecting still pictures—Page skip

DVD-A

During play or while paused

Press [SHIFT]+[PAGE].

PAGE 1

The page changes each time you press the button.

- Press [RETURN] to go back to page 1.

Skipping items

RAM DVD-A DVD-V VCD CD WMA MP3 JPEG

During play or while paused

Press [◀◀] or [▶▶] on the remote control.

- Press [◀◀/◀◀] or [▶▶/▶▶] on the main unit.

WMA MP3 JPEG

Press [▲] or [▼] for group skip.

- Each press increases the number of skips.

Example RAM

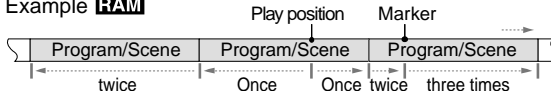

Fast forward and rewind—SEARCH

RAM DVD-A DVD-V VCD CD WMA MP3

During play

Press [◀◀] or [▶▶].

- Press and hold [◀◀/◀◀] or [▶▶/▶▶] on the main unit.
- Audio will be heard during search for most discs. You can turn this audio off if you want to (→ page 28, Audio—Audio during Search).
- DVD-V You can slow down or speed up play (→ page 20).

Slow-motion play

RAM DVD-V VCD

DVD-A (Motion picture parts only)

While paused

Press [◀◀] or [▶▶].

- Press and hold [◀◀/◀◀] or [▶▶/▶▶] on the main unit.

Frame-by-frame viewing

RAM DVD-V VCD

DVD-A (Motion picture parts only)

While paused

Press [◀] or [▶].

The frame changes each time you press the button.

- The frames change in succession if you press and hold the button.
- Pressing [■] also activates forward frame-by-frame.

Notes

- The speed of search and slow-motion increases up to 5 steps.
- Press [▶] (play) to restart play.
- You cannot move backwards with Video CD during frame-by-frame and slow-motion.

When playing Video CDs with playback control

Pressing buttons to perform skip, search or slow-motion may take you to a menu screen.

Discs—Convenient functions

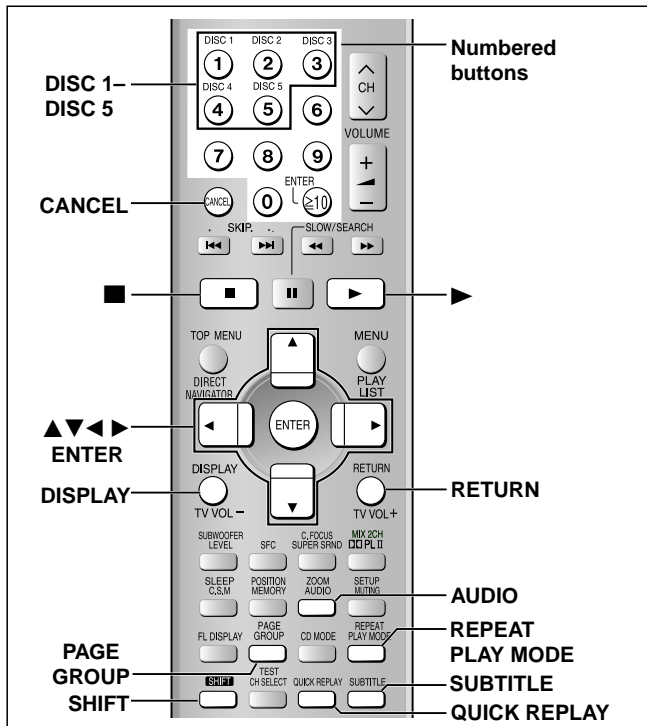

Selecting groups to play

DVD-A **WMA** **MP3** **JPEG**

1 Press [GROUP].

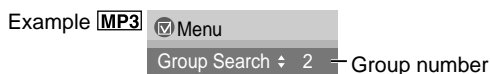

2 Press the numbered buttons to select the group and press [ENTER].

DVD-A

- Playing all the groups in succession (⇒ Page 15, All group play)
- Playing bonus groups
Some discs contain bonus groups. If a password screen appears after selecting a group, enter the password with the numbered buttons. Refer also to the disc's jacket.

Repeat play

RAM **DVD-A** **DVD-V** **VCD** **CD** **WMA** **MP3** (Only when the elapsed play time can be displayed.)

JPEG: Works with all JPEG content.

During play

Press [SHIFT]+[REPEAT].

Each time you press the button:

RAM
PG REPEAT → ALL REPEAT (Entire disc) → REPEAT OFF

- During play list play
SCENE REPEAT → PL REPEAT → REPEAT OFF

DVD-V

CHAPTER REPEAT → TITLE REPEAT* → REPEAT OFF

VCD **CD** (There is no on-screen display.)

TRACK REPEAT → ALL REPEAT (Entire disc) → REPEAT OFF

DVD-A

TRACK REPEAT → GROUP REPEAT* → REPEAT OFF

WMA **MP3** (There is no on-screen display.)

CONTENT REPEAT → GROUP REPEAT* → REPEAT OFF

JPEG (There is no on-screen display.)

GROUP REPEAT* → REPEAT OFF

* During all group (**DVD-A**), program and random play

"ALL REPEAT" is displayed.

- You can also repeat play of content and group on HighMAT discs.
- When CD Mode is on, you can only select "ALL RPT" (All Repeat) and "RPT OFF" (Repeat Off).

To repeat only your favorite tracks/chapters

Start program play (⇒ page 15) and press [SHIFT]+[REPEAT] to select the repeat mode.

A-B repeat play

(Only when the elapsed play time can be displayed.)

RAM (Except still picture part)

DVD-A **DVD-V** **VCD** **CD** **WMA** **MP3**

You can repeat a section between points A and B within a program, title or track/content.

1 During play

Press [DISPLAY] (⇒ page 21).

2 Press [▲, ▼] to select "Other Settings" and press [ENTER].

3 Press [▲, ▼] to select "Play Menu" and press [ENTER].

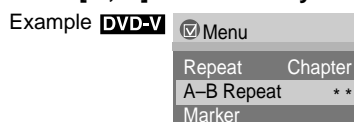

4 Press [▲, ▼] to select "A-B Repeat" and

① Press [ENTER] at the starting point (A).

② Press [ENTER] at the finishing point (B).

A-B repeat starts.

To return to normal play

Press [ENTER] again.

To clear the menus

Press [RETURN] until the menus disappear.

Note

A-B repeat is canceled when you press [QUICK REPLAY].

Audio

"_" , "_-" or "- - -" is displayed instead of the language number in circumstances such as when no language is recorded on the disc.

VCD (SVCD only)

Soundtrack and subtitle numbers may change even if corresponding soundtracks are not recorded.

DVD-A **DVD-V** (Discs with multiple soundtracks)

RAM **VCD**

During play

Press [AUDIO].

The number changes each time you press the button.

Example



DVD-V Menu Signal type/data (⇒ below)

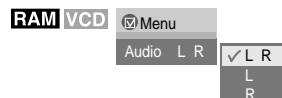
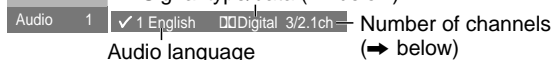

- You can also use this button to turn the vocals on and off on karaoke discs. Read the disc's instructions for details.

DVD-A

- Play restarts from the beginning of the soundtrack when changing soundtracks that are accompanied by still pictures.

- Even if a second soundtrack isn't recorded, two soundtrack numbers will normally be shown when you press [AUDIO]. The soundtrack currently playing is number 1.

Signal type/data

LPCM/PPCM/Digital/DTS: Signal type

(kHz): Sampling frequency

(bit): Number of bits

(ch): Number of channels

Example:

3/2 .1ch

.1: Low frequency effect (not displayed if there is no signal)
0: No surround
1: Mono surround
2: Stereo surround (left/right)
1: Center
2: Front left+Front right
3: Front left+Front right+Center

Subtitles

DVD-A (Motion picture parts only)

DVD-V (with multiple subtitles) **VCD** (SVCD only)

You can change the subtitle language and turn the subtitles on and off.

RAM

You can turn the subtitles on and off.

During play

Press **[SUBTITLE]** several times to select the subtitle language.

Example **DVD-V**



- In some cases, the subtitle language is not changed to the selected one immediately.

To clear/display the subtitles

1. Press **[SUBTITLE]**.
2. Press **[◀, ▶]** to select "Off" or "On".

■ **Changing the position and brightness of the subtitles** (→ page 22)

Playmode functions

DVD-A **DVD-V** **VCD** **CD** **WMA** **MP3** **JPEG**

Common procedures for all group, program and random play
While stopped

Press **[PLAY MODE]**.

Each time you press the button:

DVD-A **DVD-V** **WMA** **MP3** **JPEG**

All group (**DVD-A**) → Program → Random → off (Normal play)

VCD **CD** (There is no on-screen display.)

(PGM) → 1-DISC(RND) → ALL-DISC (RND) → off (Normal play)

DVD-A

If you select bonus groups, you will have to enter a password (→ page 14).

All group play

DVD-A

The unit plays tracks from all the groups on a disc.

Press **[▶]** (play).

Program play

You can select up to 24 items to play in the order you choose.

VCD **CD** (There is no on-screen display.)

You can program all the items on all discs.

DVD-A **DVD-V** **WMA** **MP3** **JPEG**

You can program all the items on a disc in the play position.

Example **DVD-V**

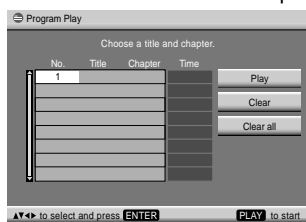

- 1 **VCD** **CD**
Press **[SHIFT] + disc button ([DISC 1]–[DISC 5])** to select disc.
- 2 Press the numbered buttons to select the items (**WMA** **MP3** **JPEG**) then press **[ENTER]**.

Example **CD**

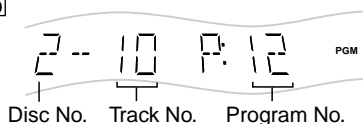

- **To select a 2-digit number**

Example: To select item 25, press **[≥10] → [2] → [5]**.

WMA **MP3** **JPEG** **[2] → [5] → [ENTER]**

- Repeat this step to program other items.
- **VCD** **CD**
Step 1 is unnecessary when programming tracks on the same disc.
- **DVD-A** **DVD-V** **WMA** **MP3** **JPEG**
To select an item using the cursor buttons
Press **[ENTER]** and **[▲, ▼]** to select an item, then press **[ENTER]** again to register the number.
All the items on the disc, title or group are selected when you select "ALL".

3 Press **[▶]** (play).

To add or change the program

VCD **CD** (Add only)

Repeat steps 1 and 2.

DVD-A **DVD-V** **WMA** **MP3** **JPEG**

- Press **[▲, ▼]** to select an available item, then repeat step 2.
- Press **[SHIFT]+[PAGE]** to skip 8 lines at a time.

To clear an item

VCD **CD**

Press **[CANCEL]**.

DVD-A **DVD-V** **WMA** **MP3** **JPEG**

1. Select the item you want to clear with **[▲, ▼]**.
2. Press **[CANCEL]**, or select "Clear" with **[▲, ▼, ◀, ▶]** and press **[ENTER]**.

To clear the whole program

VCD **CD**

Press **[■]** so "CLEAR" is displayed.

DVD-A **DVD-V** **WMA** **MP3** **JPEG**

Select "Clear all" with **[▲, ▼, ◀, ▶]** and press **[ENTER]**.

Note

- **DVD-V** **WMA** **MP3**
Times are not displayed while programming.
 - **VCD** **CD**
Items the unit cannot find can be programmed but are canceled during play. This is also the case if you program DVD-RAM, DVD-Audio, DVD-Video, WMA, MP3 and JPEG.
 - The program is cleared when you switch the unit to standby, select another source, exit the program mode by pressing **[PLAY MODE]** or move the disc out of the play position.
- VCD** **CD**
The program is retained in memory.

Random play

VCD **CD** (There is no on-screen display.)

1-DISC (RND): You can play all items on a disc in random order.

ALL-DISC (RND): You can play all items on all discs in random order.

DVD-A **DVD-V** **WMA** **MP3** **JPEG**

You can play selected item(s) on a disc in the play position in random order.

1 **DVD-A** **DVD-V** **WMA** **MP3** **JPEG**

Press the numbered buttons to select a group (**WMA** **MP3** **JPEG**) then press **[ENTER]** or a title.

Example **DVD-V**



DVD-A

- You can select more than one group.
- To enter all groups, select "All" using **[◀, ▶]** and press **[ENTER]**.
- To deselect a group, press the numbered buttons corresponding to the group you want to clear.

2 Press **[▶]** (play).

Note

- During random play, empty trays are skipped and the playback control function on Video CDs is canceled.
- During random play, this unit can access up to 999 audio/picture contents.

Note

Disable HighMAT disc play to use random and program play.

In the **SETUP** menu, set "HighMAT" to "Disable" (→ page 28) and perform the necessary operations (→ above).

To exit all group, program and random mode

Press **[PLAY MODE]** several times while stopped.

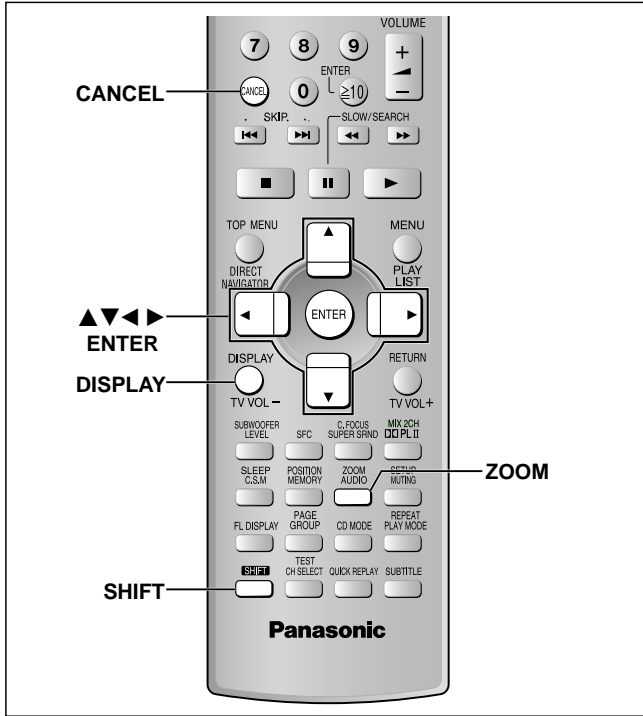

Marking places to play again

DVD-A **DVD-V** **VCD** **CD** **WMA** **MP3** (Only when the elapsed play time can be displayed)

JPEG

You can mark a position so you can return to it easily at a later time.

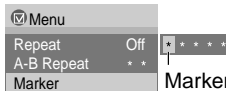
- 1 **During play**
Press **[DISPLAY]** (⇒ page 21).
- 2 Press **[▲, ▼]** to select “Other Settings” and press **[ENTER]**.
- 3 Press **[▲, ▼]** to select “Play Menu” and press **[ENTER]**.
Example **DVD-V** 
- 4 Press **[▲, ▼]** to select “Marker” and press **[ENTER]**.
- 5 Press **[ENTER]** at the point you want to mark.

To mark another position

Up to 5 points

- 1 Press **[▶]** to select “*”.
- 2 Press **[ENTER]** at the point.

To recall or erase a marker

- 1 Press **[◀, ▶]** to select a marker.
- 2 Press **[ENTER]** to recall or press **[CANCEL]** to erase.

Note

Markers added with this unit clear when you switch the unit to standby, change the source, or change the disc.

Zoom function

RAM **DVD-V** **VCD**

DVD-A (Motion picture parts only)

Change the zoom ratio so the picture expands to the optimum size to fill the screen.

Preparation

Change the setting “TV Aspect” to suit your television (⇒ page 28).

During play

Press **[SHIFT]+[ZOOM]** to select the aspect ratio.



Each time you press the button:

Auto → **4:3 Standard** → **European Vista** → **16:9 Standard**

↑ **Cinemascope2** ← **Cinemascope1** ← **American Vista** ↓

- Refer to the disc’s instructions and “Screen size” below for the aspect ratio of the picture.

To restore the original ratio

Press **[SHIFT]+[ZOOM]** until the ratio returns to 1.00.

- The ratio also returns to 1.00 when you change the disc, change the source or switch the unit to standby.
- The ratio may return to 1.00 when a menu is displayed.

Making fine adjustments (Manual Zoom) to the zoom ratio

Press **[◀, ▶]**.

- From x1.00 to x1.60 (in 0.01 units).
- From x1.60 to x2.00 (in 0.02 units).
- Press and hold **[◀, ▶]** to alter faster.

Screen size

Movies are made using a variety of screen sizes.

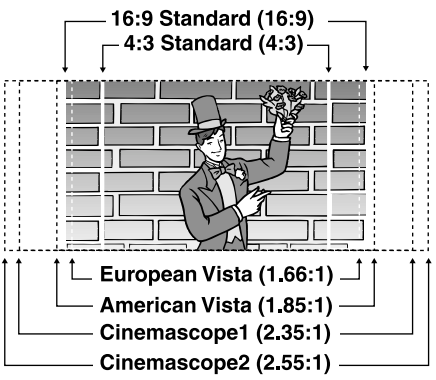

Playing the programs or play lists on DVD-RAM

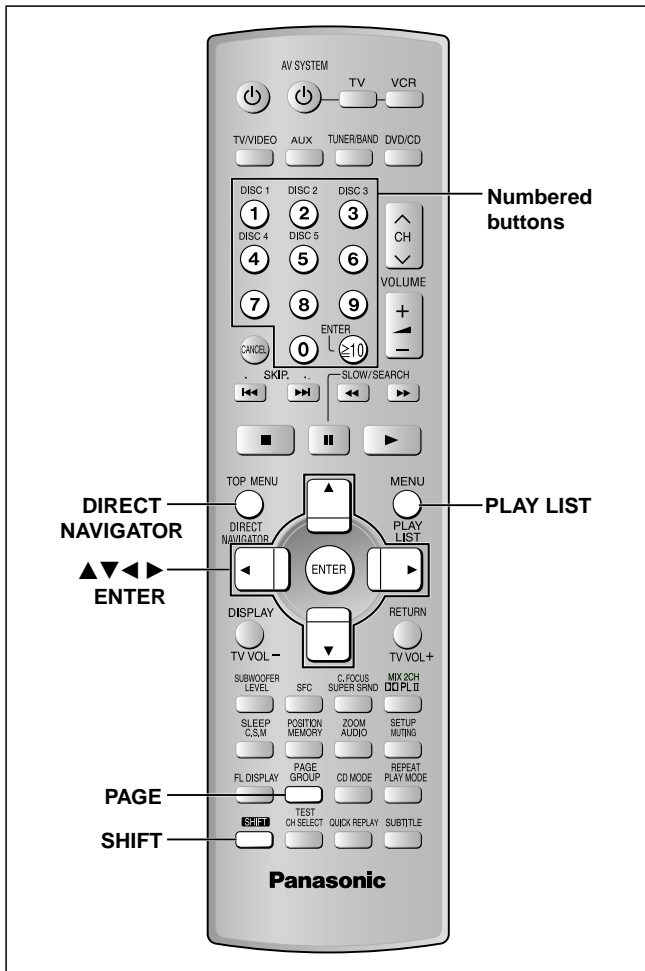

Using the play list menu

(Only when the disc contains a play list)
You can play a group of scenes, a play list, created on other equipment such as a DVD video recorder.

1 Press [PLAY LIST].



2 Press [▲, ▼] to select the play list.

- Press [SHIFT]+[PAGE] to skip 10 lines at a time.
- You can select play lists with the numbered buttons.

To select a 2-digit number

Example 23: [≧10] → [2] → [3]

3 Press [ENTER] to start play.

To clear the play list screen

Press [PLAY LIST].

RAM

Selecting a program to play — DIRECT NAVIGATOR

Use the program list to find programs to play.

1 Press [DIRECT NAVIGATOR].



2 Press [▲, ▼] to select the program.

The selected program plays in the background.

- Press [SHIFT]+[PAGE] to skip 5 lines at a time.
- You can select programs with the numbered buttons.

To select a 2-digit number

Example 23: [≧10] → [2] → [3]

- Press [▶] to show the contents of the program and disc.

3 Press [ENTER].

The program being played in the background continues.

To clear the program list

Press [DIRECT NAVIGATOR].

Note

- Titles appear only if you have entered them.
- You cannot change program and disc titles.

WMA/MP3, JPEG and CD text navigation menus

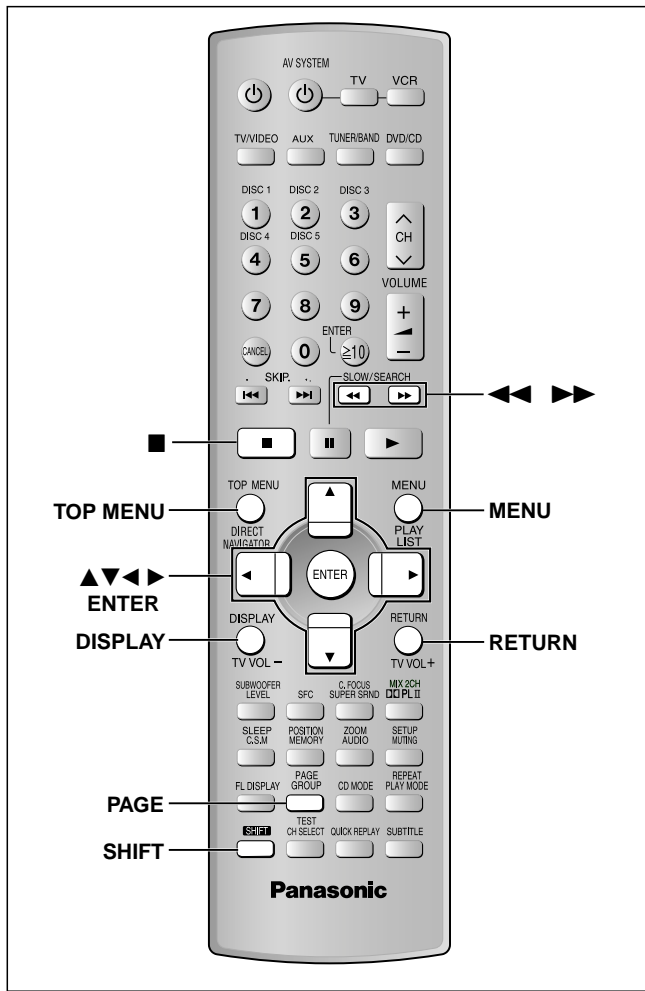

If the disc contains both audio data (WMA and MP3) and JPEG, press [TOP MENU] to select "All" (JPEG/WMA/MP3), "Audio" (WMA/MP3) or "Picture" (JPEG) in the Playback Menu.

WMA|MP3|JPEG|CD (CD text only)

Various menus help you find items you want to start play.

- 1 Press [MENU].
- 2 Press [▲, ▼, ◀, ▶] to select a content and press [ENTER].
 - After listing all the contents in one group, the list for the next group appears.

Example:

WMA|MP3|JPEG Navigation menu

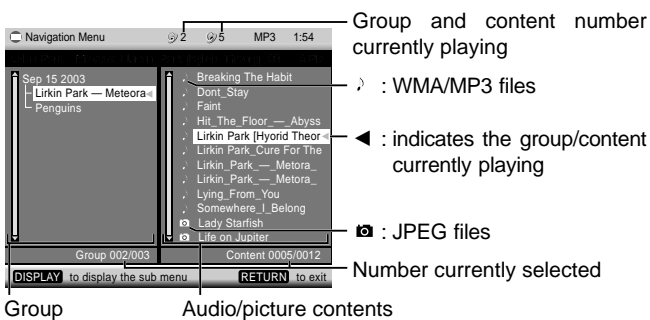

To exit

Press [RETURN].

Using the submenu WMA|MP3|JPEG

- 1 While the menu is displayed, press [DISPLAY].

Multi	Groups and contents
List	Contents only
✓Tree	Groups only
Thumbnail	Thumbnail images JPEG
Next group	To go to next groups WMA MP3
Previous group	To go to previous groups WMA MP3
All	WMA/MP3 and JPEG files
✓Audio	WMA/MP3 files only
Picture	JPEG files only
✓Help display	To switch between guide messages and the elapsed play time indicator
Find	To search by content or group title

- 2 Press [▲, ▼] to select the submenu and press [ENTER].

Content or group title search WMA|MP3|JPEG

Example: finding a content including the word "LOVE"

- 1 While the menu is displayed, place the cursor on the group title to search a group, or place the cursor on the content title to search contents. Press [DISPLAY].
- 2 Press [▲, ▼] to select "Find" and press [ENTER].

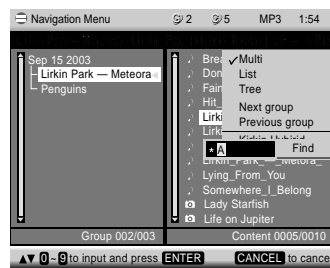

- 3 Press [▲, ▼] to select "L" and press [ENTER]. Characters change in alphanumeric order each time you press [▲]. Repeat this step to enter "O", "V", and "E".
 - Press [◀, ▶] to skip between A, E, I, O, and U.
 - Only upper case letters appear but the search also includes lower case letters.
 - Press [◀] to erase a character.
 - You can erase the asterisk (*) to search for the first word in a title.
 - You can enter numbers with the numbered buttons.
- 4 Press [▶] to select "Find" and press [ENTER]. The search results screen appears.
- 5 Press [▲, ▼] to select the content and press [ENTER].

To use the tree screen to find a group **WMA** **MP3** **JPEG**

- 1 While the menu is displayed
Press [DISPLAY].
- 2 Press [▲, ▼] to select "Tree" and press [ENTER].

Example **MP3**

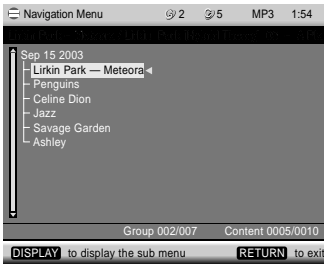

- 3 Press [▲, ▼] to select a group and press [ENTER].

To use the contents screen to find a track **CD** (CD text only)

You can use the text information recorded on these discs to find a track to play.

- 1 Press [TOP MENU] or [MENU] to display the content screen.



- 2 Press [▲, ▼] to move through the tracks and press [ENTER].

- Press [SHIFT]+[PAGE] to skip 10 lines at a time.

See page 31 for details about WMA, MP3, JPEG and CD text .

To exit
Press [RETURN].

Playing HighMAT discs **WMA** **MP3** **JPEG**

A menu appears when you select the disc.
Press [▲, ▼, ◀, ▶] to select then press [ENTER].

When you press [ENTER]:



Menu: Takes you to the next menu which shows play lists or another menu



Play list: play starts

- **To display the screen**
Press [TOP MENU].
- **To return to the menu above the current one**
Press [RETURN].
- **To change the menu background**
Press [DISPLAY].
The background changes to the one recorded on the disc.
- **To exit the screen**
Press [■].

Selecting from the lists

- 1 During play
Press [MENU].



- 2 Press [◀] then [▲, ▼] to switch between the playlist, group and content lists.
- 3 Press [▶] then [▲, ▼] to select an item and press [ENTER].
 - Press [SHIFT]+[PAGE] to skip 10 lines at a time.



HighMAT and the HighMAT logo are either trademarks or registered trademarks of Microsoft Corporation in the United States and/or other countries.

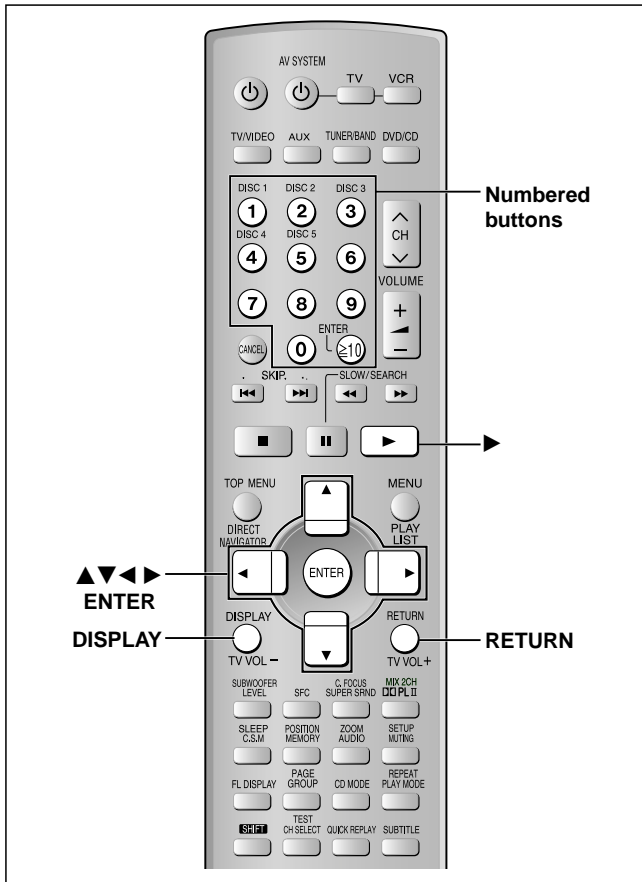

RAM DVD-A DVD-V VCD CD WMA MP3 JPEG

On-Screen Menus are menus that contain information about the disc or unit. These menus allow you to perform operations by changing this information.

Common procedures

1 Press [DISPLAY].

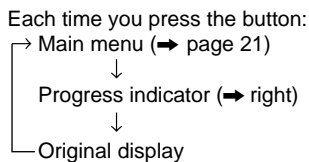

Main menu only

- Press [**▲**, **▼**] to select the item and press [ENTER].
- Press [**▲**, **▼**] to select the setting and press [ENTER].
 - Some items require different operations. Read the explanations on the following pages.

For your reference

- Depending on the condition of the unit (playing, stopped, etc.) and the type of software you are playing, there are some items that you cannot select or change.
- When numbers are displayed (e.g. title No.), the numbered buttons can also be used for setting. After entering the numbers, press [ENTER] to register the setting.

To clear the menus

Press [RETURN] until the menu disappears.

Progress indicator

Indicates how far you have played through an item.

Example **DVD-V**



- Condition-play, pause, or slow/search**
RAM DVD-A DVD-V VCD CD WMA MP3
 Play speed (→ below)
- Current position** **RAM DVD-A DVD-V VCD CD WMA MP3**
- P:** Program number **RAM /Playlist number** **RAM**
T: Title number **DVD-V**
G: Group number **DVD-A WMA MP3 JPEG**
- T:** Track number **DVD-A VCD CD**
C: Chapter number **DVD-V /**
Content number **WMA MP3 JPEG**
- Changing the time display** **RAM DVD-A DVD-V VCD CD**
 Press [**▲**, **▼**] to show the elapsed play time or remaining time.
Elapsed play time **VCD** (SVCD only) **WMA MP3**
 (display only, cannot be changed)

Changing play speed

RAM
DVD-A (Motion picture parts only)
DVD-V (Dolby Digital and DTS)

You can slow down or speed up play.

- During play**
 Press [DISPLAY].
- Press [**▲**, **▼**] to select “Other Settings” and press [ENTER].
- Press [**▲**, **▼**] to select “Play Speed” and press [ENTER].

There are nine speeds:

Example **DVD-V**

Menu	
Title	30/34
Chapter	1/11
Time	0:00:12
Audio	1 English
Subtitle	- - - -
Angle	1/1
Other Settings	
Play Speed	x1.4
Play Menu	x1.3
Picture Menu	x1.2
Audio Menu	x1.1
Display Menu	✓ Normal
	x0.9
	x0.8
	x0.7
	x0.6

- Press [**▲**, **▼**] to select the desired speed and press [ENTER].

After you change the speed, output is in stereo.

To return to normal play (surround sound), press [**▶**] (play) or select “Normal”.

Normal play is also restored when you return the speed to “Normal”.

Unless otherwise indicated, select items with [▲, ▼, ◀, ▶] and then [ENTER].

Items shown differ depending on the type of software.

Main Menu

Program RAM Playlist RAM Group DVD-A WMA MP3 JPEG Title DVD-V Track DVD-A VCD CD Chapter DVD-V Content WMA MP3 JPEG	To start from a specific item
Time <ul style="list-style-type: none"> ● Time Slip (during play) RAM DVD-A DVD-V To skip forward or backward in time 1. Press [ENTER] to show Time Slip indicator. 2. Press [▲, ▼] to select the time and press [ENTER]. <ul style="list-style-type: none"> ● Press and hold [▲, ▼] to change time faster. ● Time Search RAM DVD-A DVD-V To start from a specific time ● Elapsed/Remaining Time RAM DVD-A DVD-V VCD CD To change elapsed/remaining time display 	
Audio RAM DVD-A DVD-V VCD (⇒ page 14) <ul style="list-style-type: none"> ● Karaoke On/Off DVD-V (Karaoke DVD only) If a DVD title is a duet, select V1 or V2 to duet with the unit. Current bitrate (kbps) and sampling frequency (kHz) (WMA MP3) Display only)	
Still Picture DVD-A To switch still picture.	
Thumbnail JPEG To show thumbnail images.	
Subtitle (⇒ page 15) DVD-A (motion picture parts only) DVD-V (with multiple subtitles) VCD (SVCD only) Subtitle On/Off RAM DVD-A DVD-V VCD (SVCD only)	
Marker (VR) RAM To recall a marker recorded on DVD-Video recorders.	
Angle DVD-V (with multiple angles) To select the angle.	
Rotate Picture JPEG To rotate pictures. Right ↔ Left	
Slideshow JPEG <ul style="list-style-type: none"> ● To change the slideshow interval Interval: 0 sec–30 sec ● To turn slideshow on/off On ↔ Off 	

Other Settings

Play Speed

RAM **DVD-V**

To change play speed

– from x0.6 to x1.4 (in 0.1 unit increments)

- After you change the speed

– Output is in stereo.

– Sampling frequency of 96 kHz is converted to 48 kHz.

Play Menu

Repeat (⇒ page 14)

RAM **DVD-A** **DVD-V**

A-B Repeat (⇒ page 14)

RAM **DVD-A** **DVD-V** **VCD** **CD** **WMA** **MP3**

Marker (⇒ page 16)

DVD-A **DVD-V** **VCD** **CD** **WMA** **MP3** **JPEG**

(Continued on next page)

Other Settings

Picture Menu

Picture Mode **RAM DVD-A DVD-V VCD JPEG**

- **Normal:** Normal mode
- **Cinema1:** Mellows images and enhances detail in dark scenes
- **Cinema2:** Sharpens images and enhances detail in dark scenes
- **Animation**
- **Dynamic**
- **User:** User mode (Press [ENTER] to select "Picture Adjustment")(⇒ below)

Picture Adjustment

- **Contrast** (-7 to +7)
Increases the contrast between light and dark parts of the picture.
- **Brightness** (0 to +15)
Brightens the picture.
- **Sharpness** (-7 to +7)
Adjusts the sharpness of the edges of the horizontal lines.
- **Color** (-7 to +7)
Adjust the shade of the picture's color.
- **Gamma** (0 to +5)
Emphasis of outlines.
- **Depth Enhancer** (0 to +4)
– Reduce the rough noise in the background to give a greater feeling of depth.

Video Output Mode **RAM DVD-A DVD-V VCD JPEG**

- **480I:** Interlace mode
- **480P:** Progressive video ("PROG." is on)

Transfer Mode **RAM DVD-A DVD-V VCD**

If you have chosen "480P" (⇒ above), select the method of conversion for progressive output to suit the type of material being played.

- **Auto1 (normal):** for viewing film material
- **Auto2:** for viewing film material (the same as Auto 1, but able to convert 30-frame-per-second progressive video)
- **Video:** for video material

Audio Menu

Dolby Pro Logic II (⇒ page 23)

Dialogue Enhancer On/Off **DVD-V**

(Dolby Digital, DTS, 3-channel or over, with the dialogue recorded in the center channel)

This makes the dialogue in movies easier to hear.

Multi Re-master (⇒ page 25)

RAM DVD-A DVD-V VCD CD WMA MP3

1 ↔ 2 ↔ 3
↑ ↘ Off ←

Display Menu

Information **CD** (CD text only) **WMA MP3**

On ↔ Off

(JPEG): Off, Date, DetailsSubtitle Position **DVD-V**

Position (0 to -60): in 2 unit steps

Subtitle Brightness **DVD-V**

Brightness (Auto*/0 to -7)

* The brightness adjusts automatically against the background.

4:3 Aspect

RAM DVD-A DVD-V VCD JPEG

Select how to show images made for 4:3 aspect screens on a 16:9 aspect television. (⇒ page 28, Video – TV Aspect)

- **Normal:** laterally stretches images made for a 4:3 screen.
- **Auto:** expands suitable 4:3 letterbox images to fill more of the screen. Other images appear in full in the center of the screen.
- **Shrink:** images appear in the center of the screen.
- **Zoom:** expands all images to fill the screen.

If your television has a similar feature, use it instead for a better effect.

Just Fit Zoom (⇒ page 16)

RAM DVD-V VCD**DVD-A** (Motion picture parts only)

Manual Zoom (⇒ page 16)

RAM DVD-V VCD**DVD-A** (Motion picture parts only)

Making fine adjustments (Manual Zoom) to the zoom ratio

Bitrate Display On/Off **RAM DVD-A** (Motion picture parts only)
DVD-V VCD

When you select "On":

During play: shows the bitrate (approximate values) of the video being played

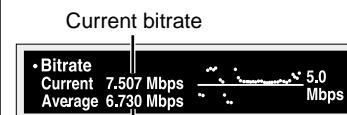

A record of bitrates for a sampling period.

Average bitrate

While paused: shows the data volume of the frame and type of picture (⇒ page 31, Glossary—I/P/B)

GUI See-through On/Off

GUI Brightness (-3 to +3)

Adjust the brightness of the on-screen displays.

Other Menu

Play as DVD-Video or Play as DVD-Audio

While stopped

- Select "Play as DVD-Video" to play DVD-Video contents on DVD-Audio.

Play as DVD-VR, Play as HighMAT or Play as Data Disc

While stopped

- Select "Play as Data Disc" to play JPEG files on DVD-RAM or to play HighMAT disc without using the HighMAT function.

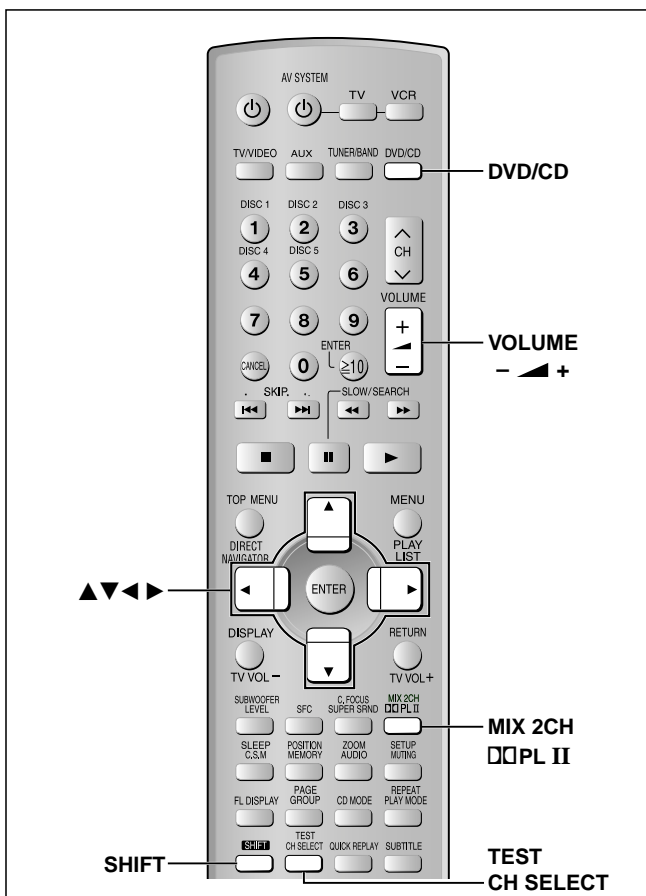

- Super Surround, Center Focus and Subwoofer Level adjustment (→ page 25) cannot be performed if headphones are connected (“ERROR” appears on the display.)
- You may experience a reduction in sound quality when these sound field systems are used with some sources. If this occurs, turn the sound field system off.

Dolby Digital and DTS

- Dolby Digital and DTS are digital encoding systems used on DVD to carry surround sound. Both were originally developed for use in cinemas.
- This unit automatically recognizes and decodes these systems.

Software encoded with Dolby Digital can be identified with this mark.



Software encoded with DTS can be identified with this mark.



Play a Dolby Digital or DTS source.
The Dolby Digital or DTS indicator lights.

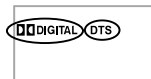

■ To down-mix Dolby Digital or DTS (multiple-channel) signals to 2 channels

Press [SHIFT]+[MIX 2CH].

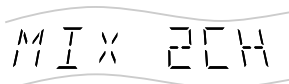

To cancel, press [SHIFT]+[MIX 2CH] again.

When “D.MIX” fishes on the display DVD-A

The DVD-Audio contains multiple-channel signals that cannot be down-mixed.

Dolby Pro Logic II

Only when “DVD/CD” is selected as the source

Dolby Pro Logic II is an advanced decoder that derives 5 channel surround (Left and Right Front, Center, Left and Right Surround) from any stereo program material, whether or not it has been specifically Dolby Surround encoded.

While playing a stereo source

Press [DOL PL II].

Each time you press the button:

MOVIE → MUSIC → OFF

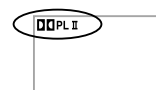

Movie: Use this mode when playing movie software, especially videotapes, recorded in Dolby Surround.

Music: Adds surround effects to stereo sources.

OFF: Cancel

Note

- This does not have any effect when playing multi-channel audio.
- This will only have an effect on speakers.
- “DOL PL II” lights when there is a Dolby Pro Logic II effect.

Speaker level adjustments

Adjust the volume level of the speakers so they are the same apparent level as the front speakers where you would normally be sitting and listening. (L, R → below, “Balance”)

Preparation

Press [DVD/CD].

1 While stopped

Press [SHIFT]+[TEST] for a test signal.

- L: Front left
- C: Center
- R: Front right
- RS: Right surround
- LS: Left surround

2 Press [+ , - , VOLUME] to set the volume level normally used for listening.

3 Press [▲] (to increase) or [▼] (to decrease) to adjust speaker level.

C, RS, LS: -6 dB to +6 dB

To stop the test signal, press [SHIFT]+[TEST] again.

■ To adjust speaker level

(Effective when playing multi-channel audio or Dolby Pro Logic II is on.)

1 Press [CH SELECT] to select the speaker.

L → C → R → RS → LS → SW

SW: Subwoofer

- When Dolby Pro Logic II is turned on, SW does not appear on the display and is not adjustable.

2 Press [▲] (to increase) or [▼] (to decrease).

L, R: (→ below)

C, RS, LS, SW: -6 dB to +6 dB

Balance

You can adjust the balance of the front speakers.

1 During play

Press [CH SELECT] to select “L” or “R”.

2 Press [◀, ▶].

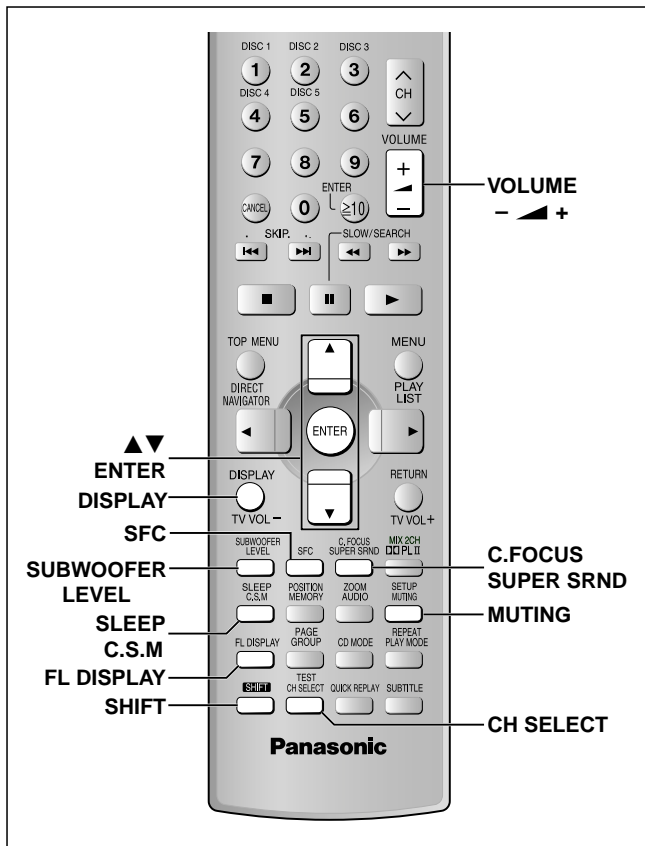

Center Focus

(Discs where the dialogue is recorded in the center channel)

You can make the sound from the center speaker seem like it is coming from within the television.

Press **[SHIFT]+[C.FOCUS]**.

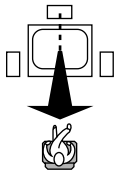

Each time you press the button:

C FOCUS ON \longleftrightarrow C FOCUS OFF

- This will also work when Dolby Pro Logic II is turned on.
- This does not work when Super Surround is turned on.

Custom Sound Memory—Store the sound settings

DVD-A DVD-V VCD CD

Store the sound settings for a disc so the unit recalls them the next time you play it.

- Number of discs: 30
- Settings: Subwoofer level, Sound Field Control, Super Surround, Center Focus.

■ Store the settings

- 1 Make the settings.
- 2 Press and hold **[C.S.M.]**.



■ Recall the settings

The unit recalls the settings when you play the disc again.

- The settings are replaced if you change them.
- When you store settings for a 31st disc, the earliest settings disappear.
- Press **[C.S.M.]** while "CSM" is lit and the settings return to those that were on before the settings were recalled.
- Press **[C.S.M.]** while "CSM" is out and you are playing a disc for which you stored settings and those settings are recalled.

Super Surround

Press **[SUPER SRND]**.

Each time you press the button:

MUSIC \rightarrow MOVIE \rightarrow PARTY
 \leftarrow (off) \leftarrow



MUSIC: Adds surround effects to stereo sources.

MOVIE: Use this mode when playing movie software.

PARTY: Sound is in stereo regardless of the direction you are facing.

To adjust the volume of the surround speakers for better surround effect

- 1 Press **[CH SELECT]** during play.
- 2 Press **[▲]** (to increase) or **[▼]** (to decrease). You can adjust between -6dB and $+6\text{dB}$.

Note

- When Super Surround is on, Dolby Pro Logic II (\rightarrow page 23) turns off.
- This will not work with 5.1-channel source.

Sound Field Control

Press **[SFC]** to select a setting.

Each time you press the button:

HEAVY: Adds punch to rock.

CLEAR: Clarifies higher sounds.

SOFT: For background music.

DISCO: Reverberates sound to make you feel like you are in a disco.

LIVE: Makes vocals more alive.

HALL: Expands sound to make you feel like you are in a hall.

FLAT: Canceled (no effect is added) (factory preset).



To check the current setting

Press **[SFC]**.

Sound quality

Adjusting the subwoofer level

Press [SUBWOOFER LEVEL].

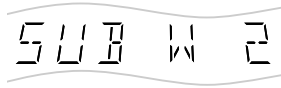

Each time you press the button:

SUB W 1 → SUB W 2 → SUB W 3 → SUB W 4 (factory preset)

Multi Re-master—Enjoying more natural sound

RAM DVD-V (Discs recorded with 48 kHz only)

DVD-A (Discs recorded with 44.1 kHz and 48 kHz only)

VCD CD

- During 2ch output of these discs, this feature gives you a more natural sound by adding the higher frequency signals not recorded on the disc.
- During multi-channel output of these discs, this feature reproduces the frequencies lost during recording to give you a sound closer to the original.

WMA MP3 (Disc recording is other than 8 kHz, 16 kHz, 32 kHz)

This feature reproduces the higher frequencies lost during recording to give you a sound closer to the original.

1 During play

Press [DISPLAY] (→ page 21)

2 Press [▲, ▼] to select the “Other Settings” and press [ENTER].

3 Press [▲, ▼] to select the “Audio Menu” and press [ENTER].

4 Press [▲, ▼] to select “Multi Re-master” and press [ENTER].

5 Press [▲, ▼] to select the setting and press [ENTER].

Example **MP3** Menu

Dolby Pro Logic II	Off	Off
Dialogue Enhancer	On	1 88.2 kHz
Multi Re-master	1	2
		3

Setting	DVD-A DVD-V CD (LPCM/PPCM)	RAM VCD WMA MP3
	Type of music	Effect level
1	High tempo (e.g., pop and rock)	Light
2	Various tempos (e.g., jazz)	Medium
3	Low tempo (e.g., classical)	Strong
Off	Off	Off

Convenient functions

Muting the volume

Press [MUTING].



Volume is reduced to minimum.

To cancel

Press [MUTING] again or reduce the volume to minimum (–dB), then raise it to the required level. Muting is also canceled when you switched the unit to standby.

Changing the unit’s display

During play or pause

Press [FL DISPLAY] to select the desired display.

Every time you press the button:

RAM DVD-A DVD-V MP3 WMA

Time display ↔ Number display

JPEG

When Slideshow is on:

SLIDE ↔ Number display

When Slideshow is off:

PLAY ↔ Number display

The sleep timer

This timer turns the unit off after a set time.

Press [SHIFT]+[SLEEP] to select the time (minutes).

Every time you press the button:

→ SLEEP 30 → SLEEP 60 → SLEEP 90 → SLEEP 120 → OFF →

To cancel the sleep timer

Press [SHIFT]+[SLEEP] to select “OFF”.

To check the SLEEP setting

Press [SHIFT]+[SLEEP] once.

- The time remaining appears.

To change the setting

Press [SHIFT]+[SLEEP] to display the remaining time, then press again to select the required time.

Using headphones

1 Reduce the volume and connect the headphones (not included).

Headphone plug type: 3.5 mm (1/8”) stereo

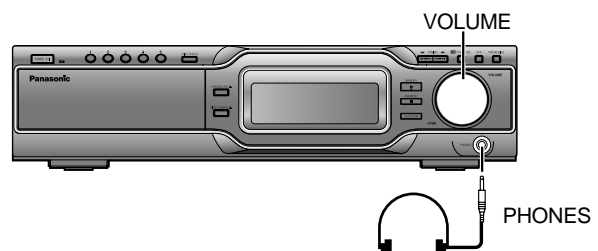

2 Adjust headphone volume with [VOLUME DOWN, UP].

Audio is automatically switched to stereo (2-channel).

Note

Avoid listening for prolonged periods of time to prevent hearing damage.

Operating other equipment

Connection example

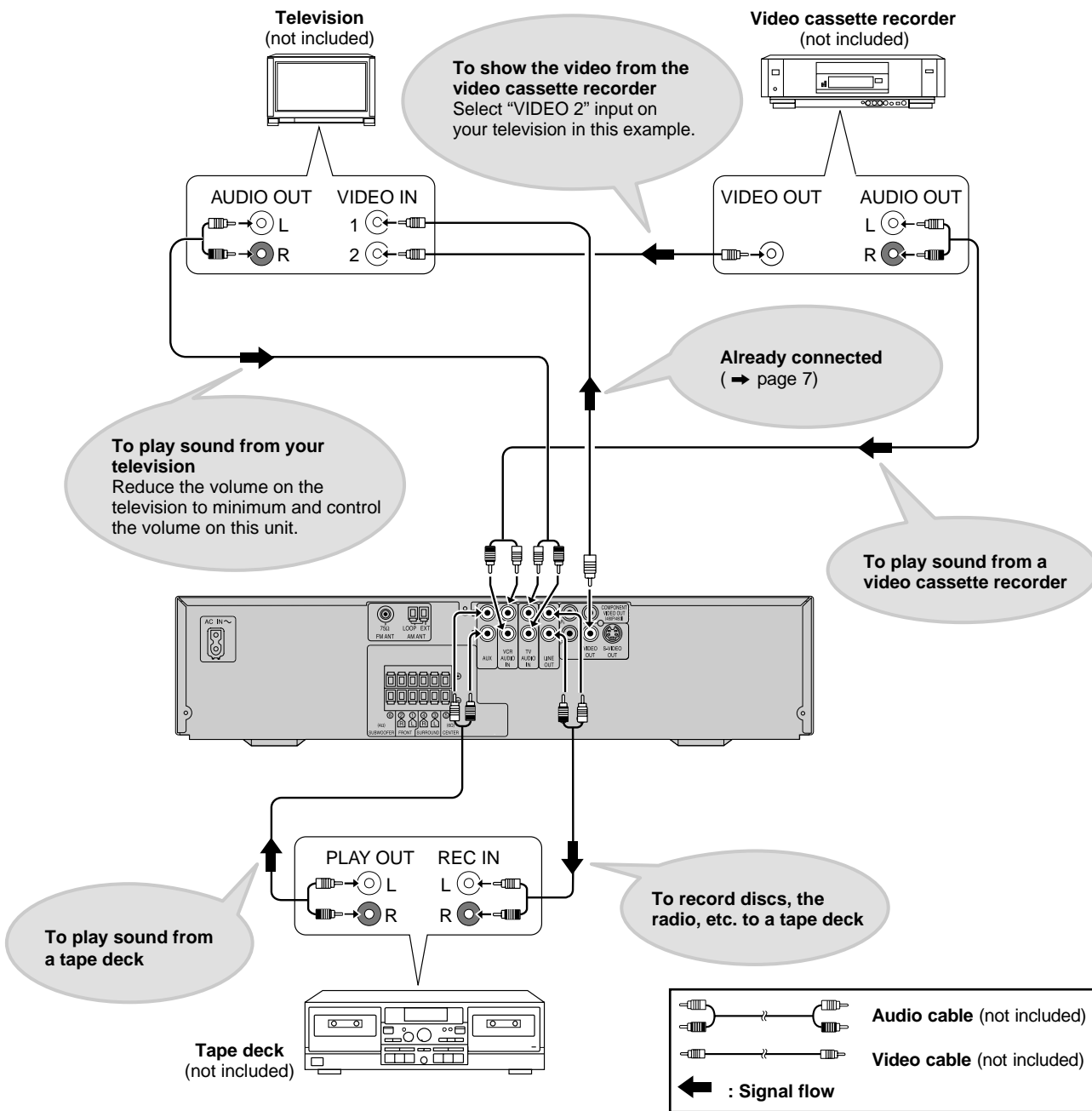

Other functions

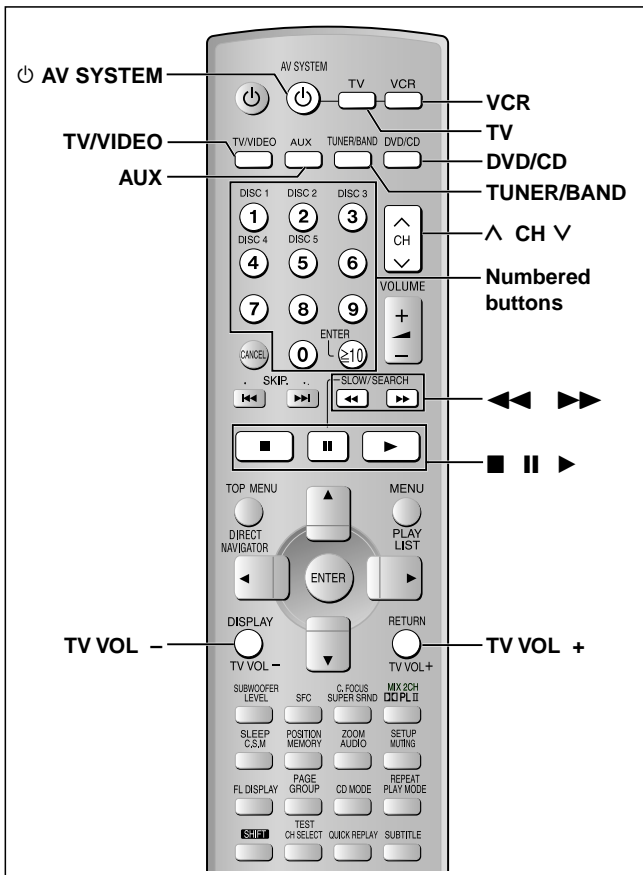

Operating the television and the video cassette recorder

You can use the remote control to operate a Panasonic television or a video cassette recorder. (Some models cannot be operated by this remote control.)

Television

Preparation

- Aim the remote control at this unit and press [TV]. The button lights and "TV" appears on the unit's display. You can operate the television.
- Aim the remote control at the television for the following operations.

Turning the television on/off

Press [⏻ AV SYSTEM].

Switching the television's video input mode

Press [TV/VIDEO].

Changing channels

Press [^ CH] or [CH v].

- [≧10/ENTER] is used to confirm channel selection on some televisions manufactured by other companies.

Adjusting the volume

Press [TV VOL -] or [TV VOL +].

Video cassette recorder

Preparation

- Aim the remote control at this unit and press [VCR]. The button lights and "VCR" appears on the unit's display. You can operate the video cassette recorder.
- Change the video input mode on the television ("VIDEO 2" in the example).
- Aim the remote control at the video cassette recorder for the following operations.

Turning the video cassette recorder on/off

Press [⏻ AV SYSTEM].

Play, pause and stop

Press [▶], [⏸] or [■].

Fast forward and rewind

Press [◀◀] or [▶▶].

You can connect a laser disc or record player instead of a video cassette recorder.

Connect as shown on page 26 and select "VCR" as the source.

When connecting a record player

We recommend using a record player with a built-in phono equalizer. If your player doesn't have a built-in equalizer, connect it first to a separate equalizer and then connect that to this unit.

Changing the remote control code

This remote control can also operate some other brands of television and video cassette recorder. Change the code to operate such equipment and some Panasonic products.

While aiming the remote control at the equipment,

Press and hold [TV] or [VCR],

Press a numbered button to enter the first digit, and then enter the second digit.

The remote control outputs the on/off signal.

If the code is correct, the equipment turns on or off.

If it doesn't, try entering another code.

- Note that this remote control cannot operate some equipment and that it may not be able to perform some operations.
- Re-enter the codes after you change the batteries.

Television code list

Panasonic: 01, 02, 26	Philco: 06, 07
Sony: 04	Philips: 06
Fisher: 14	Pioneer: 02, 10, 19
G-E: 02, 03, 07, 09	Quasar: 02
Gold Star: 07, 15	RCA: 03, 07, 09, 13, 23, 24, 25
Hitachi: 05, 07	Sanyo: 14
JVC: 12	Sharp: 08, 21
LXI: 03, 06, 07, 10, 14, 15	Sylvania: 06, 07, 15
Magnavox: 06, 07, 11, 15, 22	Symphonic: 17
Mitsubishi: 07, 15, 16, 21	Toshiba: 10, 21
NEC: 07, 15	Zenith: 18, 20

Video cassette recorder code list

Panasonic: 01, 02, 09, 33	NEC: 19, 25, 31, 38
Sony: 05, 06, 07, 35, 36, 37	Philco: 02, 09, 12, 30
Fisher: 13, 14, 15, 18, 34	Philips: 02, 09, 12
Funai: 08, 30	Pioneer: 09
G-E: 02, 03, 11	Quasar: 01, 02, 09, 33
Gold Star: 27	RCA: 02, 03, 04, 09, 10, 11, 12, 23, 24, 26
Hitachi: 09, 10, 11	Sanyo: 14, 18, 34
JVC: 19, 25, 31, 38, 39, 40	Sharp: 16, 17
LXI: 10, 13, 14, 15, 18, 27, 30	Shintom: 32
Magnavox: 02, 09, 12	Sylvania: 02, 09, 12, 30
Mitsubishi: 21, 22, 28, 29	Symphonic: 30
	Toshiba: 23, 24
	Zenith: 20

Operating the tape deck

Listening to the tape deck

Press [AUX] to select "AUX" as the source.

Recording to the tape deck

- 1 • **Disc**
Press [DVD/CD] to select "DVD/CD".
• **The radio**
Press [TUNER/BAND] to select "FM" or "AM".
- 2 Start recording and play.

Changing settings

This chart shows the settings for this unit. Change the settings to adapt your preferences and to adapt the unit to the environment in which it is being used. These settings are retained in memory until they are changed, even if the unit is turned off. See page 29 for details on menu operation.

- Underlined items are the factory preset.

The QUICK SETUP enables successive settings of the items in the shaded areas.

Tabs	Items	Options
Disc	Audio Choose the preferred audio language.	<ul style="list-style-type: none"> • <u>English</u> • French • Spanish • Original • Other***** Original: The original language of each disc will be selected. Other *****: Input a code number with the numbered buttons (⇒ page 30).
	Subtitle Choose the preferred subtitle language.	<ul style="list-style-type: none"> • <u>Automatic</u> • English • French • Spanish • Other***** Automatic: If the language selected for "Audio" is not available, subtitles of that language will automatically appear if available on that disc.
	Menus Choose the preferred language for disc menus.	<ul style="list-style-type: none"> • <u>English</u> • French • Spanish • Other***** • Changing the menu language from QUICK SETUP also changes this setting.
	Ratings (⇒ page 29) Set a ratings level to limit DVD-Video play. <ul style="list-style-type: none"> • The password screen is shown if you choose levels 0 to 7 or if you choose "Ratings" when levels 0 to 7 have been selected. • Select "Level 0" to prevent play of discs that do not have ratings levels recorded on them. 	<p>Setting ratings (When level 8 is selected)</p> <ul style="list-style-type: none"> • <u>8 No Limit</u>: All DVD-Video can be played. • 1 to 7: Prohibits play of DVD-Video with corresponding ratings recorded on them. • 0 Lock All: Prohibits play of all DVD-Video. <hr/> <p>Changing ratings (When level 0-7 is selected)</p> <ul style="list-style-type: none"> • <u>Unlock Player</u> • Change Level • Change Password • Temporary Unlock
Video	TV Aspect (⇒ page 9) Choose the setting to suit your television and preference.	<ul style="list-style-type: none"> • <u>4:3 Pan&Scan</u> • 4:3 Letterbox • 16:9
	TV Type (⇒ page 9) Select to suit the type of television.	<ul style="list-style-type: none"> • <u>Standard (Direct View TV)</u> • CRT Projector • LCD TV/Projector • Projection TV • Plasma TV
	Time Delay When connected with a Plasma display, adjust if you notice the audio is out of sync with the video.	<ul style="list-style-type: none"> • <u>0ms</u> • 20ms • 40ms • 60ms • 80ms • 100ms
	Still Mode Specify the type of picture shown when paused.	<ul style="list-style-type: none"> • <u>Automatic</u> • Field • Frame
	Black Level Control Change the black level of the picture if you connected a television through the COMPONENT VIDEO OUT terminals.	<ul style="list-style-type: none"> • <u>Lighter</u>: when connected to a TV through the VIDEO OUT or S-VIDEO OUT terminal. • Darker: when connected to a TV through the COMPONENT VIDEO OUT (Y/P_B/P_R) terminals.
Audio	Dynamic Range Compression (Dolby Digital only) Change the dynamic range for late night viewing.	<ul style="list-style-type: none"> • <u>Off</u> • On: Adjusts for clarity even when the volume is low through compressing the range of the lowest sound level and the highest sound level.
	Audio during Search Choose whether to have sound during search.	<ul style="list-style-type: none"> • <u>On</u> • Off This feature doesn't work for some discs.
	Speaker Setting (⇒ page 29) Set the delay time for your center and surround speakers.	Multi-channel Center: <u>0.0</u> /1.0/2.0/3.0/4.0/5.0 ms Surround (L/R): <u>0.0</u> /5.0/10.0/15.0 ms
Display	Menu Language Choose the preferred language for these menus and the on-screen messages.	<ul style="list-style-type: none"> • <u>English</u> • Français • Español
	On-Screen Messages Choose whether to show on-screen messages or not.	<ul style="list-style-type: none"> • <u>On</u> • Off
Others	FL Dimmer Changes the brightness of the unit's display.	<ul style="list-style-type: none"> • <u>Bright</u> • Dim • Auto: The display is dimmed during play, but brightens when you perform some operations.
	HighMAT Play HighMAT discs as HighMAT discs, or as regular WMA/MP3/JPEG discs.	<ul style="list-style-type: none"> • <u>Enable</u>: Play HighMAT discs as HighMAT discs. • Disable: Play HighMAT discs as regular WMA/MP3/JPEG discs.
	QUICK SETUP (⇒ page 9) Answer questions to adjust basic settings.	<ul style="list-style-type: none"> • <u>Yes</u> • No
	Re-initialize Setting This returns all values in the Setup menus to the default settings.	<ul style="list-style-type: none"> • Yes The password screen is shown if "Ratings" (⇒ page 29) are set. Please enter the same password. Turn the unit off and on again. • <u>No</u>

Entering a password (Ratings)

DVD-V

The password screen is shown when you select levels 0 to 7.

1. Input a 4-digit password with the numbered buttons and press [ENTER].

- If you enter a wrong number, press [CANCEL] to erase it before you press [ENTER].
- The lock symbol appears closed to show the rating is locked.
- **Do not forget your password.**

2. Press [ENTER] to confirm the 4 digits.

Now, when you insert a DVD-Video that exceeds the ratings limit you set, a message appears on the television. Follow the on-screen instructions.

Changing the delay time (Speaker Setting)

DVD-V

(Effective when playing multi-channel audio)
(Center and surround speakers only)

For optimum listening with 5.1-channel sound, all the speakers, except for the subwoofer, should be the same distance from the seating position. If you have to place the center or surround speakers closer to the seating position, adjust the delay time to make up for the difference.

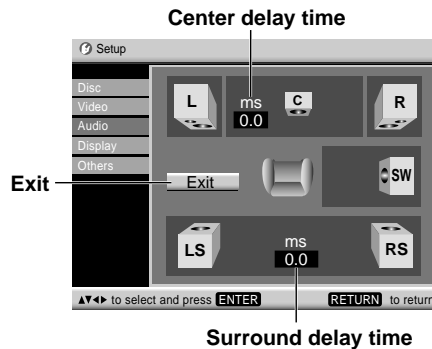

- 1 Press [▲, ▼] to select the delay time box and press [ENTER].
- 2 Press [▲, ▼] to adjust the delay time and press [ENTER].

Values

If distance (a) or (b) is greater than or equal to distance (c), set to "0".

If distance (a) or (b) is less than distance (c), set as follows.

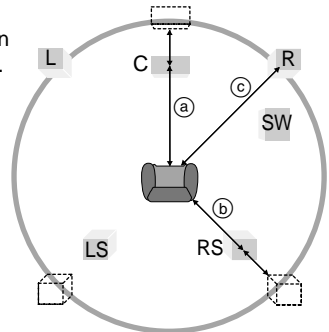

a) Center speaker

Difference	Setting
Approx. 34 cm (1 ¹ / ₁₀ feet)	1.0 ms
Approx. 68 cm (2 ¹ / ₅ feet)	2.0 ms
Approx. 102 cm (3 ³ / ₁₀ feet)	3.0 ms
Approx. 136 cm (4 ² / ₅ feet)	4.0 ms
Approx. 170 cm (5 ¹ / ₂ feet)	5.0 ms

b) Surround speakers

Difference	Setting
Approx. 170 cm (5 ¹ / ₂ feet)	5.0 ms
Approx. 340 cm (11 feet)	10.0 ms
Approx. 510 cm (16 ¹ / ₂ feet)	15.0 ms

When you are finished

Press [◀] to select "Exit" and press [ENTER].

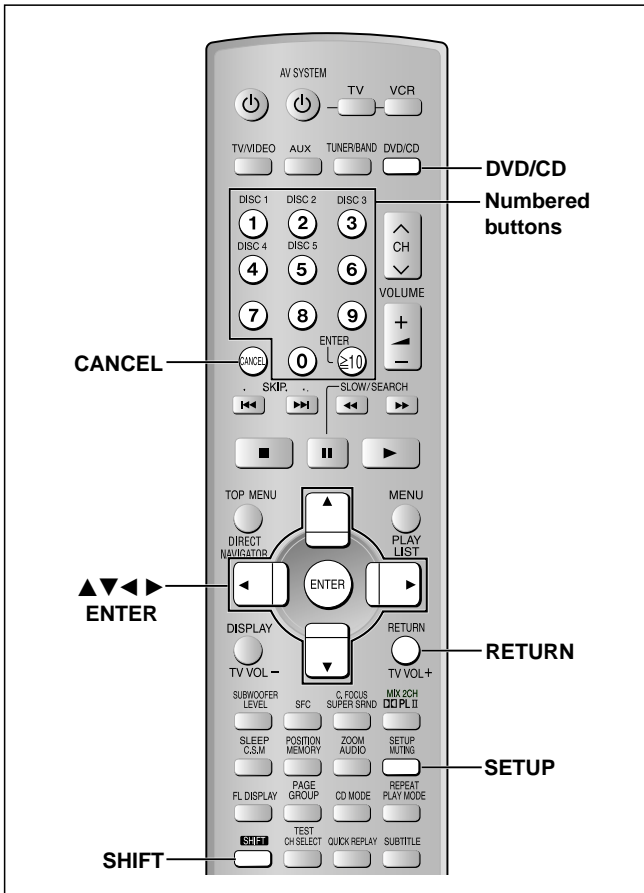

Common procedures

See page 28 for menu and option details.

Preparation

Press [DVD/CD].

- 1 Press [SHIFT]+[SETUP] to show the menus.

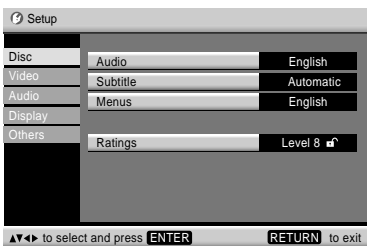

- 2 Press [▲, ▼] to select the menu and press [ENTER].
- 3 Press [▲, ▼] to select the item you want to change and press [ENTER].
- 4 Press [▲, ▼] to select the option and press [ENTER].
The screen now shows the menu again.

To return to the previous screen

Press [RETURN].

When you are finished

Press [SHIFT]+[SETUP].

Language code list

Abkhazian: 6566	Chinese: 9072	Hausa: 7265	Lithuanian: 7684	Romanian: 8279	Telugu: 8469
Afar: 6565	Corsican: 6779	Hebrew: 7387	Macedonian: 7775	Russian: 8285	Thai: 8472
Afrikaans: 6570	Croatian: 7282	Hindi: 7273	Malagasy: 7771	Samoan: 8377	Tibetan: 6679
Albanian: 8381	Czech: 6783	Hungarian: 7285	Malay: 7783	Sanskrit: 8365	Tigrinya: 8473
Ameharic: 6577	Danish: 6865	Icelandic: 7383	Malayalam: 7776	Scots Gaelic: 7168	Tonga: 8479
Arabic: 6582	Dutch: 7876	Indonesian: 7378	Maltese: 7784	Serbian: 8382	Turkish: 8482
Armenian: 7289	English: 6978	Interlingua: 7365	Maori: 7773	Serbo-Croatian: 8372	Turkmen: 8475
Assamese: 6583	Esperanto: 6979	Irish: 7165	Marathi: 7782	Shona: 8378	Twi: 8487
Aymara: 6588	Estonian: 6984	Italian: 7384	Moldavian: 7779	Sindhi: 8368	Ukrainian: 8575
Azerbaijani: 6590	Faroese: 7079	Japanese: 7465	Mongolian: 7778	Singhalese: 8373	Urdu: 8582
Bashkir: 6665	Fiji: 7074	Javanese: 7487	Nauru: 7865	Slovak: 8375	Uzbek: 8590
Basque: 6985	Finnish: 7073	Kannada: 7578	Nepali: 7869	Slovenian: 8376	Vietnamese: 8673
Bengali, Bangla: 6678	French: 7082	Korean: 7579	Norwegian: 7879	Somali: 8379	Volapük: 8679
Bhutani: 6890	Frisian: 7089	Kazakh: 7575	Oriya: 7982	Spanish: 6983	Welsh: 6789
Bihari: 6672	Galician: 7176	Kirghiz: 7589	Pashto, Pushto: 8083	Sundanese: 8385	Wolof: 8779
Breton: 6682	Georgian: 7565	Kurdish: 7585	Persian: 7065	Swahili: 8387	Xhosa: 8872
Bulgarian: 6671	German: 6869	Laotian: 7679	Polish: 8076	Swedish: 8386	Yiddish: 7473
Burmese: 7789	Greek: 6976	Latin: 7665	Portuguese: 8084	Tagalog: 8476	Yoruba: 8979
Byelorussian: 6669	Greenlandic: 7576	Latvian, Lettish: 7686	Punjabi: 8065	Tajik: 8471	Zulu: 9085
Cambodian: 7577	Guarani: 7178	Lingala: 7678	Quechua: 8185	Tamil: 8465	
Catalan: 6765	Gujarati: 7185		Rhaeto-Romance: 8277	Tatar: 8484	

Optional antenna connections

Use outdoor antenna if radio reception is poor.

Note

Disconnect the antenna when the unit is not in use.
Do not use the outdoor antenna during an electrical storm.

AM loop antenna (included)
Leave the loop antenna connected.

AM outdoor antenna (not included) (Using a vinyl wire)
Run a piece of vinyl wire horizontally across a window or other convenient location.

FM outdoor antenna (not included) (Using a television antenna)

- Disconnect the FM indoor antenna.
- The antenna should be installed by a competent technician.

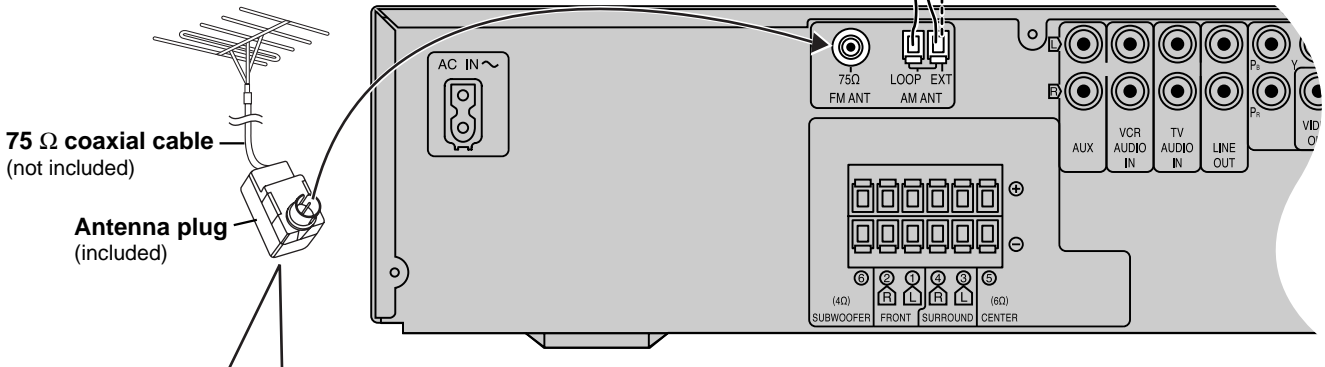

① Remove a piece of the outer vinyl insulator.

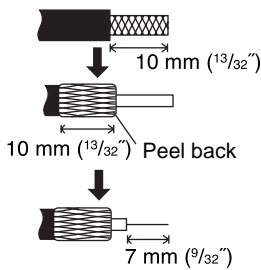

② Carefully pull the tabs apart to remove the cover.

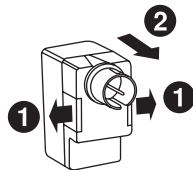

③ Install the coaxial cable. Clamp the cable conductor, and wind it on so that it does not contact anything else.

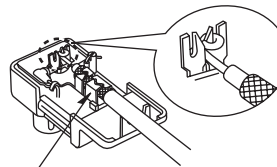

Clamp with pliers

④ Attach the cover.

Glossary

Decoder

A decoder restores the coded audio signals on DVDs to normal. This is called decoding.

Dolby Digital

This is a method of coding digital signals developed by Dolby Laboratories. Apart from stereo (2-channel) audio, these signals can also be multi-channel audio. A large amount of audio information can be recorded on one disc using this method.

DTS (Digital Theater Systems)

This surround system is used in many movie theaters around the world. There is good separation between the channels, so realistic sound effects are possible.

Dynamic range

Dynamic range is the difference between the lowest level of sound that can be heard above the noise of the equipment and the highest level of sound before distortion occurs.

Film and video

DVD-Videos are recorded using either film or video. Usually, film is recorded at 24 frames per second, the rate movies are filmed at, while video is recorded at 30 frames per second.

Frame still and field still

Frames are the still pictures that go together to make a moving picture. There are about 30 frames shown each second. One frame is made up of two fields. A regular television shows these fields one after the other to create frames. A still is shown when you pause a moving picture. A frame still is made up of two alternating fields, so the picture may appear blurred, but overall quality is high. A field still is not blurred, but it has only half the information of a frame still so picture quality is lower.

Interlace and progressive output

NTSC, the video signal standard, has 480 interlaced (I) scan lines, whereas progressive scanning uses twice the number of scan lines. This is called 480P. The video signals output from this unit's COMPONENT VIDEO OUT terminals (Y, P_B, P_R) allow you to enjoy higher quality pictures than if the signals were output from the VIDEO OUT terminal or S-VIDEO OUT terminal.

I/P/B

MPEG 2, the video compression standard adopted for use with DVD-Video, codes frames using these 3 picture types.

I: Intra coded picture

This picture has the best quality and is the best to use when adjusting the picture.

P: Predictive coded picture

This picture is calculated based on past I or P-pictures.

B: Bidirectionally-predictive coded picture

This picture is calculated by comparing past and future I and P-pictures so it has the lowest volume of information.

Linear PCM (pulse code modulation)

These are uncompressed digital signals, similar to those found on CDs.

Playback control (PBC)

If a Video CD has playback control, you can select scenes and information with menus.

WMA, MP3, JPEG and CD text information

- Discs must conform to ISO9660 level 1 or 2 (except for extended formats).
- This unit is compatible with multi-session but if there are a lot of sessions it takes more time for play to start. Keep the number of sessions to a minimum to avoid this.
- The order in which tracks appear in the menus may differ from the order shown on your computer.

WMA

- Noise may occur when playing WMA files.
- You cannot play WMA files that are copy protected.

MP3

- This unit is not compatible with ID3 tags.
- Compatible sampling rate: 8, 11.02, 12, 16, 22.05, 24, 32, 44.1 and 48 kHz.
- If you play an MP3 track that includes still picture data, it will take some time before the music itself starts playing and the elapsed time will not be displayed during this time. Even after the track starts, the correct play time will not be displayed.

JPEG

- To view JPEG files on this unit:
 - Take them on a digital camera that meets DCF Standard (Design rule for Camera File System) Version 1.0. Some digital cameras have functions that are not supported by DCF Standard Version 1.0 like automatic picture rotation which may render a picture unviewable.
 - Do not alter the files in any way or save them under a different name.
- This unit cannot display moving pictures, MOTION JPEG and other such formats, still pictures other than JPEG (i.e. TIFF) or play associated sound.

Order of play

WMA | MP3 | JPEG

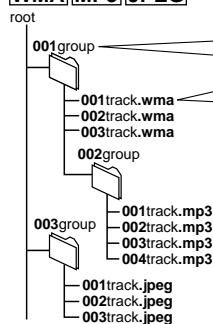

Naming folders and files

Prefix folder and file names with 3-digit numbers in the order you want to play them.

Extension
004track.wma (or .WMA)

The extension for MP3 is ".mp3" or ".MP3".

The extension for JPEG is ".JPG", ".jpg", ".JPEG" or ".jpeg".

CD (CD text only)

When making your own CD text discs

The unit plays the tracks in the order you record them so you do not have to prefix the titles with numbers.

Windows Media, and the Windows logo are trademarks, or registered trademarks of Microsoft Corporation in the United States and/or other countries.



WMA is a compression format developed by Microsoft Corporation. It achieves the same sound quality as MP3 with a file size that is smaller than that of MP3.

MPEG Layer-3 audio decoding technology licensed from Fraunhofer IIS and Thomson multimedia.

Specifications

AMPLIFIER SECTION

RMS Output Power: Dolby Digital Mode

Front Ch	55 W per channel (6 Ω), 1 kHz, 10 % THD
Surround Ch	55 W per channel (6 Ω), 1 kHz, 10 % THD
Center Ch	160 W per channel (6 Ω), 1 kHz, 10 % THD
Subwoofer Ch	220 W per channel (4 Ω), 100 Hz, 10 % THD
Total RMS Dolby Digital mode Power	600 W

FTC Output Power: Dolby Digital Mode

Front Ch	35 W per channel (6 Ω), 120 Hz–20 kHz, 1 % THD
Surround Ch	35 W per channel (6 Ω), 120 Hz–20 kHz, 1 % THD
Center Ch	110 W per channel (6 Ω), 120 Hz–20 kHz, 1 % THD
Subwoofer Ch	140 W per channel (4 Ω), 45 Hz–120 Hz, 1 % THD
Total FTC Dolby Digital mode power	390 W

FM/AM TUNER, TERMINALS SECTION

Preset station	FM 15 stations
	AM/MW 15 stations

Frequency Modulation (FM)

Frequency range	87.9–107.9 MHz (200 kHz step)
	87.5–108.0 MHz (100 kHz step)
Sensitivity	2.5 μV (IHF)
S/N 26 dB	2.2 μV
Antenna terminals	75 Ω (unbalanced)

Amplitude Modulation (AM/MW)

Frequency range	520–1710 kHz (10 kHz step)
AM Sensitivity S/N 20 dB at 1000 kHz	560 μV/m

Phone jack

Terminal	Stereo 3.5 mm (1/8") jack
----------	---------------------------

DISC SECTION

Discs played [8 cm (3") or 12 cm (5")]

- (1) DVD-RAM (DVD-VR compatible, JPEG formatted disc)
- (2) DVD-Audio
- (3) DVD-Video
- (4) DVD-R (DVD-Video compatible)
- (5) CD-Audio (CD-DA)
- (6) Video CD
- (7) SVCD (Conforming to IEC62107)
- (8) CD-R/RW (CD-DA, Video-CD, SVCD, MP3, WMA, JPEG formatted disc)
- (9) MP3/WMA*¹
 - Compatible compression rate:
 - MP3: between 32 kbps and 320 kbps
 - WMA: between 48 kbps and 320 kbps
- (10) JPEG*¹
 - Exif Ver 2.1 JPEG Baseline files
 - Picture resolution: between 320 x 240 and 6144 x 4096 pixels (Sub sampling is 4:2:2 or 4:2:0)
- (11) HighMAT Level 2 (Audio and Image)

*¹ The total combined maximum number of recognizable audio and picture contents and groups: 4000 audio and picture contents and 400 groups.

Pickup

Wavelength	
DVD	662 nm
CD	785 nm
Laser power	U.S.A. CLASS IIa/CLASS I Others CLASS 2/CLASS 3A

Audio output (DISC)

Number of channels	5.1 ch (FL, FR, C, SL, SR, SW)
--------------------	--------------------------------

Audio performance (measured at LINE OUT terminal)

Frequency response	
DVD (linear audio)	4 Hz–22 kHz (48 kHz sampling)
	4 Hz–44 kHz (96 kHz sampling)
DVD-Audio	4 Hz–88 kHz (192 kHz sampling)
CD-Audio	4 Hz–20 kHz
S/N ratio	
CD-Audio	95 dB
Dynamic range	
DVD (linear audio)	95 dB
CD-Audio	93 dB
Total harmonic distortion	
CD-Audio	0.005 %

VIDEO SECTION

Video system

Signal system	NTSC
---------------	------

Composite video output

Output level	1 Vp-p (75 Ω)
Terminal	Pin jack (1 system)

S-video output

Y output level	1 Vp-p (75 Ω)
C output level	NTSC; 0.286 Vp-p (75 Ω)
Terminal	S terminal (1 system)

Component video output (480P/480I)

Y output level	1 Vp-p (75 Ω)
P _B output level	0.7 Vp-p (75 Ω)
P _R output level	0.7 Vp-p (75 Ω)
Terminal	Pin jack (Y: green, P _B : blue, P _R : red) (1 system)

SPEAKER SECTION

Front/Surround speakers SB-FS670

Type	1 way, 1 speaker system (Bass reflex)
Speaker unit(s)	
1 Full range	6.5 cm (2 1/2") Cone type
Impedance	6 Ω
Input power (IEC)	55 W (Max)
Output sound pressure	80 dB/W (1.0 m)
Frequency range	65 Hz–22 kHz (–16 dB)
	90 Hz–20 kHz (–10 dB)
Dimensions (WxHxD)	88 x 194 x 118 mm
	(3 15/32" x 7 7/8" x 4 21/32")
Mass	0.78 kg (1.72 lbs)

Center speaker SB-PC670

Type	2 Way, 3 speaker system (Bass reflex)
Speaker unit(s)	
2 Full range	6.5 cm (2 1/2") Cone type
1 Super tweeter	Piezo type
Impedance	6 Ω
Input power (IEC)	160 W (Max)
Output sound pressure	82 dB/W (1.0 m)
Cross over frequency	10 kHz
Frequency range	85 Hz–22 kHz (–16 dB)
	100 Hz–20 kHz (–10 dB)
Dimensions (WxHxD)	430 x 88 x 115 mm
	(16 15/16" x 3 15/32" x 4 17/32")
Mass	1.54 kg (3.4 lbs)

Subwoofer SB-W670

Type	1 Way, 1 speaker system (Bass reflex)
Speaker unit(s)	
1 Woofer	17 cm (6 3/4") Cone type
Impedance	4 Ω
Input power (IEC)	220 W (Max)
Output sound pressure	81 dB/W (1.0 m)
Frequency range	40 Hz–1 kHz (–16 dB)
	45 Hz–900 Hz (–10 dB)
Dimensions (WxHxD)	269 x 287 x 282 mm
	(10 9/32" x 11 3/16" x 11 3/32")
Mass	3.96 kg (8.73 lbs)

GENERAL

Power supply	AC 120 V, 60 Hz
Power consumption	280 W
Dimensions (WxHxD)	430 x 105 x 372.6 mm
	(16 15/16" x 4 1/8" x 14 11/16")
Mass	7.6 kg (16.75 lbs)
Operating temperature range	+5°C to +35°C (+41°F to +95°F)
Operating humidity range	5 % to 90 % RH (no condensation)

Power consumption in standby mode:	0.5 W
------------------------------------	-------

Note

1. Specifications are subject to change without notice. Mass and dimensions are approximate.
2. Total harmonic distortion is measured by a digital spectrum analyzer.

Troubleshooting guide

Before requesting service, make the following checks. If you are in doubt about some of the check points, or if the remedies indicated in the chart do not solve the problem, refer to the "Customer Services Directory" on page 35 if you reside in the U.S.A., or refer to the "Product information" on backpage if you reside in Canada.

Power		Page
No power.	<ul style="list-style-type: none"> Insert the AC power supply cord securely. 	7
The unit automatically switches to standby mode.	<ul style="list-style-type: none"> The unit was switched to standby by the sleep timer. 	25

Operation		
No response when buttons pressed.	<ul style="list-style-type: none"> Some operations may be prohibited by the disc. The unit may not be operating properly due to lightning, static electricity or some other external factor. <p>Reset procedure: Press [POWER \odot/I] to switch the unit to standby mode and then back ON. Alternatively, press [POWER \odot/I] to switch the unit to standby mode, disconnect the AC power supply cord, and then reconnect it.</p>	— —
No operations can be performed with the remote control.	<ul style="list-style-type: none"> Check that the batteries are installed correctly. The batteries are depleted: replace them with new ones. Point the remote control at the remote control sensor and operate. 	8 8 —
Cannot switch on the television with the remote control.	<ul style="list-style-type: none"> Press [TV] first to operate the television. 	—
Play doesn't start (or stops immediately) when you press [▶] (play).	<ul style="list-style-type: none"> Condensation has formed: Wait 1 to 2 hours for it to evaporate. This unit cannot play discs other than the ones listed in these operating instructions. You can only play DVD-Video if their region number is the same or includes the same region number as the unit or if DVD-Video is marked "ALL". Confirm the region number for the unit on the rear panel. The disc may be dirty and may require cleaning. Ensure that the disc is installed with the label of the side to be played facing. Check that the DVD-RAM has something recorded on it. 	— 5 Cover 5 12 —
Cannot select alternative languages.	<ul style="list-style-type: none"> This function is dependent on software availability. Try selecting from the disc's menu if one is available. 	— 12
No menu displayed.	<ul style="list-style-type: none"> This function is dependent on software availability. 	—
No subtitles.	<ul style="list-style-type: none"> This function is dependent on software availability. Subtitles are not displayed on the television. Display the subtitles. 	— 15
The position of the subtitles is incorrect.	<ul style="list-style-type: none"> Change the position of the subtitles with "Subtitle Position" in the On-Screen Menus. 	22
Soundtrack and/or subtitle language is not the one selected with the SETUP menus.	<ul style="list-style-type: none"> This function is dependent on software availability. 	—
Cannot change angle.	<ul style="list-style-type: none"> This function is dependent on software availability. Even if a disc has a number of angles recorded, these angles may be recorded for specific scenes only. 	—
The SETUP menu cannot be accessed.	<ul style="list-style-type: none"> Select "DVD/CD" as the source. Cancel all group, program and random play. 	— 15
Cannot add markers.	<ul style="list-style-type: none"> You cannot add markers while playing a play list or if the disc's play time doesn't appear on the unit's display. 	—
There are already markers. RAM	<ul style="list-style-type: none"> The unit reads and displays the markers added with a DVD video recorder. You can clear them but they will reappear when you switch the unit to standby, change the source, or change the disc. 	—
Cannot select random or program play.	<ul style="list-style-type: none"> You cannot select random or program play with some DVD-Video. 	—
Folders deeper than the eighth layer on a data disc are not displayed correctly.	<p>WMA MP3 JPEG</p> <ul style="list-style-type: none"> Folders deeper than the eighth layer are displayed as the eighth layer. 	—
You have forgotten your ratings password. Reset all the SETUP settings to Factory Preset.	<ul style="list-style-type: none"> While stopped and "DVD/CD" is the source, press and hold [■] on the unit and [≥ 10] on the remote control for about 3 seconds until "Initialized" disappears from the television. Turn the unit off and on again. All settings will return to the default values. 	—

Listening to the radio		
Noise is heard. "ST" flickers or doesn't light. Sound is distorted.	<ul style="list-style-type: none"> Adjust the position of the FM or AM antenna. Use an outdoor antenna. 	— 30
A beat sound is heard.	<ul style="list-style-type: none"> Turn the television off or separate it from the unit. 	—
A low hum is heard during AM broadcasts.	<ul style="list-style-type: none"> Separate the antenna from other cables and cords. 	—

Sound

No sound. Distorted sound.	<ul style="list-style-type: none"> • Check the connections. • Turn the volume up. • Turn muting off. • Switch off the unit, determine and correct the cause, then switch the unit on. Causes include: <ul style="list-style-type: none"> – Shorting (bare wires touching) of positive and negative speaker wires. – Using speakers with an impedance lower than that rated for this unit. – Straining of the speakers through excessive volume or power. – Using the unit in a hot environment without proper ventilation. 	6 — 25 —
Humming heard during play.	<ul style="list-style-type: none"> • An AC power supply cord or fluorescent light is near the cables. Keep other appliances and cords away from this unit's cables. 	—

Picture

Picture distorted.	<ul style="list-style-type: none"> • Some distortion is normal during SEARCH. 	—
No picture.	<ul style="list-style-type: none"> • Check the connection. • Make sure the television is on. • Ensure the television's video input setting (e.g. VIDEO 1) is correct. 	7 — —
The picture shown on the television is not normal. (The sides of the picture are cut off, the picture is stretched horizontally, or black bands appear at the top and bottom of the screen.)	<ul style="list-style-type: none"> • Change "TV Aspect" in Video. • Use the television to change the aspect to the correct one. If your television cannot change the aspect when input is progressive, try changing to 4:3 Aspect with the On-Screen Menus. • Ensure that the unit is connected directly to the television, and is not connected through a video cassette recorder. • Connect to the component video (480i) input terminals on a television compatible with this unit's copy guard system. You cannot view progressive video if your television is not compatible. • Change the size with the variable zoom function. • The images on PAL system DVD-Audio are compressed for display. They may also appear vertically stretched. 	28 22 — 7 16 —
There is ghosting when progressive output is on.	<ul style="list-style-type: none"> • Press [PROGRESSIVE] so the indicator goes out. This problem is caused by the editing method or material used on DVD-Video, but should be corrected if you use interlace output. 	12
Picture quality is poor.	<ul style="list-style-type: none"> • Check the settings in "Picture Mode" in the Picture Menu. 	22
The picture on the television disappears or stripes appear on the screen.	<ul style="list-style-type: none"> • Mobile telephone chargers can cause some disturbance. • The location and orientation of the antenna are incorrect. If you are using an indoor antenna, change to an outdoor antenna. • The television antenna wire is too close to the unit. Distance the antenna wire of the television from the unit. 	— 30 —
Menus not displayed correctly.	<ul style="list-style-type: none"> • Restore the Manual Zoom to "x1.00". • Set "Subtitle Position" in Display Menu to "0". • Set "4:3 Aspect" in Display Menu to "Normal". 	16 22

Unit displays

The display is dark.	<ul style="list-style-type: none"> • Select "Bright" in "FL Dimmer" in the Others tab. 	28
"NO PLAY"	<ul style="list-style-type: none"> • You inserted a disc the unit cannot play; insert one that can. • You inserted a blank disc. 	5 —
"NO DISC"	<ul style="list-style-type: none"> • You haven't inserted a disc; insert one. • You haven't inserted the disc correctly; insert it correctly. 	— 12
"F61"	<ul style="list-style-type: none"> • Check and correct the speaker cord connections. If this does not fix the problem, there is a power supply problem. Consult the dealer. 	6
"DVD U11"	<ul style="list-style-type: none"> • Disc is dirty. Wipe it clean. 	5
"ERROR"	<ul style="list-style-type: none"> • Incorrect operation performed. Read the instructions and try again. 	—
"DVD H□□" □□ stands for a number.	<ul style="list-style-type: none"> • Trouble may have occurred. The number following "H" depends on the status of the unit. Reset procedure: Press [POWER ⏻/I] to switch the unit to standby mode and then back ON. Alternatively, press [POWER ⏻/I] to switch the unit to standby mode, disconnect the AC power supply cord, and then reconnect it. • If the service numbers fail to clear, note the service number and contact a qualified service person. 	— —

Television displays

No on-screen display.	<ul style="list-style-type: none"> • Select "On" in "On-Screen Messages" in Display. 	28
The disc's menu is displayed in a different language.	<ul style="list-style-type: none"> • Go to Disc in the SETUP menus, and select the preferred language for "Menus". 	28
"Cannot display group xx, content xx."	<ul style="list-style-type: none"> • You are trying to display incompatible contents. 	—

Limited Warranty (ONLY FOR U.S.A.)

Panasonic Consumer Electronics Company,
Division of Matsushita Electric Corporation of America
One Panasonic Way Secaucus, New Jersey 07094

Panasonic Sales Company, Division of Matsushita Electric
of Puerto Rico, Inc.,
Ave. 65 de Infantería, Km. 9.5
San Gabriel Industrial Park, Carolina, Puerto Rico 00985

Panasonic Audio Products Limited Warranty

Limited Warranty Coverage

If your product does not work properly because of a defect in materials or workmanship, Panasonic Consumer Electronics Company or Panasonic Sales Company (collectively referred to as "the warrantor") will, for the length of the period indicated on the chart below, which starts with the date of original purchase ("warranty period"), at its option either (a) repair your product with new or refurbished parts, or (b) replace it with a new or a refurbished product. The decision to repair or replace will be made by the warrantor.

Product or Part Name	Parts	Labor
Audio Products (except items listed below)	One (1) year	One (1) year
All Audio Racks (cabinets)	Thirty (30) days	Not Applicable
Stand Alone Speakers, Subwoofer Speakers	Three (3) years	Three (3) years
USB Reader-Writer, Personal Computer Card Adapters (in exchange for defective item)	One (1) year	Not Applicable
Accessories: Headphones, Cartridges, Microphones, Adapters	Ninety (90) days	Ninety (90) days
Rechargeable Batteries, DVD-R/-RAM Discs (in exchange for defective item)	Ten (10) days	Not Applicable
SD Memory Cards, Rechargeable Battery Packs (in exchange for defective item)	Ninety (90) days	Not Applicable

During the "Labor" warranty period there will be no charge for labor. During the "Parts" warranty period, there will be no charge for parts. You must carry-in or mail-in your product during the warranty period. If non-rechargeable batteries are included, they are not warranted. This warranty only applies to products purchased and serviced in the United States or Puerto Rico. This warranty is extended only to the original purchaser of a new product which was not sold "as is". A purchase receipt or other proof of the original purchase date is required for warranty service.

Carry-In or Mail-In Service

For Carry-In or Mail-In Service in the United States call 1-800-211-PANA (1-800-211-7262) or visit Panasonic web site: <http://www.panasonic.com>
For assistance in Puerto Rico call Panasonic Sales Company (787)-750-4300 or fax (787)-768-2910.

Limited Warranty Limits And Exclusions

This warranty ONLY COVERS failures due to defects in materials or workmanship, and DOES NOT COVER normal wear and tear or cosmetic damage. The warranty ALSO DOES NOT COVER damages which occurred in shipment, or failures which are caused by products not supplied by the warrantor, or failures which result from accidents, misuse, abuse, neglect, mishandling, misapplication, alteration, faulty installation, set-up adjustments, misadjustment of consumer controls, improper maintenance, power line surge, lightning damage, modification, or commercial use (such as in a hotel, office, restaurant, or other business), rental use of the product, service by anyone other than a Factory Servicenter or other Authorized Servicer, or damage that is attributable to acts of God.

THERE ARE NO EXPRESS WARRANTIES EXCEPT AS LISTED UNDER "LIMITED WARRANTY COVERAGE". THE WARRANTOR IS NOT LIABLE FOR INCIDENTAL OR CONSEQUENTIAL DAMAGES RESULTING FROM THE USE OF THIS PRODUCT, OR ARISING OUT OF ANY BREACH OF THIS WARRANTY. (As examples, this excludes damages for lost time, travel to and from the servicer, loss of media or images, data or other memory content. The items listed are not exclusive, but are for illustration only.) **ALL EXPRESS AND IMPLIED WARRANTIES, INCLUDING THE WARRANTY OF MERCHANTABILITY, ARE LIMITED TO THE PERIOD OF THE LIMITED WARRANTY.**

Some states do not allow the exclusion or limitation of incidental or consequential damages, or limitations on how long an implied warranty lasts, so the exclusions may not apply to you. This warranty gives you specific legal rights and you may also have other rights which vary from state to state. If a problem with this product develops during or after the warranty period, you may contact your dealer or Servicenter. If the problem is not handled to your satisfaction, then write to the warrantor's Consumer Affairs Department at the addresses listed for the warrantor.

PARTS AND SERVICE WHICH ARE NOT COVERED BY THIS LIMITED WARRANTY ARE YOUR RESPONSIBILITY.

Customer Services Directory

Obtain Product Information and Operating Assistance; locate your nearest Dealer or Servicenter; purchase Parts and Accessories; or make Customer Service and Literature requests by visiting our Web Site at:

<http://www.panasonic.com/support>

or, contact us via the web at:

<http://www.panasonic.com/contactinfo>

You may also contact us directly at:

1-800-211-PANA (7262),

Monday-Friday 9 am-9 pm; Saturday-Sunday 10 am-7 pm, EST.

For hearing or speech impaired TTY users, TTY: 1-877-833-8855

Accessory Purchases

Purchase Parts, Accessories and Instruction Books online for all Panasonic Products by visiting our Web Site at:

<http://www.pasc.panasonic.com>

or, send your request by E-mail to:

npcparts@panasonic.com

You may also contact us directly at:

1-800-332-5368 (Phone) 1-800-237-9080 (Fax Only) (Monday - Friday 9 am to 8 pm, EST.)

Panasonic Services Company

20421 84th Avenue South, Kent, WA 98032

(We Accept Visa, MasterCard, Discover Card, American Express, and Personal Checks)

For hearing or speech impaired TTY users, TTY: 1-866-605-1277

Service in Puerto Rico

Matsushita Electric of Puerto Rico, Inc. Panasonic Sales Company

Factory Servicenter:

Ave. 65 de Infantería, Km. 9.5, San Gabriel Industrial Park, Carolina, Puerto Rico 00985

Phone (787)750-4300, Fax (787)768-2910

Product Service

- 1. Damage requiring service** – The unit should be serviced by qualified service personnel if:
 - (a) The AC power supply cord or AC adaptor has been damaged; or
 - (b) Objects or liquids have gotten into the unit; or
 - (c) The unit has been exposed to rain; or
 - (d) The unit does not operate normally or exhibits a marked change in performance; or
 - (e) The unit has been dropped or the cabinet damaged.
- 2. Servicing** – Do not attempt to service the unit beyond that described in these operating instructions. Refer all other servicing to authorized servicing personnel.
- 3. Replacement parts** – When parts need replacing ensure the servicer uses parts specified by the manufacturer or parts that have the same characteristics as the original parts. Unauthorized substitutes may result in fire, electric shock, or other hazards.
- 4. Safety check** – After repairs or service, ask the servicer to perform safety checks to confirm that the unit is in proper working condition.

The servicer will require all components to service your system.
Therefore, should service ever be necessary, be sure to bring the entire system.

Product information

For product information or assistance with product operation:

In the U.S.A., refer to "Customer Services Directory" page 35.

In Canada, contact the Panasonic Canada Inc. Customer Care Centre at 1-800-561-5505, or visit the website (www.panasonic.ca), or an authorized Servicentre closest to you.

Manufactured under license from Dolby Laboratories.
"Dolby", "Pro Logic" and the double-D symbol are trademarks of Dolby Laboratories.

"DTS" and "DTS Digital Surround" are registered trademarks of Digital Theater Systems, Inc.

HDCD[®], **HDCD**[®], High Definition Compatible Digital[®] and Pacific Microsonics[™] are either registered trademarks or trademarks of Pacific Microsonics, Inc. in the United States and/or other countries.

HDCD system manufactured under license from Pacific Microsonics, Inc. This product is covered by one or more of the following: In the USA: 5,479,168, 5,638,074, 5,640,161, 5,808,574, 5,838,274, 5,854,600, 5,864,311, 5,872,531, and in Australia: 669114, with other patents pending.

User memo:

DATE OF PURCHASE _____
DEALER NAME _____
DEALER ADDRESS _____
TELEPHONE NUMBER _____

The model number and serial number of this product can be found on either the back or the bottom of the unit.
Please note them in the space provided below and keep for future reference.

MODEL NUMBER _____
SERIAL NUMBER _____

Apparatus Claims of U.S. Patent Nos. 4,631,603, 4,577,216, and 4,819,098, licensed for limited viewing uses only.

This product incorporates copyright protection technology that is protected by method claims of certain U.S. patents and other intellectual property rights owned by Macrovision Corporation and other rights owners. Use of this copyright protection technology must be authorized by Macrovision Corporation, and is intended for home and other limited viewing uses only unless otherwise authorized by Macrovision Corporation. Reverse engineering or disassembly is prohibited.

Maintenance

To clean this unit, wipe with a soft, dry cloth.

- Never use alcohol, paint thinner or benzene to clean this unit.
- Before using chemically treated cloth, read the instructions that came with the cloth carefully.

Before moving the unit, ensure the disc trays are empty.
Failure to do so will risk severely damaging the discs and the unit.

Panasonic Consumer Electronics Company, Division of Matsushita Electric Corporation of America
One Panasonic Way Secaucus,
New Jersey 07094
<http://www.panasonic.com>

Panasonic Sales Company, Division of Matsushita Electric of Puerto Rico, Inc. ("PSC")
Ave. 65 de Infantería, Km. 9.5
San Gabriel Industrial Park, Carolina,
Puerto Rico 00985

Panasonic Canada Inc.
5770 Ambler Drive
Mississauga, Ontario
L4W 2T3
www.panasonic.ca

