

HDD & DVD Player / Recorder

DVDR3300H
DVDR3330H
DVDR5330H

User Manual	6
Bedienungsanleitung	70

Thank you for choosing Philips.

Need help fast?

Read your Quick Use/Start Guide and/or User Manual first for quick tips that make using your Philips product more enjoyable.

If you have read your instructions and still need assistance, you may access our online help at www.philips.com/support



SHOWVIEW™

PHILIPS

Important notes for users in the U.K.

Mains plug

This apparatus is fitted with an approved 13 Amp plug. To change a fuse in this type of plug proceed as follows:

- 1 Remove fuse cover and fuse.
- 2 Fix new fuse which should be a BS1362 5 Amp, A.S.T.A. or BSI approved type.
- 3 Refit the fuse cover.

If the fitted plug is not suitable for your socket outlets, it should be cut off and an appropriate plug fitted in its place.

If the mains plug contains a fuse, this should have a value of 5 Amp. If a plug without a fuse is used, the fuse at the distribution board should not be greater than 5 Amp.

Note: The severed plug must be disposed of to avoid a possible shock hazard should it be inserted into a 13 Amp socket elsewhere.

How to connect a plug

The wires in the mains lead are coloured with the following code: blue = neutral (N), brown = live (L).

- As these colours may not correspond with the colour markings identifying the terminals in your plug, proceed as follows:
 - Connect the blue wire to the terminal marked N or coloured black.
 - Connect the brown wire to the terminal marked L or coloured red.
 - Do not connect either wire to the earth terminal in the plug, marked E (or \perp) or coloured green (or green and yellow).

Before replacing the plug cover, make certain that the cord grip is clamped over the sheath of the lead - not simply over the two wires.

Copyright in the U.K.

Recording and playback of material may require consent. See Copyright Act 1956 and The Performer's Protection Acts 1958 to 1972.

Italia

DICHIARAZIONE DI CONFORMITA'

Si dichiara che l'apparecchio DVDR3300H, DVDR3330H, DVDR5330H Philips risponde alle prescrizioni dell'art. 2 comma 1 del D.M. 28 Agosto 1995 n. 548.

Fatto a Eindhoven

Philips Consumer Electronics
Philips, Glaslaan 2
5616 JB Eindhoven, The Netherlands

Norge

Typeskilt finnes på apparatens underside.

Observer: Nettbryteren er sekundert innkopleet. Den innebygde nettdelen er derfor ikke frakopleet nettet så lenge apparatet er tilsluttet nettkontakten.

For å redusere faren for brann eller elektrisk støt, skal apparatet ikke utsettes for regn eller fuktighet.

For Customer Use:

Read carefully the information located at the bottom or rear of your DVD Recorder and enter below the Serial No. Retain this information for future reference.

Model No. HDD & DVD PLAYER/
RECORDER DVDR3300H,
DVDR3330H, DVDR5330H

Serial No. _____

DK

Advarsel: Usynlig laserstråling ved åbning når sikkerhedsafbrydere er ude af funktion. Undgå udsættelse for stråling.

Bemærk: Netafbryderen er sekundært indkoblet og afbryder ikke strømmen fra nettet. Den indbyggede netdel er derfor tilsluttet til lysnettet så længe netstikket sidder i stikkontakten.

S

Klass 1 laserapparat

Varning! Om apparaten används på annat sätt än i denna bruksanvisning specificerats, kan användaren utsättas för osynlig laserstråling, som överskrider gränsen för laserklass 1.

Observera! Stömbrytaren är sekundärt kopplad och bryter inte strömmen från nätet. Den inbyggda nät delen är därför ansluten till elnätet så länge stickproppen sitter i vägguttaget.

SF

Luokan 1 laserlaitte

Varoitus! Laitteen käyttäminen muulla kuin tässä käyttöohjeessa mainitulla tavalla saattaa altistaa käyttäjän turvallisuusluokan 1 ylittävälle näkymättömälle lasersäteilylle. Oikeus muutoksiin varataan. Laite ei saa olla alttiina tippu- ja roiskevedelle.

Huom. Toiminnanvalitsin on kytketty toisiopuolelle, eikä se kytkä laitetta irti sähköverkosta. Sisäänrakennettu verkko-osa on kytkettyä sähköverkkoon aina silloin, kun pistoke on pistorasiasassa.

CAUTION

VISIBLE AND INVISIBLE LASER RADIATION WHEN OPEN AVOID EXPOSURE TO BEAM

ADVARSEL

SYNLIG OG USYNLIG LASERSTRÅLING VED ÅBNING UNDGÅ UDSÆTTELSE FOR STRÅLING

VARNING

SYNLIG OCH OSYNLIG LASERSTRÅLNING NÄR DENNA DEL ÄR ÖPPNAD BETRAKTA EJ STRÅLEN

VARO!

AVATTAESSA OLET ALTTIINA NÄKYVÄLLE JA NÄKYMÄTTÖMÄLLE LASER SÄTEILYLLE. ÄLÄ KATSO SÄTEESEEN

VORSICHT

SICHTBARE UND UNSICHTBARE LASERSTRAHLUNG WENN ABDECKUNG GEÖFFNET NICHT DEM STRAHL AUSSETZEN

ATTENTION

RAYONNEMENT LASER VISIBLE ET INVISIBLE EN CAS D'OUVERTURE EXPOSITION DANGEREUSE AU FAISCEAU

LASER

Type	Semiconductor laser InGaAlP (DVD) AlGaAs (CD)
Wave length	658 nm (DVD) 790 nm (CD)
Output Power	30 mW (DVD+RW write) 1.0 mW (DVD read) 1.0 mW (CD read)
Beam divergence	84 degrees (DVD) 61 degrees (CD)

Due to the inconsistency of disc formats provided by various disc manufacturers, your DVD system/ player/recorder may require a playability enhancement or upgrade. As DVD technology advances, these enhancement will become common and will be easy to complete. Go to www.philips.com/support for software upgrade.

En raison de la diversité des formats utilisés par les fabricants, votre système DVD peut nécessiter l'ajout de périphériques ou une mise à niveau logicielle. Au fur et à mesure des progrès de la technologie DVD, ces périphériques se font de plus en plus courants et aisés à intégrer. Pour télécharger la mise à niveau logicielle, visitez le site www.philips.com/support.

Debido a los diferentes formatos de discos disponibles en el mercado, es posible que deba realizar mejoras o actualizaciones en el sistema de DVD relativas a las funciones de reproducción. Conforme la tecnología DVD avanza, estas mejoras estarán al alcance de todo tipo de usuarios y se podrán llevar a cabo fácilmente. Visite la página "www.philips.com/support" para buscar información sobre actualizaciones de software.

Da das Disk-Format je nach Hersteller verschieden ist, ist für Ihr DVD-System möglicherweise die Erweiterung der Spielbarkeit oder eine Aktualisierung erforderlich. Da die DVD-Technologie sich ständig weiterentwickelt, werden sich diese Erweiterungen durchsetzen und einfach auszuführen sein. Gehen Sie zu für Ihre Software-Aktualisierung zu "www.philips.com/support".

Doordat fabrikanten verschillende schijfindeligen aanbieden, moet uw dvd-systeem mogelijk worden geüpgradet of uitgebreid. Naarmate de dvd-technologie zich verder ontwikkelt, zullen deze uitbreidingen normaal worden en zult u ze gemakkelijk kunnen uitvoeren. Ga naar "www.philips.com/support" om uw software te upgraden.

A causa della differenza di formato tra i dischi forniti dai vari produttori, il sistema DVD potrebbe richiedere un potenziamento o aggiornamento della riproducibilità. Col progredire della tecnologia DVD, questi potenziamenti diverranno comuni e facili da implementare. Visitare "www.philips.com/support" per scaricare gli aggiornamenti del software.

Copyright notice

"The making of unauthorized copies of copy-protected material, including computer programmes, files, broadcasts and sound recordings, may be an infringement of copyrights and constitute a criminal offence. This equipment should not be used for such purposes."

La réalisation de copies non autorisées de contenu protégé contre la copie, notamment de programmes informatiques, fichiers, diffusions et enregistrement sonores, peut représenter une violation de droits d'auteur et une infraction à la loi. Cet appareil ne doit en aucun cas être utilisé à de telles fins.

"La realización de copias no autorizadas de materiales protegidos contra copias, incluyendo programas de ordenador, archivos, emisiones y grabaciones de sonido, puede ser una violación de derechos de propiedad intelectual y constituir un delito. Este equipo no debe ser utilizado para dicho propósito."

Die unbefugte Vervielfältigung urheberrechtlich geschützter Werke, einschließlich Computerprogramme, Dateien, Rundfunksendungen und musikalischer Werke, kann eine Verletzung des Urheberrechts darstellen und eine Strafbarkeit begründen. Dieses Gerät darf zu den genannten mißbräulichen Zwecken nicht verwendet werden.

"Het zonder toestemming vervaardigen van kopieën van auteursrechtelijk beschermde werken, inclusief computer programma's, bestanden, uitzendingen en geluidsopnames, kan een inbreuk op auteursrechten en een strafbaar feit zijn. De apparatuur dient niet voor dergelijke doeleinden gebruikt te worden."

"Copie non autorizzate di materiale protetto da copie, inclusi programmi per computer, documenti, registrazioni di radiogrammi e suoni, possono essere una violazione del copyright e costituire un illecito penale. Questa apparecchiatura non può essere utilizzata a tali scopi".

Tillverkningen av oörläta kopior av kopieringsskyddat material, bl.a. datorprogram, filer, sändningar och ljudinspelningar, kan innebära ett brott mot copyright-lagstiftningen och därmed vara straffbart. Den här utrustningen bör inte användas i sådana syften

Kopiering af kopibeskyttet materiale, herunder computerprogrammer, filer, udsendelser og lydindspilninger, kan være i strid med reglerne om ophavsret og med lovgivningen. Dette udstyr bør ikke bruges til disse formål

Luvattomien kopioiden tekeminen kopiosuojatusta materiaalista, kuten tietokoneohjelmista, tiedostoista, lähetysistä ja äänitallenteista, voi loukata tekijänoikeuksia ja täyttää rikoksen tunnuserkit. Tätä laitetta ei saa käyttää edellä mainittuun tarkoitukseen

"A cópia não autorizada de material protegido por direitos autorais, incluindo programas de computação, arquivos, transmissões e gravações de áudio poderá infringir direitos autorais e constituir crime. Este equipamento não deve ser usado para tais propósitos".

Η πραγματοποίηση αντιγράφων υλικού που φέρουν προστασία αντιγραφής, όπως προγράμματα υπολογιστών, αρχεία, μεταδόσεις και ηχογραφήσεις, άνευ σχετικής εξουσιοδότησης, ενδέχεται να συνιστά καταστρατήγηση των δικαιωμάτων πνευματικής ιδιοκτησίας, και ως εκ τούτου, ποινικό αδίκημα. Δεν επιτρέπεται η χρήση του εξοπλισμού αυτού για τους σκοπούς αυτούς

"Dokonywanie nielegalnych kopii materiałów chronionych przez prawo autorskie, w tym programów komputerowych, zbiorów, przekazów radiowych i nagrań może stanowić naruszenie praw autorskich i czyn zabroniony prawem karnym. Ten sprzęt nie może być używany w takich celach."

"Bilgisayar programları, dosyaları, yayımlar ve ses kayıtları dahil kopyalanması korunan bilgilerin yetkisiz kopyalanması, kopya haklarına tecavüz olarak kabul edilebilir ve cezalandırılması gereken bir suç olusturabilir. Bu cihaz bu gibi amaçlarla kullanılmamalıdır."

Незаконное создание копий материалов, защищенных от копирования, в том числе компьютерных программ, файлов, музыкальных записей и записей теле- и радиопередач, может являться нарушением закона об авторском праве быть уголовно наказуемым. Данное оборудование не должно использоваться в таких целях.

Index

English----- 6

Deutsch-----70

English

Deutsch

This product complies with the radio interference requirements of the European Community.

 This product complies with the requirements of the following directives and guidelines: 73/23/EEC + 89/336/EEC + 93/68/EEC



Manufactured under license from Dolby Laboratories. "Dolby" and the double-D symbol are trademarks of Dolby Laboratories.

Table of Contents

Special Features	8	Connecting to a camcorder	22
Frequently Asked Questions	9	Option 1: Using the DV IN socket.....	22
Care and Safety Information		Option 2: Using the S-VIDEO In or	
Setup precautions	10	VIDEO In socket	23
Cleaning discs	10	Step 3: Installation and	
HDD (Hard Disk Drive) handling		Set-up	24~25
care	10	Control TV Programmes	
General Information		Switching on to TV programme	26
Introduction	11	Pause live TV function	26
Accessories supplied	11	Instant Replay function	26
Region codes	11	FlexTime function	26
Remote Control	12~13	Before Recording	
Inserting Batteries	14	About temporary HDD storage/	
Using the remote control to operate		Time Shift video bar	27
the system	14	Default recording settings	28~29
Main Unit		Record on Hard Disk	
Sockets behind the flap	15	Recording TV programmes	30
Step 1: Basic Recorder		Simultaneous record and play	
Connections		function	30
Connecting the antenna cables	16	Playback from HDD	30
Connecting the video cable	17	Playback from DVD	30
Option 1: Using the Scart socket		Playback from other device	30
(best picture quality)	17	Watching other TV programmes	31
Option 2: Using the S-Video socket		Automatic recording from a Satellite	
(excellent picture quality)	17	Receiver	31
Option 3: Using the Video (CVBS)		Recording from a DV camcorder	32
socket (good picture quality)	17	Recording from an external device	
Connecting the audio cables	18	(Camcorder/VCR/DVD player)	33
Option 1: Using the analogue audio		About timer recording	34
sockets	18	Timer recording (SHOWVIEW®	
Option 2: Using the digital audio		System)	34~35
socket (Optical or Coaxial)	18	Timer recording (manually)	36
Step 2: Optional Connections		Changing/Deleting a timer	
Connecting to a Cable Box or		recording	37
Satellite Receiver	19	Record on DVD Recordable Disc	
Connecting to a VCR or other		About copying	38
similar device	20	Discs for recording	38
Connecting to a VCR and Cable Box/		Recording to a recordable DVD	39
Satellite Receiver	21	Playback from Hard Disk	
		Basic operation	40

Table of Contents

English

Playback from Disc

Playable discs.....	41
Starting disc playback	41
Playing a DVD video disc	42
Playing a (Super) Video CDs.....	42
Playing a DVD recordable disc.....	42
Playing an MP3 CD	42
Playing a picture disc (slide show).....	43

Additional Playback Features

Searching forwards/backwards.....	44
Using the Play Mode options.....	44
Using the T/C options	45
Selecting a title/chapter	45
Zooming in.....	45
Switching camera angles.....	46
Switching to slow motion play	46
Switching to step playback.....	46
Searching by time.....	46
Changing the audio soundtrack language	47
Changing subtitle language	47
Selecting sound mode.....	47

Edit Recordings - HDD

Using the HDD edit title menu.....	48
Changing the title name	48
Protecting the title (recording).....	48
Deleting a title from HDD	49
Using the HDD edit scene menu	49~50

Editing Recordings - Recordable DVD

About recordable DVD editing	51
Index Picture screen	51
Making the DVD±R/±RW compatible with this recorder.....	51
Using the disc settings menu	52
Changing the disc name.....	52
Protecting the disc.....	52
Erasing disc (DVD±RW only)	53
Making the edited DVD±RW compatible.....	53
Finalising the DVD±R for playback.....	53
Using the title settings menu	54
Changing the title name	54
Playing the entire title including the hidden scenes.....	54
Erasing title.....	54
Using the edit chapters menu	55

Setup Menu Options

Accessing the Setup Menu.....	56
Video settings	57
Language settings.....	57
Sound settings	58
Feature settings.....	59
Setup settings.....	60~61

Firmware Upgrade

Installing the latest firmware	62
--------------------------------------	----

Troubleshooting

Specifications.....

Glossary.....

Display panel symbol/messages..

Special Features

Automatic **SATELLITE** Recording

This function enables you to record a programme from your Satellite Receiver or any other devices. Make sure that the device is connected to the EXT2 AUX-I/O socket of this recorder, and the timer setting has been done on the connected device.

'Time Shift Buffer'

As soon as you turn on this recorder, the programme showing on the TV will be stored into the 'Time Shift Buffer'. It acts as a temporary HDD storage of your recordings. The contents will be automatically deleted after 6 hours or when you turn off this recorder. To store the contents on the hard disk permanently, you have to mark the section in the 'Time Shift Buffer' for recording to prevent them from being deleted.

'FlexTime'

You can watch or recall a TV programme while it is still being recorded. You do not have to wait until the end of the recording before starting playback. You can also watch a different programme from the hard disk while it is recording something else.

'Instant Replay'

You can repeat a scene of a live TV programme by pressing JUMP BACK button on the remote control, as often as you like. If you wish to return to the live TV programme, just press TUNER.

'Pause Live TV'

A live TV programme is now under your control. You can pause the programme by pressing PAUSE button and resume playback at the scene it was interrupted by pressing PLAY button. If you want to return to the live TV programme, just press TUNER.



i.LINK, is also known as 'FireWire' and 'IEEE 1394'. This connection is used for the transfer of high bandwidth digital signals as used by digital video (DV) camcorders. It carries all audio and video signals via a single cable.

SHOWVIEW™

This is a simple programming system for recorders. To use it, enter the programming number associated with your television programme. You can find this number in your favourite listings magazine.

Frequently Asked Questions

English

What kind of disc should I use for recording?

You can only record on DVD±R or DVD±RW discs. DVD±R/±RW is the most compatible recordable DVD format on the market today. They are fully compatible with most of the existing DVD-Video players and DVD-ROM drives in computers.

What is the capacity of a DVD±R/±RW disc?

4.7GB, or equivalent to six CDs. You can store only one hour of recordings on a single disc at the highest quality (DVD standard) and about 8 hours recordings at the lowest quality (VHS standard).

What is the difference between DVD±R and DVD±RW?

DVD±R is “recordable” and DVD±RW is “erasable” and “rewritable”. With a DVD±R, you can record multiple sessions on the same disc. But when the disc is full, you cannot record any more on the disc. The DVD±RW allows you to record over the same disc again and again.

What is DV?

Using DV, also known as i.LINK, you can connect a DV-equipped camcorder to this recorder using a single DV cable for input and output of audio, video, data and control signals.

- This recorder is only compatible with DV-format (DVC-SD) camcorders. Digital satellite tuners and Digital VHS video recorders are not compatible.
- You cannot connect more than one DV camcorder at a time to this recorder.
- You cannot control this recorder from external equipment connected via the DV IN socket.

Can I copy a VHS tape or DVD from an external player?

Yes, but only if the VHS tape or DVD is not copy-protected.

What are Titles and Chapters?

A DVD disc contains Titles and Chapters, which are similar to the Titles and Chapters of a book. A Title is often a complete movie and is broken down into Chapters, or individual scenes from the movies.

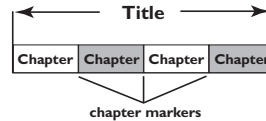

Programmes are recorded as a single title. They may consist of one chapter or a few chapters within a title, depending on the recording settings.

How do I set up Titles and Chapters?

The recorder will automatically create a new Title every time you start a new recording. You can then add Chapters to these recordings manually or have them automatically inserted at a specific intervals.

What does “finalising” a disc do?

Finalising a disc locks the disc so it can no longer be recorded. This is only required for DVD±R. It will then be compatible with virtually any DVD player. To remove a disc without finalising it, simply stop recording and eject the disc. You will still be able to record on the disc if there is room for more recordings.

How good is the quality of the recording?

There are a few picture quality levels to choose from, ranging from “HQ” (1 hour recording at high quality) to “SEP” (8 hours recording at VHS quality) on a recordable DVD. Press REC MODE button on the remote control to choose the quality level that best suits your purpose and the length of recording.

Record Mode	Hours of recordings can be stored on the HDD or an L empty 4.7GB DVD recordable disc.			
	DVDR3300H HDD (80GB)	DVDR3330H HDD (160GB)	DVDRS330H HDD (250GB)	DVD±R/ DVD±RW
HQ (high quality)	16	30	50	1
SP (standard play)	32	60	100	2
SPP (standard play plus)	40	80	120	2.5
LP (long play)	48	90	150	3
EP (extended play)	64	120	200	4
SLP (super long play)	96	180	300	6
SEP (super extended play)	130	250	400	8

Care and Safety Information

CAUTION!

High voltage! Do not open.
You run the risk of getting an electric shock.

The machine does not contain any user-serviceable parts. Please leave all maintenance work to qualified personnel.

Setup precautions

Finding a suitable location

- Place the set on a flat, hard and stable surface. Do not place the set on a carpet.
- Do not position the set on top of other equipment that might heat it up (e.g., receiver or amplifier).
- Do not put anything under the set (e.g., CDs, magazines).
- Install this unit near the AC outlet and where the AC power plug can be reached easily.

Space for ventilation

- Place the apparatus in a location with adequate ventilation to prevent internal heat build up. Allow at least 10 cm (4.5") clearance from the rear and the top of the set and 5cm (2.3") from the left and right to prevent overheating.

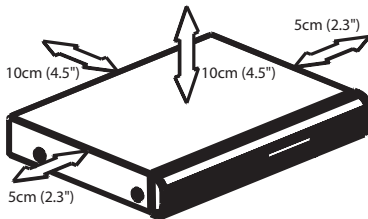

Avoid high temperatures, moisture, water and dust

- Apparatus must not be exposed to dripping or splashing.
- Do not place any sources of danger on the apparatus (e.g., liquid filled objects, lighted candles).

Cleaning discs

Some problems occur (frozen picture, sound disruptions, picture distortions) because the disc inside the recorder is dirty. To avoid these problems, discs should be cleaned on a regular basis.

To clean a disc, use a micro fibre cleaning cloth and wipe the disc from the center to the edge in a straight line.

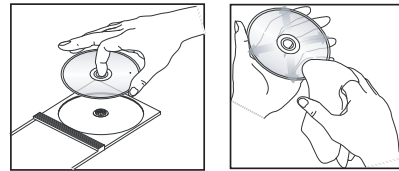

CAUTION!

Do not use solvents such as benzene, thinner, commercially available cleaners, or anti-static sprays intended for discs.

HDD (Hard Disk Drive) handling care

The HDD is a fragile piece of device that is easily prone to damage due to its long recording capacity and high speed operation.

- Do not move the unit while it is turned on.
- Do not remove the AC power plug from the power outlet during operation.
- Do not use the unit in excessively hot or humid places. It may cause condensation to form inside the unit.

If the HDD fails, playback and recording are not possible. In this case, it will be necessary to replace the HDD unit.

WARNING!

The HDD is not a device for storing recorded content permanently. We recommend that you copy the important video content to a recordable DVD disc as backup.

General Information

Introduction

This recorder has a built-in hard disk drive (HDD). You can record up to 130 to 400 hours of video in SEP (Super Extended Play) recording mode depending on model (see below).

Model	Internal hard disk drive	Maximum recording hours
DVDR3300H	80 GB	130
DVDR3330H	160 GB	250
DVDR5330H	250 GB	400

With both recordable DVD and high-capacity HDD in the same recorder, you have the flexibility to keep recordings on the HDD or copy to a recordable DVD for safekeeping or later viewing.

Furthermore, you can take advantage of features like 'FlexTime', 'Instant Replay', or 'Pause Live TV', see page 26 for more information.

Before you can start using this recorder, you must complete the basic connection and set-up in three easy steps.

- Step 1: Basic recorder connections (pages 16~18)
- Step 2: Optional connections for other devices (pages 19~23)
- Step 3: Do the basic installation and set-up (pages 24~25)

Please take time to read this user manual before using your recorder. It contains important information and notes regarding operation of the recorder.

Helpful Hints:

- If you have questions or if problems come up during operation, see the chapter 'Troubleshooting'.
- If you need further assistance, call the customer support service in your country. The corresponding telephone numbers and e-mail addresses are given in the guarantee booklet.
- Refer to the type plate at the rear or bottom of the product for identification and supply ratings.

Accessories supplied

- Quick Start Guide
- RF coaxial cable
- Scart cable
- Remote control and batteries

Region codes

DVD films are usually not released at the same time in all regions of the world, thus all DVD players/recorders are keyed to a specific region code.

This device will only play **Region 2** DVDs or DVDs manufactured to be played in all regions '**ALL**'. DVDs from other regions cannot be played on this recorder.



Remote Control

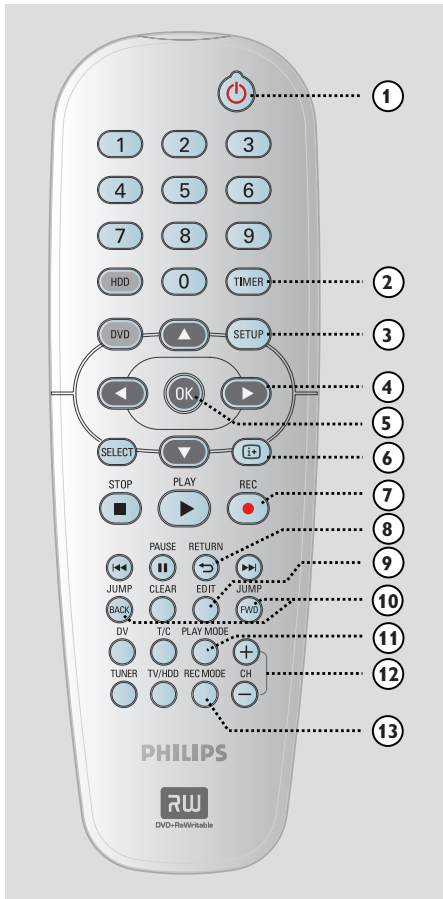

- ① **Power**
– Turns the recorder on or to standby mode.
- ② **TIMER**
– Enters/Exits the timer recording menu.
- ③ **SETUP**
– Enters/Exits the system setup menu.
- ④ **◀▶**: Cursor buttons for moving to the left or right.
▲▼: Cursor buttons for moving up or down.

- ⑤ **OK**
– Confirms an entry or selection.
– Starts playback of the selected title in the menu.
- ⑥ **i+**
– Displays the Time Shift video bar while in tuner mode. It shows the timing of the TV programmes stored in the temporary HDD storage.
- ⑦ **REC ●**
– Accesses the recording input time for transferring the TV programmes from the temporary storage (or the current video input source) onto the HDD.
- ⑧ **RETURN**
– Returns to the previous menu on a video CD (VCD) or some DVDs.
- ⑨ **EDIT**
– Enters/Exits the video editing menu.
- ⑩ **JUMP-FWD**
– Jumps forward by 30 seconds at each press during playback.
- JUMP-BACK**
– Jumps backward by 30 seconds at each press during playback.
- ⑪ **PLAY MODE**
– Accesses various play mode options.
- ⑫ **CH +/-**
– While in tuner mode, selects the next or previous TV channel or the external input source (EXT1, EXT2, CAM1, CAM2).
- ⑬ **REC MODE**
– Selects a recording speed : HQ, SP, SPP, LP, EP, SLP or SEP.
This determines the quality of the recording and the amount/length of time you can record on the HDD and recordable DVD.

Remote Control (continued)

- ⑭ **Numeric keypad 0-9**
 - Selects a chapter/track number to play.
 - Selects the recorder's preset TV tuner channel.
- ⑮ **HDD**
 - Accesses the HDD content menu.
- ⑯ **DVD**
 - Switches to disc mode or displays the disc content menu.
- ⑰ **SELECT**
 - Selects a function.
- ⑱ **PLAY ►**
 - Start playback of the selected title/track.
- ⑲ **STOP ■**
 - Stops playback/recording.
 - Hold down this button to open or close the disc tray.
- ⑳ **PAUSE II**
 - Pauses the playback or recording.
 - Press repeatedly to advance a paused picture one frame at a time.
- ㉑ **⏮ ⏭**
 - Skips to the previous or next chapter/track.
 - Hold down this button for fast reverse or fast forward search.
 - Slow backward/forward search while in pause mode.
- ㉒ **CLEAR**
 - Clear a timer programme entry.
 - Delete the HDD title.
 - Delete the recording.
- ㉓ **DV**
 - Switches to 'camera mode' for camcorder connected to DV IN socket. The recording will be made directly onto the HDD.
- ㉔ **T/C**
 - Enters the T/C tools menu.

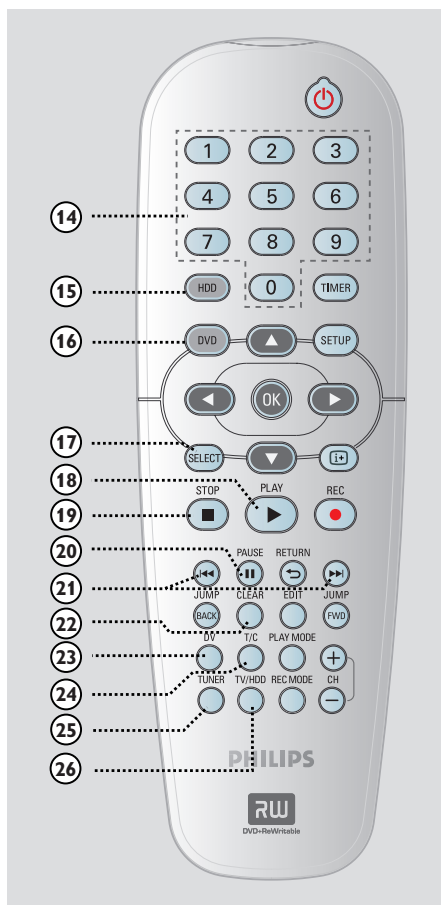

- ㉕ **TUNER**
 - Switches to the recorder's tuner mode (TV channel).
- ㉖ **TV/HDD**
 - (only applicable when using the EXT1 TO TV-I/O scart socket to connect your TV)*
 - Switches to the device that is connected to the EXT2 AUX-I/O scart socket of this recorder.
 - Toggles between the recorder and TV mode if there is no video input signal from the EXT2 AUX-I/O scart socket.

Remote Control (continued)

Inserting Batteries

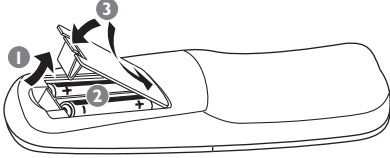

- 1 Open the battery compartment.
- 2 Insert two batteries type R06 or AA, following the indications (+ -) inside the compartment.
- 3 Close the cover.

CAUTION!

- Remove batteries if they are exhausted or if the remote control is not to be used for a long time.
- Do not mix batteries (old and new or carbon and alkaline, etc.).
- Batteries contain chemical substances, so they should be disposed of properly.

Using the remote control to operate the system

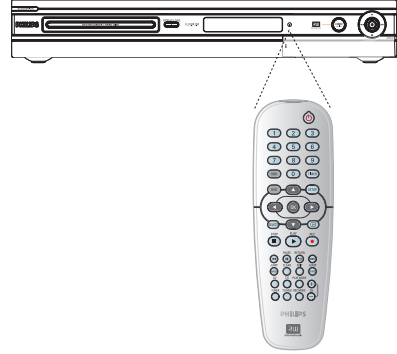

- 1 Aim the remote control directly at the remote sensor (iR) on the front panel.
- 2 Select the source you wish to control by pressing **TUNER**, **HDD** or **DVD** button.
- 3 Select the desired function (for example **◀◀**, **▶▶**).

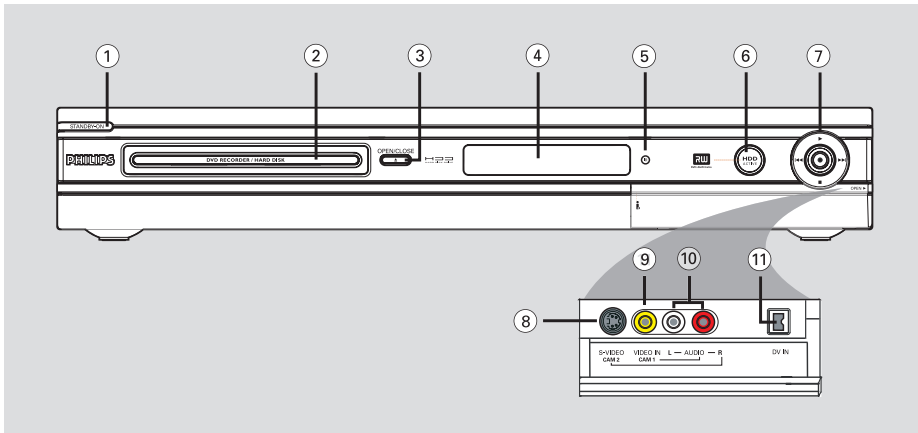

- ① **STANDBY-ON**
- Turns the recorder on or to standby mode.
- ② **Disc tray**
- ③ **OPEN CLOSE**
- Opens or closes the disc tray.
- ④ **Display panel**
- Shows information about the current status of the recorder.
- ⑤ **iR**
- Point the remote control towards this sensor.
- ⑥ **HDD Active indicator**
- Lights up while the recorder is switched on.
- ⑦
- Accesses recording input time for transferring the TV programmes from the temporary storage (or the current video input source) onto the HDD.
- Lights up while recording to the HDD or recordable DVD is in progress.
-
- Start playback the selected title/track.
-
- Skips to the previous or next chapter/ track. Hold down the button to make a reverse/forward search.

-
- Stops playback/recording.

Sockets behind the flap

Flip down the door as indicated by the **OPEN** label at the right hand corner.

- ⑧ **S-VIDEO**
- S-video input for SVHS/Hi8 camcorders or SVHS/Hi8 video recorders.
- In tuner mode, press **CH** + / - on the remote control repeatedly to select 'CAM2' when using this input source.
- ⑨ **VIDEO**
- Video input for camcorders or video recorders.
- In tuner mode, press **CH** + / - on the remote control repeatedly to select 'CAM1' when using this input source.
- ⑩ **L/R AUDIO**
- Audio input for camcorder or the audio/video device which is connected to the S-VIDEO or VIDEO socket.
- ⑪ **DV IN**
- Inputs for digital camcorders or other suitable devices using this connector.
- Press **DV** on the remote control when using this input source.

Step I: Basic Recorder Connections

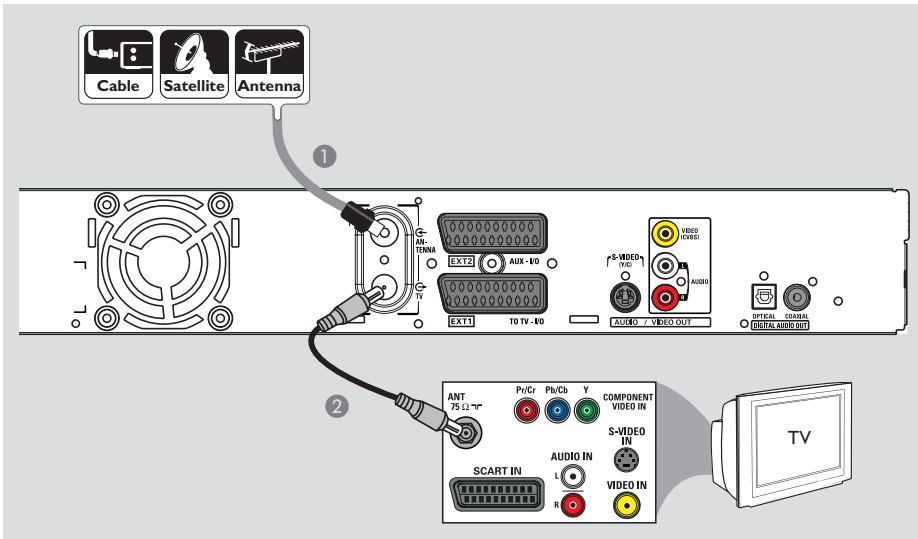

Connecting the antenna cables

These connections enable you to watch and record TV programmes using this recorder. If the antenna signal is connected via a Cable Box or Satellite Receiver, ensure that these devices are turned on in order to watch or record the cable programmes.

- **If you want to connect to a VCR and/or a separate Cable Box/Satellite Receiver**, see page 19~21 for other possible connections.

- 1 Connect the existing Antenna/Satellite/Cable TV signal (or from the Cable Box/Satellite Receiver, labelled as RF OUT or TO TV) to the **ANTENNA** socket on the recorder.
- 2 Use the supplied RF coaxial cable to connect the **TV** socket on the recorder to the antenna input socket (or labelled as VHF/UHF RF IN) on your TV.

Helpful Hint:

– Depending on how you have currently connected your TV channel (directly from an off-air antenna or Cable box or VCR), you'll have to disconnect some of the cables before you make the above connection.

TIPS: Before making or changing any connections, make sure that all the devices are disconnected from the power outlet.

Step 1: Basic Recorder Connections (continued)

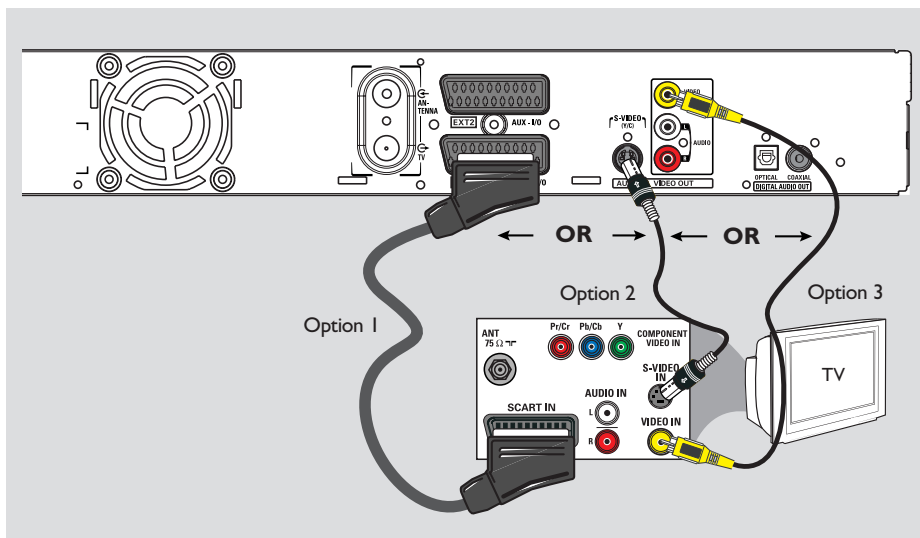

Connecting the video cable

This connection enables you to view the playback from this recorder. You only need to choose **one** of the options below to make your video connection.

Option 1: Using the Scart socket (best picture quality)

- Use the scart cable to connect the **EXT1 TO TV-I/O** socket on the recorder to the corresponding SCART input socket on the TV.

Helpful Hints:

- If your TV displays a selection for the SCART socket, select 'VCR' as the source for the SCART socket.
- The EXT2 AUX-I/O socket is intended only for additional devices.

Option 2: Using the S-Video socket (excellent picture quality)

- Use an S-video cable (not supplied) to connect the **S-VIDEO (Y/C)** socket on the recorder to the S-Video input socket (or labelled as Y/C or S-VHS) on the TV.
→ Audio connection is required in order to hear the sound, see page 18.

Option 3: Using the Video (CVBS) socket (good picture quality)

- Use a composite video cable (yellow - not supplied) to connect the **VIDEO (CVBS)** socket on the recorder to the video input socket (or labelled as A/V In, Video In, Composite or Baseband) on the TV.
→ Audio connection is required in order to hear the sound, see page 18.

TIPS: Before making or changing any connections, make sure that all the devices are disconnected from the power outlet.

Step 1: Basic Recorder Connections (continued)

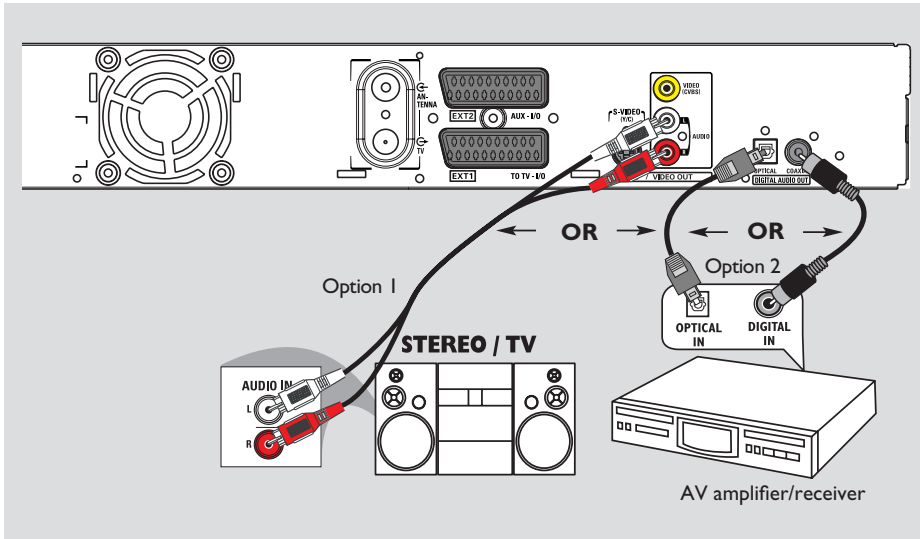

Connecting the audio cables

This connection enables you to listen to the playback from this recorder. However, this connection is not required if this recorder is connected to the TV using the supplied scart cable.

Option 1: Using the analogue audio sockets

You can connect the recorder to a two channel stereo system (mini system, TV) or receiver in order to enjoy the stereo sound system.

- Use an audio cable (red/white - not supplied) to connect the **AUDIO OUT L/R** sockets to the audio input sockets of the connected device.

Option 2: Using the digital audio socket (Optical or Coaxial)

You can connect the recorder to an AV amplifier/receiver in order to enjoy multichannel surround sound.

- Use a coaxial cable (not supplied) to connect the **COAXIAL-DIGITAL AUDIO OUT** socket to the digital coaxial input socket (or labelled as COAXIAL IN or DIGITAL IN) of the connected device.
 - an A/V receiver or amplifier with a digital multi-channel sound decoder.
 - a receiver with two-channel digital stereo (PCM).
- OR
- Use an optical fibre-optic cable (not supplied) to connect the **OPTICAL-DIGITAL AUDIO OUT** socket to the optical input socket of the connected device.
 - Make sure that both plugs are fully inserted (until a click is heard).
 - Remove the dust caps from the optical socket. Keep the caps in a safe place.

TIPS: For option 2 connection, you have to set the appropriate Digital Audio Output setting, see page 58. Otherwise, no sound or a loud noise may occur.

Step 2: Optional Connections

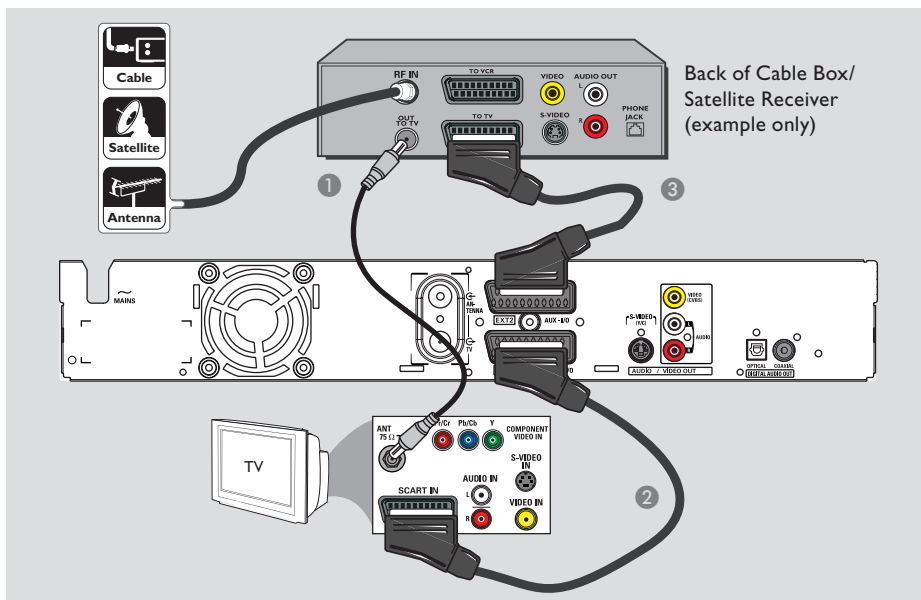

English

Connecting to a Cable Box or Satellite Receiver

Option 1

If your Cable Box/Satellite Receiver has only an antenna output socket (RF OUT or TO TV), refer to “Connecting the antenna cables” on page 16 for the complete connection to your TV.

Option 2 (as shown on the above illustration) If your Cable Box/Satellite Receiver has a Scart output socket

- 1 Keep the existing antenna connection from the Cable Box/Satellite Receiver to your TV.
- 2 Use the scart cable to connect the **EXT1 TO TV-I/O** socket on the recorder to the corresponding SCART input socket on the TV.
- 3 Use another scart cable to connect the **EXT2 AUX-I/O** socket on the recorder to the Scart output socket (or labelled as TV OUT or TO TV) on the Cable Box/Satellite Receiver.

TIPS: The device that connected to the EXT 2 AUX-I/O socket will pass its video/audio signals through the EXT 1 TO TV-I/O socket and display on the TV.

Step 2: Optional Connections (continued)

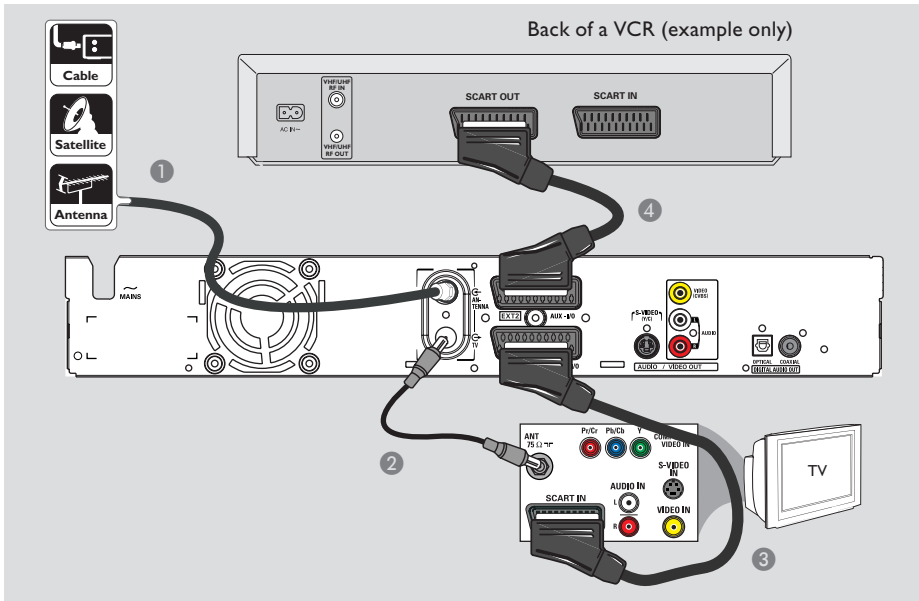

Connecting to a VCR or other similar device

This connection enables you to record from video tape to HDD and allows the VCR to be used for playback on the TV if the recorder is turned off.

IMPORTANT!

Your new recorder can replace the VCR for all your recording needs. Just unplug all the connections to your VCR.

- 1 Connect the existing Antenna/Satellite/Cable TV signal (or from the Cable Box/Satellite Receiver, labelled as RF OUT or TO TV) to the **ANTENNA** socket on the recorder.

- 2 Use the supplied RF coaxial cable to connect the **TV** socket on the recorder to the antenna input socket (or labelled as VHF/UHF RF IN) on your TV.
- 3 Use the scart cable to connect the **EXT1 TO TV-I/O** socket on the recorder to the corresponding SCART input socket on the TV.
- 4 Use another scart cable to connect the **EXT2 AUX-I/O** socket on the recorder to the Scart output socket (or labelled as TV OUT or TO TV) on the VCR.

Helpful Hints:

- Most commercial video cassettes and DVDs are copy-protected and therefore cannot be recorded.
- Connect the recorder directly to the TV. If there is a VCR or an additional device in between, the picture quality may be poor because of the copy protection system built into this recorder.

TIPS: Refer to your optional connected devices' user manual for other possible connections.

Step 2: Optional Connections (continued)

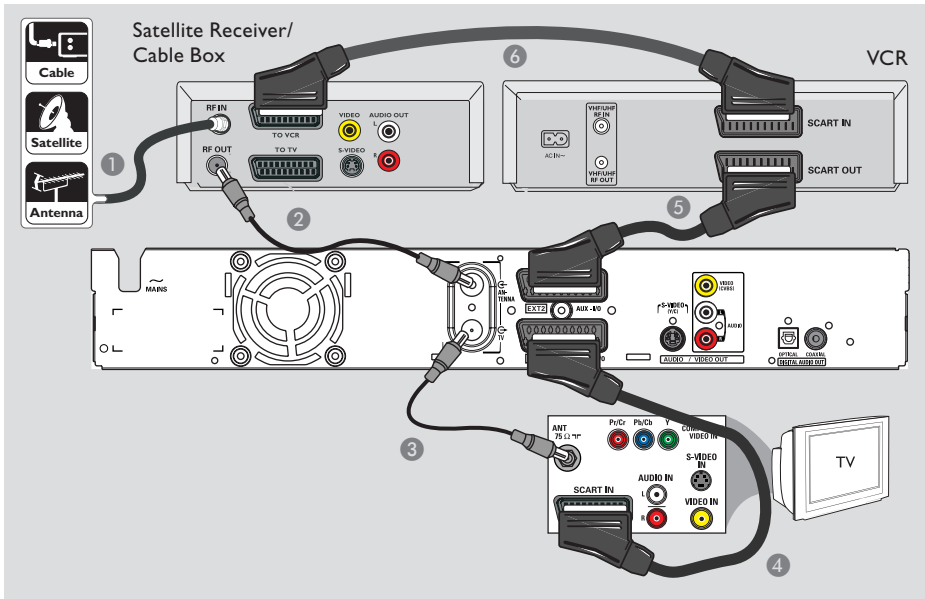

Connecting to a VCR and Cable Box/Satellite Receiver

- 1 Keep the existing antenna connection from the Cable Box/Satellite Receiver to your TV.
- 2 Use the supplied RF coaxial cable to connect the antenna output (RF OUT) socket on the Cable Box/Satellite Receiver to the **ANTENNA** socket on the recorder.
- 3 Use another RF coaxial cable to connect the **TV** socket on the recorder to the antenna input socket on the TV.
- 4 Use the scart cable to connect the **EXT1 TO TV-I/O** socket on the recorder to the corresponding SCART input socket on the TV.
- 5 Use another scart cable to connect the **EXT2 AUX-I/O** socket on the recorder to the Scart output socket (or labelled as TV OUT or TO TV) on the VCR.
- 6 Use another scart cable to connect the Scart input socket (or labelled as TV IN or TO DECODER) on the VCR to the Scart output socket (or labelled as TV OUT or TO VCR) on the Cable Box/Satellite Receiver.

TIPS: Refer to your optional connected devices' user manual for other possible connections.

Step 2: Optional Connections (continued)

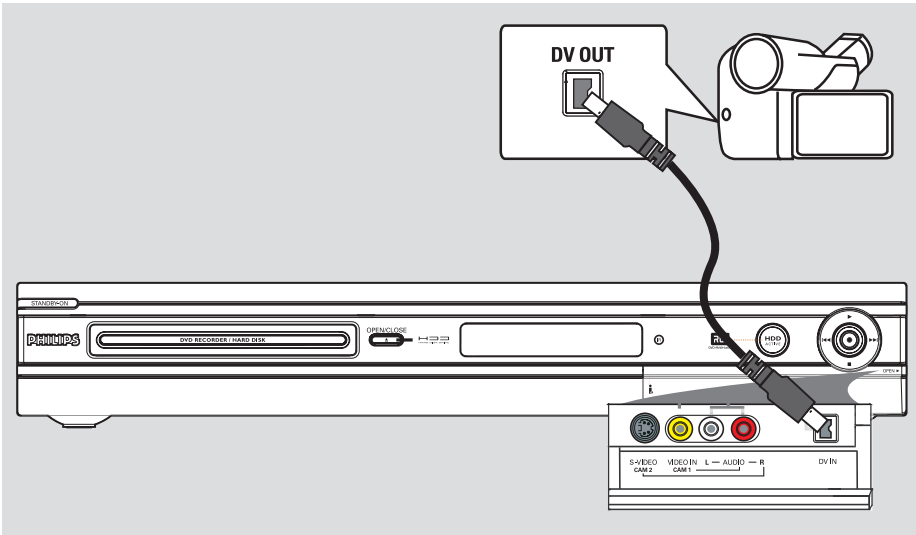

Connecting to a camcorder

You can use the front sockets to copy camcorder recordings. These sockets are located behind the flap on the right hand side which provides convenient connections for a camcorder.

Option 1: Using the DV IN socket

Use this connection if you have a Digital Video or Digital 8 camcorder. The DV socket conforms to the i.LINK standard. It provides the best picture quality.

- Use an i.LINK 4-pin cable (not supplied) to connect the **DV IN** socket on the recorder to the appropriate DV OUT socket on the camcorder.
 - ➔ Press **DV** on the remote control when using this input source.

Helpful Hints:

- You can also use the DV IN to connect this recorder to a Personal Computer that has a DV output socket. The PC must have an IEEE 1394 Firewire connector.
- It is not possible to record from this recorder to your camcorder via the DV IN socket on your recorder.

TIPS: Refer to your optional connected devices' user manual for other possible connections.

Step 2: Optional Connections (continued)

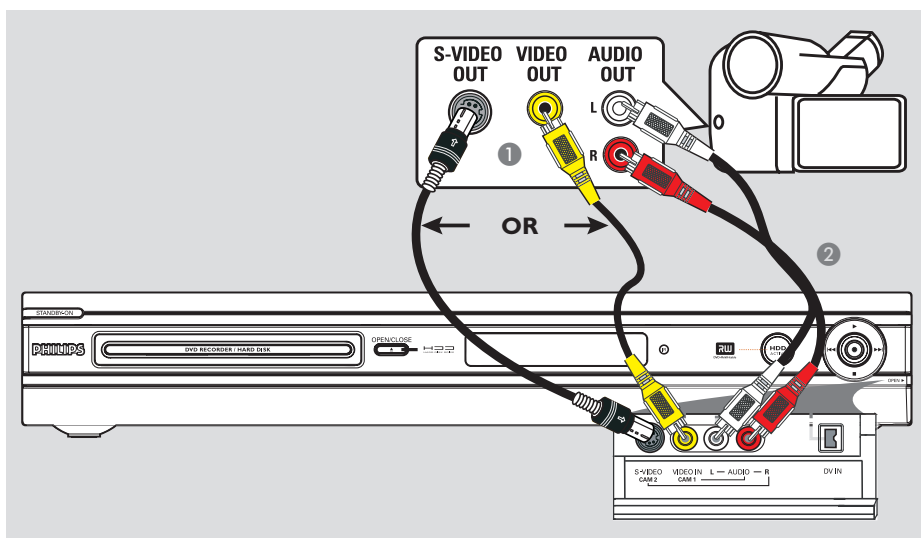

Option 2: Using the S-VIDEO In or VIDEO In socket

Use the S-VIDEO connection if you have a Hi8 or S-VHS(C) camcorder. It provides very good picture quality.

Alternatively, you can use VIDEO connection if your camcorder has only a single video output (Composite Video, CVBS). It provides good picture quality.

- 1 Connect the **S-VIDEO** socket at the front panel of the recorder to the corresponding S-VHS output socket on the camcorder.
→ Press **TUNER** followed by **CH +/—** on the remote control to select 'CAM 2' when using this input source.

OR

- Connect the **VIDEO** socket at the front panel of the recorder to the corresponding Video output socket on the camcorder.
→ Press **TUNER** followed by **CH +/—** on the remote control to select 'CAM 1' when using this input source.
- 2 Use an audio cable (red/white - not supplied) to connect the **AUDIO L/R** sockets at the front panel of the recorder to the audio output socket on the camcorder.

TIPS: Refer to your optional connected devices' user manual for other possible connections.

Step 3: Installation and Set-up

The basic installation menu will appear the very first time you turn on this recorder. These settings will help you set up the basic recorder features easily, including TV programme installation and language settings.

IMPORTANT!

Complete the basic installation settings before inserting a disc for playback or recording. The disc tray will not open until the basic setup is completed.

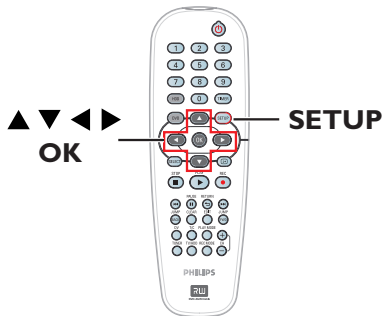

- 1 Press **STANDBY-ON**  to turn on the recorder.
- 2 Turn on the TV to the correct programme number for the recorder (e.g. 'EXT', '0', 'AV').
→ You may go to Channel 1 on your TV, then press the Channel down button on your TV's remote control until you see the menu appear on the TV.

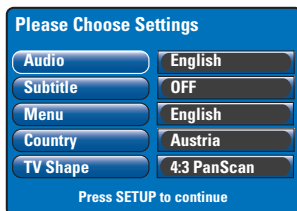

- 3 Use **▲▼** keys to select the options in the menu and press **OK** to access.
- 4 Use **▲▼** keys to select the desired setting and press **OK** to confirm.

{ Audio }

Select the audio language for DVD playback. If the preferred language is not available on the DVD, the default language will be used instead.

{ Subtitle }

Select the preferred subtitle language for DVD playback. If the preferred language is not available on the DVD, the default language will be used instead.

{ Menu }

Select the menu language for this recorder on-screen display.

{ Country }

Select your country of residence for auto channel tuning.

{ TV Shape }

Select the appropriate TV shape according to the TV you have connected.



16:9



4:3 Letterbox

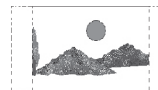

4:3 PanScan

- 5 Once complete, press **SETUP** on the remote control to continue.
→ A reminder to connect your aerial appears.

TIPS: After completing the basic installation, you can change or update your settings using the system setup menu, see page 56–61.

Step 3: Installation and Set-up (continued)

Note: Make sure you have successfully made all the required connections to this recorder, the TV and Satellite Receiver/ Cable Box (if any) and turned them on. The channel search will detect the signals and save all the available programme channels.

- 6 Press **OK** to start automatic channel install.
 - It takes a few minutes to complete.
 - The total number of found and stored channels appear.

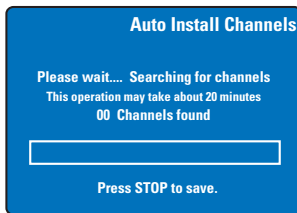

If no channels are found :

– Try the auto TV channel installation after completing the basic setup, see page 60.

- 7 After the channel search is finished, press **SETUP** to save.
 - The date and time menu appears.



- 8 The recorder will automatically detect the first available channel which is transmitting the date/time information.
 - If the information is incorrect, use ▲▼ keys to select another TV channel for auto clock preset function or select { **Off** } and set the date/time manually.
- 9 Confirm the date/time setting by pressing **SETUP** to save and exit.

The basic installation is now complete. This recorder is ready for use!

TIPS: After completing the basic installation, you can change or update your settings using the system setup menu, see page 56~61.

Control TV Programmes

Switching on to TV programme

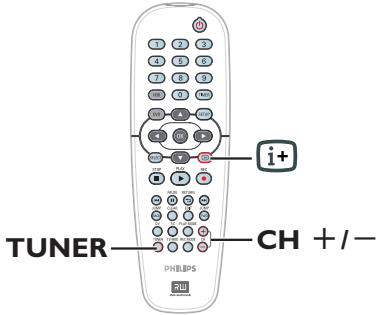

- 1 Turn on the TV to the correct programme number for the recorder (e.g. 'EXT', '0', 'AV').
- 2 Press **STANDBY-ON**  to turn on this recorder.
→ If no TV programme appears on the screen, press **TUNER** on the remote control.
- 3 Press **CH +/-** to select a TV channel.
→ The selected TV channel will appear on the status window.
→ The active TV programmes will be stored automatically onto the temporary HDD storage in this recorder. The information is shown on the Time Shift video bar.

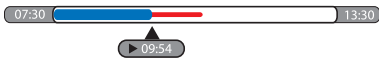

- You can choose to display or hide the Time Shift video bar by pressing **i+** key on the remote control.

For more information about the temporary HDD storage (Time Shift Buffer), see next page.

Pause live TV function

Sometimes, you might be interrupted when watching your favourite TV programme or match. Now, you can pause the show by pressing **PAUSE II** on the remote control and press **PLAY ►** to resume playback. It behaves exactly as if you were in control of the live broadcast.

If you want to return to the live TV programme, just press **TUNER**.

Instant Replay function

When watching a live TV programme, you can press **JUMP BACK** on the remote control to jump back 30 seconds upon every single press for instant replay.

If you want to return to the live TV programme, just press **TUNER**.

FlexTime function

You do not need to wait until the recording is completed before starting playback.

While the recording is in progress, press **◀◀** repeatedly on the remote control to go back to the beginning of the recording and start playback from there.

Before Recording

About temporary HDD storage/Time Shift video bar

As soon as you turn on this recorder, the currently selected TV programme will be stored in the temporary hard disk storage called '**TSB**' (Time Shift Buffer), up to 6 hours of programmes can be stored.

The Time Shift video bar will appear on the screen. It indicates the status and timing of the TV programmes stored in the temporary HDD storage. You can choose to display or hide the video bar by pressing the **i+** on the remote control.

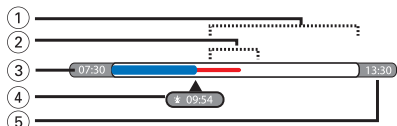
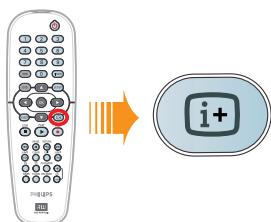

The Time Shift video bar consists of the following information:

- ① Remaining space in the temporary storage.
- ② Clips that are selected to be recorded onto the HDD (marked Red).
- ③ The TV programme start time.
Once it has exceeded 6 hours, the beginning of the contents will be deleted and the start time will be changed accordingly.
- ④ Current position and time of playback.
- ⑤ End time of the buffer.

WARNING!

The temporary HDD can only store up to six hours of TV programmes. All the contents will be cleared when you press **STANDBY-ON** to turn off the recorder.

In addition, executing the following actions will also clear the contents in the temporary HDD storage:

- Press **DV** or **REC MODE** on the remote control.
- Enter to { **Setup** } option in the setup menu.

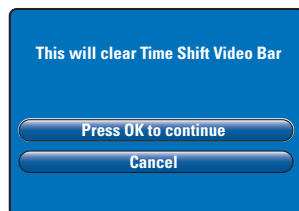

- i) To proceed and clear the contents in the temporary HDD storage, select { **Press OK to continue** } in the menu and press **OK** on the remote control, OR
- ii) Select { **Cancel** } in the menu and press **OK** on the remote control to abort.

If you want to keep the contents, you have to 'mark' the contents by pressing **REC ●** on the remote control at the beginning of the scene you wish to start recording and key in the total recording time required. The 'marked' contents will be recorded onto the HDD, see page 30.

Helpful Hint:

– You can only mark up to a maximum of 12 programmes in the TSB. If you try to press **REC** button again, { **TSB Recording Markings Full** } will be displayed.

Before Recording (continued)

Default recording settings

You can preset your recording settings in the recording system setup menu.

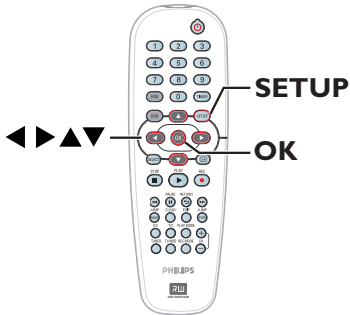

- 1 Press **SETUP** on the remote control.
→ The setup menu appears on TV.



- 2 Press ▼ to select { **Recording** } and press ► to access its options.



- 3 Use ▲▼ keys to select the setting you wish to change and press **OK** to access its options.
→ Instructions and explanation of the options are provided in the following pages.
→ If the selection in the menu is greyed out, that means the feature is not available or cannot be changed in the current state.
- 4 To exit, press **SETUP**.

Helpful Hint:

– The last selected recording mode will be used for all the recordings, including the timer recordings.

Before Recording (continued)

Recordings (underlined options are the factory default settings)

Record Mode

The recording mode defines the picture quality of recordings and the maximum recording time on the HDD (hard disk drive).
Important! When copying from HDD to a recordable DVD, the recording mode of the selected recording in the HDD will automatically be transferred. Selecting another recording mode is not possible.

Record Mode	Hours of recordings can be stored on the HDD or an empty 4.7GB DVD recordable disc.			
	DVDR3300H HDD (80GB)	DVDR3330H HDD (160GB)	DVDR5330H HDD (250GB)	DVD±R/ DVD±RW
HQ (high quality)	16	30	50	1
SP (standard play)	32	60	100	2
SPP (standard play plus)	40	80	120	2.5
LP (long play)	48	90	150	3
EP (extended play)	64	120	200	4
SLP (super long play)	96	180	300	6
SEP (super extended play)	130	250	400	8

Note: Changing the Recording Mode and Filter mode will clear the contents in the temporary HDD storage. Only the marked contents (in red bar) will be recorded onto the hard disk drive (HDD) of this recorder.

Filter Mode

For long play or extended play recording, you can select a suitable filter mode to optimise the video recording. The setting does not influence high quality or standard play recording mode.

- { **Standard** } – Recording quality is same as the recording mode selected.
- { **Sport** } – Improves the recording quality for fast movement images in LP/EP/SLP/SEP recording mode.

Auto Chapters

Automatically divides a recording (title) into chapters by inserting chapter markers at a specific interval. This enables you to access a specific point in the recording quickly.

- { **Off** } – No chapter marker will be inserted in the recording.
- { **On** } – Chapter markers will be inserted during recording at every five minutes interval.

SAT Record

This feature is only available if you have connected a Satellite Receiver or other devices to the EXT 2 AUX-I/O scart socket of this recorder, see page 31 for more information.

- { **Off** } – Turns off the function.
- { **EXT2** } – Enables this recorder to start and stop recording when a signal is received from the connected device.

Dual Language

Selects the recording language to be used for TV programmes which are transmitted additional audio language. For example, if a programme is available in English and Spanish, with Spanish being the additional language option.

- { **Language 1** } – Original broadcast language.
- { **Language 2** } – Additional audio language.

Record on Hard Disk

IMPORTANT!

Unrecordable pictures

Pictures with copy-protection cannot be played back from the HDD or copied to a recordable DVD.

Recording TV programmes

Follow the instructions below to record the TV programmes onto the HDD, where you can store for future viewing and copy to a recordable DVD disc if required.

- 1 Press **i+** on the remote control to display the Time Shift Video bar.
- 2 Use **◀▶** keys to search for the beginning of the scene in the temporary HDD storage where you want to start recording, then press **PAUSE II**.
- 3 Press **REC ●** on the remote control.
→ The video bar changes to recording time input field.



- 4 Press **REC ●** repeatedly to increase the recording time in 30-minute increments, up to a maximum of six hours.
- Alternatively, you can use the **numeric keypad 0-9** on the remote control to input the recording time.
→ A red marking will be visible on the video bar to indicate the marked recording.
- 5 Press **PLAY ▶** to continue playback.
- 6 To stop the recording before the scheduled ending, press **STOP ■** or turn off the recorder.
- To delete the recording, press **CLEAR**.

TIPS: Set the appropriate recording mode for HDD recording. The same recording mode will be used for recording from HDD to a recordable DVD, see page 29.

Simultaneous record and play function

While recording the TV programme to the HDD is in progress, you can play a previously recorded title from the HDD, or play a DVD video disc, or watch the playback from other connected devices.

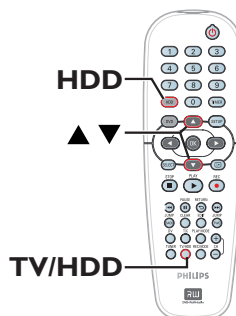

Playback from HDD

- Press **HDD**, use **▲▼** keys to select a title in the HDD content menu and press **OK** to start playback.

Playback from DVD

- Press **OPEN CLOSE** on the recorder's front panel and load in a disc to start playback.

Playback from other device

This is only possible if this recorder is connected to the TV using the EXT1 TO TV-I/O socket.

- Press **TV/HDD** to view the picture from the device which is connected to the EXT2 AUX-I/O socket of this recorder.

Record on Hard Disk (continued)

Watching other TV programmes

If there is no device connected to the EXT2 AUX-I/O socket, pressing **TV/HDD** will switch to the TV mode.

- Use the TV's channel up/down button to select a different TV channel.

Helpful Hint:

– Remember to turn the TV back to its video input channel if you want to watch the TV channel through the recorder or play back the recorded disc.

Automatic recording from a Satellite Receiver

This feature is only applicable for the Satellite Receiver (or any similar devices) that is connected to the EXT2 AUX-I/O scart socket of this recorder. In addition, the Satellite Receiver must have a timer function that is able to control the recording function of this recorder.

- ① Ensure that the { **Sat Record** } mode in the recording setting is set to { **EXT2** }, see page 29.
- ② Use the Satellite Receiver's timer programming function to programme the recording (refer to the Satellite Receiver's user manual).
- ③ Leave the recorder and Satellite Receiver in standby mode for the recording.
→ The recorder will start recording when it detects a signal from the Satellite Receiver.

TIPS: Set the appropriate recording mode for HDD recording. The same recording mode will be used for recording from HDD to a recordable DVD, see page 29.

Record on Hard Disk (continued)

Recording from a DV camcorder

Using this feature, you can record video directly from a connected DV camcorder onto the HDD, where you can edit it easily and copy to a recordable DVD if required.

IMPORTANT!

Before starting camcorder recording, mark the contents in the temporary HDD storage for which you wish to record to the HDD.

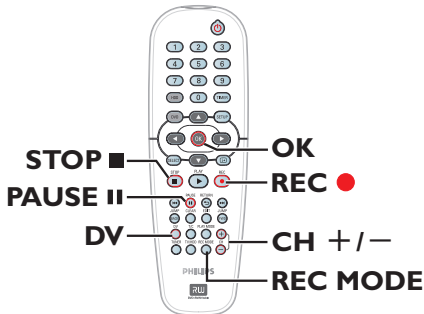

- 1 Connect the DV camcorder to the **DV IN** socket at the front panel of this recorder (see page 22).
- 2 Find the place on the DV camcorder that you want to start recording from and set the camcorder to pause mode.
- 3 Turn on the TV to the correct programme number for the recorder (e.g. 'EXT', '0', 'AV').
- 4 Turn on the recorder and press **DV** on the remote control.

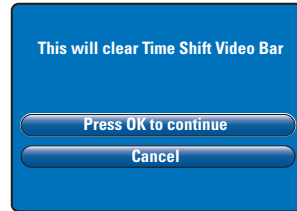

- 5 A warning message will appear on the screen. Select { **Press OK to continue** } in the menu and press **OK** to confirm.
 - All the contents in the temporary HDD storage will be cleared except for the 'marked' (in red) contents.
- Otherwise, select { **Cancel** } in the menu and press **OK** to abort the camcorder recording operation.
- 6 Press **REC MODE** to select a suitable recording mode, see page 29 for more information.
- 7 Press **REC ●** to start recording and press **PLAY** button on the DV camcorder to start playback.
- To pause the recording, press **PAUSE II**. To continue recording, press **REC ●**.
 - A new chapter marker is created after recording restarts.
- 8 To stop the recording, press **STOP ■**.
- 9 To end the camcorder operation, press **DV** again.

Helpful Hint:

– Scheduled recordings will not be carried out whilst the recorder is in camcorder operating mode.

TIPS: Set the appropriate recording mode for HDD recording. The same recording mode will be used for recording from HDD to a recordable DVD, see page 29.



Record on Hard Disk (continued)

Recording from an external device (Camcorder/VCR/DVD player)

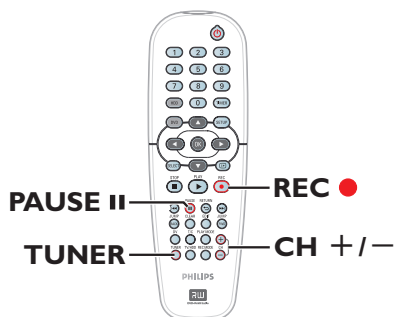
You can record from an external device which is connected to this recorder's input socket. Copy-protected material cannot be recorded on this recorder.



- 1 Connect the external device to this recorder (see page 20, 23).
- 2 Turn on the TV to the correct programme number for the recorder (e.g. 'EXT', '0', 'AV').
- 3 Press **STANDBY-ON**  to turn on the recorder.
→ If no TV programme appears on the screen, press **TUNER** on the remote control.

- 4 Press **CH +/-** repeatedly to select the correct input channel that matches the connected socket of the device.
→ { EXT 1 } : EXT 1 TO TV-I/O Scart socket at the back.
→ { EXT 2 } : EXT 2 AUX-I/O Scart socket at the back.
→ { CAM 1 } : VIDEO socket at the front.
→ { CAM 2 } : S-VIDEO socket at the front.
- 5 Press **REC**  and use the **numeric keypad 0-9** on the remote control to input the total recording time.
→ You can also press **REC**  repeatedly to increase the recording time in 30-minute increments.
- 6 Start playback on the connected device.
- 7 To stop the recording, press **STOP** .

TIPS: Set the appropriate recording mode for HDD recording. The same recording mode will be used for recording from HDD to a recordable DVD, see page 29.

Record on Hard Disk (continued)

About timer recording

Use the timer recording to automatically start and stop a recording at a later date/time. This recorder will tune to the right programme channel and begin recording at the specified time.

With this recorder, you can programme up to **8 recordings** at a time. During timer recording, changing the recorder's channel is not possible.

To make a timer recording, your recorder needs to know:

- The date you want to make the recording.
- The recording input source.
- The start and stop time of the recording.

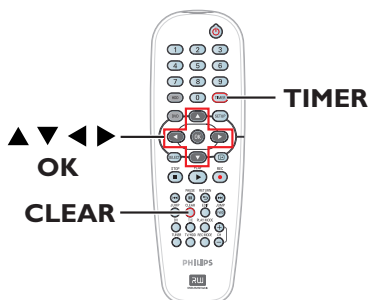

About 'VPS/PDC'

'VPS' (Video Programming System) or 'PDC' (Programme Delivery Control) is used to control the start and duration of TV channel recordings. If a TV programme starts earlier or ends later than was scheduled, this recorder will then turn on and off at the correct time.

VPS/PDC is intended to record the entire programme. To set a time that is longer/shorter than the VPS/PDC broadcast time, you must turn off the VPS/PDC.

TIPS: Set the appropriate recording mode for HDD recording. The same recording mode will be used for recording from HDD to a recordable DVD, see page 29.

Timer recording (SHOWVIEW® System)

This is a simple timer programming system. To use it, enter the SHOWVIEW® programming number associated with your television programme. You can find this number in your TV listings magazine.

All the information needed by this recorder for programming is contained in the programming number.

- 1 Turn on the TV to the correct programme number for the recorder (e.g. 'EXT', '0', 'AV').
- 2 Turn on the recorder and press **TIMER** on the remote control.
 - The timer menu appears.

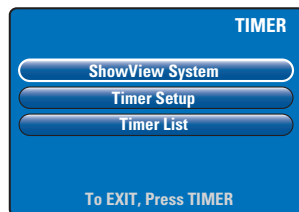

- 3 Select { **SHOWVIEW® System** } in the menu and press **OK**.
 - The SHOWVIEW® entry menu appears.

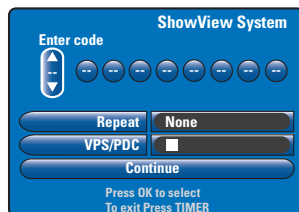

Record on Hard Disk (continued)

- 4 Use the **numeric keypad 0-9** to enter the SHOWVIEW® programming number. (e.g.: 5-312-4 or 5,312 4, key in '53124').
→ Use ◀ ▶ keys to move to the previous/next entry field.
- Press **CLEAR** on the remote control will clear the ShowView entry
- 5 The default recording settings for record mode, repeat setting and VPS/PDC are used. To make changes, move to the respective field in the menu.

{ Repeat }

Press **OK**, use ▲ ▼ keys to select the repeat recording setting (None, Mo~Fr, Weekly) and press **OK** again to confirm.

{ VPS/PDC }

Press **OK** to activate () or deactivate () the VPS/PDC setting, see page 34 for more information.

- 6 Once complete, select { **Continue** } in the menu and press **OK**.
→ The timer setup menu appears.

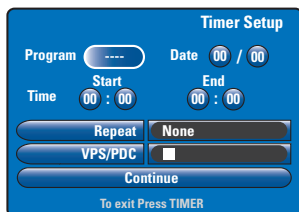

- 7 If the programme information is correct, select { **Continue** } in the menu and press **OK**.
- Otherwise, move to the respective field and change the timer programme information manually.

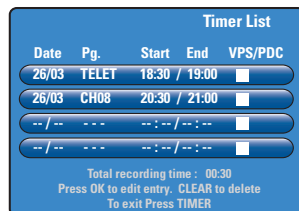

- 8 Press **TIMER** to confirm and exit the menu.
→ The 'TIMER' icon will light up on the display panel if a timer recording is set.
→ If the recorder is not in standby mode, a notification message will appear before the timer recording begins. If you ignore the message, the timer recording will not start unless you have switched to the respective channel.

TIPS: Set the appropriate recording mode for HDD recording. The same recording mode will be used for recording from HDD to a recordable DVD, see page 29.

Record on Hard Disk (continued)

Timer recording (manually)

- 1 Turn on the TV to the correct programme number for the recorder (e.g. 'EXT', '0', 'AV').
- 2 Turn on the recorder and press **TIMER** on the remote control.
→ The timer menu appears.

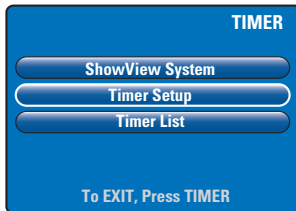

- 3 Select { **Timer Setup** } in the menu and press **OK**.
→ The timer setup menu appears.

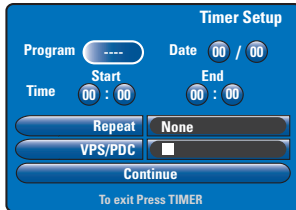

- 4 Use **▲▼** keys or the **numeric keypad 0-9** to select or enter the recording information.
→ Use **◀▶** keys to move to the previous/next entry field.

{ Programme }

Select the TV channel or the correct external input (EXT1, EXT2, CAM1 or CAM2) if you want to make the recording from an external connected device.

{ Date }

Enter the date for recording (Day/Month).

{ Time-Start }

Enter the start time of recording (hours : minutes).

{ Time-End }

Enter the end time of recording (hours : minutes).

{ Repeat }

Press **OK**, use **▲▼** keys to select a desired repeat recording setting (None, Mo-Fr, Weekly).

{ VPS/PDC }

Press **OK** to activate () or deactivate () the VPS/PDC setting, see page 34 for more information.

- 5 Once complete, select { **Continue** } in the menu and press **OK**.
→ The timer list menu appears.

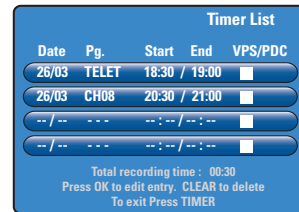

- 6 Press **TIMER** to confirm and exit the menu.
→ The '**TIMER**' icon will light up on the display panel if a timer recording is set.
→ If the recorder is not in standby mode, a notification message will appear before the timer recording begins. If you ignore the message, the timer recording will not start unless you have switched to the respective channel.

TIPS: Set the appropriate recording mode for HDD recording. The same recording mode will be used for recording from HDD to a recordable DVD, see page 29.

Record on Hard Disk (continued)

Changing/Deleting a timer recording

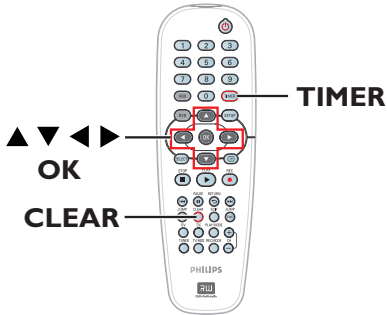

- 4 Use ▲▼ keys to select a timer programme which you want to delete/change.
- To change the timer entry, press **OK** to return to the entry menu.
- To cancel the timer programming, press **CLEAR**.
- 5 Once complete, press **TIMER** to confirm and exit the menu.

- 1 Turn on the TV to the correct programme number for the recorder (e.g. 'EXT', '0', 'AV').
- 2 Turn on the recorder and press **TIMER** on the remote control.
→ The timer menu appears.



- 3 Select { **Timer List** } in the menu and press **OK**.
→ The timer list menu appears.

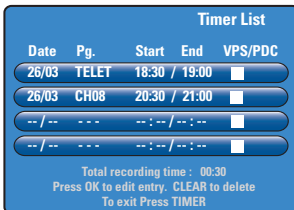

TIPS: Set the appropriate recording mode for HDD recording. The same recording mode will be used for recording from HDD to a recordable DVD, see page 29.

Record on DVD Recordable Disc

IMPORTANT!

- You can only copy the recorded titles in the hard disk drive of this recorder to a recordable DVD. Direct recording from the TV programmes or external input source to a recordable DVD is not possible.
- Copy-protected (Copy-Once or Copy-Never) movies and DVD Videos cannot be copied to the HDD.

About copying

You can copy a recorded title from the HDD (hard disk drive) to a recordable DVD.

The time required for copying from HDD to a recordable DVD depends on the recording mode of the HDD recordings. It is not possible to change the recording mode for the copying process. It is therefore important that you choose the appropriate recording mode when you set up the recording to the HDD.

The copying process is done at a higher speed than the recording.

HDD → Recordable DVD

HDD Recording Mode	Hours of recordings can be stored in a 4.7GB DVD±R/±RW
HQ (high quality)	1
SP (standard play)	2
SPP (standard play plus)	2.5
LP (long play)	3
EP (extended play)	4
SLP (super long play)	6
SEP (super extended play)	8

The following information will be stored on the disc :

- Recording mode
- Title/name of recording
- Date and time of recording
- Index picture of title

TIPS: Ensure that there is sufficient space available on the recordable DVD before recording. You have to finalise the DVD±R before it can be played on other players, see page 53.

Discs for recording

Two different types of DVD recordable discs can be used with this recorder:



DVD±RW (DVD Rewritable)

- Discs that are re-writable can be used for multiple recordings once existing data is erased.



DVD±R (DVD Recordable)

- Discs can only be used for a single recording. Each new recording is always added at the end of all previous recordings as existing recordings cannot be overwritten.
- Editing can be done on DVD±R discs as long as they have not been finalised.
- You can also delete unwanted recordings. However, the disc space occupied by the deleted recordings cannot be recovered for further recording.
- To play a DVD±R disc on other DVD player, it must be finalised (see page 53). After this is done, no more data can be added to the disc.

Record on DVD Recordable Disc (continued)

Recording to a recordable DVD

You can choose any recordings from the HDD that you wish to copy to a recordable DVD. The storage capacity of the disc depends on the recording mode that was selected for the recordings in the HDD, see page 38.

Before you start...

Be sure that no other recording is to be carried out while copying (e.g. timer recording).

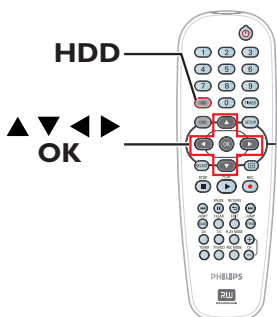

- 1 Turn on the TV to the correct programme number for the recorder (e.g. 'EXT', '0', 'AV').
- 2 Insert a recordable DVD into the recorder.
- 3 Press **HDD** on the remote control.
→ The overview of all recordings on the HDD appears.



- 4 Use ▲▼ keys to select a title to copy and press ► to display the edit title menu.

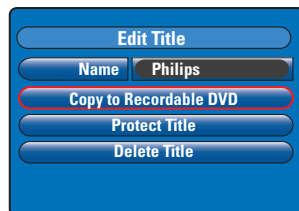

- 5 Press ▼ to select { **Copy to Recordable DVD** } in the menu and press **OK**.

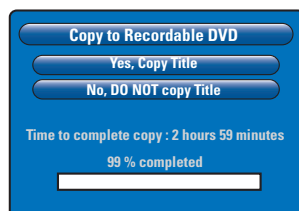

- 6 Select { **Yes, Copy Title** } in the menu and press **OK** to proceed.
→ Otherwise, select { **No, DO NOT copy Title** } and press **OK** to exit.
→ While copying the recordings from HDD, any interruption to the process (e.g. power failure) may lead to a bad disc.
- The recorder will switch to tuner mode while copying and return to the menu again once the recording is completed.
→ To check the copying progress, press **i+** on the remote control.

Helpful Hint:

– In some cases, you may not be able to add new recording to a recordable DVD that contains recordings from other DVD recorders.

To edit your recordings on the recordable DVD, see pages 51~55.

TIPS: Ensure that there is sufficient space available on the recordable DVD before recording. You have to finalise the DVD±R before it can be played on other players, see page 53.

Playback from Hard Disk

Basic operation

Each recording stored on the HDD is displayed in the HDD browser with an index picture.

- 1 Press **HDD** on the remote control.
→ The HDD content menu appears.



- 2 Use **▲▼** keys to select a title and press **OK** to start playback.
- If power failure occurred during the process of recording, the partially recorded content will be displayed as { recovered title } in the HDD content menu.
- 3 During playback, you can use the following buttons on the remote control to access additional playback features.

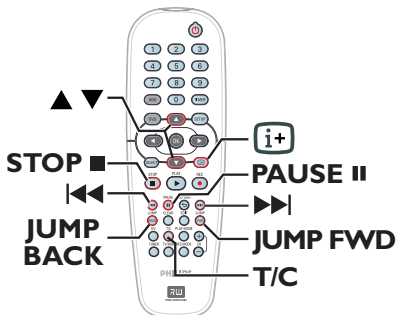

- move to the beginning or previous/next chapter.
- holding down this button to start fast backward/forward search. Press the button again will increase the search speed (x4, x8, x16, x32).
- while in pause mode, start slow motion playback.

JUMP BACK/JUMP FWD

- jump backward/forward by 30 seconds

PAUSE II

- view a still picture.

T/C

- access various additional playback features, see pages 45–47.

STOP ■

- stop playback.

TIPS: Press **HDD** to exit the menu.

Playback from Disc

Playable discs

Using this recorder, you can play and record on the following discs:

Recording and Playback

DVD±RW (DVD Rewritable); can be recorded on over and over and can only be played back when the recording was made in 'video mode'.



DVD±R (DVD Recordable); once the disc is full or finalised, you cannot record any more on the disc. It can only be played back when the recording was made in 'video mode' and finalised.



Playback only:

DVD Video (Digital Versatile Disc)



Audio CD (Compact Disc Digital Audio)



Video CD
(Formats 1.0, 1.1, 2.0)



Super Video CD



CD-R (CD-Recordable)
Audio/ Video format or MP3/JPEG files.



CD-RW (CD-Rewritable)
Audio/Video format or MP3/JPEG files.







IMPORTANT!

– If the inhibit icon  appears on the TV screen when a button is pressed, it means the function is not available on the current disc or at the current time.

– DVD discs and players are designed with regional restrictions. Before playing a disc, make sure the disc is for the same region zone as your player.

Starting disc playback

- 1 Press **STANDBY-ON**  to turn on the recorder.
- 2 Press **OPEN CLOSE**  on the front of the recorder.
 - You can also hold down the **STOP**  button on the remote control to open and close the disc tray.
- 3 Carefully place the disc into the tray with the label facing up, then press **OPEN CLOSE** .
 - For double-sided discs, load the side which you want to play facing up.
- 4 Turn on the TV to the correct programme number for the recorder (e.g. 'EXT', '0', 'AV').
- 5 Playback may start automatically. If not, press **PLAY** .
 - If the pin code entry dialogue appears on the TV, this means that the child lock/parental control was activated for the inserted disc. You have to enter your four-digit pin code (see page 59).
 - For more playback features, see pages 44–47.

TIPS: Some discs cannot be played on this DVD recorder due to the configuration and characteristics of the disc, or due to the condition of recording and authoring software that was used.

Playback from Disc (continued)

Playing a DVD video disc

Normally the DVD disc contains a disc menu. You may have to make your selection (e.g., subtitle or audio language) within the disc menu.

- 1 Insert a DVD.

To access the disc menu

- Press **DVD** on the remote control. Use the **numeric keypad 0-9** to input your selection or use **▲▼** keys to select a play option and press **OK** to confirm.

To select the previous or next chapter/title

- During playback, press **T/C** on the remote control. Select { **Title** } or { **Chapter** } in the menu and enter the required title or chapter number.
- 2 To stop playback, press **STOP ■**.

Playing a (Super) Video CDs

(Super) Video CDs may feature 'PBC' (Play Back Control). This allows you to play the video CDs interactively, following the menu on the display.

- 1 Insert a (Super) Video CD.

If the disc index menu appears

- 2 Use **numeric keypad 0-9** to input your selection or use **▲▼** keys to select a play option and press **OK** to confirm.
- Press **RETURN** on the remote control to return to the previous menu.
- 3 To stop playback, press **STOP ■**.

Playing a DVD recordable disc

- 1 Insert a DVD recordable disc.
→ The Index Picture screen appears.
- 2 Use **▲▼** keys to select a title and press **PLAY ▶**.
- 3 To stop playback, press **STOP ■**.

Helpful Hint:

– If the message 'EMPTY DISC' appears on the display panel, this means that there are no recordings on this disc.

Playing an MP3 CD

MP3 (MPEG1 Audio Layer-3) files are highly compressed music files. The MP3 format lets you store about 10 times more data (music, pictures) on a single CD-ROM than a regular CD.

- 1 Insert an MP3 CD.
- 2 Press **T/C** on the remote control, select { **Album** } or { **Track** } in the menu and press **▶** repeatedly to select the album number and/or the track number to play.
- 3 During playback, you can press **◀◀ / ▶▶** to select the next/previous track.
- 4 To stop playback, press **STOP ■**.

Helpful Hints:

– Only the first session of a multi-session CD will be played back.
– Further information on the album, track and artist will also be displayed on the TV if this is included in the ID tag.
– This recorder does not support MP3PRO audio format.

TIPS: Some discs cannot be played on this DVD recorder due to the configuration and characteristics of the disc, or due to the condition of recording and authoring software that was used.

Playback from Disc (continued)

Playing a picture disc (slide show)

You can display JPEG pictures in the selected roll automatically one after the other at adjustable intervals.

- 1 Insert a JPEG picture disc (CD, DVD±RW, DVD±R).
→ The photo thumbnails menu with first nine images from the selected roll folder will appear.

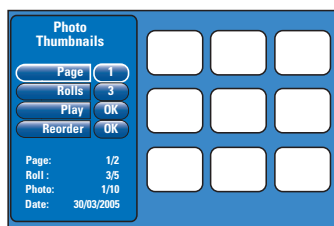

- 2 Use ▲▼ keys to select the following options.

{ Page }

Use the **numeric keypad 0-9** to enter the page number. The thumbnails images will change accordingly. Up to 99 pages are viewable.

{ Rolls }

Use the **numeric keypad 0-9** to enter the roll folder number. Up to 99 folders are viewable.

{ Play }

Select this and press **OK** on the remote control to start the slideshow playback.

{ Reorder }

Re-arrange the sequence of the photos to create the desired slideshow playback order.

Select this and press **OK** to enter the thumbnails view area.

Select a photo to move and press **OK**. A green bar appears at the left hand side of the photo. Move to the desired position and press **OK** again to insert the photo before the position.

To cancel the action, press **STOP**.

To return to the thumbnails menu, press ◀.

- To hide/unhide the pictures in a slideshow, select the picture in the thumbnails menu and press **STOP**.
- 3 During slideshow playback, you can press **T/C** on the remote control to edit the displayed photo. However, the changes cannot be stored on the HDD or disc.

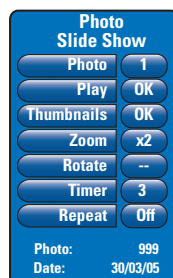

{ Photo }

Show the current photo number. Up to 999 files are viewable.

{ Play }

Select this and press **OK** on the remote control to start the slideshow playback.

{ Thumbnails }

Select this and press **OK** to return to the photo thumbnails menu.

{ Zoom }

Select this and press **OK** to enlarge the picture by changing the zoom factor (x1, x2, x4, x8). Use ◀▶▲▼ keys to pan through the zoomed picture.

{ Rotate }

Select this and press **OK** to change the picture orientation.

{ Timer }

Select this and press **OK** to change the slideshow interval from 1 to 99 seconds.

{ Repeat }

Select this to turn on/off the repeat play mode.

- 4 To stop playback, press **STOP**.

TIPS: Some discs cannot be played on this DVD recorder due to the configuration and characteristics of the disc, or due to the condition of recording and authoring software that was used.

Additional Playback Features

Searching forwards/backwards

You can fast forward or fast reverse a disc during playback and select a desired search speed.

- 1 During playback, hold down **◀◀** (reverse) or **▶▶** (forward) until the search speed status bar appears on the TV.
→ The sound will be muted.
- 2 Press the **◀◀** (reverse) or **▶▶** (forward) repeatedly to cycle through the different search speed (4X, 8X, 16X, 32X).
- 3 To resume normal playback, press **▶**.

Using the Play Mode options

The Play Mode button on the remote control provides the options for repeat play, random play and scan mode.

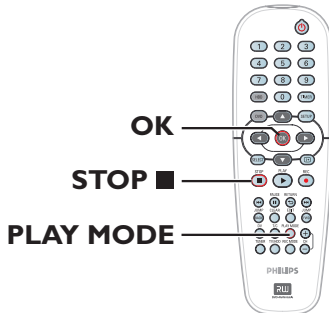

- 1 During disc playback, press **▶** repeatedly on the remote control to toggle between :
 - Repeat chapter (DVD, DVD±R/±RW only)
 - Repeat title/track
 - Repeat disc (DVD, VCD, CD only)
 - Repeat A-B
 - Shuffle
 - Scan

- 2 To stop the play mode, press **■** on the remote control or press **▶** until no display appears on the status box.

{ Repeat Chapter }

Select this to repeat playback of the current chapter (DVD, DVD±R/±RW only).

{ Repeat Track/Title }

Select this to repeat playback of the current track/title.

{ Repeat Disc }

Select this to repeat playback of the entire disc (DVD, VCD, CD only).

{ Repeat A-B }

Select this to repeat the playback of a specific segment within a title/chapter/track. Press **OK** to mark the start and end of the segment you want to repeat.

{ Shuffle }

Select this to randomly play back all the tracks within the disc (DVD, MP3 and audio CD only).

{ Scan }

Select this to play the first 10 seconds of each chapter/track.

TIPS: The operating features described here might not be possible for certain discs. Always refer to the instructions supplied with the discs.

Additional Playback Features (continued)

Using the T/C options

You can have a quick access to various additional playback features by using the T/C tools menu.

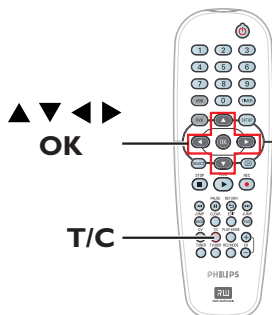

- 1 During playback, press **T/C** on the remote control.
→ The T/C menu options might differ depending on the situation and disc type.

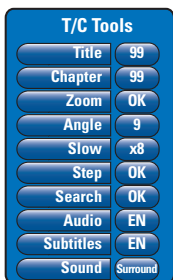

- 2 Use **▲▼** keys to select an option in the menu.
→ Instructions and explanation of the options are provided in the following pages.
→ If the selection in the menu is greyed out, that means the feature is not available or cannot be changed in the current state.
- 3 To exit, press **SETUP**.
→ Otherwise, the T/C menu will exit automatically after a few seconds.

Selecting a title/chapter

- 1 During playback, press **T/C** on the remote control.
→ The T/C menu appears.
- 2 Use **▲▼** keys to select { **Title** } or { **Chapter** }, and use the **numeric keypad 0-9** to enter the title or chapter number.

Zooming in

This option allows you to enlarge the picture on the TV screen and to pan through the enlarged picture.

- 1 During playback, press **T/C** on the remote control.
→ The T/C menu appears.
- 2 Use **▲▼** keys to select { **Zoom** } and press **OK** on the remote control to enter zoom in mode.
- 3 Press **OK** repeatedly to toggle through the supported zoom factor (x1, x1.3, x2, x4).

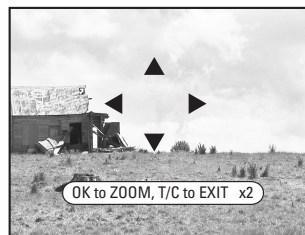

- 4 Use **◀▶▲▼** keys to pan around the zoomed picture.
- 5 To return to the normal display, press **OK** repeatedly until 'x1' appears.

TIPS: The operating features described here might not be possible for certain discs. Always refer to the instructions supplied with the discs.

Additional Playback Features (continued)

Switching camera angles

This option is only available with DVDs that contain sequences recorded from different camera angles. This allows you to view the picture from different angles.

- 1 During playback, press **T/C** on the remote control.
→ The T/C menu appears.
- 2 Use **▲▼** keys to select { **Angle** } and press **OK** to enter its options.
→ The available camera angles for selection appear.
- 3 Use **▲▼** keys to select the camera angle you want to switch to, then press **OK** to confirm.

Switching to slow motion play

You can select the playback speed for various slow motion modes available.

- 1 During playback, press **T/C** on the remote control.
→ The T/C menu appears.
- 2 Use **▲▼** keys to select { **Slow** } and use **◀▶** keys to select a required speed.

OR

- 1 During playback, press **PAUSE II** to pause playback and display a still picture.
- 2 Hold down **◀◀** (reverse) or **▶▶** (forward) to start reverse or forward slow motion playback.
→ Press **◀◀** or **▶▶** repeatedly to switch between different slow motion speed (-1/8, -1/4, -1/2, 1/8, 1/4 or 1/2).
- 3 To resume normal playback, press **PLAY ▶**.

Switching to step playback

This option allows you to play back the picture frame-by-frame.

- 1 During playback, press **T/C** on the remote control.
→ The T/C menu appears.
- 2 Use **▲▼** keys to select { **Step** } and press **◀▶** keys repeatedly to start backward or forward step playback.

Searching by time

This option allows you to skip to a specific point in the current disc.

- 1 During playback, press **T/C** on the remote control.
→ The T/C menu appears.
- 2 Use **▲▼** keys to select { **Search** } and press **OK** to display the time field.
→ Playback will pause.
→ The time shows the elapsed playing time of the current disc (hours: minutes).
- 3 Use the **numeric keypad 0-9** to enter the time where playback should start and press **OK** to confirm.
→ Playback skips to the time entered.

TIPS: The operating features described here might not be possible for certain discs. Always refer to the instructions supplied with the discs.

Additional Playback Features (continued)

Changing the audio soundtrack language

This operation works only on DVDs with multiple soundtrack language or VCDs with multiple audio channels.

- 1 During playback, press **T/C** on the remote control.
→ The T/C menu appears.
- 2 Use **▲▼** keys to select { **Audio** } and use **◀▶** keys to select the available audio language.
→ The languages may be numbered or abbreviated, such as “en” for English.
→ For VCD, it will toggle between LL, LR and RR, by which audio is heard from left, both or right channel respectively.

Helpful Hint:

– Some DVDs allow soundtrack language changes only via the DVD disc menu. To access the Disc Menu, press **DVD** on the remote control.

Changing subtitle language

This operation works only on DVDs with multiple subtitle languages. You can change to the language you want while playing the DVD.

- 1 During playback, press **T/C** on the remote control.
→ The T/C menu appears.
- 2 Use **▲▼** keys to select { **Subtitle** } and use **◀▶** keys to select the available subtitle language.
→ The languages may be numbered or abbreviated, such as “en” for English.

Helpful Hint:

– Some DVDs allow subtitle language changes only via the DVD disc menu. To access the disc menu, press **DVD** on the remote control.

Selecting sound mode

This operation works only on discs recorded with various sound modes (e.g. digital surround).

- 1 During playback, press **T/C** on the remote control.
→ The T/C menu appears.
- 2 Use **▲▼** keys to select { **Sound** } and press **OK** to enter its options.
- 3 Use **◀▶** keys to select { **Stereo** } or { **Surround** } and press **OK** to confirm.

TIPS: The operating features described here might not be possible for certain discs. Always refer to the instructions supplied with the discs.

Edit Recordings - HDD

Using the HDD edit title menu

In the HDD edit title menu, you can change the title name, set title protection, delete title, or copy the title to a recordable DVD.

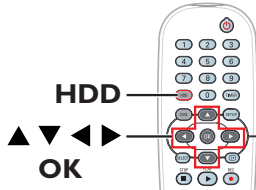

- 1 Press **HDD** on the remote control.
→ The HDD content menu appears.



- 2 Use **▲▼** keys to select a title and press **▶** to display the HDD edit title menu.

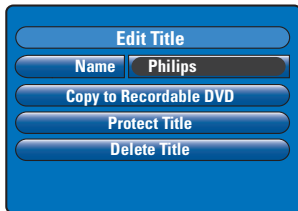

- 3 Use **▲▼** keys to access different options in the menu and press **OK** to select.
→ Instructions and explanation of the options are provided in the following pages.
- 4 To exit the HDD edit title menu, press **◀**.

Changing the title name

Some TV channels transmit the name of the programme. In this case, the programme name will automatically be stored when recording to the HDD. Otherwise, only the programme number and date/time of the recording will be stored as title name.

- 1 In HDD edit title menu, select { **Name** } and press **OK**.
- 2 Use **▲▼** keys to change the character/number.
→ Use **◀▶** keys to move to the previous or next field.
- To switch between upper and lower case characters, press **SELECT** on the remote control.
- To delete the character/number, press **CLEAR** on the remote control.
- 3 Press **OK** to confirm the changes and press **◀** to exit.

Protecting the title (recording)

You can protect the title to prevent the recording from being accidentally erased or edited.

- In HDD edit title menu, select { **Protect Title** } and press **OK**.
- To remove the protect feature**
- 1 In the HDD content menu, select the title and press **▶** on the remote control.
 - 2 Select { **Unprotect Title** } in the menu and press **OK**.

TIPS: No editing can be carried out on a protected title.
Press **◀** to go back to the previous menu item. Press **HDD** to exit the menu.

Edit Recordings - HDD (continued)

Deleting a title from HDD

If the space in the hard disk drive (HDD) is full, you must delete some titles on the HDD to make space for new recordings.

- Use ▲▼ keys to select a title and press **CLEAR** on the remote control.

OR

- 1 In HDD edit title menu, select { **Delete Title** } and press **OK**.
→ A warning message appears.
- 2 Select { **OK to Erase Title** } and press **OK** on the remote control to proceed.
→ Otherwise, select { **Cancel** } and press **OK** to abort.

Note:

For { **Copy to Recordable DVD** }, see page 38.

Using the HDD edit scene menu

This recorder allows you to edit the video content after a recording has been made. You can insert/delete chapter markers or hide unwanted scenes.

When you play back a recording in video edit mode, the entire recording will be played back including the hidden scenes.

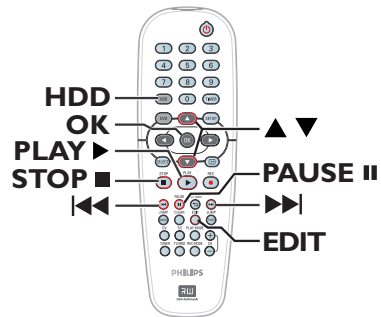

- 1 Press **HDD** on the remote control.
→ The HDD content menu appears.



- 2 Use ▲▼ keys to select a title and press **PLAY** to start playback.

TIPS: No editing can be carried out on a protected title.
Press ◀ to go back to the previous menu item. Press **HDD** to exit the menu.



Edit Recordings - HDD (continued)

- 3 During playback, press **EDIT** on the remote control.
→ The HDD edit scene menu appears.

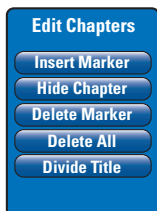

- 4 Use **◀◀ / ▶▶** keys on the remote control to search for the scene you want to edit, then press **PAUSE II**.
- 5 Use **▲▼** keys to access different options in the edit scene menu and press **OK** to select.

{ Insert Marker }

Select this to insert a new chapter marker at the current point of playback. This will allow you to access a specific point in the recording easily or set a chapter you wish to hide (for example, commercial scenes).

{ Hide/Unhide Chapter }

Select this to hide the current chapter or make it visible again. The hidden chapters are displayed in grey while in editing mode. During normal playback, the hidden chapter will be skipped.

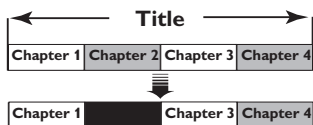

(for example, chapter 2 is selected)

{ Delete Marker }

Select this to delete the current chapter marker (it refers to the closest marker before the current point of playback). The current chapter will then combine with the chapter before it.

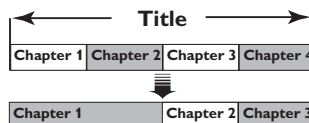

(for example, chapter 2 is selected)

{ Delete All }

Select this to delete all the chapter markers in the current title.

{ Divide Title }

Select this to create a new title from the current point of playback. The existing title will be divided into two separate titles. You can use this function to separate and delete undesired portions of a recording, such as commercials.

Warning! Once a title has been divided, it cannot be reversed.

- 6 To exit, press **EDIT**.

Helpful Hint:

– There is a limit on chapter markers that can be stored within a title and on the hard disk drive.

TIPS: No editing can be carried out on a protected title. Press **◀** to go back to the previous menu item. Press **HDD** to exit the menu.



Editing Recordings - Recordable DVD

About recordable DVD editing

This recorder offers various disc edit options. You can change the disc content and settings of a recorded DVD from the editing menu. If a DVD±R has been finalised, it cannot be edited. The edited contents may not be available if you play the disc on another DVD player.

The displayed options in the editing menu differ depending on the situation and disc type.

Disc settings menu (see pages 52~53)

- Change disc name
- Protect the disc from being erased
- Erase disc
- Make the edited DVD±RW disc compatible
- Finalise DVD±R disc for playback on other DVD players

Title settings menu (see page 54)

- Change title name
- Play back the complete title including the hidden scenes
- Erase title

Edit Chapters menu (see page 55)

- Insert chapter marker
- Hide chapters
- Delete chapter marker
- Delete all chapter markers

Index Picture screen

The Index Picture screen shows your recordings on a DVD±R/±RW. It will appear on the TV once you load the DVD±R/±RW or when playback is stopped.

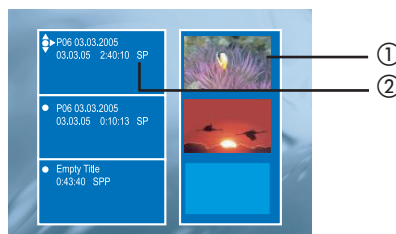

An Index Picture screen represents each item of recording information saved:

- ① The title's index picture.
- ② The title's name (or channel number and date), recording mode and length of the recording.

Making the DVD±R/±RW compatible with this recorder

If a DVD±R/±RW has been recorded in a computer or in another recorder, the Picture Index screen may not be displayed correctly. You can change the format of the disc to 'Philips' type.

- ① With the disc in the recorder, press **STOP** ■.
→ No disc menu is displayed.
- ② Press **SETUP**, select { **Feature** } in the menu and press ►.
- ③ Press ▼ to highlight { **Adapt Disc Menu** } and press **OK**.
→ A confirmation message appears.
- ④ Press **OK** to proceed.

TIPS: No further recording and editing can be carried out on a finalised DVD±R. Press ◀ to go back to the previous menu item.

Editing Recordings - Recordable DVD (continued)

Using the disc settings menu

In the disc settings menu, you can change the disc name, set disc protection, erase disc content, make edit compatible for DVD±RW or finalise disc for DVD±R.

- 1 Insert a recorded DVD into the recorder.
- 2 While the Index Picture screen is displayed, press **▲** on the remote control repeatedly until the main disc content menu appears.

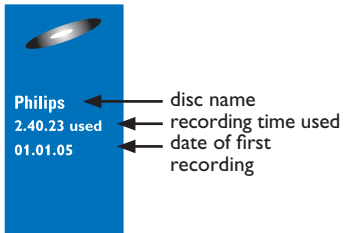

- 3 Press **▶** to display the Disc Settings menu.
→ The setting options are different for DVD±R and DVD±RW.

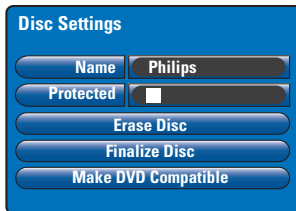

- 4 Use **▲▼** keys to access different options in the menu and press **OK** to select.
→ Instructions and explanations of the options are provided in the following pages.
- 5 To exit Disc Settings menu, press **◀**.

Changing the disc name

The original disc name is generated automatically by this recorder. You can change the disc name by following the steps below.

- 1 In Disc Settings menu, select { **Name** } and press **OK**.
- 2 Use **▲▼** keys to change the character/number.
→ Use **◀▶** keys to move to the previous or next field.
- To switch between upper and lower case characters, press **SELECT** on the remote control.
- To delete the character/number, press **CLEAR** on the remote control.
- 3 Press **OK** to confirm the changes and press **◀** to exit.

Protecting the disc

You can protect the recorded DVD in order to prevent the recording from being accidentally erased or edited.

- In Disc Settings menu, select { **Protected** } and press **OK** to activate () the protect feature.

To remove the protect feature

- Select { **Unprotect Title** } in the menu and press **OK** to deactivate () the feature.

TIPS: No further recording and editing can be carried out on a finalised DVD±R.
Press **◀** to go back to the previous menu item.

Editing Recordings - Recordable DVD (continued)

Erasing disc (DVD±RW only)

This erases the content of the DVD±RW including any content that was not recorded on this recorder. Once the existing content is erased, the disc can be used for recording.

- 1 In Disc Settings menu, select { **Erase Disc** } and press **OK**.
→ A warning message appears.
- 2 Press **OK** to proceed or press ◀ to abort.

Making the edited DVD±RW compatible

The edited DVD±RW may still display the original titles or hidden scenes when played back on other DVD players. This function allows you to make an edited version DVD±RW compatible with other players.

- 1 In Disc Settings menu, select { **Make DVD Compatible** } and press **OK**.
→ A message showing the estimated process time appears.
- 2 Press **OK** to proceed or press ◀ to abort.
→ If the option is not available for selection, it means that the disc is already compatible.

Finalising the DVD±R for playback

It is necessary to finalise a DVD±R disc before you can play it on another DVD player. Otherwise, the DVD±R will only play back on this recorder.

After a DVD±R disc has been finalised, no further recordings or editing can be made to it. Make sure that you have completed all the recordings and editing before finalising the disc.

- 1 In Disc Settings menu, select { **Finalise Disc** } and press **OK**.
→ A message showing the estimated process time appears.
- 2 Press **OK** to proceed or press ◀ to abort.
→ Finalisation may take more than 30 minutes, depending on the length of recordings. Do not try to open the disc tray or turn the power off as this may render the disc unusable.

TIPS: No further recording and editing can be carried out on a finalised DVD±R. Press ◀ to go back to the previous menu item.

Editing Recordings - Recordable DVD (continued)

Using the title settings menu

In the title settings menu, you can change the title name, view the hidden scene or erase the title.

- 1 Insert a recorded DVD into the recorder.



- 2 Use ▲▼ keys to select a title in the Index Picture screen and press ► to display the Title Settings menu.

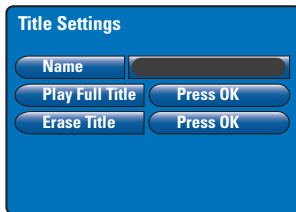

- 3 Use ▲▼ keys to access different options in the menu and press **OK** to select.
→ Instructions and explanations of the options are provided in the following pages.
- 4 To exit Title Settings menu, press ◀.

Changing the title name

The original recording title name is generated automatically by this recorder. You can give a new name to the title by following the steps below.

- 1 In Title Settings menu, select { **Name** } and press **OK**.
- 2 Use ▲▼ keys to change the character/number.
→ Use ◀▶ keys to move to the previous or next field.
- To switch between upper and lower case characters, press **SELECT** on the remote control.
- To delete the character/number, press **CLEAR** on the remote control.
- 3 Press **OK** to confirm the changes and press ◀ to exit.

Playing the entire title including the hidden scenes

- In Title Settings menu, select { **Play Full Title** } and press **OK**.
→ Playback begins automatically.

Erasing title

You can erase a specific title (recording) from the disc. However, for DVD±R, the deleted space cannot be used for further recording.

- 1 In Title Settings menu, select { **Erase Title** } and press **OK**.
→ A warning message appears.
- 2 Press **OK** to proceed or press ◀ to abort.
→ For DVD±RW disc, 'Deleted Title' will appear in the Index Picture screen where the title was erased. The empty space can be used for new recordings.

TIPS: No further recording and editing can be carried out on a finalised DVD±R. Press ◀ to go back to the previous menu item.

Editing Recordings - Recordable DVD (continued)

Using the edit chapters menu

This recorder allows you to edit the video content after a recording has been made. You can insert/delete chapter markers or hide unwanted scenes.

The hidden chapters will play back while in editing mode. You can access editing mode by pressing **EDIT** on the remote control during playback.



- 1 Insert a recorded DVD into the recorder.
→ The Index Picture screen appears.
- 2 Use ▲▼ keys to select a title and press **PLAY ▶** to start playback.
- 3 Hold down ◀◀/▶▶ keys on the remote control to search for the scene you want to edit, then press **PAUSE II**.
- 4 Press **EDIT** on the remote control.
→ The Edit Chapters menu appears.

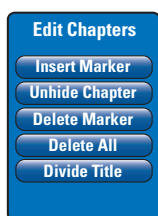

- 5 Use ▲▼ keys to access different options in the edit chapters menu and press **OK** to select.

{ Insert Marker }

Select this to insert a new chapter marker at the current point of playback. This will allow you to access a specific point in the recording easily or set a chapter you wish to hide (for example, commercial scenes).

{ Hide/Unhide Chapter }

Select this to hide the current chapter or make it visible again.

The hidden chapters are displayed in grey while in editing mode. During playback, the hidden chapter will be skipped.

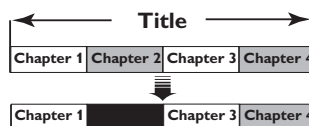

(for example, chapter 2 is selected)

{ Delete Marker }

Select this to delete the current chapter marker (it refers to the closest marker before the current point of playback). The current chapter will then combine with the chapter before it.

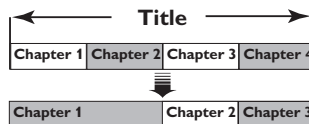

(for example, chapter 2 is selected)

{ Delete All }

Select this to delete all the chapter markers in the current title.

{ Divide Title }

Select this to create a new title from the current point of playback. The existing title will be divided into two separate titles. You can use this function to separate and delete undesired portions of a recording, such as commercials.

Warning! Once a title has been divided, it cannot be reversed.

- 6 To exit, press **EDIT**.

TIPS: No further recording and editing can be carried out on a finalised DVD±R.
Press **RETURN** to go back to the previous menu item. Press **EDIT** to exit the menu.

Setup Menu Options

Accessing the Setup Menu

The setup menu provides various options for you to adjust the recorder to suit your preferences.

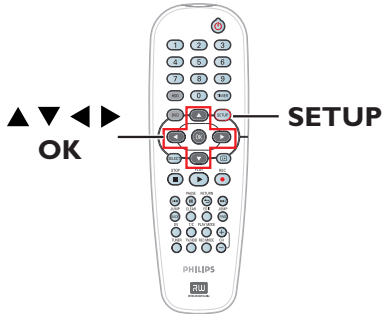

- 1 Press **SETUP** on the remote control.
→ The setup menu appears on TV.



Note: The { **Setup** } option is not accessible when DVD menu is displayed on the screen or during playback.

- 2 Use **▲▼** keys to select a setup option and press **▶** to access.
- 3 Highlight the setting you wish to change and press **OK**. Once you have changed the setting, press **OK** to confirm and go back to the previous selected item.
→ Instructions and explanations of the options are provided in the following pages.
→ If the option in the menu is greyed out, that means the setting is not available or cannot be changed in the current state.
- 4 To exit, press **SETUP**.

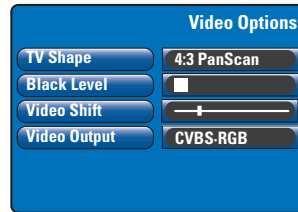

see page 57

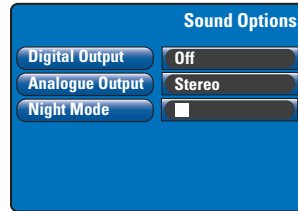

see page 58

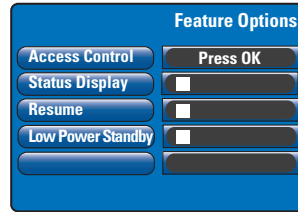

see page 59



see page 57



see page 29

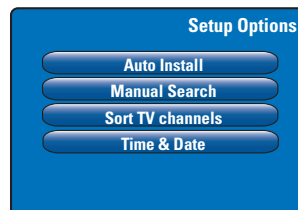

see pages 60~61

Setup Menu Options (continued)

Video settings (underlined options are the factory default settings)

TV Shape

The picture shape can be adjusted to fit your TV.

{ 4:3 Letterbox } – For a 'wide-screen' display with black bars on the top and bottom.



{ 4:3 PanScan } – For a full-height picture with the sides trimmed.



{ 16:9 } – For wide-screen TV (frame ratio 16:9).



Black Level

Adapt the colour dynamic for NTSC disc.

- Improves the colour contrast and brightens the picture of NTSC-compatible DVD.
 – Normal colour contrast.

Video Shift

Use ◀▶ keys to adjust the horizontal position of the picture on your TV screen. Press **OK** to confirm the setting.

Video Output

Chooses the type of video output that matches the video connection between this recorder and your TV, see page 17.

- { YC } – For S-Video connection.
{ CVBS•RGB } – For RGB or CVBS connection.

Language settings (These settings will be taken from the first installation)

Audio

Select the preferred audio language for DVD playback.

Subtitle

Select the preferred subtitle language for DVD playback.

Menu

Select the menu language for this recorder's on-screen display.

Country

Select your country of residence.

Helpful Hints:

- If the selected audio/subtitle language is not available on the disc, the disc's default language will be used instead.
- For some DVDs, the subtitle/audio language can only be changed via the DVD disc menu.

Setup Menu Options (continued)

Sound settings (underlined options are the factory default settings)

Digital Output

This setting is only required if you are using this recorder's COAXIAL OUT socket to connect other audio/video device.

- { **Off** } – Selects this to deactivate the digital audio output. For example, if you use the AUDIO OUT sockets to connect this recorder to a TV or Stereo system.
- { **All** } – Selects this if the connected device has a built-in Multi-Channel decoder that supports one of the multi-channel audio format (Dolby Digital, MPEG-2).
- { **PCM only** } – Selects this if the connected device is not capable of decoding multi-channel audio. The system will convert the Dolby Digital and MPEG-2 multi-channel signals to PCM (Pulse Code Modulation).

Analogue Output

This setting is only required if you are using this recorder's AUDIO OUT L/R sockets to connect other audio/video device.

- { **Stereo** } – Selects this to hear the sound from the left and right audio channels. Use this setting when this recorder is connected to a TV or Stereo system.
- { **Surround** } – Selects this if the connected audio/video device is compatible with Dolby Surround. Dolby Digital and MPEG-2 multi-channel are mixed to a Dolby Surround-compatible two-channel output signal.

Night Mode

This mode optimises playback of sound at low volume. High volume outputs will be softened and low volume outputs are brought upward to an audible level. This feature is only available for DVD video discs with Dolby Digital mode. Press **OK** to select:

- Turns on night mode.
- Disables night mode feature. Select this to enjoy the surround sound with its full dynamic range.

Setup Menu Options (continued)

Feature settings (underlined options are the factory default settings)

Access Control



This is to prohibit viewing of discs that had exceeded the limits you set. Before you can set the parental level or country, you must set a four-digit pin code. Press **OK** to access.

- { **Enter Code** } – When doing this for the first time, use the **numeric keypad 0-9** on the remote control to enter any four-digit you prefer. You must enter the same pin code a second time to confirm it.
 - If you forget your four-digit pin code, press **STOP** ■ four times to revert to default pin code '0000' and enter any four-digit you prefer.
- { **Level** } – It works only on the DVDs with parental level assigned to the complete disc or to certain scenes on the disc. Use ◀ ▶ keys to select a rating level from 1 to 8. The ratings are country-dependent ('1' is considered material that is least offensive and '8' is most offensive). DVDs that are rated higher than the level you selected will not play unless you enter your four-digit pin code.
 - To disable parental controls and allow all discs to play, select '**off**'.
- { **Set Country** } – The Parental control levels depend on the country in which the DVD was manufactured. Therefore, it is necessary to select a geographic area as the playback limitation level.

Status Display

Display the information about the current state of the recorder. Press **OK** to select:

- The current operating information will be displayed for few seconds.
- Turn off the status display.

Resume

With this feature, you can resume playback of the disc from where it last stopped. This applies to the last 20 DVDs and Video CDs you played. Press **OK** to select:

- Turn on auto resume mode.
- The disc will always start from the beginning when you load a disc or start playback.

Low Power Standby

This is an energy saving mode. Press **OK** to select:

- When you switch the recorder to standby mode, the display panel will turn blank to save power.
 - Note:** When this mode is active, automatic SAT(satellite) recording is not possible.
- Clock will display on the recorder's display panel when switching off to standby mode.

Adapt Disc Menu

This option is only visible when you load a DVD±R/±RW that was recorded in another recorder. Make sure that the recorder is in stop mode with no disc menu displayed on the screen, see page 51.

PBC Enable

This option is only visible when a VCD/SVCD is in the disc tray.

Setup Menu Options (continued)

Setup settings (These settings will be taken from the first installation)

Auto Install

Press **OK** on the remote control to start the automatic TV channel search process and replace all previously stored analogue TV channels. This process may take several minutes.

Manual Search

In some cases, not all of the available TV channels may have been found and stored during first installation. In this case, you will need to search for and store the missing or coded TV channels manually. Press **OK** to access the submenus.

Use **▲▼** keys to select the options in the menu and press **OK** to confirm. Press **◀** to go back to the previous menu and press **SETUP** to save and exit.



{ Channel/Freq. }

- Select manual search based on channel allocation or frequency (Programme, FREQ, S. Channel).

Note: S. Channel (Special channel) refers to specified hyperband channels.

{ Entry/Search }

- Use the **numeric keypad 0-9** to enter the channel number of the TV programme or start manual frequency search and press **OK** to confirm.

{ Program # }

- Use the **numeric keypad 0-9** to enter the programme number for the channel to store (e.g., '01') and press **OK** to confirm.

{ Channel Name }

- Use the **▲▼** keys to select the channel name and press **OK** to confirm.

Note: Move to { **Channel Name** } and press **▶▶** to go to the next page or move to { **Decoder** } and press **◀◀** back to the previous page.

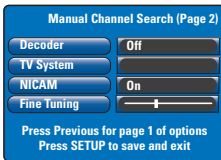

{ Decoder }

- If the current TV channel is transmitted by coded TV signals that can only be viewed properly with a decoder which is connected to the EXT2 AUX-I/O socket, you need to activate the connected decoder.

{ **On** } – Select this to allocate the connected decoder to this TV channel.

{ **Off** } – Turn off the decoder feature.

{ TV System }

- Set the TV system that produces the least distortion of picture and sound. See last page "TV System Guide" for more information.

{ NICAM }

- NICAM is a digital sound transmission system. It can transmit either one stereo channel or two separate mono channels.

{ **On** } – Select this to improve the sound transmission of the TV channel.

{ **Off** } – Select this if the reception is poor and the sound is distorted.

{ Fine Tuning }

- Select this to fine-tune the TV channel manually if the reception is poor. Use **◀▶** keys to adjust the frequency and press **OK** to confirm.

Setup Menu Options (continued)

Setup settings (These settings will be taken from the first installation)

Use **▲▼** keys to select the options in the menu and press **OK** to confirm. Press **◀** to go back to the previous menu and press **SETUP** to save and exit.

Sort TV Channels

You may not agree with the sequence in which the individual TV channels have been allocated to the programme numbers. You can use this function to rearrange or delete unwanted TV channels.

Sort TV channel

- 1) Press **OK** on the remote control to view a list of TV channel.
- 2) Use **▲▼** keys to select the TV channel that you want to move and press **OK** to confirm.
- 3) Use **▲▼** keys to select the position where you want to place the TV channel and press **OK** to swap the TV channel at the selected location.

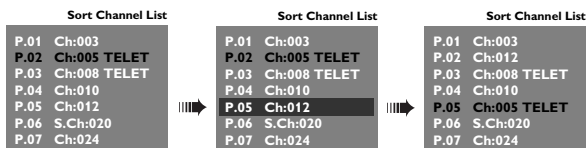

Delete TV channel

- 1) Press **OK** on the remote control to view a list of TV channels.
- 2) Use **▲▼** keys to select the TV channel that you want to delete and press **CLEAR** on the remote control.

Time & Date



The time/date can be set automatically on this recorder if the stored TV programme channel transmits a time signal. Normally programme number '001' is used. If the time/date is incorrect, you must manually set the time/date here.

Use **▲▼** keys to select the digits or use the **numeric keypad 0-9** to make the digit entry.

Use **◀▶** keys to move to the previous/next digit field.

Once complete, press **SETUP** on the remote control to save and exit.

Firmware Upgrade

Installing the latest firmware

Periodically Philips will issue upgrades for the firmware that was initially installed in your recorder as the firmware is continuously refined for greater stability and compatibility of the recorder.

Caution! Power supply must not be interrupted during upgrade!

- ① Get the version information of this recorder by pressing **SETUP** on the remote control.
- ② Press ▼ to select { **Features** } in the menu, then press ►.



- ③ Key in '**1596**' to view the current firmware information.
- ④ Visit the Philips website 'www.philips.com/support' to check the availability of the latest firmware upgrade. Download the firmware to a CD-ROM.
- ⑤ Press **OPEN CLOSE ▲** on the front of the recorder to open the disc tray.
- ⑥ Insert the CD-ROM and press **OPEN CLOSE ▲** again.
 - The firmware will start to install on the recorder automatically.
 - During the upgrade process, it is normal that the recorder will turn on and off occasionally.

Troubleshooting

WARNING

Under no circumstances should you try to repair the system yourself, as this will invalidate the warranty. Do not open the system as there is a risk of electric shock.

If a fault occurs, first check the points listed below before taking the system for repair. If you are unable to remedy a problem by following these hints, consult your dealer or Philips for help.

Problem	Solution
No power.	<ul style="list-style-type: none">– Press the STANDBY-ON button on the front of the recorder to turn on the system.– Make sure the AC outlet has power.
The message “IS TVON?” appears on the display panel.	<ul style="list-style-type: none">– The recorder will not operate until you complete the basic installation. Read chapter “Step3: Installation and Set-up” for details.
The recorder does not respond.	<ul style="list-style-type: none">– There is a technical problem. Disconnect the recorder from the power outlet for 30 seconds, then connect again. If the recorder still will not operate, then reset it to the default factory settings:<ol style="list-style-type: none">1) Disconnect the recorder from the power outlet.2) Press and hold down STANDBY-ON button on the front of the recorder while reconnecting to the power outlet.3) Release STANDBY-ON button when “IS TVON?” appears on the display. All the information stored in the memory (programmes, time) will be cleared. You may need to reset the recorder settings after completing the basic installation.
Remote control does not work.	<ul style="list-style-type: none">– Aim the remote control directly at the sensor on the front of the recorder (not towards TV). If the recorder receives a signal from the remote control, the icon  will appear on the display.– Remove any obstacles between the recorder and remote control.– Batteries are weak. Replace the batteries.
No picture.	<ul style="list-style-type: none">– Turn on your TV and set to the correct Video In channel for the recorder. You may go to Channel 1 on your TV, then press the channel down button on your TV's remote control until you see the TV programme.– Check the video connection between the recorder and the TV.
No sound.	<ul style="list-style-type: none">– Check the recorder audio connection. Read chapter “Basic Recorder Connections - Connecting the audio cables” for details.– Set the Analogue output or Digital output correctly, based on the device you have connected to the recorder. Read chapter “Setup Menu Options - Sound settings” for details.
SAT (satellite) recording does not occur.	<ul style="list-style-type: none">– Check the { Low Power Standby } option is set to ‘Off’ in the { Feature } setting.– Check the { SAT record } option is set to ‘On’ in the { Recording } setting.– Make sure that the Satellite Receiver is connected to the EXT 2 AUX-I/O scart socket.

Troubleshooting (continued)

Problem	Solution
No TV signal received from the recorder.	<ul style="list-style-type: none">– Have your antenna or cable TV signal checked.– Install the TV channel. Read chapter “Setup Menu Options - Setup settings - Auto Install” for details.
Disc will not play.	<ul style="list-style-type: none">– Insert the disc with the label facing up.– Wrong region code. The DVD must be coded for ALL regions or Region 2 in order to play on this recorder.– There is no recording on the disc or wrong disc type. Read chapter “Playback from Disc - Playable discs” for details.– Make sure the disc is not scratched or warped. Clean the disc or use a new one.– Check if the disc is defective by trying another disc.
The picture is distorted or black and white during playback.	<ul style="list-style-type: none">– The disc does not match with the TV colour system standard (PAL/NTSC).– The disc is dirty. Clean the disc.– Sometimes a small amount of picture distortion may appear. This is not a malfunction.
There is picture or sound interference with the TV reception.	<ul style="list-style-type: none">– Have your antenna or cable TV signal checked.– Fine-tune your TV channel. Read chapter “Setup Menu Options - Setup Settings - Manual Search” for details.
Distorted sound coming from a connected hi-fi system or amplifier.	<ul style="list-style-type: none">– Do not connect any cables from the recorder to the ‘Phono’ input of your amplifier.– If you are playing a DTS CD, you must use the COAXIAL or OPTICAL-DIGITAL AUDIO OUTPUT socket of this recorder to connect to the Hi-Fi system or amplifier.
Recordings are not occurring as scheduled. New recordings cannot be made.	<ul style="list-style-type: none">– The TV channel you want to record is not stored or you selected the wrong programme number. Check the TV channels stored.– You must reset the timer recording after adjusting the clock setting.– You cannot use the recorder to duplicate copyright material (DVDs or videotapes) onto a recordable DVD.– The hard disk might be full. Delete some titles to create space for new recordings.
The wrong TV channel was decoded (recorded) after you programmed a recording using the SHOWVIEW® system.	<ol style="list-style-type: none">1) Enter the SHOWVIEW® programming number of the desired TV channel.2) Press OK to confirm.3) Check the channel number in the {Program #} input field. If this does not correspond to the desired TV channel, select this entry field and change the channel number.4) Press OK to confirm.

Troubleshooting (continued)

Problem	Solution
The recorded DVD cannot be played back on another DVD player.	<ul style="list-style-type: none">- If a recording is too short, it is possible that a DVD player cannot detect it. Observe the following 'minimum recording times'. Recording mode : {HQ} – 5 minutes, {SP} – 10 minutes, {SPP} – 13 minutes, {LP} – 15 minutes, {EP} – 20 minutes, {SLP} – 30 minutes, {SEP} – 30 minutes.
The message 'Disc contains unknown data' appears.	<ul style="list-style-type: none">- This message may appear if you insert a disc that was not finalised. DVD±Rs that have not been finalised are very sensitive to fingerprints, dust, or dirt. This may cause problems during recording. To use the disc again, do the following :<ol style="list-style-type: none">1) Make sure that the surface of the disc is clean.2) Press OPEN/CLOSE on the recorder to open the disc tray.3) Insert the disc but do not close the tray.4) Hold down button number {5} on the remote control until the tray closes. This recorder will start the repair process.5) If the disc is recovered, the Picture Index screen will appear. <p>Observe the following:</p> <ul style="list-style-type: none">- Error during recording: The title may be missing.- Error while changing the title/index picture: The original title/index picture may be visible.- Error while finalising: The disc appears not to have been finalised.
Picture is fuzzy and brightness varies when copying DVD Video discs or prerecorded video cassettes.	<ul style="list-style-type: none">- This happens if you try to copy DVDs or video cassettes that have been copy-protected. Even though the picture on the TV is fine, the recording on the recordable DVD is faulty. This interference is unavoidable with copy-protected DVDs or video cassettes.- The recordable DVD has a limited recording lifetime, use a new disc for recording.
'No Signal' appears on the recorder's display panel.	<ul style="list-style-type: none">- No signal received. Check that the cable is plugged in firmly.- If a recording is made from a video recorder, change the tracking on the video recorder.- This recorder may not be able to recognise the video input signal if this signal is poor or does not comply with relevant standards.
The message 'Timer overlaps existing timer' appears.	<ul style="list-style-type: none">- The timer recording overlaps with another timer recording.- If you ignore this warning, the programmed recording with the earlier start time will start first- Change the information for one of the two recordings.- Delete one of the two recordings.
The message 'This will clear the time shift bar' appears.	<ul style="list-style-type: none">- The requested action requires the time shift buffer (temporary HDD storage) to be cleared. All contents not marked for recording will be deleted.

Troubleshooting (continued)

Problem	Solution
<p>Not able to access the { Setup } option to change the tuner settings.</p>	<ol style="list-style-type: none">1) Press DVD and followed by STOP ■.2) Press SETUP to see a list of Setup Menu options. Press ▼ to select { Setup } in the menu and press OK.
<p>Some recordings listed on the HDD menu cannot be played or copied to disc.</p>	<ul style="list-style-type: none">- Some TV broadcasts or videos from external devices which are recorded to this recorder may contain copy protection signals. These cannot be played back from the HDD or copied to a recordable DVD. The copy protected recordings are marked with the icon © in the HDD menu. They are either fully protected (copy never) or partially protected (copy once). For partially protected recording, playback is possible but once copied to a recordable DVD, the recording will be removed from the HDD.
<p>Not able to erase the contents in a DVD±RW which was recorded on another recorder for use on this recorder.</p>	<ul style="list-style-type: none">- Open the disc tray, place the DVD±RW on the disc tray and hold down the CLEAR button until the disc tray closes. You can start recording on the DVD±RW now. Note: If you open the disc tray or turn the recorder off and on before any recording being made, you must repeat the above steps before using the DVD±RW for recording on this recorder.

Video Recording

- Recording system : PAL
- Compression formats: MPEG2
- Recording Modes: HQ (M1), SP (M2), SPP (M2x), LP (M3), EP (M4), SLP (M6), SEP (M8)
- Audio compression: Dolby Digital

Video Playback

- Disc Playback Media: CD-R/CD-RW, DVD±RW, DVD±R, DVD-RW (Video mode), DVD-R, DVD-Video, MP3-CD, Video CD/ SVCD
- Compression formats: MPEG2, MPEG1
- Video disc playback system: NTSC, PAL

Audio Playback

- Disc Playback Media: MP3-CD, CD, CD-R, CD-RW
- Compression formats: Dolby Digital, MP3, MPEG2 Multichannel, PCM
- MP3 bit rates: 80 - 320 kbps

Picture Display

- D/A Converter: 10 bit, 54 MHz
- A/D Converter: 10 bit, 54 MHz

Sound

- D/A Converter: 24 bit, 96 kHz
- A/D Converter: 24 bit, 96 kHz

Still Picture Playback

- Disc Playback Media: Picture CD
- Picture compression formats: JPEG
- Picture enhancement: Rotate, Slideshow, Zoom

Storage Media

- Hard disk Capacity:
 - DVDR3300H: 80 GB
 - DVDR3330H: 160GB
 - DVDR5330H: 250GB
- Recording media: DVD±R, DVD±RW
- HDD recording enhancements: Instant Replay, Time Shift Buffer

Tuner/Reception/Transmission

- TV system: PAL, SECAM
- Aerial Input: 75 ohm coaxial (IEC75)

Connectivity

- Rear Connections
 - Scart 1 (cvbs, S-video/RGB out)
 - Scart 2 (cvbs, S-video/RGB in)
 - S-video out
 - Video out (cvbs)
 - Analogue Audio left/right out
 - Digital audio out (coaxial/optical)
 - RF antenna in
 - RF TV out
 - Mains
- Front Connections
 - i.LINK DV in (IEEE 1394 4-pin)
 - S-video in
 - Video in (cvbs)
 - Audio left/right in

Convenience

- Programming/timer Enhancements: Automatic Satellite, Recording, Daily/Weekly/Monday-Friday, Repeat Program, Manual Timer, SHOWVIEW®, VPS/PDC recording control
- Child Protection: Parental Control
- Clock: Smart Clock
- Digital Content Management: Digital Photo Manager
- Ease of Installation: Auto install
- Programmable events: 8

Power

- Power supply: 200 – 240 V, 50Hz
- Standby power consumption: 3.0W
- Power Consumption: 28 W

Dimensions

- Set dimension (W x H x D): 435 x 65 x 340 mm
- Set weight: 4 kg

Specification and design and subject to change without notice.

Glossary

Analogue: Sound that has not been turned into numbers. Analogue sound varies, while digital sound has specific numerical values. These sockets send audio through two channels, the left and right.

Aspect ratio: The ratio of vertical and horizontal sizes of a displayed image. The horizontal vs. vertical ratio of conventional TVs is 4:3, and that of wide-screens is 16:9.

AUDIO OUT sockets: Red and white sockets on the back of the system that send audio to another system (TV, Stereo, etc).

Chapter: Sections of a picture or a music piece on a DVD that are smaller than titles. A title is composed of several chapters. Each chapter is assigned a chapter number enabling you to locate the chapter you want.

Digital: Sound that has been converted into numerical values. Digital sound is available when you use the DIGITAL AUDIO OUT COAXIAL. These sockets send audio through multiple channels, instead of just two channels as analogue does.

Disc menu: A screen display prepared for allowing selection of images, sounds, subtitles, multi-angles, etc recorded on a DVD.

Index Picture Screen: A screen that gives an overview of a DVD±RW or DVD±R. An Index Picture represents each recording.

HDD (Hard disk drive): This is a mass data storage device used in computers, etc. Disks are flat, circular, rigid plates coated with a thin magnetic media. Magnetic heads record data on the rapidly spinning disks. This facilitates the reading and writing of large amounts of data at high speed.

JPEG: A very common digital still picture format. A still-picture data compression system proposed by the Joint Photographic Expert Group, which features small decrease in image quality in spite of its high compression ratio.

MP3: A file format with a sound data compression system. "MP3" is the abbreviation of Motion Picture Experts Group I (or MPEG-I) Audio Layer 3. By using the MP3 format, one CD-R or CD-RW can contain about 10 times more data than a regular CD.

PBC: Playback Control. Refers to the signal recorded on video CDs or SVCDs for controlling playback. By using menu screens recorded on a Video CD or SVCD that supports PBC, you can enjoy interactive playback and searching.

PCM: Pulse Code Modulation. A digital audio encoding system.

Parental control: Limits disc play according to the age of the users or the limitation level in each country. The limitation varies from disc to disc; when it is activated, playback will be prohibited if the software's level is higher than the user-set level.

Region code: A system allowing discs to be played only in the region designated. This unit will only play discs that have compatible region codes. You can find the region code of your unit by looking on the product label. Some discs are compatible with more than one region (or ALL regions).

S-Video: Produces a clear picture by sending separate signals for the luminance and the color. You can use S-Video only if your TV has an S-Video In socket.

Title: The longest section of a movie or music feature on DVD. Each title is assigned a title number, enabling you to locate the title you want.

VIDEO OUT socket: Yellow socket on the back of the system that sends the DVD picture video to a TV.

Display panel symbol/messages

The following symbols/messages may appear on your recorder display:



- **00:00**
Multifunction display/text line
 - Title/track number
 - Total/elapsed/remaining title/track time
 - Disc/title name
 - Error or warning messages
 - Additional information regarding the disc
 - TV channel number or source of video
 - Clock (This is displayed in Standby mode).
 - TV programme title
- **O||**
Remote control command for the recorder has been received.
- **⊕ TIMER**
A timer recording has been programmed or is active.
- **& SAT**
The recorder is prepared for satellite recording.
- **BLOCKED**
The disc tray cannot be opened or closed due to some mechanical obstruction.
- **CLOSING**
Disc tray is closing.
- **DISC FULL**
Disc is full. There is no storage space for new recordings.
- **EMPTY**
No recordings in the hard disk drive or recordable DVD.
- **IS TVON?**
The recorder is currently in the basic installation mode. Turn on your TV and read chapter 'Step3: Installation and Set-up' for details.
- **LIVE P_XX**
The current live TV channel.
- **MENU**
The disc menu or timer menu display is on.
- **NO DISC**
No disc has been inserted. If a disc has been inserted, then it is possible that the disc cannot be read.
- **NO SIGNAL**
No signal or poor signal strength.
- **OPENING**
Disc tray is opening.
- **READING**
Disc is being recognised by the recorder.
- **STARTING**
The recorder has been turned on.
- **WAIT _XX**
Wait until this message disappears. The recorder is busy processing an operation. XX indicates the number of found channels, and is constantly updated.