

Caplio RZ1 RICOH

Camera User Guide

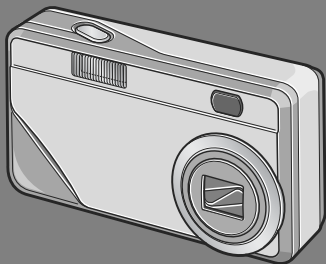

- 1 Quick Guide
- 2 A Variety of Shooting Techniques/Playback
- 3 Changing Camera Settings
- 4 Installing Software
- 5 Troubleshooting



Caution!

Do not connect the USB cable yet!

If you connect the camera to a computer through the USB cable before installing the provided software on the computer, the software required for connection between camera and computer may not be installed appropriately.

Be sure to connect the camera to your computer after installing the provided software.

For how to install the software, see P.106.

About other documentation

Detailed explanations on how to use the provided software can be found in "Software User Guide" (PDF format file) included in the attached CD-ROM.

For how to display the PDF file, see P.107.



Preface

This manual provides information on how to use the shooting and playback functions of this product, as well as warnings on its use. To make the best use of this product's functions, read this manual thoroughly before use. Please keep this manual handy for ease of reference.

Ricoh Co., Ltd.

- | | |
|---------------------------------|---|
| Safety Precautions | For the safe use of your camera, be sure to read Safety Precautions thoroughly before use. |
| Test shooting | Please be sure to do some test shooting to make sure it is recording properly before using it for real. |
| Copyright | Reproduction or alteration of copyrighted documents, magazines, music and other materials, other than for personal, home or similarly limited purposes, without the consent of the copyright holder is prohibited. |
| Exemption from Liability | Ricoh Co., Ltd. assumes no liability for failure to record or play back images caused by malfunction of this product. |
| Warranty | This product is manufactured to local specifications and the warranty is valid within the country of purchase. Should the product fail or malfunction while you are abroad, the manufacturer assumes no responsibility for servicing the product locally or bearing the expenditure incurred therefore. |
| Radio Interference | Operating this product in the vicinity of other electronic equipment may adversely affect the performance of both devices. In particular, operating the camera close to a radio or television may lead to interference. If interference occurs, follow the procedures below. <ul style="list-style-type: none">• Move the camera as far away as possible from the TV, radio or other device.• Reorient the TV or radio antenna.• Plug the devices into separate electrical outlets. |

- This publication may not be reproduced in whole or in part without the express written permission of Ricoh.
© 2004 RICOH CO.,LTD. All rights reserved.
- The contents of this document may be changed in the future, without prior notice.
- This booklet was created with thorough attention to the content. If, however, you have a question, spot an error, or find a description lacking, please refer to the end of this booklet for information on how to contact us.

Microsoft, MS, Windows and DirectX are registered trademarks of Microsoft Corporation in the United States of America and other countries.

Adobe and Adobe Acrobat are trademarks of Adobe Systems Incorporated.

All trademarked company and product names mentioned in this manual are the property of their respective owners.

Key Features

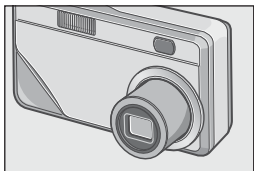

Equipped with a zoom lens in 3x.

This product has a compact body only 25 mm thick, featuring a 35- to 105-mm* 3x lens that applies to most normal shooting. The lens supports the shooting of various indoor and outdoor scenes.

* Equivalent to that on a 35mm camera



1-cm macro (P.31) and close flashing for 16 cm (for Telephoto) or 17 cm (for Wide-angle) (P.32)

The unsurpassed macro function allows you to capture details from a very close distance at only 1 cm. The camera also has a built-in flash for very close shots within 16 cm (for Telephoto) and 17 cm (for Wide-angle). This combination will give you clear macro shots even under low light conditions.



AF target shift function for easy focus lock even on a tripod (P.61)

The camera has an AF target shift function. At macro shooting, the AF target shift function allows you to lock the focus only by button operation without moving the camera itself.

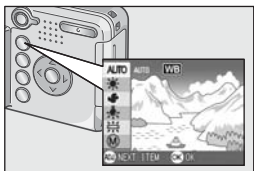

Adjust (ADJ.) button for easy customizing to optimum setting (P.49)

The ADJ. button reduces button operation steps. It allows you to quickly adjust the exposure, white balance, and ISO sensitivity with minimum steps. You can also assign a function as required.



High-quality movie of 15 frames/second (P.75)

A high-quality movie of 320 x 240 pixels can be shot at 15 frames/second.



Scene mode for easy and beautiful shooting (P.33)

In Scene Mode, you need only to select from among six types of shooting modes for shooting with optimal settings for the scene.

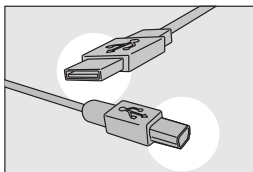

Instant transfer to PC through the USB cable

If the provided software is installed on your computer, just connecting the camera to your computer with the provided USB cable will automatically transfer images to your computer.



Provided with software having an image correction function for finishing images more beautifully

The provided image editing software CaplioViewer has an automatic image correction function for correcting the brightness, hue, and contrast automatically. You can partially crop an image (trimming) or change its size.

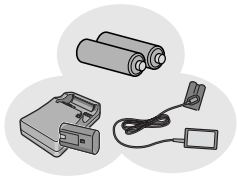

Choice of three power sources makes sure you won't miss any shooting opportunities (P.16)

The camera can be used with one of three power supplies: AA alkaline battery easily available anywhere, a large-capacity rechargeable battery (sold separately) for continuous shooting up to 5,000 pictures, and an economical AC adapter (sold separately) useful for transfer to a computer.

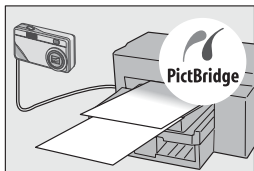

Direct printing without requiring any computer (P.44)

A direct print compatible printer can be connected to the camera with the USB cable for direct transfer. This allows for easy printing without using a computer.

Contents

Chapter 1 Quick Guide

| | |
|--|-----------|
| Before Shooting | 10 |
| Packing List | 10 |
| Names of parts | 12 |
| About LCD Monitor Display | 14 |
| Getting Ready to Shoot | 16 |
| About the Batteries | 16 |
| About an SD Memory Card (available in stores) | 19 |
| Loading the Batteries and SD Memory Card | 20 |
| Turning the Power On/Off | 21 |
| Setting the language | 22 |
| Setting the date and time | 23 |
| Changing the Display | 24 |
| Basic Shooting | 25 |
| How to Hold the Camera | 25 |
| Checking the Focus and Shooting (Half-press)..... | 26 |
| When the Subject is not Centered(Shooting with Focus-lock) | 28 |
| Using the Zoom Function | 30 |
| Shooting Close-Ups (Macro-Mode)..... | 31 |
| Using the Flash | 32 |
| Shooting with Scenery-Matching..... | 33 |
| Playing Back | 34 |
| Checking the image you just took (Quick Review) | 34 |
| Viewing Your Images | 35 |
| Thumbnail Display..... | 36 |
| Magnifying Images | 37 |
| Viewing on a Television | 38 |
| Erasing | 40 |
| Erasing Unwanted Images | 40 |
| Erasing Multiple Frames at One Time | 41 |

Chapter 2 A Variety of Shooting Techniques/Playback

| | |
|---|-----------|
| Direct Printing | 44 |
| Direct Print Function..... | 44 |
| Connecting the Camera to a Printer..... | 44 |
| Printing Still Images..... | 45 |
| A Variety of Shooting Techniques | 49 |
| Using the ADJ. (Adjust) Button..... | 49 |

| | |
|--|-----------|
| Shooting Setting Menu | 50 |
| Using the Shooting Setting Menu | 51 |
| Changing the Exposure (EXPOSURE COMP.) | 52 |
| Using Natural and Artificial Lighting (WHITE BALANCE) | 53 |
| Changing Sensitivities (ISO SETTING) | 55 |
| Changing Shading for Shooting Text (DENSITY) | 56 |
| Choosing Picture Quality Mode/Image Size (PIC QUALITY/SIZE) | 57 |
| Manual Focus Shooting (FOCUS) | 59 |
| Using the AF Target Shift Function | 61 |
| Changing the Edge Quality of Still Images (SHARPNESS) | 62 |
| Changing the Light Metering (PHOTOMETRY) | 63 |
| Using the Self-Timer | 64 |
| Using Long Time Exposure (TIME EXPOSURE) | 65 |
| Shooting Pictures Automatically at Set Intervals (INTERVAL) | 66 |
| Limiting the Shutter Release Speed (SLOW SHUTTER LMT) | 68 |
| Inserting the Date into a Still Image (DATE IMPRINT) | 69 |
| Returning the Shooting Setting Menu Settings to their Defaults (RESTORE DEFAULTS) | 70 |
| Shooting with Multi-Shot | 71 |
| CONT | 73 |
| SCONT (S Multi-Shot) | 73 |
| MCONT (M Multi-Shot) | 73 |
| Viewing an S Multi-Shot or M Multi-Shot Still Image in Enlarged Display Mode | 74 |
| Shooting/Playing Back Movies | 75 |
| Shooting Movies | 75 |
| Playing Back Movies | 76 |
| Other Functions Available in Playback Mode | 77 |
| Playback Setting Menu | 77 |
| Using the Playback Menu | 77 |
| Showing Photos in Order Automatically (SLIDE SHOW) | 78 |
| Write-protecting Your Images (PROTECT) | 79 |
| Using a Printing Service (DPOF: Dee-Pof) | 82 |
| Changing the Image Size (RESIZE) | 85 |
| Copying the Contents of Internal Memory to a Memory Card (COPY TO CARD) | 86 |

Chapter 3 Changing Camera Settings

| | |
|--|-----------|
| Changing Camera Settings | 88 |
| SETUP Menu | 88 |
| Using the SETUP Menu | 89 |
| Getting the SD Memory Card Ready for Use (FORMAT [CARD]) | 90 |
| Formatting Internal Memory (FORMAT [INT. MEM.]) | 91 |
| Adjusting the Brightness of the LCD Monitor (LCD BRIGHTNESS) | 92 |
| Setting a Function to the ADJ. Button (ADJ BTN.SET.) | 93 |
| Changing the Beep Sound Setting (BEEP SOUND) | 94 |
| Changing Image Confirmation Time (LCD CONFIRM.) | 95 |
| Changing Auto Power-Off Settings (AUTO POWER OFF) | 96 |
| Changing File Name Settings (SEQUENTIAL NO.) | 97 |
| Changing Power-Save Mode Settings (POWER-SAVE) | 98 |
| Setting the Date and Time (DATE SETTINGS) | 100 |

| | |
|--|-----|
| Changing the Display Language (LANGUAGE)..... | 101 |
| Changing the Playback Method for Viewing on TV (VIDEO OUT MODE)..... | 102 |
| Displaying a Setting Change Warning (SHTG STGS WARNG.)..... | 103 |

Chapter 4 Installing Software

Installing the Provided Software (For Windows)..... 106

| | |
|---|-----|
| System Requirements for Using the Provided Software | 108 |
| Installing the Software on Your Computer (Windows XP)..... | 109 |
| Installing the Software on Your Computer (Windows 98/98SE/Me/2000)..... | 111 |
| Connecting the Camera to Your Computer | 113 |
| Installing Other Software | 115 |
| Uninstalling the Software..... | 117 |

Installing the Provided Software (For Macintosh)..... 118

| | |
|---|-----|
| System Requirements for Using the Provided Software | 120 |
| Installing the Software on Your Computer (Mac OS 8.6 to 9.2.2) | 121 |
| Installing the Software on Your Computer (Mac OS X 10.1.2 to 10.3)..... | 122 |

Chapter 5 Troubleshooting

Troubleshooting 126

| | |
|---------------------------------|-----|
| Troubleshooting the Camera..... | 126 |
|---------------------------------|-----|

Appendices 131

| | |
|---|-----|
| A. Specifications..... | 131 |
| B. Optional Accessories | 133 |
| C. Combination of Scene Mode and Function..... | 135 |
| D. Menu Items By Mode..... | 136 |
| E. Functions Whose Defaults will be Restored upon Power-off | 137 |
| F. Number of Images That Can be Stored in Internal Memory/SD Memory Card..... | 138 |
| G. Using Your Camera Abroad | 139 |
| H. Cautions on Use | 140 |
| I. Care and Storage | 141 |
| J. Error Messages | 142 |
| K. Warranty and Servicing..... | 143 |
| Index..... | 145 |

Using Manuals

The two manuals included are for your Caplio RZ1.

Camera User Guide (This booklet)

This guide explains the usage and functions of the camera. You will also see how to install the provided software on your computer.

Software User Guide (PDF file)

This guide explains how to download images from the camera to your computer, and display and edit them on your computer.

*The Software User Guide is available from the following folder on the provided CD-ROM.



Each language has its own Software User Guide in the respective folder.





To copy the Software User Guide onto your hard disk

Copy the PDF file from the above folder.

How to Use This Guide

Chapter 1 explains the basic operations of this product.
If you are using the camera for the first time, read from this chapter.

The following symbols are also used in this guide:

| | |
|---|--|
|  Important | This indicates important notices and restrictions for using this camera. |
|  Note | This indicates supplementary explanations and useful tips about camera operations. |
|  Term | This indicates terms that are useful for understanding the explanations. |
|  Reference | This indicates page(s) relevant to a particular function. |

The LCD Monitor Display examples may be different from actual display screens.

Chapter 1

Quick Guide

If you are using the camera for the first time, read from this chapter.

| | |
|-------------------------------------|-----------|
| Before Shooting | 10 |
| Getting Ready to Shoot | 16 |
| Basic Shooting | 25 |
| Playing Back..... | 34 |
| Viewing on a Television..... | 38 |
| Erasing | 40 |

Before Shooting

Open the package and make sure all the items are included.

Packing List

- Caplio RZ1

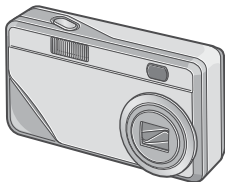

- Handstrap



- AA Alkaline Batteries (LR6) (2)

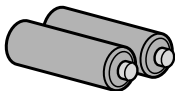

- VIDEO cable

Used when viewing your images on a TV unit.



- USB Cable

Used to connect the camera to a computer or Direct Print supported printer.



Note

Attaching the hand strap to the camera

Thread the tips of the strap through the camera's strap eyelet and loop them as shown.

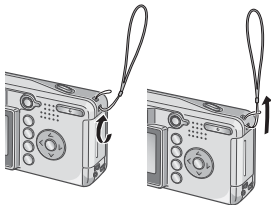

- Camera User Guide
(This booklet)



- Warranty



- Safety Precautions



- Caplio Software CD-ROM
The provided software and the Software User Guide are included on this CD-ROM.



Optional Accessories

- AC Adapter (AC-4b)
Used for power supply from a home outlet to the camera. Connect this adapter for long time play or image transfer to a personal computer.

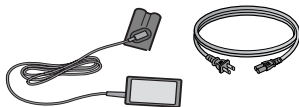

- Rechargeable Battery (DB-50)



- Rechargeable Battery Set (BS-5)
Includes the Rechargeable Battery (DB-50) and Battery Charger.



- PC Card Adapter (FM-SD53)
For when you want to load an SD Memory Card directly into your computer's PC Card Slot.
- Soft Case (SC-50)
- SD Memory Card (available in stores)

Names of parts

Camera

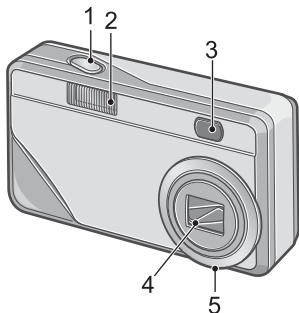

Front View

1. Shutter Release Button (P.25)
 2. Flash (P.32)
 3. Viewfinder
 4. Lens (P.25)
 5. Front Panel Removal Mark
- Be sure to leave it locked during use.

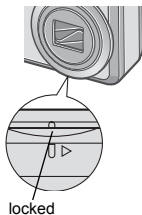

About the Mode Selector

You can select one of three modes with the mode selector.

| | | |
|---|------------------|-----------------------------------|
|  | Movie Mode | Allows you to shoot movies. |
| | Still Image Mode | Allows you to shoot still images. |
| | Playback Mode | Allows you to playback images. |

Rear View

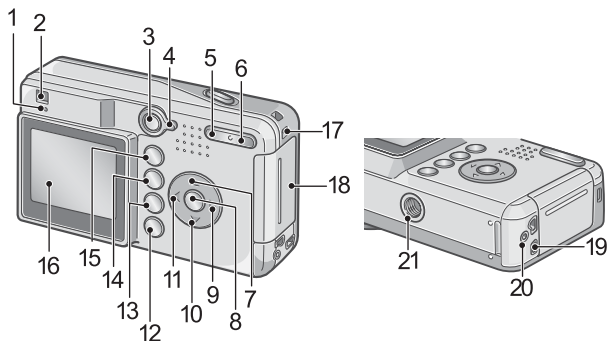

- | | |
|--|--|
| 1. Auto Focus/Flash Lamp (P.26/P.32) | 11. (Flash) Button (P.32) |
| 2. Viewfinder | 12. DISP. Button (P.24) |
| 3. Power Switch (P.21) | 13. (Delete) (P.40)/ (Self-timer) Button (P.64) |
| 4. Mode Selector (P.12) | 14. MENU Button (P.51, P.77, P.88) |
| 5. (Wide-angle) (P.30)/ (Thumbnail Display) Button (P.36) | 15. ADJ. Button (P.49) |
| 6. (Telephoto)(P.30)/ (Enlarged View) Button (P.37) | 16. LCD Monitor |
| 7. /MODE Button (P.33) | 17. Strap Eyelet (P.10) |
| 8. OK Button | 18. Battery/Card Cover |
| 9. (Quick Review) Button (P.34) | 19. Video Output Terminal (P.38) |
| 10. (Macro) Button (P.31) | 20. USB Terminal (P.113) |
| | 21. Tripod Screw Hole (underside) |

About LCD Monitor Display

Screen Examples when Shooting Pictures

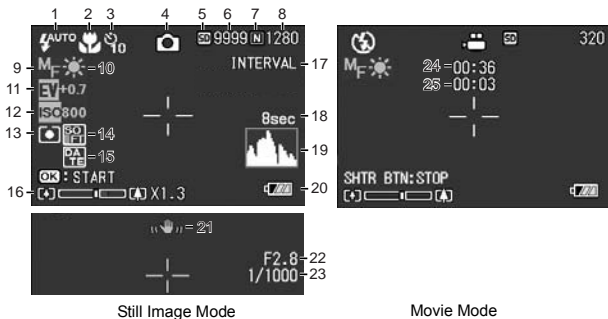

- Flash (P.32)
- Macro Shooting (P.31)
- Self-timer (P.64)
- Mode Types
- Recording Destination (P.19)
- Remaining Number of Still Images (P.138)
- Picture Quality (P.57)
- Image Size (P.57)
- Focus (P.59)
- White Balance (P.53)
- Exposure Comp. (P.52)
- ISO Setting (P.55)
- Photometry (P.63)
- Sharpness (P.62)
- Date/Time (P.69)
- Zoom Bar (P.30)
- Interval (P.66)
- Time Exposure (P.65)
- Histogram (P.24)
- Battery (P.16)
- Camera Shake (P.25)
- Aperture Value (P.26)
- Shutter Speed (P.26)
- Remaining Recording Time (P.138)
- Recording Time (P.138)

Note

The approximate number of remaining shots available is displayed. Further shooting may be possible depending on the subject. Since the remaining number of shots is recalculated at power-on or mode change (Still Image Mode or Playback Mode), the displayed value may change.

The Screen During Playback

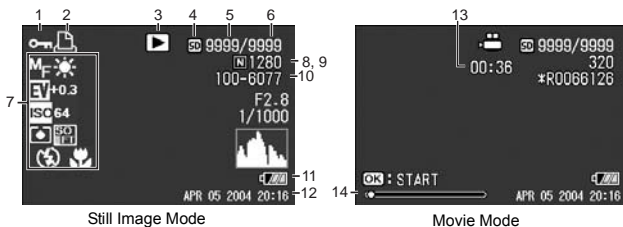

- | | |
|------------------------------------|------------------------------------|
| 1. Protect (P.79) | 8. Picture Quality (P.57) |
| 2. DPOF (P.82) | 9. Image Size (P.57) |
| 3. Mode Types | 10. File No. |
| 4. Playback Data Source (P.35) | 11. Battery (P.16) |
| 5. Number of Playback Files | 12. Date at Shooting (P.69, P.100) |
| 6. Total Number of Files | 13. Recording Time or Lapsed Time |
| 7. Setting at Shooting (Recording) | 14. Indicator |



Note

The LCD monitor may display messages to inform you of operational instructions or the camera's status while in use.

Getting Ready to Shoot

Turn the power on and get ready to shoot.



Note

If you have already used this camera, follow the steps below to make sure it is turned off before removing or loading batteries.

1. Make sure the LCD monitor is turned off.
2. Make sure the lens cover is closed.

For how to turn the camera off, see P.21.

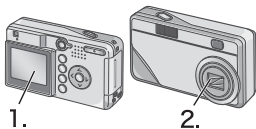

About the Batteries

The following batteries can be used in the camera. Please choose which kind to use according to your needs.

• AA Alkaline Batteries (LR6) (included)

You can obtain them anywhere, so they are convenient for travel. However, in a low-temperature environment the number of shots you can take will decrease. Warm the batteries before use. It is recommended that you use the rechargeable battery when using the camera for a long time.

• Rechargeable Battery (DB-50) (sold separately)

This is a lithium-ion battery. This is economical because you can recharge it using the battery charger (sold separately) and use it over and over again. They last a long time, so they are convenient for travel.

• AA Nickel Batteries (available in stores)

These batteries are not rechargeable. However, they last a long time as compared with AA Alkaline Batteries when used with a digital camera.

• Nickel-Hydrogen Battery (available in stores)

This is economical because you can recharge and use it over and over again. Use a charger (available in stores) for charging.

The battery may be inert and consequently it may not supply power immediately after it is purchased or left unused for more than a month. In such a case, recharge the battery two or three times before use. The battery self-discharges with time even if the camera is not used, so recharge it before use.

In addition to the batteries, you can use the AC Adapter (P.133).



Note

Indication of the number of images you can take

| Battery Type | Number of Shots |
|------------------------------|-----------------|
| Rechargeable Battery (DB-50) | Approx. 500 |
| AA Alkaline Batteries (LR6) | Approx. 300 |

- The number of shots is based on a temperature of 22 degrees Celsius, shooting at 30 second intervals and one out of every two being shot with the flash. If you set the camera to the Power-Save or Synchro-Monitor mode, the number of shots you can take will increase.
- The number of shots is for reference only. If the camera is used for long periods of time for setting and playback, the shooting time (the number of shots) will decrease.



Reference

- For how to insert the Rechargeable Battery, see P.133.
- For how to use the AC Adapter, see P.134.



Caution

- Other batteries, such as manganese dry cell (R6) and Ni-Cd, cannot be used.
- You may not use CR-V3.
- Please remove the batteries if you are not going to use the camera for a long period of time.
- The life of an AA alkaline battery (LR6) depends on the brand and the storage time from the date of production. In addition, the life of an alkaline battery becomes shorter at low temperatures.
- The Nickel-Hydrogen Battery is not factory-charged. Charge it before use. Immediately after the purchase or after a long storage, the battery may not be charged fully. Repeat charging and discharging before use. For details, see the documentation that came with the battery or charger.
- The battery may become very hot immediately after operation. Turn the camera off and leave it to cool down sufficiently before removing the battery.



Note

Battery level indication

A battery mark appears at the lower left of the LCD monitor to indicate the battery level. Prepare new batteries before the batteries wear out.

| Battery Mark | Description |
|--------------|--|
| | Sufficient battery charge |
| | Low remaining charge: Prepare new batteries. |
| | No remaining charge: Replace the batteries. |



Caution

- If you are using nickel metal hydride batteries, may not appear or or may appear immediately depending on the battery type and environmental conditions. Check the batteries at hand before use.
- If you are using the AC Adapter, may appear. This does not indicate malfunction and you can continue to use the camera.

About an SD Memory Card (available in stores)

You can store still images you have taken either in the camera's internal memory or on an SD Memory Card (available in stores). The internal memory capacity is 12 MB. When you want to record a lot of images, or images at high resolutions, use a high-capacity SD Memory Card.



Note

Where images are recorded

When no SD memory card is inserted, the camera records images in the internal memory; when an SD memory card is inserted, it records images on the memory card.

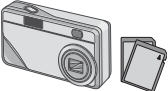
| When no memory card is loaded | When an SD Memory Card is loaded |
|---|---|
|  |  |
| Records to internal memory | Records to the SD memory card |



Caution

- If an SD memory card is loaded, the camera will not record to the internal memory, even if the card is full.
- Take care not to get the metal parts of the card dirty.



Note

Write-protecting your images

If you move the card's write-protection switch to LOCK, your still images cannot be accidentally erased and the memory card cannot be formatted. If you release the protection (by returning the switch to its original position), it is once again possible to erase images and format the card.

So it's a good idea to switch to LOCK when you have some important data recorded.

Note that you cannot shoot images in the LOCK state because no data can be recorded on the card. Unlock the card when shooting.

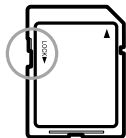

Reference

- For switching between the SD Memory Card and internal memory during playback, see P.35.
- For recording capacities, see P.138.

Loading the Batteries and SD Memory Card

If you have already used this camera, make sure it is turned off before loading batteries and memory card.

1. Open the battery/card cover.

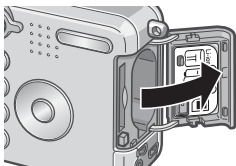
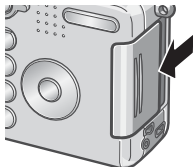

2. Make sure the card is facing the right way and then push the card all the way in until it clicks.

You may load the batteries first.

3. Insert the two batteries, making sure they are facing the correct way.

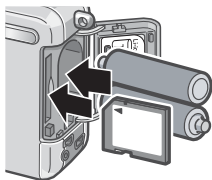

4. Close the battery/card cover and slide it back into place.

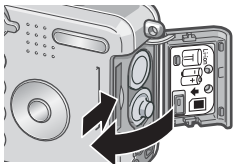

Reference

For how to format an SD memory card, see P.90.

Turning the Power On/Off

To turn the power on:

1. Press the power button.

After the start sound, the auto-focus/flash lamp blink for several seconds. For power-off, press the power button again.

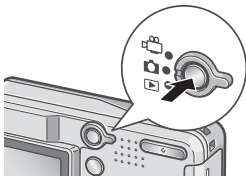

Note

If the LCD monitor does not come on

When the Power-Save mode is set to ON, the LCD monitor does not come on during the Still Image/Movie mode. Display the SETUP menu to turn the Power-Save mode OFF.

Power-Save Mode

The power consumption of the LCD monitor can be reduced and the battery life extended by setting the Power Saving mode to on.

Auto Power Off

If the camera goes unused for a set period of time, it will automatically turn itself off to save power. To use the camera again, simply press the power button.



Reference

- For how to activate Power Save Mode, see P.98.
- For how to change the Auto Power Off setting, see P.96.

Setting the language

When the power is turned on for the first time, the language setting screen appears (for the LCD monitor display language). After setting the language, go on to the date/time setting (for printing the date and time on your photos).

You can shoot without these settings. However, be sure to set the language, and the date/time later. Use the SETUP screen for these settings.



Note

To display the SETUP screen, turn the mode dial to SETUP.

1. Turn the power on for the first time after purchase.

The language selection screen appears.

To skip language setting, press the MENU button.

When the MENU button is pressed, the language setting is cancelled and the video signal format-setting screen appears.

2. Press the ▲▼◀▶ buttons to select a language.

3. Press the OK button.

The display language is set, and the date/time setting screen appears.



Reference

For how to set the display language and date/time on the SETUP screen, see "Changing the Display Language (LANGUAGE)" and "Setting the Date and Time (DATE SETTINGS)" in this guide.

Setting the date and time

When the power is turned on for the first time and the language setting is completed, the date/time setting screen appears.

1. Press the ▲▼◀▶ buttons to set the year, month, date and time.

Change the value with ▲▼ and move the frame with ◀▶.

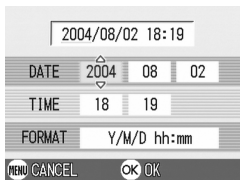

2. In [FORMAT], choose the Date and Time format.

Select the format with ▲▼.

3. Check the display on the bottom of the screen and then press the OK button.

The date is set.

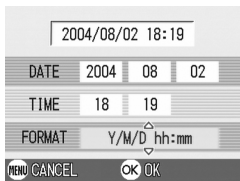

Note

If the batteries are removed for more than one week, the date and time settings will be lost. These settings must be made again. Any other changes you made with the Setup mode and Shooting setup menu will also be reset.



Reference

- For how to correct the date and time, see P.100.
- For how to put a date stamp on each frame, see P.69.

Changing the Display

If you press DISP., you can change the screen display mode, such as switching between display/no display of symbols, etc.

Every time you press the DISP. button, the view cycles in the order of Histogram On, Grid Guide, No Display, LCD Monitor Off, and Normal Symbol Display.

Normal Symbol Display



Histogram On



Grid Guide

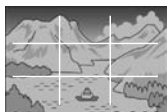

LCD Monitor Off
(Synchro-Monitor Mode)

Switches screens with the
DISP button



No Display



Term

Histogram On

The LCD monitor displays a histogram at the lower right of the screen. A histogram is a kind of graph indicating image brightness. By using a histogram, you can prevent voids and solids.

* The histogram displayed on the LCD monitor is for reference only. Depending on the shooting condition (flashing is required, the surrounding light is dark, and so on), the exposure level indicated in the histogram may not correspond to the brightness of the shot image.

Grid Guide

Displays auxiliary lines on the LCD monitor to help shooting. These lines are not recorded with images.

Synchro-Monitor Mode

Keeps the LCD monitor off except when the camera is operated. This mode is effective for saving power consumption. With this mode, half-pressing the shutter release button turns the LCD monitor on. Subsequently, full-pressing the shutter release button displays the shot image on the LCD monitor, and then turns the LCD monitor off.

Basic Shooting

Now you are ready. Let's shoot!

How to Hold the Camera

If the camera moves when you press the shutter button, the still image might not come out clearly (due to camera shake). The  mark displayed on the LCD monitor indicates that camera shake should be avoided under the current shooting condition. Hold the camera as illustrated below for best results.

1. **Hold the camera with both hands and lightly press both elbows against your body.**



2. **Put your finger on the shutter button.**

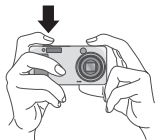

Note

- Be careful when you are shooting not to get a finger, your hair, or the strap in front of the lens or the flash.
- To prevent camera shake, hold the camera securely with both hands when you shoot or use a tripod.
- Consider using a tripod to prevent camera shake in the following situations:
 - When shooting in a dark place without using the flash or in Slow Sync Mode (P.32)
 - When shooting with the zoom

Checking the Focus and Shooting (Half-press)

When you press the shutter release button halfway (half-press), the autofocus function is triggered to determine the focal distance. Subsequently press it all the way down (full-press) to shoot. This is useful when the subject is not in the middle (see P.28).

- 1. Make sure the power is on, then turn the Mode Dial to .**

For how to turn the power on, see P.21.

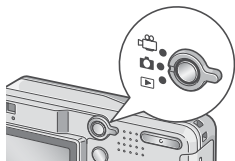

- 2. Compose your shot either by looking through the Viewfinder or at the LCD Monitor.**



- 3. Since the focus is adjusted at the center of the screen, position the subject at the center of the screen and half-press the shutter.**

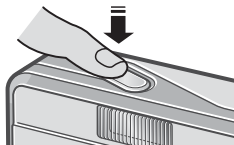

Once focused, the exposure and white balance are fixed.

If the automatic focusing fails, the crosshairs in the center of the LCD monitor turn red and the auto-focus lamp in the upper left of the viewfinder blinks in green.

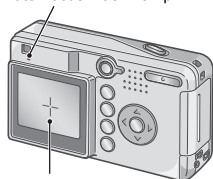

Auto Focus/Flash Lamp



| | Color of crosshairs | Auto Focus/Flash Lamp | |
|------------------|---------------------|---|---------------|
| Before focusing | White |  | Off |
| Focused | Green |  | On (green) |
| Focusing failure | Blink (red) |  | Blink (green) |

4. Gently press the shutter button all the way.

The still image you have taken freezes for a moment on the LCD Monitor and is recorded.

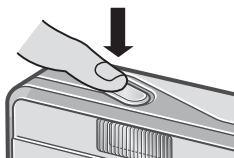

Note

- Press gently to prevent camera shake when you press the shutter release button.
- The  mark indicates that blurring may occur. Hold the camera still and focus the camera again.
- When the [LCD CONFIRM] is set to OFF in the setup screen, the still image shot will not be displayed on the LCD monitor.



Reference

For how to change the image confirmation time, see P.95.

When the Subject is not Centered (Shooting with Focus-lock)

When your subject is not in the center of your composition, compose your photo after focusing. (Focus-lock)

Example: Taking a photograph of the castle in the background with the camera focused on a person in front.

Shooting range

Subject to be focused on

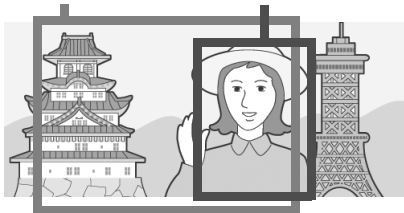

Final still image

- 1. Make sure the power is on, then turn the Mode Dial to .**

For how to turn the power on, see P.21.

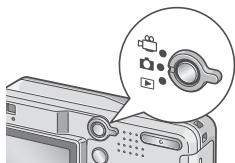

- 2. Put the subject of your photo right in the center of the LCD Monitor or the Viewfinder and press the shutter button half-way.**



3. With the shutter half-pressed, move the camera and compose your shot.
4. Gently press the shutter button all the way.

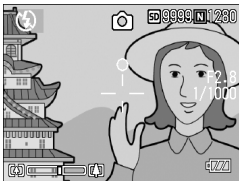

Note



At macro shooting, the AF target shift function allows you to lock the focus without moving the camera. This function is useful when a tripod is used.





Reference

- For details about macro shooting, see P.31.
- For details about the AF target shift function, see P.61.

Using the Zoom Function

If you use the  (Wide angle)/  (Telephoto) button, you can alter the size of the subject in your photo without having to change your distance from it.

By pressing the  button, the field in the LCD monitor and the viewfinder becomes wider. By pressing the  button, the subject you see in the LCD monitor and the viewfinder becomes larger.

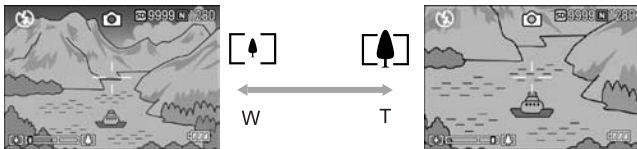

1. With the camera ready to shoot, press the  button or the  button.

You can check the Zoom status on the Zoom Bar of the LCD monitor.

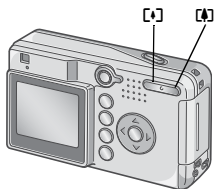

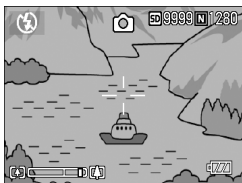

2. Compose your picture and half-press the shutter release button.
3. Press the shutter release button all the way.



Note

Using the Digital Zoom

Digital zooming enables you to enlarge the subject more than the maximum magnification (x3) that can be specified by pressing the  (Telephoto) button (up to x3.6).

For digital zooming, release the  button once when the zoom reaches the limit on the  (Tele) end on the Zoom Bar, and then hold the button down again.

Shooting Close-Ups (Macro-Mode)

Using the  (Macro) button allows you to take a tight close-up (Macro Photo). It is good for shooting small subjects because you can get up to one centimeter (1/2 inch) away.



- 1. With the camera ready to shoot, press the  button.**

 is displayed momentarily in a large size at the center of the LCD monitor and then at the upper part.

- 2. Compose your picture and half-press the shutter release button.**

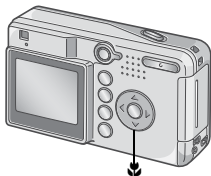

- 3. Press the shutter release button all the way.**

To get out of Macro Mode, press the  button again.

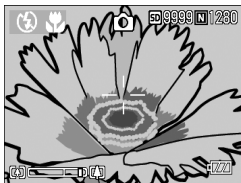

Note





- The zoom function enables macro shooting from the front end of the lens barrel to the following distance:
In Wide-Angle (W): Min. Approx. 1cm.
In Telephoto (T): Min. Approx. 16cm.
- During Macro Shooting, the Viewfinder cannot be used. Use the LCD Monitor.
- The AF target shift function enables you to lock the focus for macro shooting only by button operation without moving the camera. This function is useful for shooting on a tripod. (P.61)

⚡ Using the Flash

Press the ⚡ (Flash) button to switch between flash modes. By default, your camera is set to Flash Off.

From the front edge of the lens, flashlight reaches about 0.17 to 3.0 m (W) or about 0.16 to 2.0 m (T) when ISO sensitivity is set to AUTO.

Flash Modes

| | | |
|---|-------------------|---|
|  | Flash Off | The flash will not fire. |
|  | Auto | When your subject is poorly lit or backlit, the flash fires automatically. |
|  | Red-eye reduction | Reduces the red-eye phenomenon, in which people's eyes appear red when shooting images of people. |
|  | Forced Flash | The flash fires, whatever the light conditions are, when you shoot. |
|  | Slow Synchro | The flash fires with the shutter speed slowed. (Slow Synchro) |

1. Turn the Mode Selector to .

2. Press the ⚡ (Flash) button to switch between flash modes.

The Flash mode mark appears momentarily in a large size at the center of the LCD monitor and then is displayed at the upper left.

During flash charging, the flash lamp keeps blinking. Once the flash is charged, the lamp goes off and it is possible to shoot.













Note

- The settings are saved until you press the ⚡ (Flash) button to change them.
- When shooting movies or in Multi-Shot mode, the flash turns off.
- When the flash is turned on, in the case, the camera fires a preliminary flash just prior to the main flash.
- If you are using the camera on AA alkaline batteries, the LCD Monitor is turned off during flash charging.

Shooting with Scenery-Matching

If you use the Scene Mode, you can select from among six types of still image modes and shoot automatically with optimal settings for that kind of scene.

| | | |
|---|------------------|--|
|  | PORTRAIT | Use when taking portrait pictures. |
|  | SPORT | Use when taking pictures of moving objects. |
|  | LANDSCAPE | Use when you are taking scenery pictures with abundant greens or blue sky. |
|  | NIGHTSCAPE | Use when shooting night scenes. You can also shoot with persons in the frame. |
|  | TEXT MODE | Use when capturing text images, for example, notes written on the whiteboard at a meeting. |
|  | HIGH SENSITIVITY | Use when taking pictures in dimly lit places. Also, LCD monitor becomes brighter. |

1. Turn the Mode Selector to .
2. Press the  button.
The still image mode selection screen appears.
3. Press the  button to move to the SCENE menu.
4. Press the  buttons to move the orange rectangle to the mode you want to select.
5. Press the OK button.

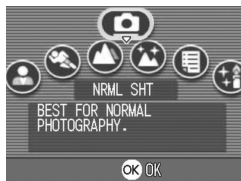

The Mode's symbol is displayed on the upper part of the LCD monitor.

6. Press the shutter release button.

If you press the  button, the still image mode selection screen appears and you can change the mode.

To return to ordinary shooting mode, on the still image mode selection screen, press the  button to select [Ordinary Shooting], and then press the OK button.



Reference

- For how to change PIC QUALITY/SIZE, see P.57.
- For how to change to density in TEXT Mode, see P.56.
- For combination of Scene Mode and the functions, see P.135.

Playing Back

Checking the image you just took (Quick Review)

You can view the image you just took on the LCD monitor. If you are not pleased with the way the photo came out, you can erase it then and there.





1. While still in the Still Image Mode, press the  (Quick Review) button.

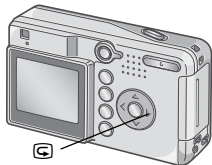

The last image you took is displayed on the LCD monitor.

Press  (Quick Review) again and the camera is ready to shoot.





To enlarge the image displayed

1. Press the  (Enlarged View) button.
2. Press the     buttons to move the rectangle to the part you want to enlarge.

To return to the original display, press the  button for the actual size and then the  button.



To erase the image displayed

1. Press the  (Delete) button.
2. Press  to select [DELETE].
3. Press the OK button.



Note

- Once the power is turned off, the image you took cannot be displayed in the still image mode even if you press the  button.
- If you use Quick Review to view the image taken in Text mode (see P.33), the displayed image may have slightly lower quality than the recorded one.

Viewing Your Images

In the Playback Mode you can check still images you have taken. You can also delete or zoom in on them.

1. Turn the Mode Selector to (Playback Mode).

The camera switches to Playback mode and the last still image you took is displayed.

You can view your pictures in order by using the  button.

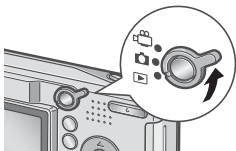

To Previous

To Next



Note

Where images are played back from

When no SD memory card is inserted, the camera plays back from the internal memory.
When an SD memory card is inserted, it plays back from the SD memory card.



Reference

For how to playback movies, see P.76.

Thumbnail Display

You can view your images in sets of six.
You can then select an image to erase or magnify.

1. Turn the Mode Selector to  (Playback Mode).

The last image you took is displayed.

2. Press the  (Thumbnail Display) button.

The screen is split into six sections with six images displayed.

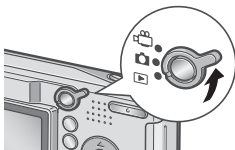

To display just one photo

1. Use the    buttons to select an image.
2. Press the  (Enlarged View) button.

Selected still image

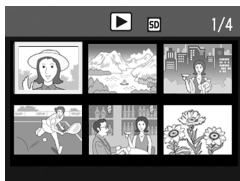

Reference

For how to erase the selected image, see P.41.

Q Magnifying Images

You can enlarge a still image displayed on the LCD Monitor.

An image can be enlarged up to 8 times when its size is 2304x1728, up to 6.7 times when its size is 1600x1200 or 1280x960, and up to 3.4 times when its size is 640x480.

1. Turn the Mode Selector to  (Playback Mode).

The last image you took is displayed.

2. Press the  buttons to display the still image you want to enlarge.

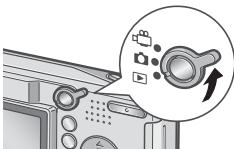



3. Press the Q (Enlarged View) button.

The still image is enlarged.

The enlargement ratio changes each time you press the Q button or the  button.



To move to a part you want to magnify.

1. Move around using the    buttons.



To return the image to its original size.

1. Press the OK button.



Note

You can also magnify a displayed image in the Quick Review mode.

Viewing on a Television

You can view still images you have taken on a TV screen. The camera displays everything on the TV screen just as it would on the LCD Monitor.

To use your television for viewing, connect your camera to the television with the VIDEO cable that came with your camera.

To view still images on a television, follow the steps below.

- 1. Securely connect the VIDEO cable to the Video In terminal on the television.**

Connect the plug of the VIDEO cable to the video input terminal of the TV unit (yellow).

Video input terminal (yellow)

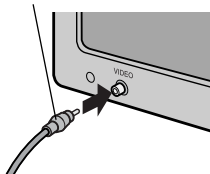

- 2. Make sure the camera power is off.**
- 3. Open the camera terminal cover, and then securely connect the VIDEO cable to the Video Out terminal.**

- 4. Set the television to "Video" mode. (Set the input to "Video".)**

For details, see the documentation that came with the television.

- 5. Turn the Mode Selector to  (Playback Mode).**

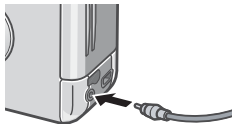

6. Turn your camera on by pressing the power button.

Connecting the VIDEO cable to the camera turns off the LCD monitor display.

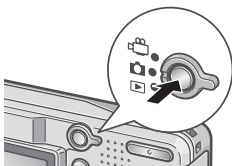

Note

- If you connect the VIDEO cable to your video recorder's In terminal, you can record what you have shot onto video.
- Your camera is set to NTSC playback format (used in Japan and other countries) for use with television equipment, etc. If the equipment you want to connect to uses PAL format (used in Europe and else-where), then switch your camera to PAL format in the Setup Menu before connecting.



Reference

For how to change the video out mode, see P.102.









Erasing



Erasing Unwanted Images

You can erase unwanted images from the internal memory or SD Memory Card.

You can erase them in the following three ways:

- One file at a time
- Deleting all frames at once
- Select multiple frames and erase together

1. Turn the Mode Selector to  (Playback Mode).
2. To erase images one at a time, press the   buttons to display the image you want to erase.
3. Press the  (Delete) button.
4.   Press the   buttons to select [DELETE ONE] or [DELETE ALL].

If you selected [DELETE ONE], you can also change the image for deletion with the   buttons.

5. Press the OK button.

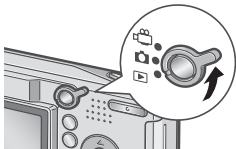



If you selected [DELETE ONE]:

6. The display indicates deletion is in progress; once finished, it returns to the screen in step 4.

If you selected [DELETE ALL]:

6. You will be prompted to confirm that you want to erase; if so, press the  button to select [Yes], and then press the OK button.

Erasing Multiple Frames at One Time

1. Turn the Mode Selector to  (Playback Mode).
2. Press the  (Thumbnail Display) button.

The screen is divided into a display of six thumbnails.

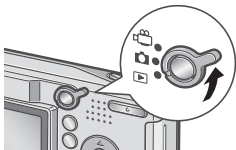



3. Press the    buttons to select the image you want to erase and press the  (Delete) button.

The trash symbol is displayed in the upper left corner of the image.

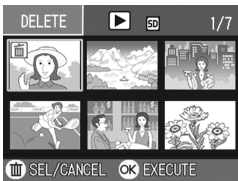
4. Repeat Step 3. to select all the still images you wish to erase.



If you selected an image by mistake, you can deselect it by selecting the image and pressing the  (Delete) button again.

5. Press the OK button.
6. Press the  button to select [YES] and then press the OK button.

The display indicates deletion is in progress; once finished, the Thumbnail Display screen returns.



Chapter 2

A Variety of Shooting Techniques/Playback

| | |
|--|----|
| Direct Printing | 44 |
| A Variety of Shooting Techniques..... | 49 |
| Shooting with Multi-Shot..... | 71 |
| Shooting/Playing Back Movies | 75 |
| Other Functions Available in Playback Mode..... | 77 |

Direct Printing

Direct Print Function

The Direct Print standard enables direct printing from a camera to a printer, by connecting them via a USB cable. Photos can be printed quickly and easily from your digital camera without using a computer.



Caution

- You cannot print movies (.AVI) with this function.
- Some printer does not support images taken in Text mode (TIFF). Even when TIFF images are printed, their printed contents cannot be guaranteed.



Note

- This camera uses PictBridge, an industry standard for Direct Printing.
- Your printer must comply with the PictBridge to use the Direct Print function. For support information, see the documentation that came with the printer.

Connecting the Camera to a Printer

Connect your camera to a printer using the USB cable provided.

- 1. Make sure the camera power is off.**
- 2. Make sure the printer power is off.**
Load paper into the printer and check that the printer is ready to print.
- 3. Connect one end of the USB cable provided to the USB port of your printer.**
- 4. Connect the other end of the USB cable to the USB terminal on your camera.**
- 5. Turn the printer power on.**



Note

To disconnect the camera from the printer, check that the power is off on both units before disconnecting the USB cable between them.

Printing Still Images

You can send still images from the camera to a PictBridge compatible printer to print them.

Still images are sent from the internal memory when no SD memory card is loaded or from an SD memory card when one is loaded.



Caution

Do not disconnect the USB cable during printing.



Note

If a printer error message appears during transmission, check the condition of the printer, and take the appropriate action.

Printing One or All Still Images

1. Check that the printer is ready for printing.

The "Connecting" screen appears.

2. Press the ADJ. button.

The "Connecting" screen appears. When the connection between the printer and the camera is established, the Direct Print playback mode screen appears. For some printers, the "Connecting" screen automatically appears before you press the ADJ. button.



3. Press the ◀▶ buttons to select an image for printing.

4. Press the ADJ. button.

5. Press the ▲▼ button to select [1 FILE] or [ALL FILES].

6. Press the OK button.

The Direct Print menu appears.



7. Press the ▲▼ buttons to select an item, and then press the ► button to display the detailed options screen.

If there are no options available for an item, the detailed options screen does not appear even if you press the ► button. Also, items that are not available on the printer do not appear.

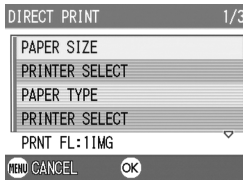

The following items are available:

| Item Name | Function |
|-----------------|--|
| PAPER SIZE | Sets the paper size. |
| PAPER TYPE | Sets the paper type. |
| LAYOUT | Sets the number of images printed on a sheet of paper. |
| DATE PRINT | Selects whether to print the date (shooting date). The date format can be set using the date/time option in the SETUP Mode. |
| FILE NAME PRINT | Selects whether to print the file name. |
| OPTIMIZE IMAGE | Selects whether to optimize the image data (still image) prior to printing on the printer. |

8. Press the ▲▼ buttons to select the detailed item, and then press the OK button.

The display returns to the Direct Print menu.

9. Repeat steps 7 and 8 to change the settings as required.

10. Press the OK button.

The selected still images are sent to the printer and the "Connecting" screen appears.

Press the MENU button to cancel the operation.

At the end of transmission, the display returns to the Direct Print playback mode screen and printing starts.



Printing Several Still Images

1. Check that the printer is ready for printing.

The "Connecting" screen appears.

2. Press the ADJ. button.

The "Connecting" screen appears.

When the connection between the printer and the camera is established, the Direct Print playback mode screen appears.

For some printers, the "Connecting" screen automatically appears before you press the ADJ. button.

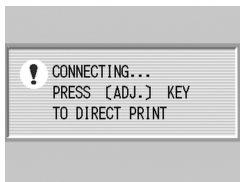



3. Press the (Thumbnail Display) button.

The screen is split into six sections with the still images displayed at a reduced size.

4. Press the buttons to select an image for printing.

5. Press the OK button.

6. Press the buttons to set the number of copies to print.

Press the  button to increase the number, or the  button to decrease it.

7. Press the buttons to select an image for printing.

8. Press the buttons to set the number of copies to print.

9. Repeat steps 7 and 8 to select all the still images to be printed and the number of copies for each.

10. Press the MENU button.

The Direct Print menu appears.



11. Press the ▲▼ buttons to select an item, and then press the ► button to display the detailed options screen.

If there are no options available for an item, the detailed options screen does not appear even if you press the ► button. Also, items that are not available on the printer do not appear.

For settings available, see P.46.

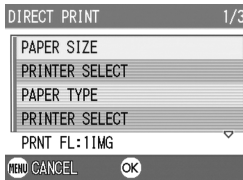

12. Press the ▲▼ buttons to select the detailed item, and then press the OK button.

The display returns to the Direct Print menu.

13. Repeat steps 11 and 12 to change the settings as required.

14. Press the OK button.

The selected still images are sent to the printer and the "Connecting" screen appears.

Press the MENU button to cancel the operation.

When all the selected still images have been sent from the camera to the printer, the camera display returns to the Direct Print playback mode screen.



Note

- Only images with a printer mark () are printed. When you cancel printing and then try to print again, make sure that the printer mark is on the images you want to print.
- The same still image can also be printed several times on a single sheet.
- The items available vary depending on the functions of the printer.
- To print images using the printer's default settings, select Printer Setting on the detailed options screen.

A Variety of Shooting Techniques

Using the ADJ. (Adjust) Button

The ADJ button allows exposure correction, white balancing, and ISO sensitivity setting by fewer operations. You can also register a function other than these adjustment functions to the ADJ button. If a frequently used function is registered, they can be set easily by fewer button operations.

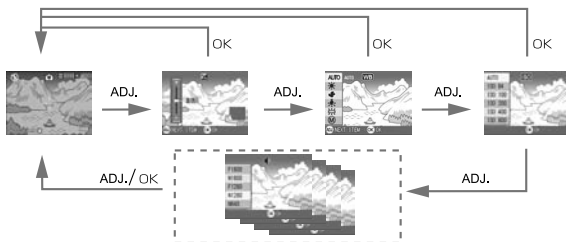

Use the SETUP menu to register a function to the ADJ button (P.93).

Adjustments Using the ADJ. Button

Adjustments that can be made with the ADJ. button differ between SCENE mode and Movie mode.

| | |
|-----------------------------------|--|
| Still Image Mode | Exposure control, white balance, ISO sensitivity |
| Movie Mode | White Balance |
| Scene Mode (Text Mode) | Density |
| Scene Mode (other than Text Mode) | Exposure control, white balance |



Reference

- Exposure Comp, see P.52.
- White Balance, see P.53.
- ISO Setting, see P.55.
- Text Density, see P.56.
- For how to set a function to the ADJ. button, see P.93.

Shooting Setting Menu

The Shooting Setting menu enables you to shoot pictures by setting the items listed in the table below.



* Among the choices listed in the table below, default values at purchase are enclosed in [].

| Setting | Option | Refer to |
|------------------|--|----------|
| PIC QUALITY/SIZE | F2304, N2304, F1600, N1600, F1280, [N1280], N640 | P.57 |
| FOCUS | [AF], MF, SNAP, ∞ | P.59 |
| PHOTOMETRY | [MULTI], CENTRE, SPOT | P.63 |
| SHARPNESS | SHARP, [NORMAL], SOFT | P.62 |
| CONT. MODE | [OFF], CONT, SCONT, MCONT | P.71 |
| TIME EXPOSURE | [OFF], 1, 2, 4, 8 seconds | P.65 |
| INTERVAL | _____ | P.66 |
| DATE IMPRINT | [Off], Date, Date and Time | P.69 |
| EXPOSURE COMP. | -2.0 to +2.0 | P.52 |
| WHITE BALANCE | [AUTO], (Daylight), (Overcast), (Tungsten light), (Fluorescent light), (One Push) | P.53 |
| ISO SETTING | [AUTO], ISO64, ISO100, ISO200, ISO400, ISO800 | P.55 |
| SLOW SHUTTER LMT | [OFF], ON | P.68 |
| RESTORE DEFAULTS | _____ | P.70 |



Note

The SETUP menu can be accessed from within the Shooting Setting menu. For details, see P.88.

Using the Shooting Setting Menu

1. **With the camera ready to shoot, press the MENU button.**
The Shooting Setting menu appears.

2. **Press the ▲▼ buttons to select the desired item.**

The setting items are provided on three screens.

When the ▼ button is pressed at the bottom item, the next screen appears.

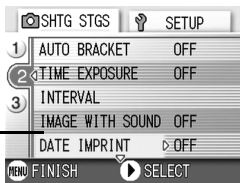

To select a screen by screen number:

1. Press the ◀ button to select a screen number on the left of the screen.
2. With the screen number selectable, press the ▲▼ buttons to switch between screens.
3. After selecting the screen, press the ▶ button to return to the setting item selection step.

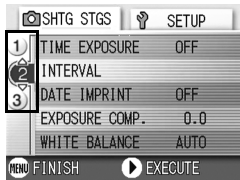

3. **After selecting a setting item, press the OK or ▶ button.**

Choices for the setting item are displayed.

4. **Press the ▲▼ buttons to select a choice.**

5. **Press the OK or ◀ button.**

6. **If you pressed the ◀ button in step 5, press also the MENU button.**

The Shooting Setting menu disappears and the camera becomes ready for shooting.

Changing the Exposure (EXPOSURE COMP.)

The exposure setting allows you to select brightness levels for your shots. Normally, if your subject is centered, backlight compensation is automatically activated, and you can shoot with correct exposure.

However, in the following cases, or when you intentionally want to change the exposure, you can change the exposure setting. Exposure can be specified in the range from -2.0 to +2.0. Setting the level higher (+) makes pictures brighter and lower (-) makes pictures darker.

For Backlighting

When the background is particularly bright, the subject will be dark (underexposure). In this case, set the exposure level higher (+).

When your subject is whitish

It will turn out entirely dark (underexposure). Set the exposure level higher (+).

When your subject is darkish

It will turn out entirely bright (overexposure). Set the exposure level lower (-). The same happens when you take photos of people in a spotlight.

To change the setting, use either the Shooting Setting menu or the ADJ. button.

This section explains easy ways with the ADJ. button.

When using the Shooting Setting menu, see "Using the Shooting Setting Menu" (P.51).

1. Turn the Mode Selector to .
2. Press the ADJ. button.
The Exposure Compensation bar appears.
3. Press the ▲▼ buttons and specify a value.
4. Press the OK button.

Exposure Compensation settings are completed and the setting value appears in the right-hand portion of the screen.







Note



When shooting in particularly bright places, you may fail in preventing overexposure. In that case, the [!AE] symbol will be displayed.

Using Natural and Artificial Lighting (WHITE BALANCE)

Adjust the white balance so that a white subject may be reproduced as white. At purchase, the White Balance is set to "AUTO"; normally you do not need to change the setting, but if the camera is having difficulty determining the white balance when shooting an object of a single color or under several light sources, you can change the setting.

| Types of Modes You Can Select | | |
|---|-------------------|---|
| Symbol | Mode | Description |
| AUTO | Auto | Make adjustments automatically. |
|  | Daylight | Select when shooting outdoors (Sunny) and White Balance fails to adjust properly. |
|  | Overcast | Select when shooting in cloudy weather or shade and the White Balance fails to adjust properly. |
|  | Tungsten light | Select when shooting under tungsten light and White Balance fails to adjust properly. |
|  | Fluorescent light | Select when shooting under fluorescent light and White Balance fails to adjust properly. |
|  | One-push | Manually set White Balance. |





To change the setting, use either the Shooting Setting menu or the ADJ. button. This section explains easy ways with the ADJ. button. When using the Shooting Setting menu, see "Using the Shooting Setting Menu" (P.51).

1. Turn the Mode Selector to .
2. Press the ADJ. Button three times.
The White Balance menu appears.
3. Press the  buttons to select a mode other than .
4. Press the OK button.

White Balance settings are completed and the symbol appears on the screen. This setting will be used for shooting until you change it.



Setting the White Balance Manually (One Push)

1. Turn the Mode Selector to .
2. Press the ADJ. Button twice.
The White Balance menu appears.
3. Press the   buttons to select  (One Push).
4. Point the camera at a piece of paper or something white under the lighting conditions for your picture.

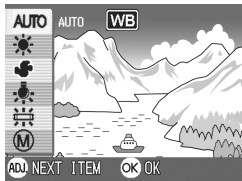

5. Press the  button.

White Balance is set.

6. Press the OK button.

White Balance settings are completed and the symbol appears in the upper left of the screen.

This setting will be used for shooting until you change it.

If you press the  button in step 5, the screen refreshes to show the White

Balance settings made. If the result is not as expected, repeat steps 4 and 5 to change the settings as many times as required.



Note

- In Auto Mode, white balance may not be adjusted correctly for a subject mostly dark. In this case, add something white as the subject.
- When shooting with flash, white balance may not be adjusted correctly in Daylight, Overcast, Tungsten light, or One Push mode. In this case, switch to Auto Mode for shooting with flash.

Caution

When shooting with flash in a mode other than Auto, the white balance may not be adjusted correctly.

Changing Sensitivities (ISO SETTING)



The ISO sensitivity indicates how sensitive to light the film is. A greater value means higher sensitivity. High sensitivity is suitable for shooting an object in a dark place or moving fast and suppresses blurring. However, the images become rough.

For higher or lower sensitivity, you can select from the following six levels:

AUTO, ISO64, ISO100, ISO200, ISO400, ISO800

A digital camera can automatically vary the sensitivity according to the distance, brightness, zoom, and macro (AUTO). Usually use your camera in the AUTO mode.

To change the setting, use either the Shooting Setting menu or the ADJ. button. This section explains easy ways with the ADJ. button. When using the Shooting Setting menu, see "Using the Shooting Setting Menu" (P.51).

1. Turn the Mode Selector to .
2. Press the ADJ. Button three times.
The ISO Sensitivity menu appears.
3. Press the   buttons to select an ISO setting.

You can also press the shutter button in this state.

4. Press the OK button.

The ISO Sensitivity settings are completed and the setting value appears in the right-hand portion of the screen.

This setting will be used for shooting until you change it.

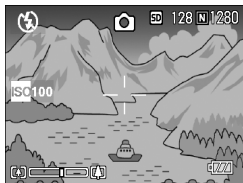
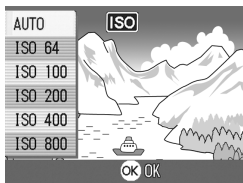

Note





In Wide-angle Zoom mode, when the ISO Sensitivity is set to Auto, the sensitivity is equivalent to ISO160 with flash or ISO100 without flash.

Changing Shading for Shooting Text (DENSITY)

You can change the shading of text for shooting in Text Mode of Scene Mode.

You can select from DEEP, NORMAL and LIGHT.

To change the setting, use either the Shooting Setting menu or the ADJ. button. This section explains easy ways with the ADJ. button. When using the Shooting Setting menu, see "Using the Shooting Setting Menu" (P.51).

1. Turn the Mode Selector to .
2. Press the  button.
The still image mode selection screen appears.
3. Press the  button to move to the SCENE menu.
4. Press the  buttons to select the text mode and then press the OK button.



5. Press the ADJ. button.
The Text Density menu appears.
6. Press the  buttons to select the desired density setting.
You can also press the shutter button in this state.
7. Press the OK button.

Text Density settings are completed.

The Text Density setting value does not appear on the screen. This setting will be used for shooting until you change it.



Reference

For how to shoot text, see P.33.





In response to the digital network system provides a variety of s choose from. Ricoh offers a range advanced solutions to business needs. what looking for stand-alone printing, faxing, scanning multifunctional products rely on our technology your business ahead!

Choosing Picture Quality Mode/Image Size (PIC QUALITY/SIZE)

The size of a stored still image and movie file depends on picture quality and size settings.

In Picture Quality Mode, there are two types, N (Normal) and F (Fine).

| Types of Modes You Can Select | | |
|---|-------------|---|
| Symbol | Mode | Description |
|  | Normal Mode | The compression ratio is high, resulting in a small file. Normally, shooting is done in this mode. |
|  | Fine Mode | The compression ratio is low, resulting in a large file, but the picture quality is better than in Normal Mode. |

Combining Picture Quality Mode and Image Size.

| | | Size | | | |
|------|------------|--------------|-------------|------------|-----------|
| | | 2304 X 1728 | 1600 X 1200 | 1280 X 960 | 640 X 480 |
| Mode | F (Fine) | F2304 | F1600 | F1280 | - |
| | N (Normal) | N2304 | N1600 | N1280 | N640 |

Figures inside the bold frame indicate those shown on the screen.



Reference

For internal memory/SD memory card recording capacities, see P.138.

1. Turn the Mode Selector to .

2. Press the MENU button.

The Shooting Setting menu appears.

3. Press the  button to select [PIC QUALITY/SIZE] and press the OK or  button.

4. Press the   buttons to select a picture quality/size.

5. Press the OK or  button.

Picture Quality/Image Size settings are completed.

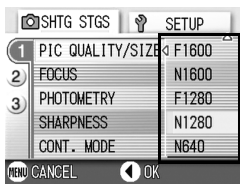

Still Image Mode

6. If you pressed the  button in step 5, press also the MENU button.

The Shooting Setting menu closes and the setting value appears on the upper right of the screen.

This setting will be used for shooting until you change it.



Movie Mode

Manual Focus Shooting (FOCUS)

When Auto-Focus does not focus as desired, you can focus manually (Manual Focus).

Manual focusing allows shooting at a fixed distance. When using a fixed shooting distance, it can be set to either Snapshot or Infinity (∞).



Note

- Manual focus cannot be used in Scene Mode.
- Manual focusing can focus the camera also on an object that requires macro shooting.

1. Turn the Mode Selector to .

2. Press the MENU button.

The Shooting Setting menu appears.

3. Press the  button to select [FOCUS] and press the OK or  button.

4. Press the   buttons to select [MF].

5. Press the OK or  button.

Focus settings are complete.

6. If you pressed the  button in step 5, press also the MENU button.

The Menu closes and "MF" is displayed on the screen.

Pressing the OK button alternates the display between the focus bar and the zoom bar. For manual focusing, display the focus bar by pressing the OK button.

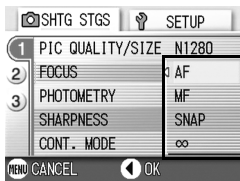

7. Press the **[▲][+]** buttons to focus the camera.

If you press the **[▲]** button, the focus moves further away.

If you press the **[+]** button, the focus moves closer.

Manual Focus is used for shooting until you change the settings.



Note

- By pressing the OK button, you can operate the zoom bar with the **[▲][+]** buttons.
- At interval shooting, the OK button cannot be used to operate zooming or switch to manual focusing.

Shooting at a Fixed Distance

The shooting distance can be set to short distance or infinity.

Infinity is useful to shoot a distant view.

To shoot with the shooting distance fixed, follow the steps below.

1. Turn the Mode Selector to

2. Press the MENU button.

The Shooting Setting menu appears.

3. Press the **▼** button to select **[FOCUS]** and press the OK or **▶** button.

4. Press the **▲▼** buttons to select **[SNAP]** or **[∞]** (Infinity).

Selecting **[SNAP]** will fix the shooting distance to 2.5 meters.

Selecting **[∞]** will fix the shooting distance to infinity.

5. Press the OK or **◀** button.

Focus settings are complete.

6. If you pressed the **◀** button in step 5, press also the MENU button.

The Shooting Setting menu closes and the setting value appears on the screen.

This setting will be used for shooting until you change it.

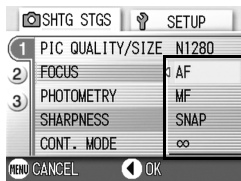

Using the AF Target Shift Function

At macro shooting, the AF target shift function allows you to lock the focus (P.28) by using the **▲▼◀▶** buttons on the camera without moving the camera.

This is useful for macro shooting on a tripod with locked focus.

The AF target shift function allows you to shift the cross at the center of the LCD monitor to the subject with the **▲▼◀▶** buttons for focusing.

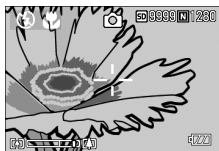

Press the **◀** button to shift the cross (focus) to the left

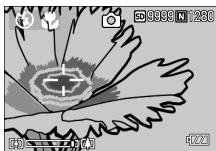

1. With the camera ready to shoot, press the **📷** button.

The Macro symbol is displayed at the top of the screen.

2. Press the **ADJ. Button** four times.

Press five times if the ADJ. button has the fourth function.

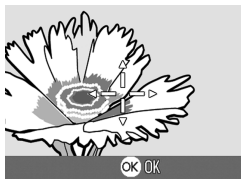

3. Shift the cross to the subject with the **▲▼◀▶** buttons for focusing.

4. Press the **OK** button.

5. Half-press the shutter button

The camera focuses on the cross.





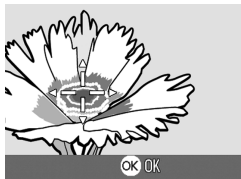

6. Gently press the shutter button all the way.

Until you get out of the Macro mode, the AF target shift function automatically focuses the camera on the set position.



Changing the Edge Quality of Still Images (SHARPNESS)

You can change the definition of your still images to either sharp or soft.

1. Turn the Mode Selector to .
2. Press the MENU button.
The Shooting Setting menu appears.
3. Press the  button to select [SHARPNESS] and press the OK or  button.
4. Press the   buttons to select the desired setting.
5. Press the OK or  button.
Sharpness settings are complete.



6. If you pressed the  button in step 5, press also the MENU button.



The Shooting Setting menu disappears and the setting value appears. This setting will be used for shooting until you change it.



Changing the Light Metering (PHOTOMETRY)

You can change the metering method (the range to use for metering) to determine the exposure value.

There are three Light Metering Methods available: MULTI, CENTER, and SPOT.

| Types of Modes You Can Select | | |
|---|--------|---|
| Symbol | Mode | Description |
| (No Symbol) | MULTI | The entire shooting range is divided into 256 partitions, and subjected to photometry for overall decision. |
|  | CENTER | The light metering is determined by a measurement of the whole, with the central part emphasized. Use this when the brightness of the center and surroundings are different. |
|  | SPOT | Light metering is determined by measuring only the central part. Use this setting when you want to use the brightness of the center. It is useful if there is marked difference in contrast or backlighting. |

1. Turn the Mode Selector to .
2. Press the MENU button.
The Shooting Setting menu appears.
3. Press the ▼ button to select [PHOTOMETRY] and press the OK or ► button.
4. Press the ▲▼ buttons to select the desired setting.
5. Press the OK or ◀ button.
Light Metering Method setting is complete.
6. If you pressed the ◀ button in step 5, press also the MENU button.
The Shooting Setting menu closes and the setting value appears at the upper part of the screen.
This setting will be used for shooting until you change it.

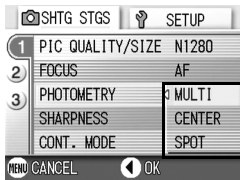

Using the Self-Timer

You can set the Self-timer to shoot after either two or ten seconds. A setting of two seconds is useful for preventing camera shake.

1. Turn the Mode Selector to .
2. Press the  (Self-timer) button.

The Self Timer mark appears momentarily in a large size at the center of the LCD monitor and then is displayed at the upper left.

The "10" to the right of the symbol indicates the number of seconds. In this case, if you press the shutter button, the camera will shoot after 10 seconds.



3. Press the shutter release button.

The focus is locked, the flash goes on, and the self-timer starts. Once the picture is taken, the self-timer mode is cleared.











Note

- Each press of the  (Self-timer) button, it selects a function in the following sequence: 10 sec, 2 sec, Self-timer Off, 10 sec, 2 sec.
- Self-timer settings are released when the power is turned off.
- When the self-timer is set to 2 seconds, the flash for self-timer does not fire.

Using Long Time Exposure (TIME EXPOSURE)

You can select an exposure time of 1, 2, 4 or 8 seconds.

By using long time exposure, you can capture the track of moving subjects such as fireworks and car lights, when you shoot a night scene.

1. Turn the Mode Selector to .
2. Press the MENU button.
The Shooting Setting menu appears.
3. Press the  button to select [TIME EXPOSURE] and press the OK or  button.
4.   Press the   buttons to select the exposure time.
5. Press the OK or  button.
This completes the setting of time exposure.
6. If you pressed the  button in step 5, press also the MENU button.

The Shooting Setting menu disappears and the setting value appears.

This setting will be used for shooting until you change it.

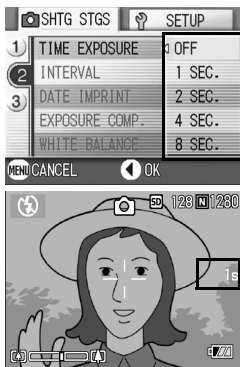



Note









- When using long time exposure, the shutter speed may go down and images may be blurred. Hold the camera securely by both hands or use a tripod for shooting.
- While shooting with long time exposure, the LCD Monitor display turns off.

Shooting Pictures Automatically at Set Intervals (INTERVAL)

You can set the camera to automatically take pictures at fixed intervals.

You can set the shooting interval at any length from 30 seconds to 3 hours, in increments of 30 seconds.

1. Turn the Mode Selector to .
2. Press the MENU button.
The Shooting Setting menu appears.
3. Press the  button to select [INTERVAL] and press the OK or  button.

4. Press the   buttons to specify the length of time.
5. Press the  button to move to the minutes setting, then use the   buttons to set the minutes.
6. Press the  button to move to the seconds setting, then use the   buttons to set the seconds.
7. Press the OK button.

The setting of interval shooting is completed and "Interval" appears on the upper-right of the screen.

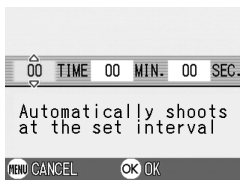
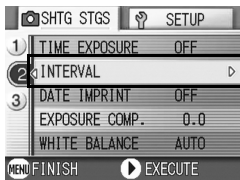

8. Press the shutter release button.

A picture is taken every time the fixed interval elapses.

9. To stop shooting, press the OK button.

Interval Shooting settings are cleared when the power is turned off.



Note

- In step 5, press and hold either the ▲ or the ▼ button to quickly raise or lower the setting value for minute.
- If you use batteries for power, you may exhaust the batteries. Using the AC Adapter (sold separately) is recommended.
- Even during Interval Shooting, if you press the shutter button, the camera will shoot as usual. However, Interval Shooting Mode is unaffected. After shooting, once the time specified in Interval Shooting elapses, the next shot is taken.
- Depending on Picture Quality Mode and Flash Mode settings, the shooting interval may become longer than the time set.
- When Interval Shooting is on, even when Multi-Shot is set to [CONT] or [MCONT], consecutive shooting is automatically switched off.





Limiting the Shutter Release Speed (SLOW SHUTTER LMT)

By setting this function to [ON], the maximum shutter release speed can be limited to the following:



In Wide-Angle (Wide): 1/8 second

In Telephoto (T): 1/30 second

When the function is set to [OFF], the maximum shutter release speed is 1 second.

1. Turn the Mode Selector to .
2. Press the MENU button.
The Shooting Setting menu appears.
3. Press the  button to select [SLOW SHUTTER LMT] and press the OK or  button.
4. Press the  buttons to select [ON] or [OFF].



5. Press the OK or  button.
The setting of shutter release speed limit is complete.
6. If you pressed the  button in step 5, press also the MENU button.
The Shooting Setting menu disappears and the setting value appears. This setting will be used for shooting until you change it.







Note

- When Time Exposure is set to ON, priority is given to Time Exposure.
- When Nightscape is selected in Scene Mode, priority is given to Nightscape.
- When the flash is in Slow Synchro mode, the longest shutter speed is one second.

Inserting the Date into a Still Image (DATE IMPRINT)

You can insert the date (YY/MM/DD) or the date and time (YY/MM/DD hh:mm) at the lower right of a still image.

1. Turn the Mode Selector to .
2. Press the MENU button.
The Shooting Setting menu appears.
3. Press the  button to select [DATE IMPRINT] and then press the OK or  button.
4. Press the  buttons to select the desired setting.
5. Press the OK or  button.
The Date Imprint settings are completed.

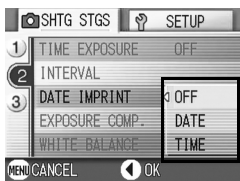

6. If you pressed the  button in step 5, press also the MENU button.

The Shooting Setting menu closes and  appears at the left part of the screen. This setting will be used for shooting until you change it.



Note

- If the date and time have not been set, DATE IMPRINT cannot be used. First make the date and time settings (P.100).
- DATE IMPRINT cannot be used with movies.
- A thumbnail image is not displayed with a date.

Returning the Shooting Setting Menu Settings to their Defaults (RESTORE DEFAULTS)

To return the Shooting Setting menu settings to their defaults, follow the steps below.

1. Turn the Mode Selector to .
2. Press the MENU button.
3. Press the ▲▼ buttons to select [RESTORE DEFAULTS] and press the OK or ► button.
4. Make sure that [YES] is selected, and then press the OK button.

The display indicates the camera is restoring the initial settings; once it is finished, the display returns to the Mode screen.

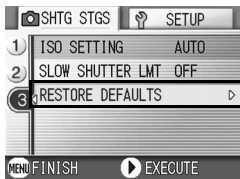

Reference

For a list of functions whose settings are not cleared by power-off, see P.137.

Shooting with Multi-Shot

If you switch to Multi-Shot, you can shoot consecutive images. Multi-shot can be classified into the following types:

CONT (Multi-Shot)

As long as you hold the shutter button down, pictures continue to be taken. The still images are recorded one file each, just as in normal shooting.

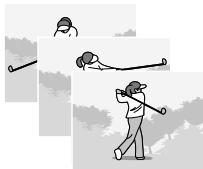

S (Stream) Multi-Shot

With just full-press of the shutter, you can take 16 consecutive shots at intervals of 1/7 second (in about 2.2 seconds). The 16 still images are grouped together as a set and are recorded as one image file (2304 x 1728 pixels).

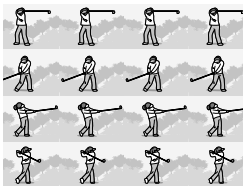

M (Memory-reversal) Multi-Shot

The camera memorizes the scene while you hold the shutter release button down, and once you release it the previous 2.2 seconds of shots are recorded.

The 16 still images are grouped together as a set and are recorded as one image file (2304 x 1728 pixels).

2. The camera records for about 2.2 seconds ahead

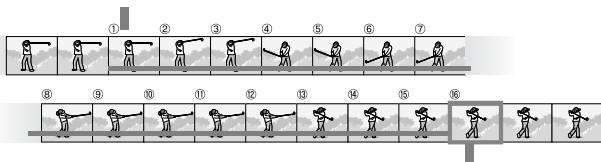

1. If you release the shutter release button here...



Note

- When shooting with S Multi- or M Multi-Shot, the ISO sensitivity is fixed to AUTO even if it is set to 64,100.
- The maximum number of images that can be shot in the Multi-Shot mode depends on the image size setting as follows:

| F2304 | N2304 | F1600 | N1600 | F1280 | N1280 | N640 |
|-------|-------|-------|-------|-------|-------|------|
| 2 | 2 | 2 | 2 | 4 | 4 | 4 |

1. Turn the Mode Selector to .
2. Press the MENU button.
The Shooting Setting menu appears.
3. Press the ▼ button to select [CONT] and press the OK or ► button.
4. Press the ▲▼ buttons to select [CONT], [SCONT], or [MCONT].
5. Press the OK or ◀ button.

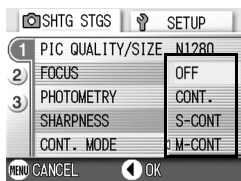

6. If you pressed the ◀ button in step 5, press also the MENU button.

The Shooting Setting menu closes and the symbol is displayed at the top of the screen.



CONT

7. Compose your picture, then press and hold the shutter button.

As long as you hold the shutter button down, pictures continue to be taken.

8. Release your finger from the shutter release button to stop memorizing.

To playback consecutive images shot in Multi-Shot mode, turn the camera to playback mode (see P.34) and select the still image with the ◀▶ buttons for playback.

SCONT (S Multi-Shot)

7. Compose your picture, then press the shutter button.

16 pictures are taken automatically.

MCONT (M Multi-Shot)

7. Compose your picture, then press and hold the shutter button.

The camera memorizes the scene while you hold the shutter release button down.

8. Release your finger from the shutter release button.

The camera stops memorizing and the previous 16 still images (in about 2.2 seconds) are recorded as one still image.

Note

- When you want to return to normal single-shot shooting, follow step 1 through 3, select [OFF] in step 4, and press the OK button.
- In MCONT mode, if you release the shutter button within 2.2 seconds from the time you first pressed it, the shots from the time you pressed the shutter until you released it will be recorded (the number of consecutive shots will be less than 16).
- Flash is switched to OFF.

Viewing an S Multi-Shot or M Multi-Shot Still Image in Enlarged Display Mode

While still images (16 frames in a file) taken by SCONT or MCONT are displayed, one of the 16 frames can be displayed in an enlarged view. While viewing an enlarged frame image, you can switch between frames.

To view a shot from S Multi-Shot or M Multi-Shot still images in Enlarged Display Mode, follow the steps below.

1. Press the Playback button.

The last shot taken is displayed.

2. Press the ◀▶ buttons to display an S Multi-Shot or M Multi-Shot still image.

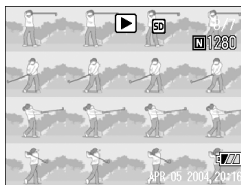

3. Press the Q (Enlarged Display) button.

The first frame of consecutive images is displayed in Enlarged Display Mode.

The shot position bar appears at the lower part of the LCD monitor.

Press the ◀▶ buttons to feed the shot.

To return to the 16-shot display, press the OK button.

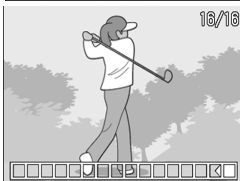

Note

Press the DISP. button to turn on or off the bar display at the lower part of the LCD moitor.



Reference

For how to shoot images in S Multi-Shot or M Multi-Shot mode, see P.71.

Shooting/Playing Back Movies

Shooting Movies

You can shoot movies.

You can select the image size, either 320 x 240 or 160 x 120 pixels. Each movie you shoot is recorded as one AVI file.

1. Turn the Mode Selector to  (Movie Mode).
2. Press the shutter release button.
The camera starts recording.
Recording continues until you press the shutter button again.
3. Pressing the shutter button again stops recording.



Caution

- You can not record sounds.
- The maximum recording time per shooting depends on your card. Even within the maximum recording time, some card may end shooting.

Note

- The flash cannot be used.
- While shooting movies, only Digital Zoom can be used.
- At the time you press the shutter button in Step 2, the shot comes into focus and the white balance is automatically fixed.
- The remaining recording time may not change uniformly because it is recalculated from the remaining memory capacity during movie recording.

Reference

- For how to change the image size for movies, see P.57.
- For how to use the Digital Zoom, see P.30.

Playing Back Movies

To playback movies, follow the steps below.

1. Turn the Mode Selector to (Playback Mode).

The last shot taken is displayed.

For movies, the first frame is displayed as a still image.

2. Move to the movie you want to view using the buttons.

Press the  button to display the next file.







Press the  button to display the previous file.

3. Press the OK button.

Playback begins.

The elapsed playback indicator or the elapsed time is displayed on the LCD Monitor.



| | |
|----------------|---|
| Fast Forward | Press the  button during playback. |
| Rewind | Press the  button during playback. |
| Pause/Playback | Press the OK button. |
| Slow Playback | Go on pressing the  button during pause. |
| Slow Rewind | Go on pressing the  button during pause. |
| Next Frame | Press the  button during pause. |
| Previous Frame | Press the  button during pause. |



Term

Movie Frames

A movie frame is also called a frame. Movies consist of many frames whose images appear to be moving when displayed at high speed.

Other Functions Available in Playback Mode

Playback Setting Menu

The Playback menu provides the functions shown in the table below:

| Setting | Option | Refer to |
|--------------|---|----------|
| SLIDE SHOW | _____ | P.78 |
| PROTECT | Select/Deselect 1 FILE, Select/Deselect ALL FILES, Select Multi-files | P.79 |
| DPOF | Select/Deselect 1 FILE, Select/Deselect ALL FILES, Select Multi-files | P.82 |
| RESIZE | 1280, 640 | P.85 |
| COPY TO CARD | _____ | P.86 |



Note

The SETUP menu can be accessed from within the Playback Setting menu. For details, see P.88.

Using the Playback Menu

1. Turn the Mode Selector to (Playback Mode).
2. Press the MENU button.
The Playback menu appears.
3. Press the buttons to select the desired setting.
4. After selecting a setting item, press the OK or button.
Each function screen appears.



Showing Photos in Order Automatically (SLIDE SHOW)

You can show the recorded still images and movies sequentially on the LCD Monitor. This function is called a slide show.

To view a slide show, follow the steps below.

1. Turn the Mode Selector to  (Playback Mode).

The last shot taken is displayed.

2. Press the MENU button.

The Playback menu appears.

3. Make sure that [SLIDE SHOW] is selected, and then press the OK or  button.

The slide show starts and files are played back in order.

If you want to stop the slide show in progress, press any button on the camera.

Until stopped, the slide show will repeat itself.



Note

- Still images are displayed for 3 seconds each.
- For movies, not just one frame, but the entire movie you shot is displayed.

Write-protecting Your Images (PROTECT)





You can protect files from being accidentally deleted.



Caution

Protected files cannot be deleted normally. However, they will be deleted completely if you format the memory where the files are stored.

Protecting Files

- 1. Turn the Mode Selector to  (Playback Mode).**
The last shot taken is displayed.
- 2. Press the   buttons to display the file you want to protect.**
- 3. Press the MENU button.**
The Playback Setting menu appears.
- 4. Press the  button to select [PROTECT] and press the OK or  button.**
- 5. Make sure that [1 FILE] is selected, and then press the OK button.**



Protection is applied and the Protect symbol appears in the upper-left corner of the screen.



Protecting All Files

To protect all your files, follow the steps below.

1. Turn the Mode Selector to (Playback Mode).

2. Press the MENU button.

The Playback menu appears.

3. Press the button to select [PROTECT] and press the OK or button.

4. Press the button to select [ALL FILES].

5. Make sure that [SELECT] is selected, and then press the OK button.

Protection is applied and the Protect symbol appears in the upper-left corner of the screen.

To remove protection from all your files, select [CANCEL] in step 5.



Note

You can remove protection from all or multiple files at once.

Protecting Multiple Files at Once

To protect selected files all at once, follow the steps below.

1. Turn the Mode Selector to  (Playback Mode).

2. Press the  (Thumbnail Display) button.



The screen is split into six sections and thumbnail images are displayed in a reduced size.

3. Press the    buttons to select the first file of the selection.

4. Press the MENU button.

The Playback menu appears.

5. Press the  button to select [PROTECT] and press the OK or  button.

6. Press the    buttons to select the next file of the selection, and then press the OK button.

The Protect symbol appears in the upper-right corner of the file.

7. Repeat Step 6 to select all the files you wish to protect.

If you selected a file by mistake, you can deselect by selecting the file and pressing the OK button again.

8. Press the MENU button.

The display indicates that the selected images are being processed; once finished, the display returns to the Thumbnail Display screen.



Note

To remove protection from multiple files, follow the same steps described above to select them and remove protection.



Reference

For details on thumbnail display, see P.36.

Using a Printing Service (DPOF: Dee-Pof)

The still images recorded on an SD Memory Card can be printed out if you take them to a shop that offers a digital camera print service.

To use a print service, it is necessary to make settings required for printing. These settings are called DPOF (Dee-Pof) settings.



The DPOF setting specifies one print per still image.

However, if multiple images are selected for batch setting, you can specify the number of copies to print.

Setting DPOF for the Still Image Displayed

1. Turn the Mode Selector to  (Playback Mode).
2. Display the still image you want to specify.
3. Press the MENU button.

The Playback Setting menu appears.

4. Press the  button to select [DPOF] and press the OK or  button.



5. Make sure that [1 FILE] is selected, and then press the OK button.

Once the DPOF setting is made, the DPOF symbol appears in the upper-left portion of the screen.



Note

Removing the DPOF setting for one photo at a time is done in the same way as setting it.



Setting DPOF for All Still Images



To apply DPOF settings to all your still images, follow the steps below.

1. Turn the Mode Selector to  (Playback Mode).

2. Press the MENU button.

The Playback menu appears.

3. Press the  button to select [DPOF] and press the OK or  button.

4. Press the   buttons to select [ALL FILES].

5. Make sure that [SELECT] is selected, and then press the OK button.

Once the DPOF setting is made, the DPOF symbol appears in the upper-left portion of the screen.









Note

- To remove the DPOF setting from all your still images, select [CANCEL] in step 5.
- You can remove all or multiple still image DPOF settings at once.



Setting DPOF for Multiple Still Images

To make the DPOF setting for selected still images all at once, follow the steps below.











1. Turn the Mode Selector to  (Playback Mode).
2. Press the  (Thumbnail Display) button.
The screen is split into six sections with the still images displayed at a reduced size.
3. Press the     buttons to select the first still image for which you wish to make the DPOF setting.

4. Press the MENU button.

The Playback menu appears.

5. Press the  button to select [DPOF] and press the OK or  button.



6. Press the   buttons to set the number of copies to print.
Press the  button to increase the number, or the  button to decrease it.
7. Press the   buttons to select the next still image for which you wish to make the DPOF setting.
8. Press the   buttons to set the number of copies to print.
Press the  button to increase the number, or the  button to decrease it.
9. Repeat Steps 7 and 8 to select all the still images for which you wish to make the DPOF setting.

10. Press the MENU button.

The display indicates that the selected images are being processed; once finished, the display returns to the Thumbnail Display screen.

Changing the Image Size (RESIZE)

You can reduce the image size of a shot still image to additionally create a file of a different image size.



Caution

Only still images can be resized. Movies cannot be resized.



Note

The following types of resizing are possible:

| Original | Resized | |
|-------------------------|---------|------|
| F2304/N2304/F1600/N1600 | N1280 | N640 |
| F1280/N1280 | | N640 |

To change the image size, follow the steps below.

1. Turn the Mode Selector to (Playback Mode).
2. Press the MENU button.
The Playback Setting menu appears.
3. Press the button to select [RESIZE] and press the OK or button.
4. Press the buttons to select [1280] or [640].
5. Press the OK button.

The image size is changed and the resized still image is displayed.



Reference

For how to change the image size at shooting, see P.57.

Copying the Contents of Internal Memory to a Memory Card (COPY TO CARD)

You can copy all movies, still images, and sound data stored in internal memory onto an SD Memory Card at once.

1. Turn the Camera Off.
2. Insert an SD Memory Card.
3. Turn the camera on.
4. Turn the Mode Selector to  (Playback Mode).
5. Press the MENU button.

The Playback Setting menu appears.

6. Press the  button to select [COPY TO CARD] and press the OK or  button.

The display indicates copying is in progress; once finished, the display returns to the playback screen.



Note

- If the capacity of the SD Memory Card you are copying to is insufficient, a message will be displayed indicating there is not enough capacity. To copy only the number of shots that will fit into the available capacity, select [YES] and then press the OK button. To cancel copying, select [NO] and then press the OK button.
- It is not possible to copy from SD Memory Card to internal memory.

Chapter 3

Changing Camera Settings

Changing Camera Settings 88



Changing Camera Settings

SETUP Menu

You can change camera settings by displaying the SETUP menu from the Shooting Setting menu (see P.50) or Playback Setting menu (see P.77).

The SETUP menu enables you to set the items listed in the table below.



| Setting | Option | Refer to |
|------------------------|--|----------|
| FORMAT [CARD] | _____ | P.90 |
| INITIALIZE [INT. MEM.] | _____ | P.91 |
| LCD BRIGHTNESS | _____ | P.92 |
| ADJ. BUTT. SET. | [OFF], PIC QUALITY (), AF/ MF, SHARP, PHOTOMETRY () | P.93 |
| BEEP SOUND | [ON], OFF | P.94 |
| LCD CONFIRM. | OFF, [1], 2, 3 Seconds | P.95 |
| AUTO POWER OFF | OFF, [1], 5, 30 Minutes | P.96 |
| SEQUENTIAL NO. | ON, [OFF] | P.97 |
| POWER SAVE | ON, [OFF] | P.98 |
| DATE SETTINGS | _____ | P.100 |
| LANGUAGE | [日本語], ENGLISH, DEUTSCH, FRANÇAIS, ITALIANO, ESPAÑOL, 简体中文, 繁体中文, 한국어 | P.101 |
| VIDEO OUT MODE | [NTSC], PAL | P.102 |
| SHTG STGS WARNG. | [ON], OFF | P.103 |

Using the SETUP Menu

To display and use the Setup menu, follow the steps below.

Note

For some functions, the choice selection method may not be as explained here. For detailed operation, see the explanation of each function.

1. Press the MENU button.

The Shooting Setting menu (or the Playback menu) appears.

2. Press the ► button.

The setup menu appears.

3. Press the ▲▼ buttons to select the desired setting.

The setting items are provided on three screens.

When the ▼ button is pressed at the bottom item, the next screen appears.



To select a screen by screen number:

1. Press the ◀ button to select a screen number on the left of the screen.
2. With the screen number selectable, press the ▲▼ buttons to switch between screens.
3. After selecting the screen, press the ► button to return to the setting item selection step.

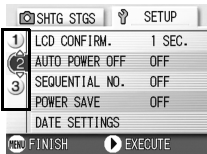

4. After selecting a setting item, press the OK or ► button.

Choices for the setting item are displayed.

5. Press the ▲▼ buttons to select a choice.

6. Press the OK or ◀ button.

7. If you pressed the ◀ button in step 6, press also the MENU button.

The menu disappears and the camera becomes ready for shooting and playing back.

Getting the SD Memory Card Ready for Use (FORMAT [CARD])

If the error message "This card cannot be used" is displayed, or if you have formatted a card with a computer or some other device, it will be necessary to format the SD Memory Card prior to use. Formatting is the process of preparing a card so image data can be written on it.



Caution

If you format a card that still has images stored on it, the images will be lost.



Reference

For how to format internal memory, see P.91.

To format a card, follow the steps below.

1. Display the setup menu.

For detailed operation, see P.89.

2. Press the ▼ button to select [FORMAT [CARD]] and press the OK or ► button.

A screen appears to confirm formatting.

3. Press the ◀ button to select [YES] and then press the OK button.

Formatting starts. When it is done, the display returns to the SETUP menu.

If no SD Memory Card is inserted, a message will be displayed.

After turning the power off, load an SD Memory Card and repeat the formatting process again.



Note

Protecting your images from being deleted

If you move the card's write-protection switch to LOCK, your still images cannot be accidentally erased and the card cannot be formatted.

If you release the protection (by returning the switch to its original position), it is once again possible to erase images and format the card.

Formatting Internal Memory (FORMAT [INT. MEM.])

If an error message "Format the internal memory" is displayed, it will be necessary to format the internal memory prior to use.



Caution

Formatting the internal memory erases all of the images recorded in the memory. If you have images that you do not want to erase stored on the internal memory, please contact the Ricoh Service offices prior to formatting it.

To format internal memory, follow the steps below.

1. Display the setup menu.

For detailed operation, see P.89.

2. Press the ▼ button to select [INITIALIZE [INT. MEM.]] and then press the OK or ► button.

A screen appears to confirm formatting.

3. Press the ◀▶ buttons to select [YES] and then press the OK button.

Formatting starts. When it is done, the display returns to the SETUP menu.

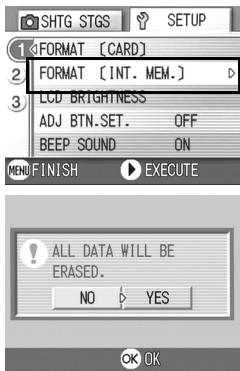

Adjusting the Brightness of the LCD Monitor (LCD BRIGHTNESS)

To adjust the brightness of the LCD Monitor, follow the steps below.

1. Display the setup menu.

For detailed operation, see P.89.

2. Press the ▼ button to select [LCD BRIGHTNESS] and press the OK or ► button.

The LCD Brightness Adjustment bar appears.

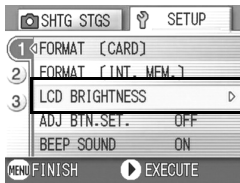

3. Press the ▲▼ buttons to adjust the brightness.

Moving it to the ☀ side makes it darker.

Moving it to the ☁ side makes it brighter.

The brightness of the screen behind the bar changes as you alter the setting.



4. When you attain the desired brightness, press the OK button.

The display returns to the SETUP screen.

This setting will be used until you change it.

Setting a Function to the ADJ. Button (ADJ BTN.SET.)

Each time the ADJ. button is pressed, the camera displays the setting screen in the order of exposure, white balance, and ISO sensitivity.

By using the [ADJ BTN.SET.] option, you can set a function to be activated when the ADJ. button is pressed the fourth time.

| Possible Settings | (Refer to) |
|-----------------------|------------|
| OFF (Set at purchase) | |
| QUALITY (PIC/QUALITY) | P.57 |
| AF/MF (FOCUS) | P.59 |
| SHARP (SHARPNESS) | P.62 |
| PHOTOMETRY | P.63 |

To assign a function to the ADJ. button, follow the steps below.

1. Display the setup menu.

For detailed operation, see P.89.

2. Press the ▼ button to select [ADJ BTN.SET.] and press the OK or ► button.

3. Press the ▲▼ buttons to select the desired setting.

4. Press the OK or ◀ button.

5. If you pressed the ◀ button in step 4, press also the MENU button.

This setting will be used until you change it.



Note

If a function is set with [ADJ BTN.SET], the AF target shift function (P.61) available from the ADJ. button at Macro shooting is activated when the ADJ. button is pressed the fifth time.



Reference

For how to use the ADJ. button, see P.49.

Changing the Beep Sound Setting (BEEP SOUND)

When a shot image is recorded in the internal memory or an SD memory card, the camera will issue a short beep to indicate a picture has been taken. You can mute the beep sound

| Possible Settings |
|---|
| ON (all sounds on) *Initial setting at purchase |
| OFF (all sounds off) |

To change the setting of operation sound, follow the steps below.

1. Display the setup menu.

For detailed operation, see P.89.

2. Press the ▲▼ button to select [BEEP SOUND] and press the OK or ► button.

3. Press the ▲▼ buttons to select the desired setting.

4. Press the OK or ◀ button.

5. If you pressed the ◀ button in step 4, press also the MENU button.

This setting will be used until you change it.

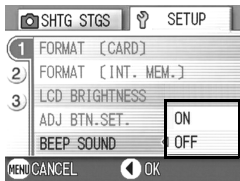

Changing Image Confirmation Time (LCD CONFIRM.)

Immediately after pressing the shutter button, the still image taken is displayed for a moment so you can check it.

At purchase, Confirmation Time is set to one second, but this can be changed.

| Possible Settings |
|--|
| OFF (Photo not displayed for confirmation) |
| 1 Second (Default) |
| 2 Seconds |
| 3 Seconds |

To change Confirmation Time, follow the steps below.

1. Display the setup menu.

For detailed operation, see P.89.

2. Press the ▲▼ button to select [LCD CONFIRM.] and press the OK or ► button.

3. Press the ▲▼ buttons to select the desired setting.

4. Press the OK or ◀ button.

5. If you pressed the ◀ button in step 4, press also the MENU button.

This setting will be used until you change it.

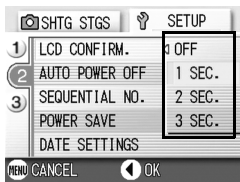

Changing Auto Power-Off Settings (AUTO POWER OFF)

If you do not operate the camera for the set period of time, it will shut off automatically (Auto Power-off) to conserve battery power.

At the time of purchase, Auto Power-Off is set to one minute, but you can change this setting.

| Possible Settings |
|---|
| OFF (The Auto Power-Off function does not work) |
| 1 Minute (Default) |
| 5 Minutes |
| 30 Minutes |

To change the Auto Power-Off setting, follow the steps below.

1. Display the setup menu.

For detailed operation, see P.89.

2. Press the ▼ button to select [AUTO POWER OFF] and press the OK or ► button.

3. Press the ▲▼ buttons to select the desired setting.

4. Press the OK or ◀ button.

5. If you pressed the ◀ button in step 4, press the MENU button.

This setting will be used until you change it.

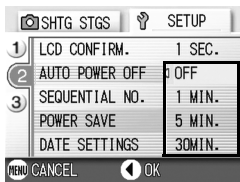

Note

- To continue on using the camera after auto power-off, slide the power switch to close the lens cover once (power-off) and slide it again to open (power-on). When the Playback button is pressed, the lens cover does not open but the camera is turned on for use in Playback Mode.
- The Auto Power-off function does not work when the camera is connected to a computer.
- When shooting with Interval Shooting, settings made here are not valid and Auto Power-Off does not work.

Changing File Name Settings (SEQUENTIAL NO.)

When you shoot a still image, it is stored on an SD Memory Card or in internal memory, with a consecutively numbered file name automatically assigned. When you are switching SD Memory Cards, you can set your camera to continue consecutive numbering from the previously loaded SD Memory Card.

| Possible Settings | |
|---|---|
| ON (Continue numbering) | File names will be automatically assigned to still images you take, in the format of "R" followed by 7 digits, from R0010001.jpg to R9999999.jpg. With this setting, even when one SD Memory Card is switched with another, consecutive file numbering from the previous card is continued. |
| OFF (Do not continue numbering) (Default) | Every time a new card is loaded, file numbering is assigned, from RIMG0001.jpg to RIMG9999.jpg. If numbering exceeds RIMG9999, further recording is not possible. |

To make changes to file numbering, follow the steps below.

1. Display the setup menu.

For detailed operation, see P.89.

2. Press the ▼ button to select [SEQUENTIAL NO.] and press the OK or ► button.

3. Press the ▲▼ buttons to select the desired setting.

4. Press the OK or ◀ button.

5. If you pressed the ◀ button in step 4, press also the MENU button.

This setting will be used until you change it.

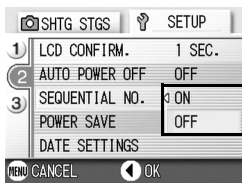

Note



- When you are recording to internal memory, file names are assigned just as when [SEQUENTIAL NO.] is set to [OFF].
- When transferring images to a computer, if a file already exists with the same name in the destination folder, your image is renamed before saving to avoid overwrite problem.
- When transferring images to a computer via the provided USB cable, the files are assigned names like RIMG****.jpg (**** indicates the number of the image), even if [SEQUENTIAL NO] is set to ON.

Changing Power-Save Mode Settings (POWER-SAVE)

The display on the LCD Monitor will turn off.

Press the MENU or ADJ. button to turn the LCD Monitor display on, and then press it again to turn the display off. After the end of setting, the display returns to off.

If you press the  button, The still image you just took is displayed on the LCD Monitor.

You cannot turn the LCD Monitor Display on/ off by pressing the  (Self-timer) or  (Macro) button.

| Possible Settings |
|---|
| OFF (Power-Save Mode Inactivated) (Set at purchase) |
| ON (Activate Power-Save Mode) |

To change the Power-Save Mode, follow the steps below.

1. Display the setup menu.

For detailed operation, see P.89.

2. Press the button to select [POWER SAVE] and press the OK or button.

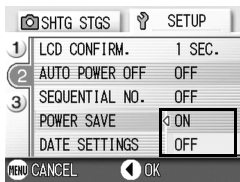

3. Press the buttons to select the desired setting.

4. Press the OK or button.

5. When you selected [ON], a message appears for confirmation. Press the buttons to select [YES], and then press the OK button.

6. Press the MENU button.

This setting will be used until you change it.



Note

- Once the power is turned off or change the mode, the Quick Review function can no longer recall the most recently taken image.
- When the Power-Save mode is set to ON, if the power is turned on or the mode dial is turned to another position, a warning appears for about two seconds to indicate Power-Save mode.
- Pressing the  (Flash) button allows you to turn the LCD Monitor Display on, and then change the flash setting (see P.32). Press the shutter button or OK button to turn the LCD Monitor Display off.



Caution

If you have activated Power-Save mode, power consumption will be reduced, but there are the following limitations:

- Processing time may be slower.
- It works only in Still Image/Movie modes. It does not work in Playback Mode.

Setting the Date and Time (DATE SETTINGS)

You can take still images with the time or date stamped onto the picture.

The date/time setting on the SETUP menu is explained here.

1. Display the setup menu.

For detailed operation, see P.89.

2. Press the ▼ button to select [DATE SETTINGS] and press the OK or ► button.

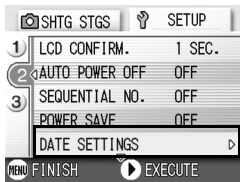

3. Press ▲▼◀▶ to set the year, month, date and time.

If you hold down the ▲ or ▼ button, you can increase/decrease the value quickly.

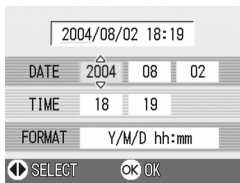

4. In [FORMAT], choose the date and time format.

5. Check the display on the bottom of the screen and then press the OK button.

Once you have set the date and time, the display returns to the Setup menu.

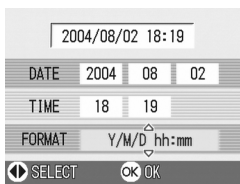

Note

If the batteries are removed for more than one week, the date and time settings will be lost. These settings must be made again.

Changing the Display Language (LANGUAGE)

You can change the language displayed on the LCD Monitor.

| Possible Settings |
|-----------------------------|
| 日本語 (Japanese) |
| ENGLISH (English) (Default) |
| DEUTSCH (German) |
| FRANÇAIS (French) |
| ITALIANO (Italian) |
| ESPAÑOL (Spanish) |
| 簡体中文 (Simplified Chinese) |
| 繁体中文 (Traditional Chinese) |
| 한국어 (Korean) |

To change the display language, follow the steps below.

1. Display the setup menu.

For detailed operation, see P.89.

2. Press the ▼ button to select [LANGUAGE] and press the OK or ► button.

The language selection screen appears.

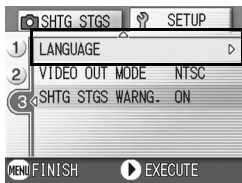

3. Press the ▲▼◀▶ buttons to select the desired setting.

4. Press the OK button.

This setting will be used until you change it.



Changing the Playback Method for Viewing on TV (VIDEO OUT MODE)

You can view your still images and movies on a television screen by connecting your camera to a television with the VIDEO cable that came with your camera.

Your camera is set to NTSC video format (used in Japan and other countries) for use with television equipment, etc. If the equipment you want to connect to uses PAL format (used in Europe and elsewhere), then switch your camera to PAL format before connecting.

| Possible Settings |
|-------------------|
| NTSC (Default) |
| PAL |

To change the playback format, follow the steps below.

1. Display the setup menu.

For detailed operation, see P.89.

2. Press the **▼** button to select [VIDEO OUT MODE] and press the OK or **▶** button.

3. Press the **▲▼** buttons to select the desired setting.

4. Press the OK or **◀** button.

5. If you pressed the **◀** button in step 4, press also the MENU button.

This setting will be used until you change it.



Note

Connecting the VIDEO cable to the camera turns off the LCD monitor display.



Reference

For how to view still images on your television screen, see P.38.

Displaying a Setting Change Warning (SHTG STGS WARNG.)

You can set the icon of a changed function blink or a warning message indicating a change will be displayed at power-on for about 5 seconds if the initial settings are changed for the following functions.

- White Balance
- Focus
- ISO Setting
- Exposure Comp.
- Time Exposure

If you operate a camera button, the icon is changed from blinking to steady.

If you operate a camera button during warning message display, the message disappears.

| Possible Settings |
|-------------------|
| OFF |
| OFF (Default) |

To set whether to enable (ON) or disable (OFF) the shooting setting alert, follow the steps below.

1. Display the setup menu.

For detailed operation, see P.89.

2. Press the ▼ button to select [SHTG STGS WARNG.] and press the OK or ► button.

3. Press the ▲▼ buttons to select the desired setting.

4. Press the OK or ◀ button.

5. If you pressed the ◀ button in step 4, press also the MENU button.

This setting will be used until you change it.



Chapter 4

Installing Software

| | |
|--|-----|
| Installing the Provided Software (For Windows) | 106 |
| Installing the Provided Software (For Macintosh) | 118 |

Installing the Provided Software (For Windows)

You need to install software for transferring images to your computer before you can download images from the camera.

Reference

For how to download images from the camera into your computer, see the Software User Guide available from the Caplio Software CD-ROM. For how to display the Software User Guide, see P.107.

Caution

Be sure to install the software before you connect the camera to your computer with the cable.



Software that can be installed from the Caplio Software CD-ROM

Once you insert the Caplio Software CD-ROM in the CD-ROM drive, the following screen appears automatically:

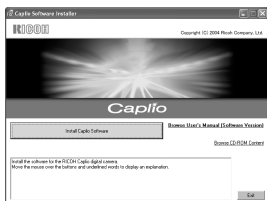

| Item Name | Description | (Refer to) |
|--------------------------|--|------------|
| Install Caplio Software | Use this button to install software required for handling the camera and images. | P.109 |
| View Software User Guide | Use this button to display the Software User Guide (PDF). | P.107 |
| Browse CD-ROM | Use this button to display the list of files contained on the CD-ROM. | P.107 |

When [Install CaplioSoftware] is clicked: (P.109)

The following software will be installed:

| Software | Windows | | Description |
|----------------|-----------------------|-----------------------|---|
| | XP | 98 | |
| RICOH Gate La | <input type="radio"/> | <input type="radio"/> | Downloads images. |
| CaplioViewer | <input type="radio"/> | <input type="radio"/> | Allows images to be displayed, edited, or corrected. DirectX (see P.116) is required to play back movies. |
| USB Driver | <input type="radio"/> | <input type="radio"/> | Connects the camera to your computer. |
| WIA Driver | <input type="radio"/> | | Downloads images. |
| Mounter | | | Connects the camera to your computer. |
| List Editor | <input type="radio"/> | <input type="radio"/> | Not used by this model but used by other models of Caplio camera. |
| Caplio Setting | <input type="radio"/> | <input type="radio"/> | |
| Caplio Server | <input type="radio"/> | <input type="radio"/> | |

XP:Windows XP

98:Windows 98/98SE/Me/2000

When [View Software User Guide] is clicked:

The Software User Guide (PDF file) on the Caplio Software CD-ROM can be displayed on your computer screen. If you are a Windows user and has Acrobat Reader installed on your computer, simply double-click [View Software User Guide].

If not installed, Acrobat Reader should be installed (see P.115).

Click [Browse CD-ROM].

List of files on the CD-ROM can be displayed on your computer screen.

| Software | Description | Refer to |
|----------------|---|----------|
| Acrobat Reader | Required for viewing the Software User Guide. | P.115 |
| DirectX | Required for playing back movies. | P.116 |

System Requirements for Using the Provided Software

The following environments are necessary for using the provided software. Please check your computer, or the computer's user manual.

| | |
|--|--|
| Operating Systems Supported | Windows 98/98 Second Edition |
| | Windows 2000 Professional |
| | Windows Me |
| | Windows XP Home Edition/Professional |
| CPU | Pentium 2 or higher |
| Memory | Windows 98/98SE: 32MB or more (96MB or more recommended) |
| | Windows 2000: 128MB or more (256MB or more recommended) |
| | Windows Me: 64MB or more (96MB or more recommended) |
| | Windows XP: 128MB or more (256MB or more recommended) |
| Hard drive space required for installation | Windows 98/98SE: 10MB or more |
| | Windows 2000: 10MB or more |
| | Windows Me: 10MB or more |
| | Windows XP: 10MB or more |
| Display resolution | 640 x 480 pixels or greater (800 x 600 or greater recommended) |
| Display colors | 256 colors or greater (65000 or greater recommended) |
| CD-ROM drive | A CD-ROM drive compatible with the above-mentioned computer body |
| USB port | A USB port compatible with the above-mentioned computer body |



Caution

- If your computer has an upgraded OS, the USB function may not work normally, so it cannot be supported.
- Problems may arise due to changes made to the OS, such as through patches or a service package release.
- Connection to a USB port retrofitted using an extended function (PCI bus, etc.) cannot be supported.
- If used in conjunction with a hub or other USB devices, the software may not work properly.
- When dealing with movies and other large files, a larger memory environment is recommended.



Reference

For how to download images to your computer using an SD Memory Card, see the Software User Guide.

Installing the Software on Your Computer (Windows XP)



Caution

- Do not connect your camera to the computer until indicated. If you happened to connect your camera to the computer (resulting in the [Add New Hardware Wizard] screen appearing), simply click [Cancel], and after disconnecting your camera, install the software on your computer.
- For Windows XP, Administrator privileges are required to install this software.

1. Start your computer and insert the Caplio CD-ROM in the CD-ROM drive.

The screen shown on the right appears automatically.



2. Click [Install CaplioSoftware].

After a while, the [Select Setting Language] screen appears.

3. Confirm the language, and then click [OK].

After a few moments, the [Welcome to InstallShield Wizard] screen appears.

4. Click [Next].

After a few moments, the [Select Installation Destination] screen appears.

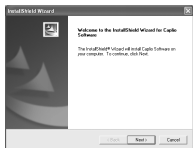

5. Confirm where you want to install and then click [Next].

The [Select Program Folder] screen appears.



6. Confirm where you want to install and click [Next].

[InstallShield Wizard Complete] screen appears.

7. Click [Finish].

The message shown on the right appears.



The next step is to connect the camera to your computer and set up the drivers. See P.113 and the following pages.



Note

After installation, it may be necessary to restart your computer.



Reference

For how to remove (uninstall) the software, see P.117.

Installing the Software on Your Computer (Windows 98/98SE/Me/2000)



Caution

- Do not connect your camera to the computer until indicated. If you happened to connect your camera to the computer (resulting in the [Add New Hardware Wizard] screen appearing), simply click [Cancel], and after disconnecting your camera, install the software on your computer.
- For Windows 2000, Administrator privileges are required to install this software.

1. Start your computer and insert the Caplio CD-ROM in the CD-ROM drive.

The screen shown on the right appears automatically.



2. Click [Install CaplioSoftware].

3. Confirm the language, and then click [OK].

4. Click [Next].

5. Confirm where you want to install and then click [Next].

The [Select Program Folder] screen appears.



6. Confirm where you want to install and click [Next].

[InstallShield Wizard Complete] screen appears.

7. Click [Finish].



Note

After installation, it may be necessary to restart your computer.



Reference

For how to remove (uninstall) the software, see P.117.

Connecting the Camera to Your Computer

After installing the software on your computer, connect your camera to it.

1. Make sure the camera power is off.
2. Connect the USB cable to the USB port of your computer.

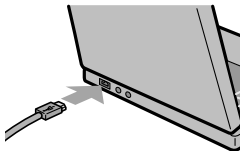

3. Connect the USB cable to the USB terminal of your camera.
Your camera turns on.

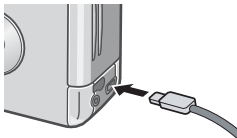

For Windows XP

The first time you connect your camera to the computer using a USB cable, the [Found New Hardware Wizard] screen will appear.

1. Select [Install from a list or specific location (Advanced)].
2. Select [Next].
3. Select [Search for the best driver in these locations.] -[Include this location in the search] and then press the [Browse] button.

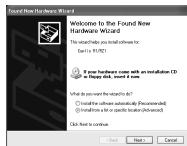

4. Browse to the folder where the WIA driver was installed (by default this should be C:\Program Files\CaplioSoftware\WIA driver) and then select [Next].

The WIA Driver is installed.

The [Caplio R1/RZ1] screen appears.

5. Select [RICOH Gate La], check [Always use this program for this action] check box, and then click [OK].

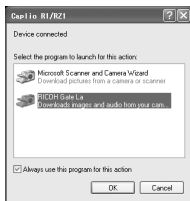

To load images from the camera with assistance from the Windows XP Scanner and Camera Wizard, select [Scanner and Camera Wizard].

Leaving the [Always use this program for this action] check box unchecked will cause the [Caplio R1/RZ1] screen to be displayed each time you transfer images from the camera, thereby allowing you to choose whether to use RICOH Gate La or the Scanner and Camera Wizard for image transfers.

Disconnecting the Camera from Your Computer:

1. Turn your camera off by pressing the power button.
2. Unplug the USB cable.



Note

It is recommended that you use the AC Adapter (sold separately) when you are downloading images from your camera.

Installing Other Software

For Windows, in addition to the Caplio Software, you can also install the following software from the CD-ROM provided.

- Acrobat Reader
- DirectX

Do not install the software when the camera is connected to your computer with a USB cable.

Installing Acrobat Reader

Acrobat Reader is required to display the operation manual (PDF file).

If the computer is running under Windows, Acrobat Reader can be installed.

Acrobat Reader need not be installed if already installed on your computer.

For Windows XP or Windows 2000, Administrator privileges are required to install the software.

1. Start your computer, and insert the included Caplio Software CD-ROM into the CD-ROM drive.

The following screen appears automatically.

2. Click [Browse CD-ROM].

The files on the CD-ROM are listed.

3. Double-click the [Acrobat] folder.

4. Double-click the [English] folder.

5. Double-click [ar500enu] (ar500enu.exe).

6. Install Acrobat Reader by following the messages displayed.

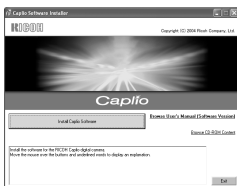

Installing DirectX

DirectX is software to play back movies.

This camera requires DirectX 7.1 or later to play movie files in Windows. If you have an earlier version installed, please install the updated version available on the accompanying CD-ROM.

For Windows XP, installation of DirectX is not needed because the updated version is already installed.

For Windows 2000, Administrator privileges are required to install the software.

- 1. Start your computer, and insert the included Caplio Software CD-ROM into the CD-ROM drive.**
- 2. Click [Browse CD-ROM].**
- 3. Double-click the [DirectX] folder.**
- 4. Double-click the [English] folder.**
- 5. Double-click the following file:**

| | |
|-------------------|---|
| Windows98/98SE/Me | [DX81xxx.exe] in the [Win98Me] folder |
| Windows2000 | [DX81NTxxx.exe] in the [Win2000] folder |

Uninstalling the Software

For Windows 2000/XP, Administrator privileges are required to uninstall the software.

1. Click **[Start]** on the Windows task bar.
2. Select **[Settings]** and then **[Control Panel]**.
3. Double-click the **[Add/Remove Programs]** icon (or the **[Add Or Remove Programs]** icon in Windows XP).
4. Select **[Caplio Software]** and then click **[Change/Remove]**.
5. Confirm file deletion and click **[OK]**.
6. Select the **[Don't display this message again.]** check box, and then click **[OK]**.

The [Shared File Detected] dialog box appears.

The uninstallation process begins. When it is finished, close the displayed window.

Installing the Provided Software (For Macintosh)

You need to install software for transferring images to your computer before you can download images from the camera.



Reference

For how to download images from the camera into your computer, see the Software User Guide available from the Caplio Software CD-ROM. For how to display the Software User Guide, see P.119.



Caution

Be sure to install the software before you connect the camera to your computer with the cable.



Software that can be installed from the Caplio Software CD-ROM

Once you insert the Caplio Software CD-ROM in the CD-ROM drive, the following screen appears automatically:



| Item Name | Description | (Refer to) |
|--------------------------|--|----------------|
| Install Caplio Software | Use this button to install software required for handling the camera and images. | P.121 P.122 |
| View Software User Guide | Use this button to display the Software User Guide (PDF). | P.119 |
| Browse CD-ROM | Use this button to display the list of files contained on the CD-ROM. | |

When [Install CaplioSoftware] is clicked:

The following software will be installed:

| Software | Mac | | Description |
|---------------|-----------------------|-----------------------|---------------------------------------|
| | 9 | X | |
| RICOH Gate La | <input type="radio"/> | | Downloads images. |
| USB Driver | <input type="radio"/> | <input type="radio"/> | Connects the camera to your computer. |
| Mounter | <input type="radio"/> | <input type="radio"/> | Connects the camera to your computer. |

9: Mac OS 8.6 to Mac OS 9.2.2

X: Mac OS X 10.1.2 to 10.3

When [View Software User Guide] is clicked:

The Software User Guide (PDF file) on the Caplio Software CD-ROM can be displayed on your computer screen.

If not installed, Acrobat Reader should be installed.

System Requirements for Using the Provided Software

The following environments are necessary for using the provided software.

Please check your computer, or the computer's user manual.

| | | |
|---|--|---|
| Operating System | Mac OS 8.6 to 9.2.2 / Mac OS X 10.1.2 to 10.3 | |
| Macintosh | A USB port standard-equipped Apple Macintosh Series | |
| Internal Memory | Mac OS 8.6 to 9.2.2 | 96 MB or more (128 MB or more recommended) |
| | Mac OS X 10.1.2 to 10.3 | 128 MB or more (256 MB or more recommended) |
| Application Allocated Memory (For Mac OS 8.6 to 9.2.2) | Without using the compression utility, 16MB or more (24 MB or more is recommended) as Application Memory | |
| Hard Disc Drive Capacity | Mac OS 8.6 to 9.2.2 | 10 MB or more (at installation) |
| | Mac OS X 10.1.2 to 10.3 | 100 MB or more (at installation) |
| | 100 MB or more (at operation) | |
| Display resolution | 640 x 480 pixels or greater (800 x 600 or greater recommended) | |
| Display colors | 256 colors or greater (32000 or greater recommended) | |
| CD-ROM drive | A CD-ROM drive compatible with the above-mentioned Macintosh machine | |
| USB port | A USB port compatible with the above-mentioned computer body | |



Caution

- Problems may arise due to changes made to the OS environment setting.
- Connection to a USB port retrofitted using an extended function (PCI bus, etc.) cannot be supported.
- If used in conjunction with a hub or other USB devices, the software may not work properly.



Note

- When dealing with movies and other large files, a larger memory environment is recommended.
- For Mac OS 8.6 to 9.2.2, use a larger memory environment, as well as allocating extra application memory.
- While the software can be operated at 256 colors or more for the Display Color, it is strongly recommended that 32,000 or more be used.



Reference

For how to download images to your computer using an SD Memory Card, see the Software User Guide.

Installing the Software on Your Computer (Mac OS 8.6 to 9.2.2)

1. Turn on your Macintosh and insert the Caplio Software CD-ROM in the CD-ROM drive.
2. Select the OS 9 folder.
The [Caplio Installer] icon appears.
3. Double-click [Caplio Installer].
The "Caplio Installer" window opens.



Caplio Installer

4. Click [Install CaplioSoftware].
5. Click [OK].
6. Click [Install].
When installation finishes, a message appears to inform you that it is necessary to restart your Macintosh.
7. Click [Continue].



The software is installed and after a while the Installation Complete message appears.

8. Click [Restart].
Your Macintosh restarts.



Note

To remove (uninstall) the software:

To remove (uninstall) the software from your Macintosh, drag and drop the installed file into the Trash.

| File Name | Folder Name |
|----------------------|-------------------------------|
| RICOH Gate La | System Folder: Control Panels |
| RICOH Gate La Prefs | System Folder: Preferences |
| Caplio Mounter | System Folder: Extensions |
| Caplio Mounter Prefs | System Folder: Preferences |
| Caplio USB Driver | System Folder: Extensions |

Installing the Software on Your Computer (Mac OS X 10.1.2 to 10.3)

1. Turn on your Macintosh and insert the Caplio CD-ROM in the CD-ROM drive.

2. Open the Mac OS X folder.

The [Caplio Mounter.pkg] icon appears.

3. Double-click [Caplio Mounter.pkg].

The Installer starts. A screen appears prompting you to enter the administrator's password.

4. Click the key icon.

An authentication window appears.

5. Enter the administrator's name and password, and then click [OK].

6. Click [Continue].

The [Select a Destination] screen appears.



7. Click the destination volume you want, and then click [Continue].



8. Click [Install].

When installation finishes, a message appears to inform you that it is necessary to restart your Macintosh.

9. Click [Continue Installation].

The software is installed, and after a while an Installation Complete message appears.



10. Click [Restart].

Your Macintosh restarts.



Note

To remove (uninstall) the software:

1. Start [Caplio Mounter] in [Applications] folder.
2. Select [Uninstall] in [File] menu.
The uninstallation process begins.

Chapter 5

Troubleshooting

| | |
|----------------------|-----|
| Troubleshooting..... | 126 |
| Appendices..... | 131 |

Troubleshooting







Troubleshooting the Camera

Power Supply

| Symptom | Cause | Remedy | Refer to |
|--------------------------------|---|---|------------------------|
| The power does not come on. | Batteries are not loaded. Or they are exhausted. | Load the batteries correctly. Recharge or use the AC Adapter. | P.20 P.133 P.134 |
| | The AC Adapter is not connected correctly. | Reconnect it properly. | P.134 |
| | Because the camera overheated the power was automatically turned off. | Wait until the temperature of the camera returns to normal. Do not attempt to cool the camera suddenly. | P.21 |
| | The camre is automatically turned off by Auto Power-off. | Turn the power on again. | P.21 |
| The power cuts out during use. | The camera was left unattended and unused, so Auto Power-Off shut it off. | Turn the power on again. | P.21 |
| | Batteries are running low. | If using alkaline batteries, replace the batteries with a new set. If using rechargeable batteries, recharge or use the AC Adapter. | P.16 |
| The power does not go off. | Camera malfunction. | Remove batteries once and load them again. Reconnect the AC adapter cable properly, if using. | P.20 P.133 P.134 |
| Cannot recharge the batteries. | Battery life. | Replace the batteries with a new set. | P.16 |
| Batteries run out quickly. | They are being used in extreme high or low temperatures. | - | - |
| | Many shots are being taken in dark places inside, requiring flash. | - | - |

Shooting

| Symptom | Cause | Remedy | Refer to |
|---|--|---|------------------------|
| The camera does not shoot even if you press the shutter release button. | Batteries are not loaded. Or they are exhausted. | If using alkaline batteries, replace the batteries with a new set. If using rechargeable batteries, recharge or use the AC Adapter. | P.16 P.133 P.134 |
| | The power is not on. The camera is not in Still Image, Movie, or Sound (Voice Memo) Mode. | Turn the power on and turn the Mode Dial to Shooting Mode. | P.21 |
| | The camera is in Playback Mode. | Set the model selector to a shooting mode (Still Image Mode, Movie Mode, or Voice Mode) and press the Playback button. | P.26 |
| | The shutter button is not pressed all the way. | Press the shutter button all the way. | P.26 |
| | The Memory Card is not formatted. | Format the card. | P.90 |
| | The Memory Card does not have any free space. | Load a new card, or delete unwanted files. | P.20 P.40 |
| | End of Memory Card life. | Load a new memory card. | P.20 |
| | The flash is recharging. | Wait until the flash lamp stops blinking. | P.32 |
| | The SD Memory Card is "locked". | Release the "Lock (write-protection)". | P.19 |
| | The SD Memory Card's contact surfaces are dirty. | Wipe off with a soft, dry cloth. | - |
| Failed to confirm the shot image. | The image confirmation time is too short. | Lengthen the image confirmation time. | P.95 |
| Images do not appear on the LCD Monitor. | The power is not on. Or the LCD Monitor is dark. | Turn the power on. Or adjust the brightness of the LCD Monitor. | P.21 P.92 |
| | The VIDEO/AV cable is connected. | Disconnect the VIDEO/AV cable. | P.38 |
| | The screen display status is in [SYNCHRO-MONITOR MODE]. | Press the DISP. button and switch display. | P.24 |
| | It is set to [Power-Save]. | Set [Power-Save] to off. | P.98 |
| Although it is set to Auto Focus, it does not focus. | The lens is dirty. | Wipe clean with a soft, dry cloth. | P.12 |
| | The subject is not in the center of the shooting range. | Shoot with Focus Lock. | P.28 |
| | It is a hard-to-focus subject. | Shoot with Focus Lock or Manual Focus. | P.28 P.59 |
| A picture is blurred. | You moved the camera when pressing the shutter release button. | Hold the camera with your elbows tight on your body. Or use a tripod. | P.25 |
| | When shooting in a dark place (ex. indoor), the shutter speed slows down and pictures become easily blurred. | Use the flash. Or, raise the ISO sensitivity. | P.32 P.55 |

| Symptom | Cause | Remedy | Refer to |
|--|--|---|--------------|
| The flash does not fire. Or the flash cannot recharge. | The Shooting Mode is set to  (Multi-Shot) or  (Movie). | Switch the Shooting Mode to  (Still Image). | P.12 |
| | The flash is set to  (Flash Off). | Deselect the Flash Off with the  button. | P.32 |
| | Batteries are running low. | If using alkaline batteries, replace the batteries with a new set. If using rechargeable batteries, recharge or use the AC Adapter. | P.16 |
| Even though the flash fired, the picture is dark. | The distance to the subject is greater than 2.0 meters in Telephoto or greater than 3.0 meters in Wide-angle. | Get closer to your subject and shoot. | P.32 |
| | The subject is blackish. | Correct exposure. (Exposure correction also changes the light quantity of the flash.) | P.52 |
| The image is too bright. | The light quantity of the flash is not appropriate. | Move a little away from the subject or light up the subject for shooting without flashing. | P.32 |
| | It is over-exposed. | Use exposure compensation. Cancel Exposure Time. | P.52 P.65 |
| | The brightness of the LCD monitor is not appropriate. | Adjust the brightness of the LCD Monitor. | P.92 |
| The image is too dark. | The shot was taken in a dark place while set to  (Flash Off). | Deselect the Flash Off with the  button. | P.32 |
| | It is under-exposed. | Use exposure compensation. Set to Exposure Time. | P.52 P.65 |
| | The brightness of the LCD monitor is not appropriate. | Adjust the brightness of the LCD Monitor. | P.92 |
| The image lacks natural color. | The picture was shot in conditions that are hard for Auto White Balance to adjust to. | Add a white object to the composition. Or use a White Balance setting other than Auto. | P.53 |
| The date, or recording information does not appear. | The screen display function is set to No Display. | Press the DISP. button and switch display. | P.24 |
| The brightness of the LCD Monitor changes during AF. | You are using it in a dark place or when Auto Focus range and surrounding brightness are different. | This is normal. | - |
| There is a vertical smear on the image. | This is a phenomenon that occurs when a bright subject is shot. It is called the smear phenomenon. | This is normal. | - |

Playback/Deleting

| Symptom | Cause | Remedy | Refer to |
|--|---|--|--------------|
| Cannot Playback. Or the Playback screen does not come out. | The camera is not in Playback Mode. | Turn the Mode Selector to Playback Mode. | P.34 |
| | The VIDEO/AV cable is not connected properly. | Reconnect it properly. | P.38 |
| | The video format is set wrong. | Set to correct format. | P.102 |
| The contents of SD Memory Card cannot be replayed. Or the Playback screen does not come out. | No memory card is loaded. Or a Memory Card with no stored images is loaded. | Load a card with stored images. | P.20 |
| | You played back a Memory Card that was not formatted by this device. | Load a card that was formatted and stored on by this device. | P.20 P.90 |
| | You played back a Memory Card that was not recorded normally. | Load a normally recorded card. | P.20 |
| | The SD Memory Card's contact surfaces are dirty. | Wipe off with a soft, dry cloth. | - |
| | There is something wrong with the Memory Card. | Play another card and if there is nothing wrong with it, the camera is OK. There may be something wrong with the card, so do not use it. | - |
| An image disappeared. | Batteries are running low. | If using alkaline batteries, replace the batteries with a new set. If using rechargeable batteries, recharge or use the AC Adapter. | P.16 |
| | The camera was left unattended and unused, so Auto Power-Off shut it off. | Turn the power back on. | P.21 |
| Files cannot be deleted. | The file has been set to protect. | Release the protection. | P.79 |
| | The SD Memory Card is "locked". | Release the "Lock (write-protection)". | P.19 |
| Cannot format a Memory Card. | The SD Memory Card is "locked". | Release the "Lock (write-protection)". | P.19 |

Other Problems

| Symptom | Cause | Remedy | Refer to |
|--|--|---|------------------------------------|
| Cannot load the Memory Card. | The card is facing the wrong way. | Load correctly. | P.20 |
| Even when the camera's buttons are pressed, it does not operate. | Batteries are running low. | If using alkaline batteries, replace the batteries with a new set. If using rechargeable batteries, recharge or use the AC Adapter. | P.16 P.133 P.134 |
| | Camera malfunction. | Turn the power back on. Remove batteries once and load them again. Reconnect the AC adapter cable properly, if using. | P.21 P.20 P.133 P.134 |
| The date is wrong. | The correct date/time are not set. | Set the correct date/time. | P.100 |
| The date set has disappeared. | The batteries were removed. | If the batteries are removed for about one weeks, the date setting will be lost. Make the settings again. | P.100 |
| Auto Power-Off does not work. | Auto Power-Off is set to OFF. | Set the time for Auto Power-Off. | P.96 |
| The beep does not sound. | The camera is set to silent. | Set the beep to ON. | P.94 |
| Images do not appear on the TV. | The video format is set wrong. | Set to correct format. | P.102 |
| | The cable is not connected. | Reconnect the cable properly. | P.38 |
| | The TV in/out switch is incorrectly set. | Check that the TV in/out switch is set correctly. | - |

Appendices

A. Specifications

General

| | |
|-----------------------------|--|
| Video Signal Format | NTSC, PAL |
| Power Source Voltage | AA Dry Alkaline Batteries (1.5 V) x 2 Rechargeable Battery (3.7 V) x 1 External Part (AC Adapter); 3.8 V |
| External Dimensions Weight | 102.4mm (W) x 56.7mm (H) x 25.1mm (D) (excluding projecting parts) |
| Weight | Approx. 125g (excluding battery/SD Memory Card/Strap) |
| Operating Temperature Range | 0 °C to 40 °C |
| Operating Humidity Range | 85% or less |
| Storage Temperature Range | -20 °C to 60 °C |

Camera Parts

| | |
|---|--|
| Image Pickup Used | Total 4.19 million pixels (effective pixels 4.00million) |
| Lens | |
| • Lens | 3 x Optical Zoom lens: F2.8 to 5.0 |
| • Focal Length | F: 5.65 to 16.95 mm (35 mm equivalent, 35 to 105 mm) |
| • Shooting range | 0.6m or more (from the front end of the lens barrel) |
| • Macro Shooting Distance | 0.01m or more (Wide-angle), 0.16m or more (Zoom-angle) |
| • Digital Zoom | 3.6 times |
| Monitor Display Parts | |
| • Screen Size | 1.8" |
| • Type | Transparent Amorphous Silicon TFT LCD |
| • Pixel Count | Approx. 85,000 |
| • White Balance | AUTO/Fixed (Daylight, Overcast, Tungsten light, Fluorescent light, One Push) |
| Exposure Adjustment | |
| • Light Metering Sensitive Distribution | Multi Light Metering (256 segments), Center-weighted Light Metering, Spot Metering |
| • Exposure Compensation | Exposure Compensation +/-2.0EV (1/3EV Steps) |
| • Metering Method | TTL-CCD Metering Method |
| • Flash AE | Yes (In Daylight Synchro: On) |

| | |
|------------------------|--|
| • Shutter | Still image: 8, 4, 2, 1 to 1/2000 seconds Movie: 1/30 to 1/2000 seconds |
| • ISO Sensitivity | AUTO, ISO64, ISO100, ISO200, ISO400, ISO800 |
| Distance Control | |
| • AF Method | Normal Shooting: CCD method; Macro: CCD method |
| • AF Measurement Range | Normal: approx. 60 cm - infinity. Macro: approx. 1 cm - infinity |
| Internal Flash | |
| • Method | Flashmatic |
| • Shooting Distance | Approx. 0.17 to 3.0 m (W), Approx. 0.16 to 2.0 m (T) (ISO:AUTO) |
| • Operating Modes | Flash Off/Forced flash/Auto/Slow synchro/Red-eye reduction |
| • Date Maintain Time | Approx. 1 week |

Image Data Record/Replay Part

Pixels

| | |
|----------------|---|
| • Still Images | 2304 X 1728, 1600 X 1200, 1280 X 960, 640 X 480 |
| • Text | 2304 X 1728, 1280 X 960 |
| • Movies | 320 X 240, 160 X 120 |

File Formats

| | |
|----------------|---|
| • Still Images | Compressed; JPEG (Exif Ver.2.21)) |
| • Text | TIFF (MMR Method ITU-T.6) |
| • Movies | AVI (Open DML Motion JPEG Format Compliant) |

Camera File System Standard DCF (DCF is an abbreviation for "Design rule for Camera File system", a JEITA standard)

Compression Format JPEG Baseline Format Compliant (Still, Movie)

Image Size

| | |
|---------------|--|
| • 2304 X 1728 | N; approx. 804 KB/Screen, F; approx. 1.54 MB/ Screen |
| • 1600 X 1200 | N; approx. 495 KB/Screen, F; approx. 964 KB/ Screen |
| • 1280 X 960 | N; approx. 326KB/Screen, F; approx. 626KB/ Screen |
| • 640 X 480 | N; approx. 83KB/ Screen |

I/O Terminals

| | |
|-----------|--------------------|
| DC In | 3.8 V (AC Adapter) |
| Video Out | 1.0 Vp-p (75Ω) |

Memory Cards that can Record, Playback

| | |
|-------------|----------------------------------|
| Memory Type | SD Memory Card, Multi-Media Card |
|-------------|----------------------------------|

B. Optional Accessories

The Caplio RZ1 can be used with the items (sold separately) listed below.

| Item | Model | Remarks |
|--------------------------|---------|---|
| AC Adapter | AC-4b | Used for power supply from a home outlet to the camera. |
| PC Card Adapter | FM-SD53 | For when you want to load an SD Memory Card directly into your computer's PC Card Slot. |
| Rechargeable Battery | DB-50 | Available for this camera. |
| Rechargeable Battery Set | BS-5 | Includes the Rechargeable Battery (DB-50) and Battery Charger. |

Inserting the Rechargeable Battery (sold separately)

The rechargeable battery (DB-50) is another option for powering this camera. This battery is convenient because it can be used over and over again by recharging, and the battery power lasts long.

If you have already used this camera, make sure it is turned off before loading batteries.

- 1. Slide the battery/card cover toward the rear side to open it.**
- 2. Insert the rechargeable battery.**
- 3. Close the battery/card cover and slide it back into place.**

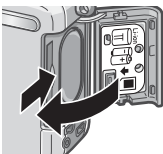
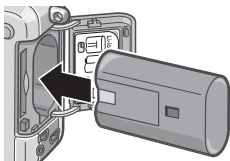

Removing the Rechargeable Battery.

1. **Open the battery/card cover.**
2. **Remove the rechargeable battery.**
3. **Close the battery/card cover and slide it back into place.**



Caution

- Please remove the rechargeable batteries if you are not going to use the camera for a long period of time.
- Store the removed battery in a dry cool place.
- Use only the dedicated battery charger to recharge the battery.

| Rechargeable battery charging time | |
|------------------------------------|--------------------------|
| DB-50 | About three hours (25°C) |

Using the AC Adapter (sold separately)

When shooting or viewing still images for a long time, or when connecting to your computer, using the AC Adapter (sold separately) is recommended.

If you have already used this camera, make sure it is turned off before loading the AC Adapter Battery.

1. **Open the battery/card cover.**
2. **Insert the AC Adapter Battery.**
3. **Open the power (DC input) cable cover and take the cable out.**
4. **Close the battery/card cover and slide it back into place.**
5. **Plug the power cord into an outlet.**

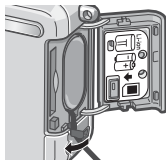
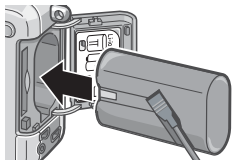

Removing the AC Adapter

Make sure the camera is turned off before removing the AC Adapter.

1. **Unplug the power plug from the outlet.**
2. **Slide the battery/card cover toward the rear side to open it.**
3. **Remove the battery.**
4. **Close the battery/card cover and slide it back into place.**



Caution

- Be sure to firmly attach cables and plug in cords.
- When you are not using the camera, unplug the AC Adapter from the camera and the power outlet.
- While in use, if you detach the AC Adapter or unplug it from the outlet, data may be lost.
- When using the AC Adapter, the battery level indication may not reach the full area.





C. Combination of Scene Mode and Function





Depending on the Scene Mode, the way functions work may differ from when in normal shooting mode. Refer to the table below.

| Mode Name | Flash | Macro Shooting |
|------------------|----------------------------|----------------|
| PORTRAIT | Initial setting: Flash Off | Disabled |
| SPORTS | Initial setting: Flash Off | Disabled |
| LANDSCAPE | Fixed on Flash Off | Disabled |
| NIGHTSCAPE | Forced flash is disabled | Disabled |
| | Initial setting: Auto | |
| TEXT MODE | Fixed on Flash Off | Enabled |
| HIGH SENSITIVITY | Fixed on Flash Off | Enabled |

D.Menu Items By Mode

Shooting Menu (Movie Mode)

| Setting | Option | Refer to |
|---------------|--|----------|
| Movie Size | [320], 160 | P.57 |
| Focus | [AF], MF, SNAP, ∞ | P.59 |
| White Balance | [AUTO],  (Daylight),  (Overcast),  (Tungsten light),  (Fluorescent light),  <h3>Shooting Menu (Scene Mode, except in Text Mode)</h3> | |

| Setting | Option | Refer to |
|------------------|--|----------|
| Pic Quality/Size | F2304, N2304, F1600, N1600, F1280,[N1280], N640 | P.57 |
| Focus | [AF], SNAP, ∞ (except in Landscape) | P.59 |
| Date Imprint | [Off], Date, Date and Time | P.69 |
| Exposure Comp. | -2.0 to +2.0 | P.52 |
| White Balance | [AUTO],  (Daylight),  (Overcast),  (Tungsten light),  (Fluorescent light), <h3>Shooting Menu (Text Mode)</h3> | |

| Setting | Option | Refer to |
|------------------|----------------------------|----------|
| Density | Deep, [Normal], Light | P.56 |
| Size | 2304, [1280] | P.57 |
| Date Imprint | [Off], Date, Date and Time | P.69 |
| SLOW SHUTTER LMT | [OFF], ON | P.68 |

E. Functions Whose Defaults will be Restored upon Power-off

Power-off may reset some function settings to their defaults. The table below indicates whether or not the function will be reset to its defaults upon power-off.

| Mode | Function | The current setting is kept:O, Restored:X |
|----------|-------------------------|---|
| Setup | DATE SETTINGS | O |
| | POWER SAVE | O |
| | AUTO POWER OFF | O |
| | BEEP SOUND | O |
| | SEQUENTIAL NO. | O |
| | LCD CONFIRM. | O |
| | LCD BRIGHTNESS | O |
| | LANGUAGE | O |
| | VIDEO OUT MODE | O |
| | ADJ. BUTT. SET. | O |
| | SHTG STGS WARNG. | O |
| Shooting | CONT. MODE | X |
| | EXPOSURE COMP. | O |
| | WHITE BALANCE | O |
| | PIC QUALITY/SIZE | O |
| | FOCUS | O |
| | PHOTOMETRY | O |
| | ISO SETTING | O |
| | SHARPNESS | O |
| | TIME EXPOSURE | O |
| | INTERVAL | X |
| | DATE IMPRINT | O |
| | SELF-TIMER | X |
| | FLASH | O |
| | MACRO SHOOTING | X |
| | DENSITY (Text Mode) | O |
| | SLOW SHUTTER LMT | O |
| | MOVIE SIZE (Movie Mode) | O |
| | SIZE (Text Mode) | O |

F. Number of Images That Can be Stored in Internal Memory/SD Memory Card

The following table shows the approximate number of images that can be recorded onto an SD memory card at various image size and picture quality settings.

| Mode | Picture Quality | Image Size | IN | 32MB | 64MB | 128MB | 256MB | 512MB |
|-------------|-----------------|-------------|----------------|----------------|----------------|-----------------|-----------------|-----------------|
| Still Image | F | 2304 X 1728 | 6 | 16 | 33 | 68 | 136 | 275 |
| | N | 2304 X 1728 | 12 | 31 | 64 | 130 | 260 | 523 |
| | F | 1600 X 1200 | 10 | 26 | 53 | 108 | 216 | 436 |
| | N | 1600 X 1200 | 20 | 51 | 104 | 211 | 421 | 849 |
| | F | 1280 X 960 | 15 | 38 | 79 | 159 | 318 | 641 |
| | N | 1280 X 960 | 29 | 72 | 149 | 301 | 600 | 1209 |
| | N | 640 X 480 | 128 | 315 | 645 | 1305 | 2600 | 5239 |
| TEXT MODE | | 2304 X 1728 | 20 | 51 | 104 | 211 | 421 | 849 |
| | | 1280 X 960 | 128 | 315 | 645 | 1305 | 2600 | 5239 |
| Movie | | 320 X 240 | 35 Seconds | 87 Seconds | 177 Seconds | 359 Seconds | 716 Seconds | 1444 Seconds |
| | | 160 X 120 | 129 Seconds | 318 Seconds | 651 Seconds | 1317 Seconds | 2624 Seconds | 5287 Seconds |



Note

- The number of remaining shots available may differ from the actual number of shots, depending on the subject.
- The maximum number of pictures and other numeric values may be different even for cards of the same capacity if the manufacturer, type, or shooting conditions are different.
- The continuous shooting (recording) time depends on the card type, capacity, and performance.

G. Using Your Camera Abroad

AC Adapter (Model AC-4b)

Can be used in regions with a current of 120V, 50Hz/60Hz.

If you are going to travel to a country that uses a different shaped wall outlet/plug, please consult your travel agent on a plug adapter suitable for wall outlets in your country of destination.

Warranty

This product is for domestic use. The warranty is only valid domestically.

Should the product fail or malfunction while you are abroad, the manufacturer assumes no responsibility for servicing the product locally or bearing the expenditure incurred therefore.

Using Playback on Television in other Regions

Playback is possible on televisions (or monitors) equipped with a video input terminal. Please use the video cable provided.

This camera is compatible with both NTSC and PAL television formats. Switch the video format on the camera to match the television environment in the region.

When you go overseas, set your camera to the local video format.

H. Cautions on Use

- This product is for domestic use. The warranty is only valid domestically.
- Should the product fail or malfunction while you are abroad, the manufacturer assumes no responsibility for servicing the product locally or bearing the expenditure incurred therefore.
- Be sure not to drop or apply any sudden force to the camera.
- Firing the flash consecutively may heat the firing unit. Do not fire it consecutively more than necessary.
- Do not fire the flash near eyes, or view the sun or other strong light directly through the viewfinder. It could cause visual impairment (particularly for infants).
- Do not fire the flash near the driver of a vehicle to avoid causing accidents.
- The batteries may become hot after extended use. Touching the batteries immediately after use could result in burns to your fingers.
- If the LCD monitor or panel is exposed to sunlight, they may become washed out and images may become hard to view.
- The LCD monitor and panel may contain some pixels that do not remain lit up continually in part or at all. Also, the brightness may become uneven because of the characteristics of LCDs. These are not failures.
- While you are carrying the camera, be careful not to hit it against other objects.
- In an environment where the temperature changes suddenly, condensation may occur in the camera, resulting in troubles such as fogging of the glass surface or malfunctions of the camera. If this occurs, place the camera in a bag to slow the temperature change as much as possible. Take it out of the bag after the temperature difference from the atmosphere has decreased to a fairly small amount.
- To avoid damaging the connectors, do not put any objects into the camera's microphone or speaker holes.



Note

Conditions in which condensation may easily occur:

- When the camera is moved to an environment where the temperature differs greatly.
- In humid places
- In a room immediately after being heated, or when the camera is exposed directly to cooled air from an air-conditioner or another similar appliance

I. Care and Storage

Care

- Please note that if fingerprints, dirt, etc. get onto the lens, picture quality will suffer.
- When dust or dirt does get on the lens, do not touch it directly with your fingers, and either use a blower (available in stores) to blow it off, or a soft cloth to gently dust it off.
- After use at the beach or around chemicals, wipe it off particularly carefully.
- In the unlikely event that your camera fails to work properly, please consult your Ricoh Repair Center.

There are high voltage circuits in this camera. As this is dangerous, do not dismantle this camera under any circumstances.

- Do not get volatile substances, such as thinner, benzene, or pesticides on your camera. This may cause a change in quality, paint to peel, etc.
- As the surface of the LCD Monitor is easily scratched, do not rub hard objects against it.
- Please clean the surface of the LCD Monitor with solvents available on the market specially for cleaning LCD display surfaces. Gently wipe with a soft cloth dampened with a little cleaner.

Storage

- Please avoid storing your camera in the following kinds of places, as breakdown may result.
 - In high heat and humidity, or where there is severe change in temperature or humidity.
 - Places with a lot of dust, dirt or sand.
 - Places with severe vibration.
 - In places of direct contact with vinyl products, rubber or chemicals, such as insect repellent, etc.
 - Places with strong magnetic fields (monitors, next to strong magnets, etc.).
- If you are using a battery or batteries, remove them if you are not going to use the camera for a long period of time.

Precautions regarding care of your camera

1. Be sure to turn the power off.
2. Remove the batteries or AC Adapter before caring for your camera.

J. Error Messages

If an error message is displayed on the LCD Monitor, take the corresponding action.

| Error Message | Cause and Action | Page |
|--|--|------------------|
| INSERT CARD | No card is loaded. Insert a card. | P.20 |
| SET THE DATE ON THE SETUP MENU | The date is not set. Set the date. | P.100 |
| FILE NUMBER OVER | The file number limit has been exceeded. Please use another card, or delete unwanted files. | P.97 |
| UNMATCHED FILE | A file that cannot be played back was selected. | - |
| INSUFFICIENT MEMORY. CONTINUE? | Because there is not sufficient capacity on the card, all the files cannot be copied. Use another card. | P.19 |
| PROTECTED | You are trying to delete a protected file. | P.79 |
| THE CARD IS WRITE-PROTECTED. | The card is "Locked (write-protection)". Unlock the card. | P.19 |
| PRINT SETTINGS CANNOT BE SET FOR THIS FILE | This file (movies and other) cannot be selected for printing. | - |
| INSUFFICIENT MEMORY | Files cannot be stored. Make sure there is enough free space, or delete files. | P.40, P.90, P.91 |
| | The image print number limit has been exceeded. Select an image and set the number to 0. | - |
| FORMAT INTERNAL MEMORY | It is necessary to format internal memory. | P.91 |
| FORMAT CARD | The card is not formatted.Format the card. | P.90 |
| CARD ERROR | Please reformat. If, after doing so, the error message still appears, the card may be faulty. Do not use the card. | P.90 |
| WRITE TO CARD | Writing file to memory. Wait until writing finishes. | - |
| NO FILE | There are no files that can be played back. | - |
| CANNOT RECORD | The Number of remaining shots is 0. Switch to another card or internal memory. | - |
| INSUFFICIENT MEMORY CANNOT RECORD | Files cannot be stored. Make sure there is enough free space, or delete files. | P.40, P.90, P.91 |

K. Warranty and Servicing

1. This product is backed by a limited warranty. During the warranty period mentioned in the Warranty supplied with your camera, any defective parts will be repaired free of charge. In the event of a camera malfunction, contact the dealer from which you purchased the camera or your nearest Ricoh service office. Please note that you will be not be reimbursed for the cost of bringing the camera to the Ricoh service office.
2. This warranty does not cover any damage resulting from:
 - 1) failure to follow the instructions in the instruction manual;
 - 2) repair, modification or overhaul not conducted by an authorized service center listed in the instruction manual;
 - 3) fire or natural disaster;
 - 4) improper storage, such as exposing the camera to high temperatures, humidity, or moth-balls; storing it with a leaking battery; storing the camera in a dirty condition so that it becomes moldy; or otherwise insufficiently caring for the camera;
 - 5) submergence; exposure to floods or spilled alcohol or other beverages; allowing sand or mud to enter the camera; exposure to physical shocks; or dropping the camera.
3. After the warranty period has passed, you will be liable for all repair fees, including those incurred at an authorized service center.
4. You will be liable for all repair fees, even within the warranty period, if the warranty card is not attached or if the distributor's name or the purchase date have been changed or are not indicated on the card.
5. Expenses for overhaul and thorough inspection by special request of the customer will be charged to the customer, whether or not they are incurred during the warranty period.
6. This warranty only applies to the camera and not to the accessories, such as the case and strap, nor does it apply to the battery and other consumables provided.
7. Any consequential damages arising from failure of the camera, such as expenses incurred in taking pictures or loss of expected profit, will not be reimbursed whether they occur during the warranty period or not.
8. The warranty is only valid domestically.
 - *The above provisions refer to repairs offered free of charge, and do not limit your legal rights.
 - *The intention of the above provisions is also described in the warranty card provided with this camera.
9. Parts essential to the servicing of the camera (that is, components required to maintain the functions and quality of the camera) will be available for a period of five years after the camera is discontinued.
10. Please note that if the camera is seriously damaged by flooding, submergence, infiltration of sand or mud, violent shocks or dropping, it may not be repairable, and restoration to its original condition may be impossible.



Note

- Before sending the camera in for repair, check the battery and read the instruction manual again to ensure proper operation.
- Some repairs require a significant amount of time to be completed.
- When sending the camera to a service center, please include a note which describes the defective part and the problem as precisely as possible.
- Remove all accessories not related to the problem before sending the camera to the service center.
- Before taking any important pictures (such as at weddings, on trips abroad, etc.), test the camera to check operation and ensure proper functioning. We recommend that you keep this manual and spare battery on hand.
- This warranty does not apply to data stored on an SD Memory Card or in internal memory.

Index

A

| | |
|----------------------|---------|
| AC Adapter | 11, 134 |
| Acrobat Reader | 107 |
| ADJ BTN.SET. | 93 |
| ADJ. Button | 49 |
| AUTO POWER OFF | 96 |
| Auto Power Off | 21 |

B

| | |
|---------------------|-----|
| BEEP SOUND | 94 |
| Browse CD-ROM | 107 |

C

| | |
|------------------------------|--------------|
| Caplio Software CD-ROM | 11, 106, 118 |
| CaplioViewer | 107 |
| CONT (Multi-Shot) | 71 |
| COPY TO CARD | 86 |

D

| | |
|--------------------|-----|
| DATE IMPRINT | 69 |
| DENSITY | 56 |
| Digital Zoom | 30 |
| Direct Print | 44 |
| DirectX | 107 |
| DPOF | 82 |

E

| | |
|---------------------|-----|
| Erasing | 40 |
| Error Message | 142 |
| EXPOSURE COMP. | 52 |

F

| | |
|-------------------------|----|
| Flash | 32 |
| FOCUS | 59 |
| Focus-lock | 28 |
| FORMAT - CARD | 90 |
| FORMAT - INT. MEM. | 91 |

G

| | |
|------------------|----|
| Grid Guide | 24 |
|------------------|----|

H

| | |
|------------------------------|----|
| Half-press | 26 |
| Handstrap | 10 |
| Histogram On | 24 |
| How to Hold the Camera | 25 |

I

| | |
|------------------|----|
| Image Size | 57 |
| INTERVAL | 66 |

| | |
|-------------------|----|
| ISO SETTING | 55 |
|-------------------|----|

L

| | |
|----------------------|----|
| LCD BRIGHTNESS | 92 |
| LCD CONFIRM. | 95 |

M

| | |
|--------------------------------------|----------|
| Macro-Mode | 31 |
| Magnifying Images | 37 |
| Mounter | 107, 119 |
| M (Memory-reversal) Multi-Shot | 71 |

N

| | |
|---|-----|
| Number of Images That Can be Stored in Internal Memory/SD Memory Card | 138 |
|---|-----|

P

| | |
|----------------------------|----|
| Packing List | 10 |
| PHOTOMETRY | 63 |
| PIC QUALITY/SIZE | 57 |
| PictBridge | 44 |
| Picture Quality Mode | 57 |
| POWER-SAVE | 98 |
| Power-Save Mode | 21 |
| PROTECT | 79 |

R

| | |
|----------------------------|----------|
| Rechargeable Battery | 11, 133 |
| RESIZE | 85 |
| RESTORE DEFAULTS | 70 |
| RICOH Gate La | 107, 119 |

S

| | |
|----------------------------------|-----|
| Scene | 33 |
| SD Memory Card | 19 |
| Self-timer | 64 |
| SEQUENTIAL NO. | 97 |
| Sharpness | 62 |
| Shooting Menu (Movie Mode) | 136 |
| SLIDE SHOW | 78 |
| SLOW SHUTTER LMT | 68 |
| Specifications | 131 |
| Synchro-Monitor Mode | 24 |
| S (Stream) Multi-Shot | 71 |

T

| | |
|-------------------------|-----|
| Thumbnail Display | 36 |
| TIME EXPOSURE | 65 |
| Trouble | 126 |
| Troubleshooting | 126 |

U

| | |
|--------------------|-----|
| Uninstalling | 117 |
|--------------------|-----|

| | |
|------------------|----------|
| USB Cable | 10 |
| USB Driver | 107, 119 |

V

| | |
|-------------------|--------|
| VIDEO cable | 10, 38 |
|-------------------|--------|

W

| | |
|------------------------------|-----|
| Warranty and Servicing | 143 |
| White Balance | 53 |
| WIA Driver | 107 |

Z

| | |
|------------|----|
| Zoom | 30 |
|------------|----|

Telephone Support Numbers in Europe

| | | |
|-------------|--------------------------|-------------------|
| UK | (from within the UK) | 02073 656 580 |
| | (from outside of the UK) | +44 2073 656 580 |
| Deutschland | (innerhalb Deutschlands) | 06331 268 438 |
| | (außerhalb Deutschlands) | +49 6331 268 438 |
| France | (à partir de la France) | 0800 91 4897 |
| | (en dehors de la France) | +49 6331 268 409 |
| Italia | (dall'Italia) | 02 696 33 451 |
| | (dall'estro) | +39 02 696 33 451 |
| España | (desde España) | 91 406 9148 |
| | (desde fuera de España) | +34 91 406 9148 |
| Nederland | (binnen Nederland) | 0800 022 9494 |
| | (vanuit het buitenland) | +49 6331 268 443 |

<http://www.service.ricohpmmc.com/>

From environmental friendliness to environmental conservation and to environmental management

Ricoh is aggressively promoting environment-friendly activities and also environment conservation activities to solve the great subject of management as one of the citizens on our precious earth.



To reduce the environmental loads of digital cameras, Ricoh is also trying to solve the great subjects of "Saving energy by reducing power consumption" and "Reducing environment-affecting chemical substances contained in products." Easy and simple manuals and CD-ROM approach are part of the solution.

If a problem arises

First of all, see "Troubleshooting" in this manual. If the issues still persist, please contact a Ricoh office.

| Ricoh Offices | |
|--|---|
| Ricoh Company, Ltd. | 3-2-3, Shin-Yokohama Kohoku-ku, Yokohama-shi 222-8530, Japan http://www.ricoh.co.jp/r_dc |
| Ricoh Corporation | 5 Dedrick Place West Caldwell, NJ 07006, USA 1-800-22RICOH http://www.ricoh-usa.com |
| RICOH EUROPE B.V. (PMMC) | Oberrather Straße 6, D-40472, Düsseldorf, Germany http://www.ricohpmmc.com |
| RICOH UK LTD. (PMMC UK) | Ricoh House, 1 Plane Tree Crescent, Feltham, Middlesex, TW13 7HG, England |
| RICOH FRANCE S.A. (PMMC FRANCE) | 383, Avenue du Général de Gaulle – BP 307-931-13 Clamart Cédex, France |
| RICOH ESPANA, S.A. (PMMC SPAIN) | Av. Litoral Mar, 12-14, 08005 Barcelona, Spain |
| RICOH EUROPE B.V. (PMMC BENELUX) | Koolhovenlaan 35, 1119 NB Schiphol-Rijk, The Netherlands |
| Ricoh Italia S.p.A. (PMMC ITALY) | via Ponchielli, 3 20063 Cernusco S/N Milano Italy |
| RICOH HONG KONG LIMITED Personal Multimedia Products Center | 21/F., Tai Yau Building, 181 Johnston Road, Wan Chai, Hong Kong |
| Ricoh Australia Pty. Ltd. | 8 Rodborough Road Frenchs Forrest, N.S.W.2086 Australia http://www.ricoh.com.au |

Ricoh Company, Ltd.
15-5, Minami Aoyama 1-chome,
Minato-ku, Tokyo 107-8544, Japan
August 2004

EN (USA) GB (GB) AE (AE)
Printed in China



* L 7 2 0 2 9 7 1 *