

DVD Recorder

Operating Instructions

RDR-GXD310



Important Information

Should you experience a problem with this recorder, please refer to the trouble shooting section on page 88. If you are unable to rectify the problem, contact the Sony Customer Information Centre on

08705 111 999

(Monday-Friday from 8:30am to 6:00pm)

Please ensure you have the following information available before calling the helpline:

- Date of purchase: -----
- Serial number: -----
- Model number: -----
- Post code: -----
- Detailed fault description: -----
- Signal strength and signal quality: -----

Notes:

- You can check the signal strength and signal quality using the menu system of this recorder. Page 75 explains how to display the main menu on screen, and page 78 explains how to obtain the signal strength display. The serial number and the model number are located on the rear of the recorder.
- This recorder is only designed for use in the United Kingdom. Compliance with digital terrestrial TV broadcast standards in other countries is not guaranteed.

WARNING

To prevent fire or shock hazard, do not expose the unit to rain or moisture. To avoid electrical shock, do not open the cabinet. Refer servicing to qualified personnel only. The mains lead must only be changed at a qualified service shop.



This appliance is classified as a CLASS 1 LASER product. The CLASS 1 LASER PRODUCT MARKING is located on the laser protective housing inside the enclosure.



Disposal of Old Electrical & Electronic Equipment (Applicable in the European Union and other European countries with separate collection systems)

This symbol on the product or on its packaging indicates that this product shall not be treated as household waste. Instead it shall be handed over to the applicable collection point for the recycling of electrical and electronic equipment. By ensuring this product is disposed of correctly, you will help prevent potential negative consequences for the environment and human health, which could otherwise be caused by inappropriate waste handling of this product. The recycling of materials will help to conserve natural resources. For more detailed information about recycling of this product, please contact your local Civic Office, your household waste disposal service or the shop where you purchased the product.

CAUTION

The use of optical instruments with this product will increase eye hazard. As the laser beam used in this DVD recorder is harmful to eyes, do not attempt to disassemble the cabinet. Refer servicing to qualified personnel only.

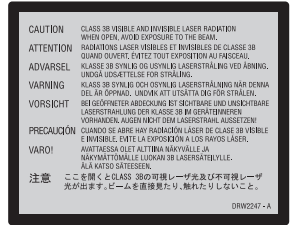

This label is located on the laser protective housing inside the enclosure.

Notice for customers in the United Kingdom and Republic of Ireland

A moulded plug complying with BS1363 is fitted to this equipment for your safety and convenience. Should the fuse in the plug supplied need to be replaced, a 5 AMP fuse approved by ASTA or BSI to BS1362, (i.e., marked with Ⓢ or Ⓡ mark) must be used. If the plug supplied with this equipment has a detachable fuse cover, be sure to attach the fuse cover after you change the fuse. Never use the plug without the fuse cover. If you should lose the fuse cover, please contact your nearest Sony service station.

Precautions

- This unit operates on 220 – 240 V AC, 50/60 Hz. Check that the unit's operating voltage is identical with your local power supply. To prevent fire or shock hazard, do not place objects filled with liquids, such as vases, on the apparatus.

Precautions

This equipment has been tested and found to comply with the limits set out in the EMC Directive using a connection cable shorter than 3 metres.

On safety

Should any solid object or liquid fall into the cabinet, unplug the recorder and have it checked by qualified personnel before operating it any further.

On power sources

- The recorder is not disconnected from the AC power source (mains) as long as it is connected to the wall outlet, even if the recorder itself has been turned off.
- If you are not going to use the recorder for a long time, be sure to disconnect the recorder from the wall outlet. To disconnect the AC power cord (mains lead), grasp the plug itself; never pull the cord.

On placement

- Place the recorder in a location with adequate ventilation to prevent heat build-up in the recorder.
- Do not place the recorder on a soft surface such as a rug that might block the ventilation holes.
- Do not place the recorder in a confined space such as a bookshelf or similar unit.
- Do not place the recorder in a location near heat sources, or in a place subject to direct sunlight, excessive dust, or mechanical shock.
- Do not place the recorder in an inclined position. It is designed to be operated in a horizontal position only.
- Keep the recorder and discs away from equipment with strong magnets, such as microwave ovens, or large loudspeakers.
- Do not place heavy objects on the recorder.

On recording

- Note that the contents of the recording cannot be compensated for under any and all conditions, including conditions that may arise due to a malfunction of this unit.
- Make trial recordings before making the actual recording.

Copyrights

- Television programmes, films, video tapes, discs, and other materials may be copyrighted. Unauthorized recording of such material may be contrary to the provisions of the copyright laws. Also, use of this recorder with cable television transmission may require authorization from the cable television transmitter and/or programme owner.
- This product incorporates copyright protection technology that is protected by U.S. patents and other intellectual property rights. Use of this copyright protection technology must be authorized by Macrovision, and is intended for home and other limited viewing uses only unless otherwise authorized by Macrovision. Reverse engineering or disassembly is prohibited.

Copy guard function

Since the recorder has a copy guard function, programmes received through an external tuner (not supplied) may contain copy protection signals (copy guard function) and as such may not be recordable, depending on the type of signal.

IMPORTANT NOTICE

Caution: This recorder is capable of holding a still video image or on-screen display image on your television screen indefinitely. If you leave the still video image or on-screen display image displayed on your TV for an extended period of time you risk permanent damage to your television screen. Plasma display panels and projection televisions are especially susceptible to this.

If you have any questions or problems concerning your recorder, please consult your nearest Sony dealer.

About this manual

- In this manual “disc” is used as a general reference for the DVDs, or CDs unless otherwise specified by the text or illustrations.
- Instructions in this manual describe the controls on the remote. You can also use the controls on the recorder if they have the same or similar names as those on the remote.
- The on-screen display illustrations used in this manual may not match the graphics displayed on your TV screen.
- The explanations regarding DVDs in this manual refer to DVDs created on this recorder. The explanations do not apply to DVDs that are created on other recorders and played back on this recorder.

Table of Contents

Important Information	2
WARNING	2
Precautions	3
Ways to Use Your DVD Recorder	7
Quick Guide to Disc Types	8
Recordable and playable discs	8
Playable discs	10

Hookups and Settings	12
Hooking Up the Recorder	12
Step 1: Unpacking	12
Step 2: Connecting the Aerial Cable	13
Step 3: Connecting the Video Cords	14
About the SMARTLINK features (for SCART connections only)	15
Using the PROGRESSIVE button	16
Step 4: Connecting the Audio Cords	17
Step 5: Connecting the Mains Lead	18
Step 6: Preparing the Remote	19
Controlling TVs with the remote	19
Controlling the volume of your AV amplifier (receiver) with the remote	20
If you have a Sony DVD player or more than one Sony DVD recorder	21
Step 7: Easy Setup	22
Connecting a VCR or Similar Device	23
Connecting to the LINE 3 jack	23
Connecting to the LINE 2 IN or LINE 4 IN jacks	24
Connecting to a Satellite or Digital Tuner	25

Seven Basic Operations — Getting to Know Your DVD Recorder

1. Inserting and Formatting a DVD Disc (Disc Info)	26
Inserting a Disc	26
Formatting a DVD disc (Disc Info)	26
2. Recording a Programme	28
Checking the disc status while recording	29
3. Playing the Recorded Programme (Title List)	29
4. Displaying the Playing Time and Play Information	31
Checking the playing/remaining time	32
5. Changing the Name of a Recorded Programme	33
6. Labelling and Protecting a Disc	35
Labelling a disc	35
Protecting a disc	35
7. Playing the Disc on Other DVD Equipment (Finalise)	36
Unfinalising a disc	37

Guide to Digital Services	38
EPG (Electronic Programme Guide)	38
Viewing a list of available channels	38
Viewing programmes related to a specific category	39
Programme information	40
Displaying the programme information	40
Viewing a digital text service	41
Selecting digital text from dedicated digital teletext channels	41
Selecting digital text from other channels	42
Favourites	42
Setting a favourite list	42
Moving to a different favourite list	43
Watching or listening to a favourite channel	43
Index	44
<hr/>	
Timer Recording	45
Before Recording	45
Recording mode	45
Unrecordable pictures	45
Timer Recording (Standard/EPG)	46
Setting the timer manually (Standard)	46
Recording TV programmes using the EPG application	48
Using the Quick Timer function	49
Adjusting the recording picture quality and size	50
Creating chapters in a title	51
Checking/Changing/Canceling Timer Settings (EPG)	51
Checking/Changing/Canceling Timer Settings (Timer List)	52
Recording From Connected Equipment	54
Recording from connected equipment with a timer (Synchro Rec)	54
Recording from connected equipment without a timer	55
<hr/>	
Playback	56
Playing	56
Playback options	58
Adjusting the picture quality	59
Adjusting the sound quality	60
Playing from the beginning of the programme you are recording (Chasing Playback)	61
Playing a previous recording while making another (Simultaneous Rec and Play)	61
Searching for a Title/Chapter/Track, etc.	62
Searching by Thumbnail (Visual Search)	62
Searching by title number or time code	62
Playing MP3 Audio Tracks or JPEG Image Files	63
Selecting an MP3 album or track	63
Selecting a JPEG album or image	64
About MP3 audio tracks and JPEG image files	65
MP3 audio tracks or JPEG image files that the recorder can play	65
About playback order of albums, tracks, and files	66

Erasing and Editing	67
Before Editing	67
Edit options for DVD-RWs (VR mode)	67
Edit options for DVD+RWs/DVD-RWs (Video mode)/DVD+Rs/DVD-Rs	68
Erasing and Editing a Title	68
Erasing a chapter (Delete Chapter)	69
Erasing a section of a title (A-B Erase)	69
Erasing multiple titles (Erase Titles)	70
Erasing all titles on the disc	70
Erasing titles to open up disc space (Disc Map)	70
Creating chapters manually	71
Creating and Editing a Playlist	71
Moving a Playlist title (Change Order)	72
Combining multiple Playlist titles (Combine)	72
Dividing a Playlist title (Divide)	73

Settings and Adjustments	74
Clock and Language Settings (Settings)	74
Clock	74
Language	74
Digital TV settings (DTV Settings)	75
Favourites	75
Parental Lock	75
Tuning	76
Technical Information	78
Video Settings (Video)	79
Audio Settings (Audio)	81
Recording and Parental Control Settings (Features)	83
Parental Control (Password)	85
Disc and Remote Control Settings/Factory Settings (Options)	85
Easy Setup (Resetting the Recorder)	87

Additional Information	88
Troubleshooting	88
Self-diagnosis Function (When letters/numbers appear in the display)	93
Notes About This Recorder	93
Specifications	95
Guide to Parts and Controls	96
Glossary	100
Language Code List	102
Area Code	102
Digital TV Channel List	103
Index	104

Ways to Use Your DVD Recorder

Recording/Playback

Compatible media and reference pages

**Quick access to recorded titles
– Title List**



+RW **-RWVR** **-RW_{Video}** **+R** **-R**

“3. Playing the Recorded Programme (Title List)” on page 29

**Play the beginning of a title
while it is being recorded
– Chasing Playback**



-RWVR

“Playing from the beginning of the programme you are recording (Chasing Playback)” on page 61

**Watching one title while
recording another
– Simultaneous Rec and Play**



+RW **-RWVR** **-RW_{Video}** **+R** **-R**
VCD **CD** **DATA DVD** **DATA CD**

“Playing a previous recording while making another (Simultaneous Rec and Play)” on page 61

Editing

Compatible media and reference pages

**Creating your own programme
– Playlist**















-RWVR

“Creating and Editing a Playlist” on page 71

A list of recordable and playable discs is on page 8.

Quick Guide to Disc Types

Recordable and playable discs

Type	Disc Logo	Icon used in this manual	Formatting (new discs)	Compatibility with other DVD players (finalising)
DVD+RW	 DVD+ReWritable  DVD+ReWritable		Automatically formatted in +VR mode	Playable on DVD+RW compatible players (automatically finalised)
DVD-RW	 DVD-RW		Format in VR mode (page 26)	Playable only on VR mode compatible players (finalisation unnecessary)
	 DVD-RW 		Format in Video mode (page 26)	Playable on most DVD players (finalisation necessary) (page 36)
DVD+R	 DVD+R		Automatically formatted	Playable on most DVD players (finalisation necessary) (page 36)
DVD+R DL	 DVD+R DL			
DVD-R	 DVD-R R4.7		Automatically formatted	Playable on most DVD players (finalisation necessary) (page 36)

Usable disc versions (as of March 2005)

- 8x-speed or slower DVD+RWs
 - 6x-speed or slower DVD-RWs (Ver.1.1, Ver.1.2 with CPRM^{*1})
 - 16x-speed or slower DVD+Rs
 - 16x-speed or slower DVD-Rs (Ver.2.0, Ver.2.1)
 - 2.4x-speed DVD+R DL (Double Layer) discs
- “DVD+RW,” “DVD-RW,” “DVD+R,” “DVD+R DL,” and “DVD-R” are trademarks.

^{*1} CPRM (Content Protection for Recordable Media) is a coding technology that protects copyrights for images.

^{*2} This logo applies to 4x and 6x speed DVD-RW discs.

	Recording Features				Editing Features			
	Rewrite (page 45)	Auto Chapter (page 83)	Manual Chapter (page 71)	Record 16:9 sizes (page 50)	Change title name (page 68)	Delete title (page 70)	A-B Erase (page 69)	Playlist (page 71)
	Yes	Yes	No	No	Yes	Yes	Yes	No
	Yes	Yes	Yes	Yes	Yes	Yes	Yes	Yes
	Yes	Yes	No	Yes ^{*3}	Yes	Yes	No	No
	No	Yes	No	No	Yes	Yes ^{*4}	No	No
	No	Yes	No	Yes ^{*3}	Yes	Yes ^{*4}	No	No









Discs that cannot be recorded on

- 8 cm discs
- DVD-Rs in VR mode (Video Recording format)

^{*3} Only if the recording mode is LSP, SP, HSP, or HQ.

^{*4} Erasing titles does not free up disc space.

Playable discs

Type	Disc Logo	Icon used in this manual	Characteristics
DVD VIDEO			Discs such as movies that can be purchased or rented
VIDEO CD			VIDEO CDs or CD-Rs/CD-RWs in VIDEO CD/Super VIDEO CD format
CD			Music CDs or CD-Rs/CD-RWs in music CD format that can be purchased
DATA DVD	—		DVD+RWs/DVD+Rs/DVD-RWs/DVD-Rs/DVD-ROMs containing JPEG image files
DATA CD	—		CD-ROMs/CD-Rs/CD-RWs containing MP3 audio tracks or JPEG image files
8 cm DVD+RW/ DVD-RW/DVD-R	—	—	8 cm DVD+RW, DVD-RW, and DVD-R recorded with a DVD video camera. (Still images recorded with a DVD video camera cannot be played.)

“DVD VIDEO” and “CD” are trademarks.

Discs that cannot be played

- PHOTO CDs
- CD-ROMs/CD-Rs/CD-RWs that are not recorded in music CD or Video CD format, or do not contain MP3 or JPEG files
- Data part of CD-Extras
- DVD-ROMs that do not contain JPEG files or are not in DVD Video format
- DVD Audio discs
- DVD-RAMs
- HD layer on Super Audio CDs
- DVD VIDEOS with a different region code (page 11)
- DVD-Rs recorded in VR mode (Video Recording format)

Maximum recordable number of titles

Disc	Number of titles*
DVD-RW/DVD-R	99
DVD+RW/DVD+R	49
DVD+R DL	49

* The maximum length for each title is eight hours.

Note on playback operations of DVD VIDEOS/VIDEO CDs

Some playback operations of DVD VIDEOS/VIDEO CDs may be intentionally set by software producers. Since this recorder plays DVD VIDEOS/VIDEO CDs according to the disc contents the software producers designed, some playback features may not be available. Also, see the instructions supplied with the DVD VIDEOS/VIDEO CDs.

Region code (DVD VIDEO only)

Your recorder has a region code printed on the rear of the unit and will only play DVD VIDEOS (playback only) labelled with identical region codes. This system is used to protect copyrights. DVD VIDEOS labelled  will also play on this recorder.

If you try to play any other DVD VIDEO, the message “Playback prohibited by region code.” will appear on the TV screen. Depending on the DVD VIDEO, no region code indication may be labelled even though playing the DVD VIDEO is prohibited by area restrictions.



Region code

Music discs encoded with copyright protection technologies

This product is designed to play back discs that conform to the Compact Disc (CD) standard. Recently, various music discs encoded with copyright protection technologies are being marketed by some record companies. Please be aware that among those discs, there are some that do not conform to the CD standard and may not be playable by this product.

Note on DualDiscs

A DualDisc is a two sided disc product which mates DVD recorded material on one side with digital audio material on the other side.

However, since the audio material side does not conform to the Compact Disc (CD) standard, playback on this product is not guaranteed.

⚡ Notes

- Some DVD+RWs/DVD+Rs, DVD-RWs/DVD-Rs, or CD-RWs/CD-Rs cannot be played on this recorder due to the recording quality or physical condition of the disc, or the characteristics of the recording device and authoring software. The disc will not play if it has not been correctly finalised. For more information, see the operating instructions for the recording device.
- You cannot mix VR mode and Video mode on the same DVD-RW. To change the disc's format, reformat the disc (page 26). Note that the disc's contents will be erased after reformatting.
- You cannot shorten the time required for recording even with high-speed discs.
- It is recommended that you use discs with “For Video” printed on their packaging.
- You cannot add new recordings to DVD+Rs, DVD-Rs, or DVD-RWs (Video mode) that contain recordings made on other DVD equipment.
- In some cases, you may not be able to add new recordings to DVD+RWs that contain recordings made on other DVD equipment. If you do add a new recording, note that this recorder will rewrite the DVD menu.
- You cannot edit recordings on DVD+RWs, DVD-RWs (Video mode), DVD+Rs, or DVD-Rs that are made on other DVD equipment.
- If the disc contains PC data unrecognizable by this recorder, the data may be erased.
- You may not be able to record on some recordable discs, depending on the disc.

Hooking Up the Recorder

Follow steps 1 to 7 to hook up and adjust the settings of the recorder.

Notes

- Plug cords securely to prevent unwanted noise.
- Refer to the instructions supplied with the components to be connected.
- You cannot connect this recorder to a TV that does not have a SCART or video input jack.
- Be sure to disconnect the mains lead of each component before connecting.

Step 1: Unpacking

Check that you have the following items:

- Audio/video cord (phono plug × 3 ↔ phono plug × 3) (1)
- Mains lead (1)
- Aerial cable (1)
- Remote commander (remote) (1)
- R6 (size AA) batteries (2)

Step 2: Connecting the Aerial Cable

Connect the aerial cable by following the steps below. Do not connect the mains lead until you reach “Step 5: Connecting the Mains Lead” on page 18.

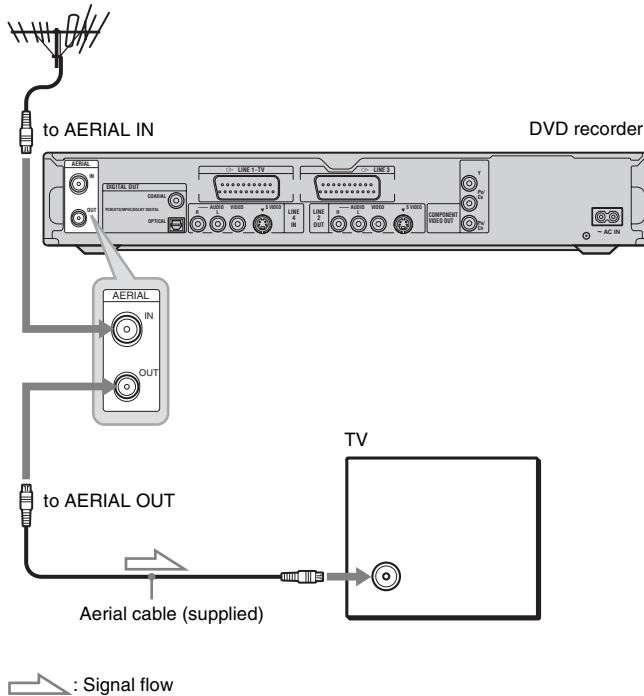

- 1** Disconnect the aerial cable from your TV and connect it to AERIAL IN on the rear panel of the recorder.
- 2** Connect AERIAL OUT of the recorder to the aerial input of your TV, using the supplied aerial cable.

Step 3: Connecting the Video Cords

Select one of the following patterns **A** through **D**, according to the input jack on your TV monitor, projector, or AV amplifier (receiver). This will enable you to view pictures.

A Connecting to a SCART input jack

When you set “Line1 Output” to “S Video” or “RGB” in “Easy Setup” (page 22), use a SCART cord that conforms to the selected signal.

B Connecting to a video input jack

You will enjoy standard quality images.

C Connecting to an S VIDEO input jack

You will enjoy high quality images.

D Connecting to component video input jacks (Y, Pb/Cb, Pr/Cr)

You will enjoy accurate colour reproduction and high quality images.

If your TV accepts progressive 525p/625p format signals, you must use this connection and set “Component Out” in “Video” setup to “On” (page 79). Then press PROGRESSIVE on the remote to send progressive video signals. For details, see “Using the PROGRESSIVE button” on page 16.

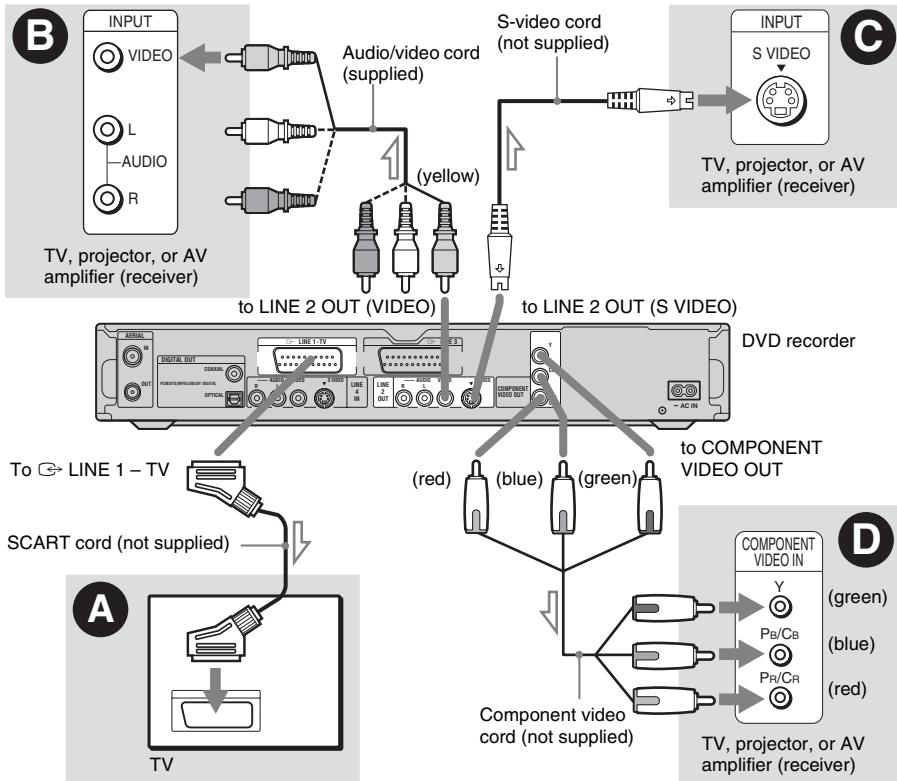

: Signal flow

When playing “wide screen” images

Some recorded images may not fit your TV screen. To change the picture size, see page 79.

If you are connecting to a VCR

Connect your VCR to the LINE 3 jack on the recorder (page 23).



Notes

- Do not connect more than one type of video cord between the recorder and your TV at the same time.
- You cannot use the PROGRESSIVE button with the connections **B** and **C**.
- When you connect the recorder to your TV via the SCART jacks, the TV’s input source is set to the recorder automatically when you start playback. If necessary, press  TV/VIDEO to return the input to the TV.
- For correct SMARTLINK connection, you will need a SCART cord that has the full 21 pins. Refer to your TV’s instruction manual as well for this connection.
- If you connect this recorder to a TV with SMARTLINK, set “Line1 Output” to “Video” in “Easy Setup.”

About the SMARTLINK features (for SCART connections only)

If the connected TV (or other connected equipment such as a set top box) complies with SMARTLINK, NexTVView Link^{*3}, MEGALOGIC^{*1}, EASYLINK^{*2}, CINEMALINK^{*2}, Q-Link^{*3}, EURO VIEW LINK^{*4}, or T-V LINK^{*5}, this recorder automatically runs the SMARTLINK function after you complete the connection pattern **A** on page 14 (the SMARTLINK indicator lights up when you turn on your TV). You can enjoy the following SMARTLINK features.

- **TV Direct Rec**
You can easily record what you are watching on your TV (page 28).
- **One Touch Play**
You can turn on the recorder and TV, set the TV’s input to the recorder, and start playback with one touch of the  (play) button (page 57).
- **One Touch Menu**
You can turn on the recorder and TV, set the TV to the recorder’s channel, and display the Title List menu with one touch of the TITLE LIST button (page 57).

- **One Touch Timer**
You can turn on the recorder and TV, set the TV to the recorder’s channel, and display the timer programming menu with one touch of the  (TIMER) button (page 47).
- **Automatic Power Off**
The recorder will turn off automatically if the recorder is not used after you turn off the TV.
- **One Touch EPG**
You can turn on the recorder and TV, set the TV to the recorder’s channel, and display the Electronic Programme Guide screen with one touch of the  (GUIDE) button on the remote (page 38).
- **EPG Title Download**
The recorder will automatically download and set the title of the programme being recorded from LINE 1 according to the title name displayed in the EPG of the connected TV or STB..

*1 “MEGALOGIC” is a registered trademark of Grundig Corporation.

*2 “EASYLINK” and “CINEMALINK” are trademarks of Philips Corporation.

*3 “Q-Link” and “NexTVView Link” are trademarks of Panasonic Corporation.

*4 “EURO VIEW LINK” is a trademark of Toshiba Corporation.

*5 “T-V LINK” is a trademark of JVC Corporation.

Hint

SMARTLINK also works with TVs or other equipment having EPG Timer Control, EPG Title Download, and Now Recording functions. For details, refer to the operating instructions supplied with your TV or other equipment.

Notes

- The SMARTLINK features are available only when “Video” is selected in “Line1 Output.”
- The SMARTLINK features are not available for devices connected via the DVD recorder’s LINE 3 jack.
- The SMARTLINK features are not available when “Power Save” is set to “On” (page 86).
- Not all TVs respond to the functions above.

Using the PROGRESSIVE button

By using the PROGRESSIVE button, you can select the signal format in which the recorder outputs video signals: interlace or progressive.

- 1 Connect the recorder using the COMPONENT VIDEO OUT jacks (pattern  on page 14).
- 2 Set “Component Out” in “Video” setup to “On” (page 79).
- 3 Press the PROGRESSIVE button.
“PROGRESSIVE” appears in the front panel display when the recorder outputs progressive signals.

◆ Progressive

Select this when:

- your TV accepts progressive signals, and,
- the TV is connected to the COMPONENT VIDEO OUT jacks.

Note that the pictures will not be clear or no picture will appear if you select progressive signal output when either of the above conditions is not met.

◆ Interlace

Set to this position when:

- your TV does not accept progressive signals, or,
- your TV is connected to jacks other than the COMPONENT VIDEO OUT jacks (LINE 2 OUT (VIDEO or S VIDEO)).

Hint

When you select progressive signal output, you can fine-tune the signal according to the type of software you are watching (page 80).

Step 4: Connecting the Audio Cords

Select one of the following patterns **A** or **B**, according to the input jack on your TV monitor, projector, or AV amplifier (receiver). This will enable you to listen to sound.

A Connecting to audio L/R input jacks

This connection will use your TV's or stereo amplifier's (receiver's) two speakers for sound. You can enjoy the following surround effects (page 60).

- TV: Dynamic, Wide, Night
- Stereo amplifier (receiver): Standard, Night

B Connecting to a digital audio input jack

If your AV amplifier (receiver) has a Dolby[®]*1 Digital, DTS[®]*2, or MPEG audio decoder and a digital input jack, use this connection. You can enjoy Dolby Digital (5.1ch), DTS (5.1ch), and MPEG audio (5.1ch) surround effects.

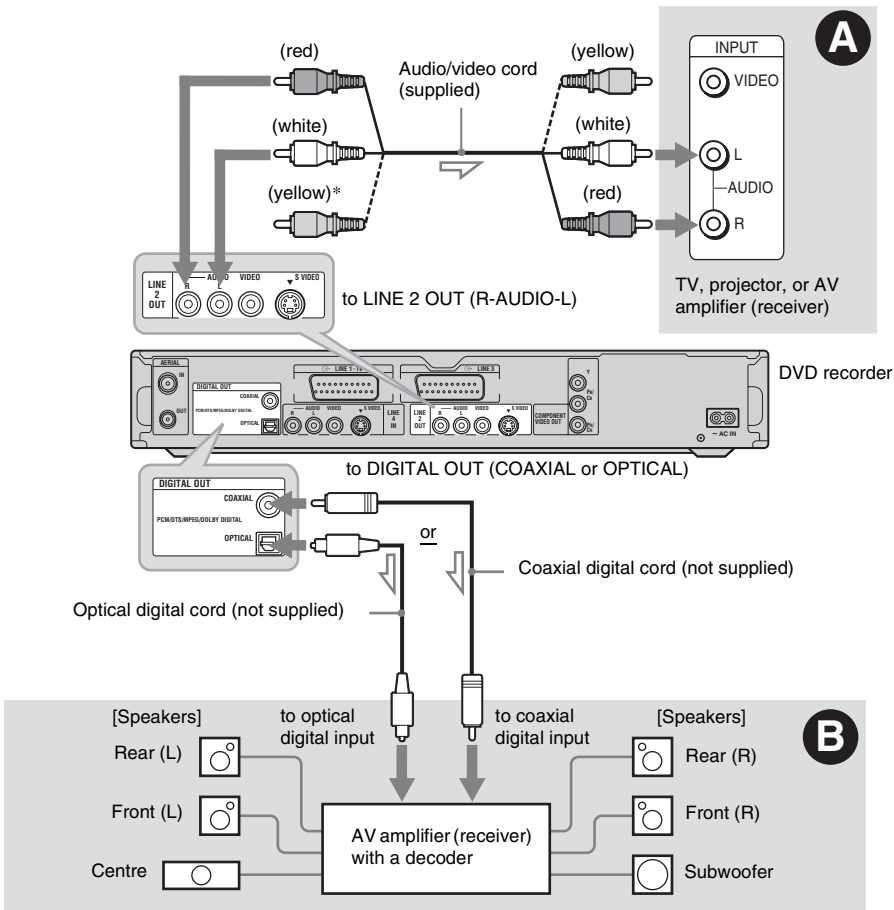

: Signal flow

* The yellow plug is used for video signals (page 14).

Hint

For correct speaker location, see the operating instructions supplied with the connected components.

Notes

- Do not connect your TV's audio output jacks to the LINE IN (R-AUDIO-L) jacks at the same time. This will cause unwanted noise to come from your TV's speakers.
- In the connection **A**, do not connect the LINE IN (R-AUDIO-L) and LINE 2 OUT (R-AUDIO-L) jacks to your TV's audio output jacks at the same time. This will cause unwanted noise to come from your TV's speakers.
- In the connection **B**, after you have completed the connection, make the appropriate settings under "Audio Connection" in "Easy Setup" (page 22). Otherwise, no sound or a loud noise will come from your speakers.
- With the connection **B**, the surround sound effects of this recorder cannot be used.

*1 Manufactured under license from Dolby Laboratories. "Dolby," and the double-D symbol are trademarks of Dolby Laboratories.

*2 "DTS" and "DTS Digital Out" are trademarks of Digital Theater Systems, Inc.

Step 5: Connecting the Mains Lead

Connect the supplied mains lead to the AC IN terminal of the recorder. Then plug the recorder and TV mains leads (power cords) into the mains. After you connect the mains lead, **you must wait for a short while before operating the recorder**. You can operate the recorder once the front panel display lights up and the recorder enters standby mode.

If you connect additional equipment to this recorder (page 23), be sure to connect the mains lead after all connections are complete.

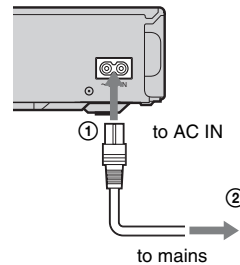

Step 6: Preparing the Remote

You can control the recorder using the supplied remote. Insert two R6 (size AA) batteries by matching the ⊕ and ⊖ ends on the batteries to the markings inside the battery compartment. When using the remote, point it at the remote sensor  on the recorder.

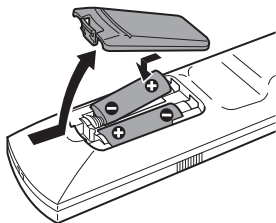

Notes

- If the supplied remote interferes your other Sony DVD recorder or player, change the command mode number for this recorder (page 21).
- Use the batteries correctly to avoid possible leakage and corrosion. Do not touch the liquid with bare hands should leakage occur. Observe the following:
 - Do not use a new battery with an old battery, or batteries of different manufacturers.
 - Do not attempt to recharge the batteries.
 - If you do not intend to use the remote for an extended period of time, remove the batteries.
 - If battery leakage occurs, wipe out any liquid inside the battery compartment, and insert new batteries.
- Do not expose the remote sensor (marked  on the front panel) to strong light, such as direct sunlight or lighting apparatus. The recorder may not respond to the remote.

Controlling TVs with the remote

You can adjust the remote's signal to control your TV.

If you connected the recorder to an AV amplifier (receiver), you can use the supplied remote to control the AV amplifier's (receiver's) volume.

Notes

- Depending on the connected unit, you may not be able to control your TV or AV amplifier (receiver) with some or all of the buttons below.
- If you enter a new code number, the code number previously entered will be erased.
- When you replace the batteries of the remote, the code number may be reset to the default setting. Set the appropriate code number again.

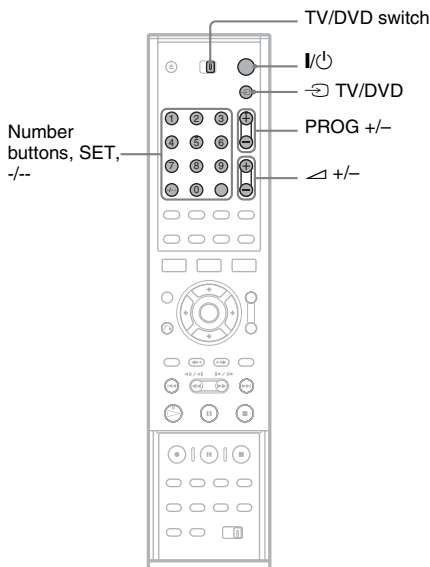

- 1 Slide the TV/DVD switch to TV.
- 2 Hold down I/Power.
- 3 Enter your TV's manufacturer code (see "Code numbers of controllable TVs" below) using the number buttons.

4 Release I/⏻.

When the TV/DVD switch is set to TV, the remote performs the following:

Buttons	Operations
I/⏻	Turns your TV on or off
◀ (volume) +/-	Adjusts the volume of your TV
PROG +/-	Selects the programme position on your TV
↺ TV/DVD	Switches your TV's input source
Number buttons and SET, -/--*	Selects the programme position on your TV

* If you use the number buttons to select the TV's programme position, press -/-- followed by the number buttons for two-digit numbers.

To operate the ↺ TV/DVD button (for SCART connections only)

When the TV/DVD switch is set to DVD, the ↺ TV/DVD button switches between the recorder and the last input source selected on the TV. Point your remote at the recorder when using this button.

When you connect the recorder to the TV via the SCART jacks, the input source for the TV is set to the recorder automatically when you start playback. To watch another source, press the ↺ TV/DVD button to switch the TV's input source.

Code numbers of controllable TVs

If more than one code number is listed, try entering them one at a time until you find the one that works with your TV.

Manufacturer	Code number
Sony	01 (default)
Aiwa	01 (default)
Grundig	11
Hitachi	23, 24, 72
Loewe	06, 45
Nokia	15, 16, 69, 73
Panasonic	17, 49
Philips	06, 07, 08, 23, 45, 72
Saba	12, 13, 36, 43, 74, 75

Manufacturer	Code number
Samsung	06, 22, 23, 71, 72
Sanyo	25
Sharp	29
Telefunken	12, 13, 36, 43, 74, 75
Thomson	12, 13, 43, 74, 75
Toshiba	38
LG	06
JVC	33

Controlling the volume of your AV amplifier (receiver) with the remote

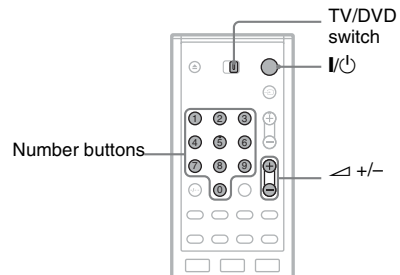

- 1 Slide the TV/DVD switch to DVD.
- 2 Hold down I/⏻, and enter the manufacturer code (see the table below) for your AV amplifier (receiver) using the number buttons.
- 3 Release I/⏻.

The ◀ (volume) +/- buttons control the AV amplifier's volume.

If you want to control the TV's volume, slide the TV/DVD switch to TV.

💡 Hint

If you want to control the TV's volume even when the TV/DVD switch is set to DVD, repeat the steps above and enter the code number 90 (default).

Code numbers of controllable AV amplifiers (receivers)

If more than one code number is listed, try entering them one at a time until you find the one that works with your AV amplifier (receiver).

Manufacturer	Code number
Sony	78, 79, 80, 91
Denon	84, 85, 86
Kenwood	92, 93
Onkyo	81, 82, 83
Pioneer	99
Sansui	87
Technics	97, 98
Yamaha	94, 95, 96

If you have a Sony DVD player or more than one Sony DVD recorder

If the supplied remote interferes with your other Sony DVD recorder or player, set the command mode number for this recorder and the supplied remote to one that differs from the other Sony DVD recorder or player.

The default command mode setting for this recorder and the supplied remote is DVD3.

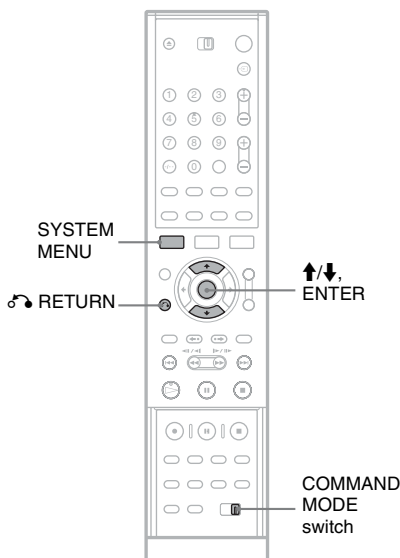

1 Press **SYSTEM MENU**.

The System Menu appears.

2 Select **"SETUP,"** and press **ENTER**.

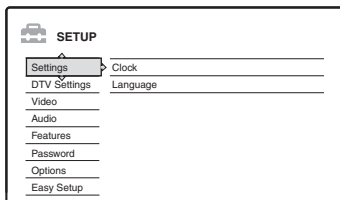

3 Select **"Options,"** and press **ENTER**.

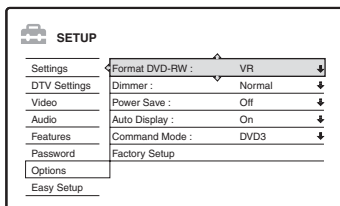

4 Select **"Command Mode,"** and press **ENTER**.

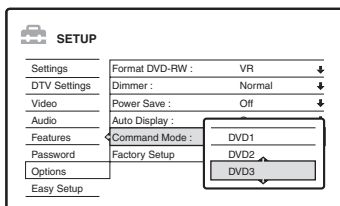

5 Select the Command mode (**DVD1, DVD2, or DVD3**), and press **ENTER**.

6 Slide the **COMMAND MODE** switch on the remote so it matches the mode you selected above.

To return to the previous step

Press **RETURN**.

Check that the command mode switch on the remote is set to the default setting of DVD3 before you try to change the command mode for the recorder. If the command mode for the remote is changed to DVD1 or DVD2, you may be unable to operate this recorder.

Step 7: Easy Setup

Make the basic adjustments by following the on-screen instructions in “Easy Setup.”

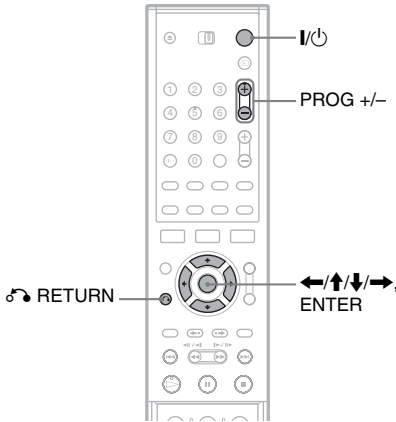

1 Turn on the recorder and switch the input selector on your TV so that the signal from the recorder appears on your TV screen.

The message about the initial settings appears.

- If this message does not appear, select “Easy Setup” from “SETUP” in the System Menu to run “Easy Setup” function (“Settings and Adjustments” on page 74).

2 Press ENTER.

Follow the on-screen instructions to make the following settings.

◆ Auto Tune

The recorder will automatically capture and store the available TV and Radio channels.

◆ Clock

The recorder will automatically search for a clock signal. If a clock signal cannot be found, set the clock manually using ←/↑/↓/→, and press ENTER.

◆ TV Type

If you have a wide-screen TV, select “16:9.”
If you have a standard TV, select either “4:3 Letter Box” (shrink to fit) or “4:3 Pan Scan” (stretch to fit). This will determine how “wide-screen” images are displayed on your TV.

◆ Component Out

If you are using the COMPONENT VIDEO OUT jack, select “On.”

◆ Line1 Output

To output video signals, select “Video.”

To output S video signals, select “S Video.”

To output RGB signals, select “RGB.”

Select “Video” to enjoy the SMARTLINK features.

- If you set “Component Out” to “On,” you cannot select “RGB.”

◆ Audio Connection

If you connected an AV amplifier (receiver) using either a digital optical or coaxial cord, select “Yes: DIGITAL OUT” and set the digital output signal (page 82).

3 Press ENTER when “Finish” appears.

“Easy Setup” is finished.

To return to the previous step

Press ↶ RETURN.

💡 Hints

- If your AV amplifier (receiver) has an MPEG audio decoder, set “MPEG” to “MPEG” (page 82).
- If you want to run “Easy Setup” again, select “Easy Setup” from “SETUP” in the System Menu (page 87).

Connecting a VCR or Similar Device

After disconnecting the recorder's mains lead from the mains, connect a VCR or similar recording device to the LINE IN jacks of this recorder.

See also the instruction manual supplied with the connected equipment.

To record on this recorder, see "Recording from connected equipment without a timer" on page 55.

Connecting to the LINE 3 jack

Connect a VCR or similar recording device to the LINE 3 jack of this recorder.

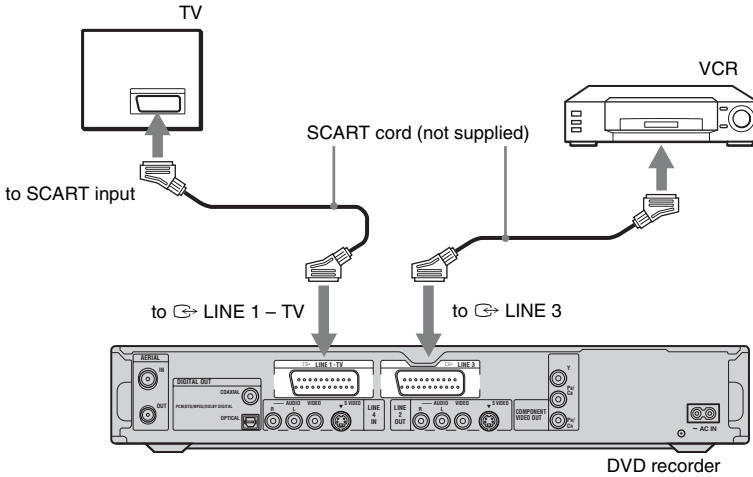

Notes

- Pictures containing copy protection signals that prohibit any copying cannot be recorded.
- If you pass the recorder signals via the VCR, you may not receive a clear image on your TV screen.

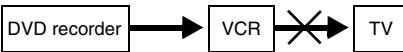

Be sure to connect your VCR to the DVD recorder and your TV in the order shown below. To watch video tapes, watch the tapes through a second line input on your TV.

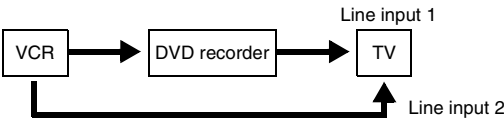

- The SMARTLINK features are not available for devices connected via the DVD recorder's LINE 3 jack.
- When you record to a VCR from this DVD recorder, do not switch the input source to TV by pressing the TV/VIDEO button on the remote.
- If you disconnect the recorder's mains lead, you will not be able to view the signals from the connected VCR.

Connecting to the LINE 2 IN or LINE 4 IN jacks

Connect a VCR or similar recording device to the LINE 2 IN or LINE 4 IN jacks of this recorder. If the equipment has an S-video jack, you can use an S-video cord instead of an audio/video cord.

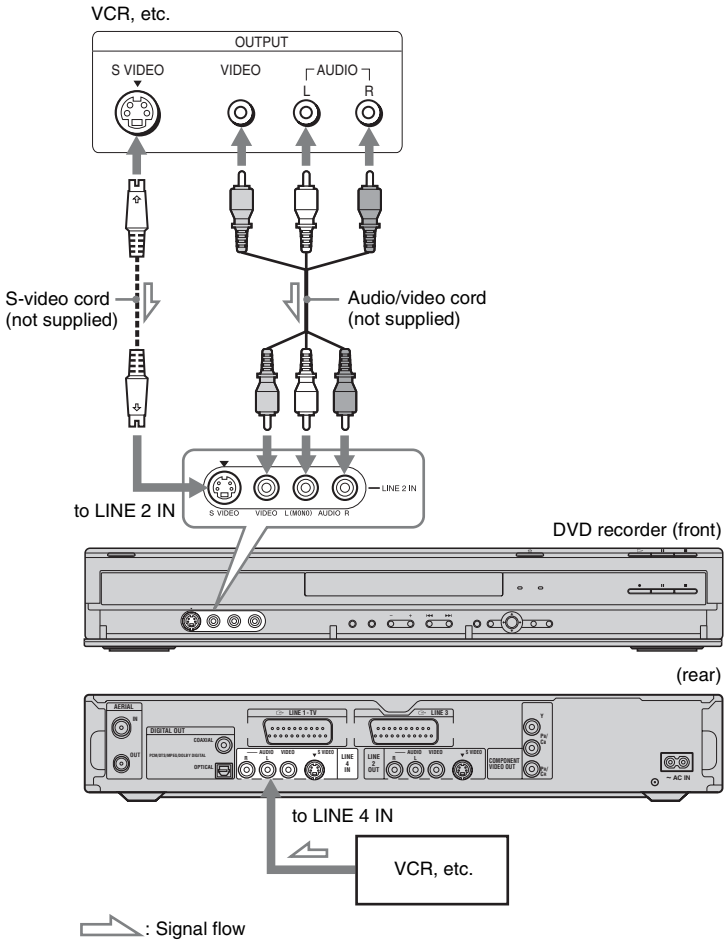

Hint

When the connected equipment outputs only monaural sound, connect only the L (MONO) and VIDEO input jacks on the front of the recorder. Do not connect the R input jack.

Notes

- Do not connect the yellow LINE IN (VIDEO) jack when using an S-video cord.
- Do not connect the output jack of this recorder to another equipment's input jack with the other equipment's output jack connected to the input jack of this recorder. Noise (feedback) may result.
- Do not connect more than one type of video cord between the recorder and your TV at the same time.

Connecting to a Satellite or Digital Tuner

Connect a satellite or digital tuner to this recorder using the LINE 3 jack. Disconnect the recorder's mains lead from the mains when connecting the tuner. To use the Synchro-Rec function, see below.

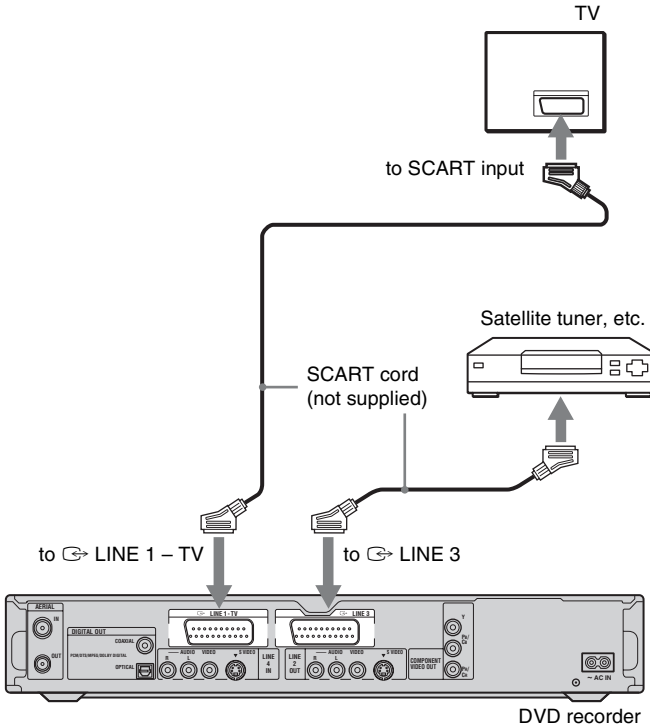

If the satellite tuner can output RGB signals

This recorder accepts RGB signals. If the satellite tuner can output RGB signals, connect the TV SCART connector on the satellite tuner to the LINE 3 jack, and set “Line3 Input” of “Scart Setting” to “Video/RGB” in “Video” setup (page 80). Note that this connection and setup disable the SMARTLINK function. If you want to use the SMARTLINK function with a compatible set top box, see the instructions supplied with the set top box.

If you want to use the Synchro Rec function

This connection is necessary to use the Synchro-Recording function. See “Recording from connected equipment with a timer (Synchro Rec)” on page 54.

Set “Line3 Input” of “Scart Setting” in “Video” setup (page 80) according to the specifications of your satellite tuner. See your satellite tuner’s instructions for more information.

If you are using a B Sky B tuner, be sure to connect the tuner’s VCR SCART jack to the LINE 3 jack. Then set “Line3 Input” of “Scart Setting” according to the specifications of the VCR SCART jack on your satellite tuner.

Notes

- Synchro-Recording does not work with some tuners. For details, see the tuner’s operating instructions.
- If you disconnect the recorder’s mains lead, you will not be able to view the signals from the connected tuner.

1. Inserting and Formatting a DVD Disc (Disc Info)

Inserting a Disc

+RW -RWVR -RW_{Video} +R -R DVD
VCD CD DATA DVD DATA CD

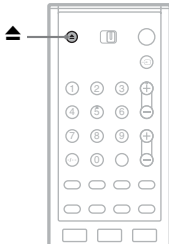

- 1 Press (open/close), and place a disc on the disc tray.

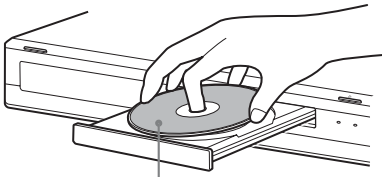

With the recording/playing side facing down

- 2 Press (open/close) to close the disc tray.

Wait until “LOAD” disappears from the front panel display.
Unused DVDs are formatted automatically.

Formatting a DVD disc (Disc Info)

+RW -RWVR -RW_{Video}

New discs are automatically formatted when inserted. If necessary, you can manually re-format a DVD+RW or DVD-RW disc to make a blank disc. For DVD-RWs, you can select a recording format (VR mode or Video mode) according to your needs (page 8).

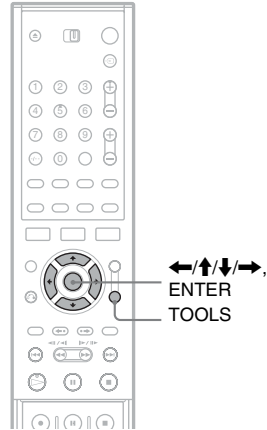

- 1 Insert a disc.
See “Inserting a Disc” on page 26.
- 2 Press **TOOLS**.
The **TOOLS** menu appears.

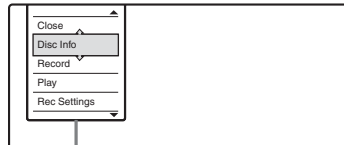

Options for the disc or picture

The **TOOLS** menu displays options applicable to the entire disc (e.g. disc protection), recorder (e.g. audio settings during recording), or multiple items on a list menu (e.g. erasing multiple titles). The displayed options differ depending on the situation and disc type.

3 Move the cursor down the TOOLS menu until “Disc Info” is selected, and press ENTER.

Example: When a DVD-RW (VR mode) is inserted.

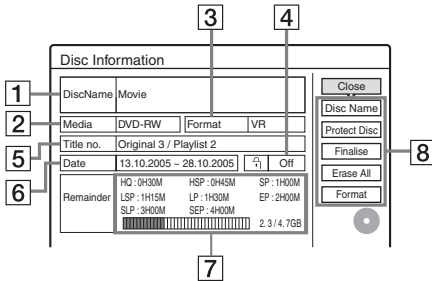

- 1 “Disc Name”
- 2 “Media”: Disc type
- 3 “Format”: Recording format type (DVD-RW only)
- 4 “On”/“Off”: Indicates whether protection is set (DVD-RW in VR mode only)
- 5 “Title no.”: Total number of titles
- 6 “Date”: Dates of when the oldest and the most recent titles were recorded
- 7 “Continuous Rem. Time”/“Remainder” (approximate)
 - The remaining recording time in each of the recording modes
 - Disc space bar
 - Remaining disc space/total disc space
- 8 Disc setting buttons
 - “Disc Name” (page 35)
 - “Protect Disc” (page 35)
 - “Finalise”/“Unfinalise” (page 36)
 - “Erase All” (page 70)
 - “Format”

Available settings differ depending on the disc type.

4 Select “Format,” and press ENTER.

5 Select “OK,” and press ENTER.

For DVD-RWs, select “VR” or “Video,” and press ENTER.

All contents on the disc are erased.

💡 Hints

- By reformatting, you can change the recording format on DVD-RWs, or record again on DVD-RWs that have been finalised.
- For DVD+RWs and DVD-RWs (Video mode), you can check free space and title location on the disc using the Disc Map display (page 70).

⚡ Note

On this model, 1 GB (read “gigabyte”) is equivalent to 1 billion bytes. The larger the number, the larger the disc space.

2. Recording a Programme

+RW -RW/VR -RW/video +R -R

This section introduces the basic operation to record the current TV programme to a disc (DVD). For an explanation of how to make timer recordings, see page 45.

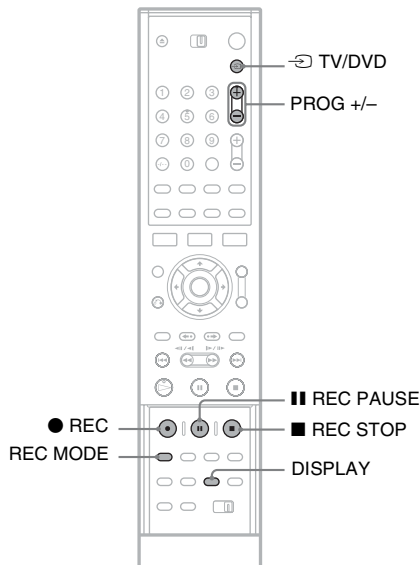

- 1 Insert a recordable DVD.**
See "Inserting a Disc" on page 26.
- 2 Press PROG +/- to select the programme position or input source you want to record.**
- 3 Press REC MODE repeatedly to select the recording mode.**

Each time you press the button, the display on the TV screen changes as follows:

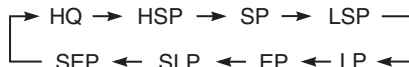

For more details about the recording mode, see page 45.

4 Press ● REC.

Recording starts.

Recording stops automatically after 8 hours of continuous recording or when the DVD is full.

To stop recording

Press ■ REC STOP located beneath the remote control cover.

Note that it may take a few seconds for recorder to stop recording.

To pause recording

Press || REC PAUSE located beneath the remote control cover.

To restart recording, press the button again.

To watch another TV programme while recording

If your TV is connected to the LINE 1 – TV jack, set your TV to the TV input using the ⇄ TV/DVD button and select the programme you want to watch. If your TV is connected to the LINE OUT or COMPONENT VIDEO OUT jacks, set the TV to TV input using the ⇄ TV/DVD button (page 19).

TV Direct Rec

If you use the SMARTLINK connection, you can easily record what you are watching on your TV. When the TV is turned on or in standby mode, press ● REC. The recorder automatically turns on and starts recording what you are watching on the TV.

Hint

If you do not want to watch TV while recording, you can turn off the TV.

Notes

- If "TV" appears in the front panel display, you cannot turn off the TV or change the programme position during TV Direct Rec. To turn off the function, set "TV Direct Rec" to "Off" in "Features" setup (page 83).
- After pressing ● REC, it may take a short while to start recording.
- You cannot change the recording mode while recording or during recording pause.
- If there is a power failure, the programme you are recording may be erased.
- To use the TV Direct Rec function, you must first set the recorder's clock correctly.

Checking the disc status while recording

You can check the recording information such as recording time or disc type.

Press DISPLAY twice during recording.

The recording information appears.

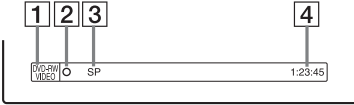

- 1 Disc type/format
- 2 Recording status
- 3 Recording mode
- 4 Recording time

Press DISPLAY to turn off the display.

3. Playing the Recorded Programme (Title List)



To play a recorded title, select the title from the Title List.

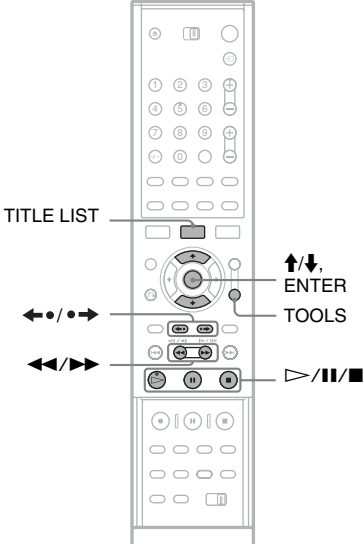

- 1 **Insert a DVD.**
See “Inserting a Disc” on page 26. Playback starts automatically depending on the disc.
- 2 **Press TITLE LIST.**
To show the extended Title List, press TOOLS to select “Display List,” and press ENTER.

Title List with Thumbnail Images (Example: DVD-RW in VR mode)

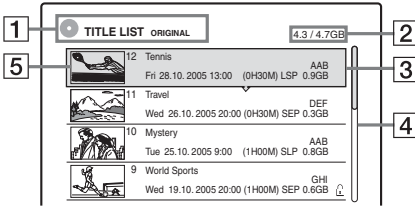

Extended Title List

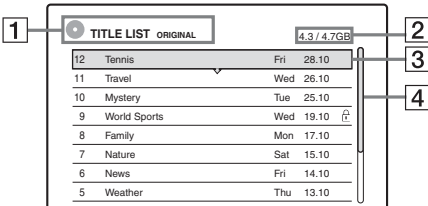

3 Select a title, and press ENTER.

The sub-menu appears.

The sub-menu displays options applicable only to selected item. The displayed options differ depending on the model, situation, and disc type.

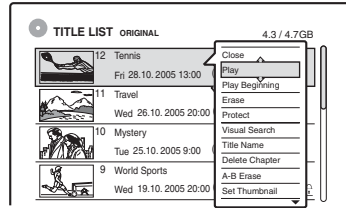

Sub-menu

4 Select "Play," and press ENTER.

Playback starts from the selected title.

1 Disc type:
Displays the title type (Original or Playlist) for DVD-RWs (VR mode).

2 Disc space (remainder/total)

3 Title information:
Displays the title number, title name, and recording date. Title size is shown in the Thumbnail title list.
● (red): Indicates that the title is currently being recorded.
⏏: Indicates the protected title.

4 Scroll bar:
Appears when all of the titles do not fit on the list. To view the hidden titles, press **↑/↓**.

5 Title's thumbnail picture
The still images for each title are displayed.

To stop playback

Press **■**.

To scroll the list display by page (Page mode)

Press **←•/•→** while the list display is turned on. Each time you press **←•/•→**, the entire Title List changes to the previous/next page of titles.

About the Title List for DVD-RWs (VR mode)

You can switch the Title List to show Original or Playlist.

While the Title List menu is turned on, press **TOOLS** to select either "Original" or "Playlist," and press **ENTER**.

For details, see "Edit options for DVD-RWs (VR mode)" on page 67.

To change the title order (Sort)

While the Title List menu is turned on, press **TOOLS** to select "Sort Titles." Press **↑/↓** to select the item, and press **ENTER**.

Order	Sorted
By Date	in order of when the titles were recorded. The title that is recorded most recently is listed at the top.
By Title	in alphabetical order.
By Number	in order of recorded title number.

To change a title thumbnail picture (Thumbnail) (DVD-RW in VR mode only)

You can select a favourite scene for the thumbnail picture shown in the Title List menu.

- 1 Press TITLE LIST in stop mode.
- 2 Select a title whose thumbnail picture you want to change, and press ENTER. The sub-menu appears.
- 3 Select “Set Thumbnail,” and press ENTER. The selected title starts to play in the background.
- 4 While watching the playback picture, press , , or to select the scene you want to set for a thumbnail picture, and press ENTER. The display asks for confirmation.
- 5 Select “OK,” and press ENTER. The scene is set for the title’s thumbnail picture.

To turn off the Title List

Press TITLE LIST.

Hints

- After recording, the first scene of the recording (the title) is automatically set as the thumbnail picture.
- You can select “TITLE LIST” from the System Menu.

Notes

- The title names may not appear for DVDs created on other DVD recorders.
- The letters that cannot be displayed are replaced with “*.”
- It may take a few seconds for the thumbnail pictures to be displayed.
- After editing, the title thumbnail picture may change to the first scene of the recording (title).

4. Displaying the Playing Time and Play Information



You can check the playing time and remaining time of the current title, chapter, or track. Also, you can check the disc name recorded on the DVD/CD.

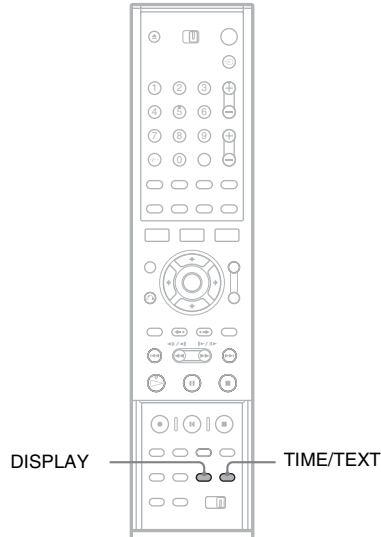

Press DISPLAY repeatedly.

Each time you press the button, the display changes as follows:

Display 1 → Display 2 → Display off

The displays differ depending on the disc type or playing status.

◆ Display 1

Example: When playing a DVD VIDEO

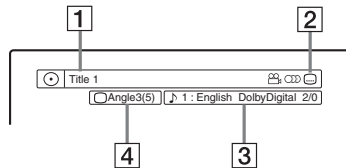

- 1 Title number/name
(Shows either track number, track name, scene number, or file name for CDs, VIDEO CDs, DATA DVDs, or DATA CDs.)

- 2 Available functions for DVD VIDEOS (angle/ audio/ subtitle, etc.), or playback data for DATA DVDs and DATA CDs

- 3 The current selected function or audio setting (appears only temporarily)

Example: Dolby Digital 5.1 ch
Rear (L/R)

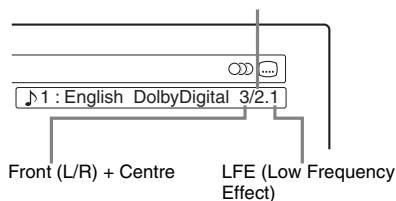

- 4 The current selected angle

◆ Display 2

Example: When playing a DVD-RW (VR mode)

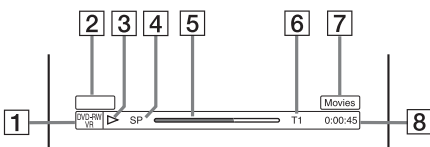

- 1 Disc type^{*1}/format (page 38)
- 2 Title type (only appears for Playlists) (page 67)
- 3 Play mode
- 4 Recording mode (page 45)
- 5 Playing status bar^{*2}
- 6 Title number (chapter number^{*3}) (page 62) (Shows either track number, scene number, album number^{*3}, or file number for CDs, VIDEO CDs, DATA DVDs, or DATA CDs.)
- 7 Album name appears for CDs with CD text, DATA DVDs or DATA CDs when you press TIME/TEXT repeatedly.
- 8 Playing time (remaining time^{*3})

^{*1} Displays Super VIDEO CDs as “SVCD,” DATA CDs as “CD” and DATA DVDs as “DVD.”

^{*2} Does not appear with VIDEO CDs, DATA DVDs, and DATA CDs.

^{*3} Displayed when you press TIME/TEXT repeatedly.

💡 Hints

- If “DTS” is set to “Off” in “Audio” setup, the DTS track selection option will not appear on the screen even if the disc contains DTS tracks (page 82).
- When “Auto Display” is set to “On” (default) in “Options” setup (page 86), playback information automatically appears when the recorder is turned on, etc.

🔍 Note

The letters or symbols that cannot be displayed are replaced with “*.”

Checking the playing/remaining time

You can view the playing or time information displayed on the TV screen and the front panel display.

Press TIME/TEXT repeatedly.

The displays differ depending on the disc type or playing status.

◆ Front panel display

Example: When playing a DVD

Playing time and number of the current title

T1 1:03:24

Remaining time of the current title

T1 - 1:15:36

Playing time and number of the current chapter

C2 0:22:30

Remaining time of the current chapter

C2 - 0:13:20

Example: When playing a VIDEO CD

Playing time and number of the current scene or track



Example: When playing a CD

Track playing time and the current track/index number

Remaining time of the current track

Playing time of the disc

Remaining time of the disc

CD text (when available)

Example: When playing an MP3 audio track

Playing time and number of the current track

Current album number

Example: When viewing a JPEG image

Current file number and total number of files in the current album

Current album number and total number of albums

Notes

- The recorder can only display the first level of a CD's text, such as the disc name.
- The letters or symbols that cannot be displayed are replaced with "*".
- Playing time of MP3 audio tracks may not be displayed correctly.

5. Changing the Name of a Recorded Programme

You can label a DVD, title, or program by entering characters. You can enter up to 64 characters for a title or disc name, but the actual number of characters displayed in the menus such as the Title List will vary. The steps below explain how to change the name of the recorded programme.

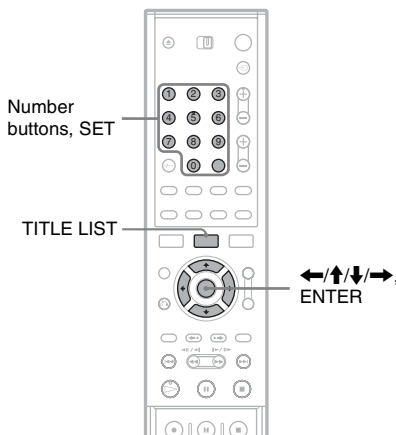

- 1 Press TITLE LIST.**
- 2 Select a title, and press ENTER.**
The sub-menu appears.
- 3 Select "Title Name," and press ENTER.**
The display for entering characters appears.
- 4 Press ←/↑/↓/→ to move the cursor to the right of the screen and select "A" (upper-case), "a" (lower-case), or "Symbol," and press ENTER.**
The characters of the selected type are displayed.

5 Press ←/↑/↓/→ to select the character you want to enter, and press ENTER.

The selected character appears at the top of the display.

Example: Input Title Name

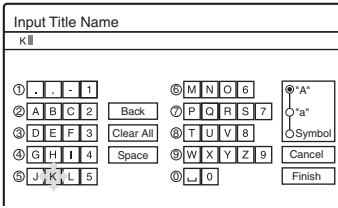

6 Repeat steps 4 and 5 to enter the remaining characters.

Input row

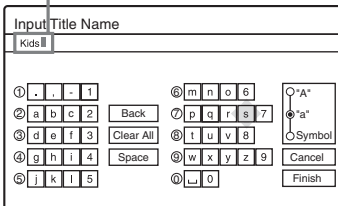

To erase a character, move the cursor to the right of the character at the input row. Select “Back” and press ENTER.

To insert a character, move the cursor to the right of the point where you want to insert the character. Select the character and press ENTER.

To erase all of the characters, select “Clear All” and press ENTER.

7 Select “Finish,” and press ENTER.

To cancel the setting, select “Cancel.”

To use the number buttons

You can also use the number buttons to enter characters.

1 In step 5 above, press a number button repeatedly to select a character.

Example:

Press the number 3 button once to enter “D.”

Press the number 3 button three times to enter “F.”

2 Press SET and select the next character.

3 Select “Finish” and press ENTER.

Hints

- You can erase all displayed characters by pressing and holding CLEAR for 2 seconds or more.
- You can switch between “A” (upper-case), “a” (lower-case), or “Symbol” even if you press INPUT SELECT.

6. Labelling and Protecting a Disc

You can execute options effective for the entire disc using the Disc Information display.

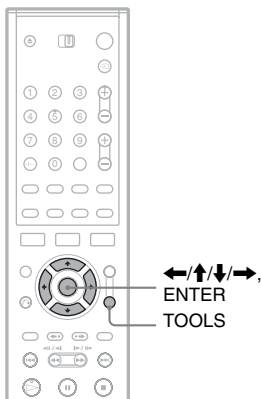

Labelling a disc

+RW **-RWVR** **-RWVideo** **+R** **-R**

- 1 Insert a disc.**
See “Inserting a Disc” on page 26.
- 2 Press TOOLS to select “Disc Info,” and press ENTER.**
Example: When the inserted disc is a DVD-RW (VR mode).

Disc Information			
DiscName			
Media	DVD-RW	Format	VR
Title no.	Original 3 / Playlist 2		
Date	13.10.2005 - 28.10.2005	Off	Off
Remainder	HQ: 0H30M	HSP: 0H45M	SP: 1H00M
	LSP: 1H15M	LP: 1H30M	EP: 2H00M
	SLP: 3H00M	SEP: 4H00M	
	2.3 / 4.7GB		

- 3 Select “Disc Name,” and press ENTER.**
Enter the disc name in the “Input Disc Name” display (page 33).

Note

You can enter up to 64 characters for a DVD's disc name. The disc name may not appear when the disc is played on other DVD equipment.

Protecting a disc

-RWVR

- 1 Insert a disc.**
See “Inserting a Disc” on page 26.
- 2 Press TOOLS to select “Disc Info,” and press ENTER.**
- 3 Select “Protect Disc,” and press ENTER.**
- 4 Select “Protect,” and press ENTER.**

Disc Information			
DiscName			
Media	DVD-RW	Format	VR
Title no.	Original 3 / Playlist 2		
Date	13.10.2005 - 28.10.2005	Off	Off
Remainder	HQ: 0H30M	HSP: 0H45M	SP: 1H00M
	LSP: 1H15M	LP: 1H30M	EP: 2H00M
	SLP: 3H00M	SEP: 4H00M	
	2.3 / 4.7GB		

To cancel the protection

Select “Don't Protect” in step 4.

Hint

You can set protection for individual titles (page 68).

7. Playing the Disc on Other DVD Equipment (Finalise)

+RW **-RWVR** **-RWVideo** **+R** **-R**

Finalising is necessary when you play discs recorded with this recorder on other DVD equipment.

When you finalise a DVD+RW, DVD-RW (Video mode), DVD+R, or DVD-R, a DVD menu will be automatically created, which can be displayed on other DVD equipment.

Before finalising, check the differences between the disc types in the table below.

Differences between the disc types

+RW Discs are automatically finalised when removed from the recorder. However, you may need to finalise the disc for certain DVD equipment, or if the recording time is short. You can edit or record on the disc even after finalising.

-RWVR Finalising is unnecessary when playing a disc on VR format compatible equipment. Even if your other DVD equipment is VR format compatible, you may need to finalise the disc, especially if the recording time is short. You can edit or record on the disc even after finalising.

-RWVideo Finalising is necessary when playing on any equipment other than this recorder. After finalising, you cannot edit or record on the disc. If you want to record on it again, unfinalise or reformat the disc (page 26). However, if you reformat the disc, all recorded contents will be erased.

+R Finalising is necessary when playing on any equipment other than this recorder.

-R After finalising, you cannot edit or record on the disc.

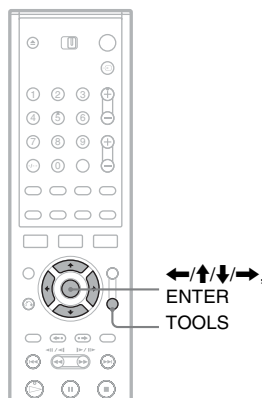

1 Insert a disc.

See “Inserting a Disc” on page 26.

2 Press TOOLS to select “Disc Info,” and press ENTER.

The “Disc Information” display appears.

3 Select “Finalise,” and press ENTER.

The display shows the approximate time required for finalising and asks for confirmation.

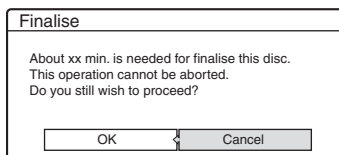

4 Select “OK,” and press ENTER.

The recorder starts finalising the disc.

💡 Hint

You can check whether the disc has been finalised or not. If you cannot select “Finalise” in step 3 above, the disc has already been finalised.

📌 Notes

- Depending on the condition of the disc, recording, or the DVD equipment, discs may not play even if the discs are finalised.
- The recorder may not be able to finalise the disc if it was recorded on another recorder.

Unfinalising a disc

-RWVR **-RW_{video}**

For DVD-RWs (Video mode)

DVD-RW (Video mode) that have been finalised to prohibit additional recording or editing can be unfinalised to allow further recording or editing.

For DVD-RWs (VR mode)

If you cannot record or edit on a DVD-RW (VR mode) that has been finalised with other DVD equipment, “This disc was finalised. Unfinalise it.” may appear.

Note

The recorder is not able to unfinalise DVD-RWs (Video mode) that have been finalised on another recorder.

1 Insert a disc.

See “Inserting a Disc” on page 26.

2 Press **TOOLS** to select “Disc Info,” and press **ENTER**.

The “Disc Information” display appears.

3 Select “Unfinalise,” and press **ENTER**.

The recorder starts unfinalising the disc. Unfinalising may take several minutes.

Note

Digital Services availability depends on the broadcaster. Digital Services are not instantly available when the recorder is first turned on.

EPG (Electronic Programme Guide)

The EPG provides a quick and easy way to:

- View a complete list of all available channels.
- View a channel list related to a chosen category.
- Set a programme to be recorded (page 48).

Viewing a list of available channels

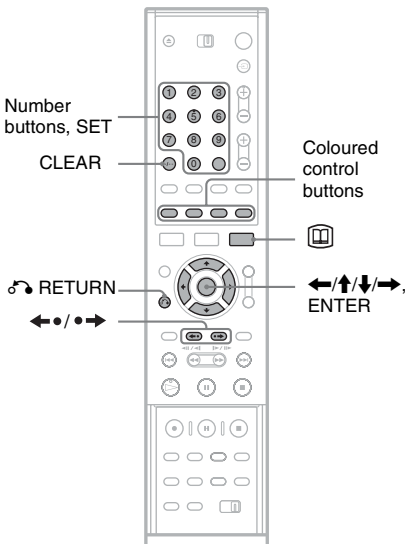



1 Press the  button to display the EPG.

This display consists of an information box and a ten channel programme list covering a two hour period.

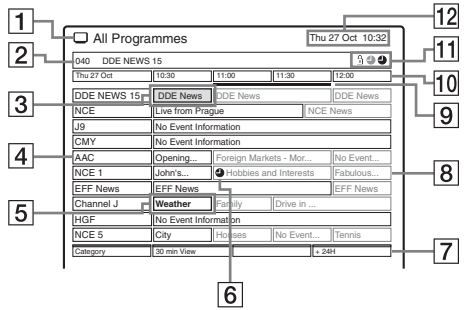
Example of EPG Display:



- 1 Indicates the TV or Radio mode. The Radio mode is indicated by a Radio icon 
- 2 Indicates the Local Channel Number and the Channel name of the programme that is currently highlighted in the list
- 3 Indicates the currently highlighted programme and allows you to move around the list
- 4 Channel name
- 5 Indicates the currently viewed programme
- 6 Indicates if a timer recording is associated with the event (page 48)
- 7 Coloured Control buttons
- 8 Truncated programme title in case the name is too long to be displayed in the cell
- 9 Event bar (e.g. Indicates a timer recording has been set during this time)
- 10 Time slot
- 11 Icon tray. Depending on the channel and programme settings some icons may appear in the display:
 : Either the channel or the programme is locked (page 75)
 : Timer event icons (page 49)
- 12 Indicates the current time and date

◆ **Some examples of category types are as follows:**

All Programmes: This gives a complete channel list.

Favourite List 1: Displays the favourite channels you have stored in the Favourite list 1 folder (page 42).

Films: Displays movies available for viewing.

News: Displays all news channels.

Entertainment: Displays all entertainment channels.

Sports: Displays all sports channels.

Kids: Displays all children's channels.

Music: Displays all music channels.

4 Press the **↑/↓** buttons to highlight a current time broadcasted programme you wish to view, then press the **ENTER** button.

The sub menu appears with the description of the programme displayed in the information box.

5 Select "View Channel," and press **ENTER** to view the programme.

To scroll the Category display by page (Page mode)

Press **←/→** while the Category display is turned on to change to the previous/next Category page.

Hint

In Step 4 above, the EPG application also allows you to set a timer recording, see page 48 for more details.

Programme information

The programme information display provides a quick and easy way to:

- View descriptions of the programmes being broadcast now and next on the current channel.
- View descriptions of the programmes being broadcast now and next on the other channels.
- Switch between TV and RADIO channels.

Displaying the programme information

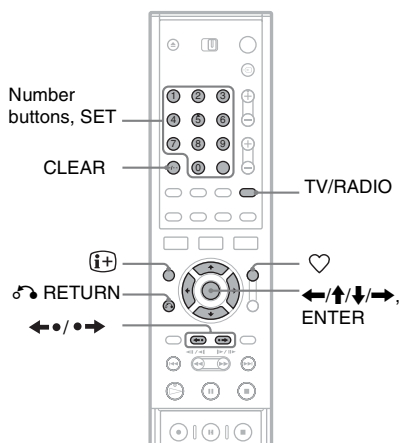

1 Press the **i+** button to display the programme information screen.

The Information display appears showing a description of the current programme on view.

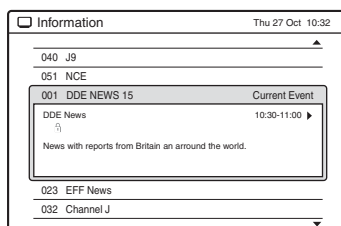

2 Press the **←/→** buttons to toggle the display between a description of the current programme and the next programme on that channel.

- 3 Press the **↑/↓** buttons or enter a channel number using the number buttons to display programme information on other channels.
- 4 Press the **TV/RADIO** button to switch between the TV and Radio channels
- 5 When viewing information for the currently highlighted channel, press the **ENTER** button to exit the information display and view the programme.

To scroll the Information display by page (Page mode)

Press **←•/•→** while the Information display is turned on to change to the previous/next page.

Hint

Press **♥** while the Information screen is turned on to toggle only the channels registered in the latest displayed Favourite List, see “Moving to a different favourite list” on page 43.

Viewing a digital text service

Many digital TV channels broadcast information via their text service. This digital service includes high quality digital text and graphics along with advanced navigation options. Additionally, this recorder has access to dedicated text channels transmitted by the broadcasters.

Note

The appearance, content and navigation methods of all digital text services are decided by the broadcaster.

Selecting digital text from dedicated digital teletext channels

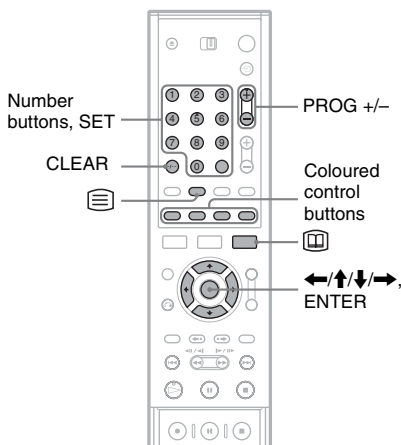





- 1 **Select a dedicated channel that is broadcasting digital text.**
If you do not know the number of a dedicated digital text channel, you can use the ‘Electronic Programme Guide’ by pressing the **☰** button to find one (page 38).
- 2 **Once the text page is displayed (this may take some time), follow the on-screen instructions to obtain your required selection.**
On some pages the TV programme may also be displayed on the text screen. On-screen instructions will inform you how to change the displayed programme.

- 3** If you are instructed to press 'OK' or 'Select' when viewing the text pages, press the ENTER button.
- 4** When you have finished viewing the text service, follow the on screen instructions, or press the PROG +/- button to exit.

Selecting digital text from other channels

Digital text services may also be available on other digital channels. This is sometimes indicated by a small symbol on your TV screen, superimposed on the programme you are watching.

- 1** Select a channel.
- 2** Press the  (Text) button or RED button or the button indicated on screen by the broadcaster.
- 3** Once the text information is displayed, you can access required information by using the , , ,  buttons, the coloured buttons and/or the numbered buttons on the remote control.

If you are instructed to press 'OK' or 'Select' when viewing the text pages, press the ENTER button on your remote control.

- 4** When you have finished viewing the text service displays, follow the on screen instructions, or press the PROG +/- button to exit.

Favourites

The Favourite application gives you the option to:

- Store your favourite channels into one of four TV or four Radio lists.
- Add or delete channels to the Favourites List.
- Quickly display a favourite channel on screen.

Setting a favourite list

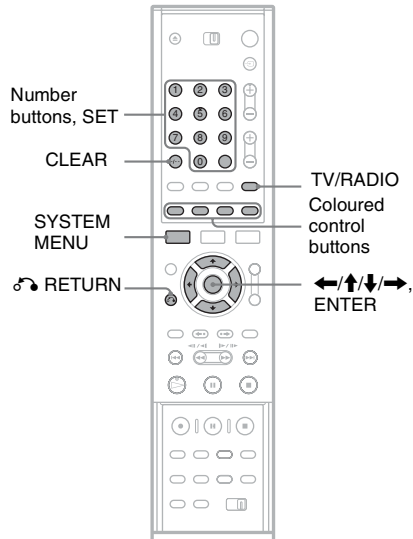

- 1** Press **SYSTEM MENU**.
The System Menu Display appears.
- 2** Select "**SETUP,**" and press **ENTER**.
The Setup Display appears.
- 3** Select "**DTV Settings,**" and press **ENTER**.

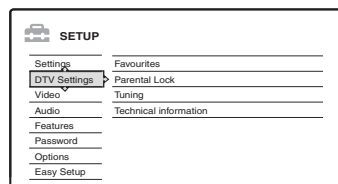

4 Select "Favourites," and press ENTER

The DTV Settings- Favourites List 1 display appears.

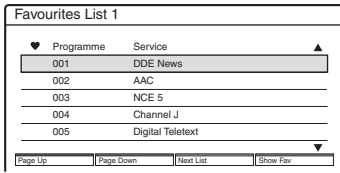

This display shows all the TV or Radio channels available to you.

5 Press the TV/RADIO button to display either your favourite TV or favourite Radio channels at any time.

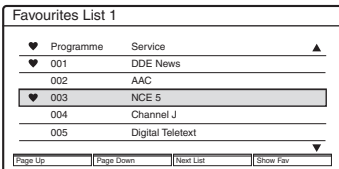

The Radio mode is indicated by the presence of a Radio icon  in the Favourite List panel.

6 Press the \uparrow/\downarrow buttons or enter a channel number to highlight a channel you want to add as a favourite, then press the ENTER button.



If you do not wish to choose from one of the five channels in the display, press the RED or GREEN button to view the previous or next five channels available.

Deleting a favourite channel

A channel selected as a favourite is identified by an  icon next to the programme number. In Step 6 above press the \uparrow/\downarrow buttons to highlight the channel you want to delete from your Favourite List, then press ENTER: the  icon next to the programme number disappears.

Hints

- Press the BLUE button to view the list showing only your favourite channels.
- Press the BLUE button once again when you wish to return to the previous favourite channel setting display.

Moving to a different favourite list

1 While a Favourite List is displayed, press repeatedly the YELLOW button on the remote control until the favourite list you want to view is displayed.

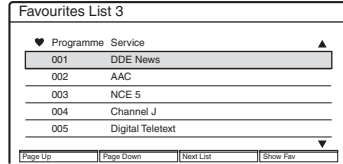

2 To add a channel to this new list, press the \uparrow/\downarrow buttons to highlight the channel you wish to add and press the ENTER button.

3 When you have stored all your favourite channels, press the RETURN button repeatedly to come back to normal operation.

Watching or listening to a favourite channel

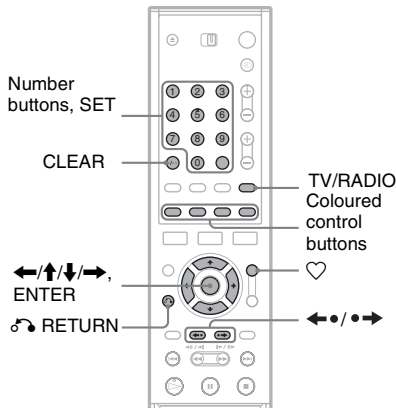

1 While in normal operation mode, press the button on the remote control.

A Favourite List display appears.

Indicates the currently viewed channel

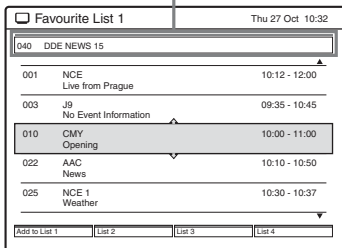

Each favourite list is represented by a coloured button.

- 2 Press the TV/RADIO button to display either your favourite TV or favourite Radio channels at any time.

The Radio mode is indicated by the presence of a Radio icon  in the Favourite List panel.

- 3 Press the coloured button on the remote control that represents the desired list to be displayed.
- 4 Press the  button to highlight the channel you wish to view or listen to, then press the ENTER button.

To scroll the Favourite List display by page (Page mode)

Press  while the Favourite List display is turned on to change to the previous/next page.

Hint

If you wish, the currently viewed channel can be added to the favourite list. Simply press the coloured button indicated in the display to add it to the list.

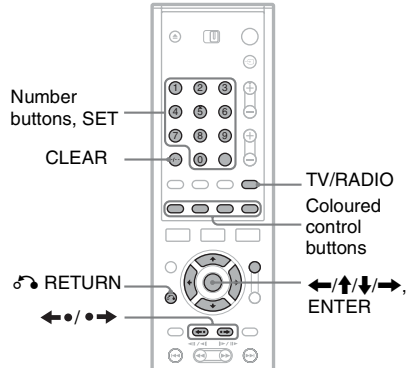

Index

The Index application is an easy way to display a scrollable list of all the tuned channels, including your favourites channel lists, and allows one of these to be selected.

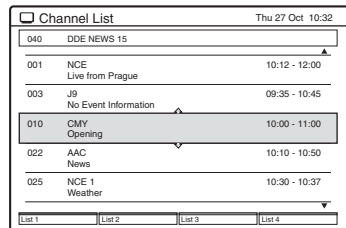

- 1 While in normal operation mode, press the ENTER button on the remote control. The Index display appears.



- 2 Press the TV/RADIO button to display either the TV or the Radio channels at any time. The Radio mode is indicated by the presence of a Radio icon  in the Index panel.
- 3 Press the coloured buttons on the remote control if you wish to display your Favourites Lists.
- 4 Press the  buttons to highlight the desired channel, then press the ENTER button to exit the index menu and view the selected channel.

To scroll the Index display by page (Page mode)

Press  while the Index display is turned on to change to the previous/next page.

Before Recording

Before you start recording...

- This recorder can record on various discs. Select the disc type according to your needs (page 8).
- Check that the disc has enough available space for the recording (page 26). For DVD+RWs, and DVD-RWs, you can free up disc space by erasing titles (page 70).
- Adjust the recording picture quality and picture size if necessary (page 50).

Hint

Timer recordings will be made regardless whether or not the recorder is turned on. You can turn off the recorder without affecting the recording even after recording starts.

Notes

- If any digital teletext is operated while recording, it's contents will be recorded on the disc.
- If the subtitles are displayed while recording, they will be recorded on the disc.
- To play a recorded disc on other DVD equipment, finalise the disc (page 36).

Recording mode

Like the SP or LP recording mode of VCRs, this recorder has eight different recording modes. Select a recording mode according to the time and picture quality you need. For example, if picture quality is your top priority, select the High Quality mode (HQ). If recording time is your priority, Super Extended Play mode (SEP) can be a possible choice. Note that recording times in the following table are approximate and the actual times may differ. Note also that the maximum continuous recording time for a single title is eight hours. Contents beyond this time will not be recorded.

Press REC MODE repeatedly to switch the recording modes.

Recording mode	Recording time (hours)	
	DVD	DVD+R DL*
HQ (High quality)	1	1 hr.48 min.
HSP ↑	1 hr.30 min.	2 hr.42 min.
SP (Standard mode)	2	3 hr.37 min.
LSP ↓	2 hr.30 min.	4 hr.31 min.
LP ↓	3	5 hr.25 min.
EP ↓	4	7 hr.14 min.
SLP ↓	6	10 hr.51 min.
SEP (Long duration)	8	14 hr.28 min.

* The recording time for DVD+R DL (Double Layer).

Note

Situations below may cause slight inaccuracies with the recording time.

- Recording a programme with poor reception, or a programme or video source of low picture quality
- Recording on a disc that has already been edited
- Recording only a still picture or just sound

Unrecordable pictures

Pictures with copy protection cannot be recorded on this recorder.

When the recorder receives a copy guard signal, the recorder continues to record but only a blank, grey coloured screen will be recorded.

Copy control signals	Recordable discs
Copy-Free	+RW -RWVR -RW _{Video} +R -R
Copy-Once	-RWVR (CPRM*)
Copy-Never	None (a blank screen is recorded)

* The recorded disc can be played only on CPRM compatible equipment (page 8).

Timer Recording (Standard/EPG)

+RW -RWVR -RWVideo +R -R

You can set the timer for a total of 30 programmes up to one month in advance.

There are two methods to set the timer: the standard method and EPG method.

- Standard: Set the date, time, and programme position of the programme manually.
- EPG: Set a programme to be recorded based on the information provided by the EPG (Electronic Programme Guide) (page 48). This method allows you to set the timer up to 8 days from the current time (depending on programme availability from the broadcaster).

Setting the timer manually (Standard)

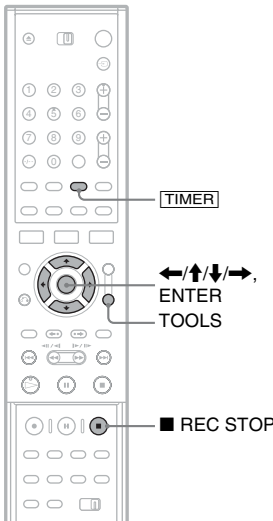

1 Press **TIMER**.

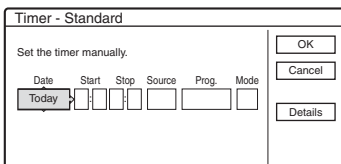

2 Select an item using **←/→** and adjust using **↑/↓**.

“Date”: Sets the date.

The item changes as follows:

Today ↔ Tomorrow ↔ ↔ Thu 28.10 (1 month later) ↔ Sun (every Sunday) ↔ ↔ Sat (every Saturday) ↔ Mon-Fri (Monday to Friday) ↔ Mon-Sat (Monday to Saturday) ↔ Sun-Sat (Sunday to Saturday) ↔ Today

“Start”: Sets the start time.

“Stop”: Sets the stop time.

“Source”: Selects the input source as follows: TV ↔ Line (External input) ↔ Radio ↔ TV

“Prog.”: Selects the TV/Radio programme position or input line.

“Mode”: Selects the recording mode (page 45).

- If you make a mistake, select the item and change the setting.

3 Select “OK,” and press **ENTER**.

The Timer List (page 52) appears. The **TIMER REC** indicator lights up on the front panel and the recorder is ready to start recording.

Unlike a VCR, there is no need to turn off the recorder before the timer recording starts.

To stop recording during timer recording

Open the remote’s cover and press **■ REC STOP**. Note that it may take a few seconds for the recorder to stop recording.

Rec Mode Adjust

If there is not enough available disc space for the recording, the recorder automatically adjusts the recording mode to enable the entire programme to be recorded. This function is normally set to “On.”

To cancel this function, press **TOOLS** while the Timer List is displayed. Select “Rec Mode Adjust” and press **ENTER**. Select “Off” and press **ENTER**.

If the timer settings overlap

Overlapped timer settings are shown as follows.

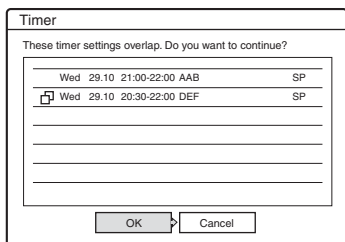

To store the setting as shown, select “OK.” The programme that starts first has priority and the second programme starts recording only after the first programme has finished (page 53). To cancel the overlapped setting, select “Cancel.”

To confirm, change, or cancel timer recording

See “Checking/Changing/Cancelling Timer Settings (Timer List)” on page 52.

To extend the recording duration time while recording

- 1 Press **TOOLS** during recording to select “Extend Rec.,” and press **ENTER**.

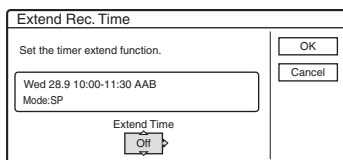

- 2 Press **↑/↓** to select the duration time. You can set the duration in increments of 10 minutes, for a maximum of 60 minutes.
- 3 Select “OK” and press **ENTER**.

One Touch Timer

If you use the SMARTLINK connection, you can easily display the timer programming menu. When the TV is turned on or in standby mode, press **[TIMER]**. The recorder automatically turns on and the TV’s input is switched to the recorder. The Timer programming menu appears.

Hint

You can play the recorded programme by selecting the programme title in the Title List.

Notes

- If a message indicating that the disc is full appears on the screen, change the disc, or make available space for the recording (DVD+RW/DVD-RW only) (page 70).
- Check that the clock is correctly set before setting the timer recording. If not, the timer recording cannot be made. To record a satellite programme, turn on the satellite tuner and select the satellite programme you want to record. Leave the satellite tuner turned on until the recorder finishes recording. If you connect equipment with a timer function, you can use the Synchro Rec function (page 54).
- Even if the timer is set for the same daily or weekly programme, the timer recording cannot be made if it overlaps with a programme that has priority. “” will appear next to the overlapped setting in the Timer List. Check the priority order of the settings.
- Even if the timer is set, timer recordings cannot be made while recording a programme that has priority.
- The Rec Mode Adjust function only works with a timer recording. It does not function with Quick Timer or Synchro Rec.

Recording TV programmes using the EPG application

The EPG application is a feature that simplifies setting the timer. Just select the programme you wish to record in the EPG display. The date, time, and channel of that programme are set automatically.

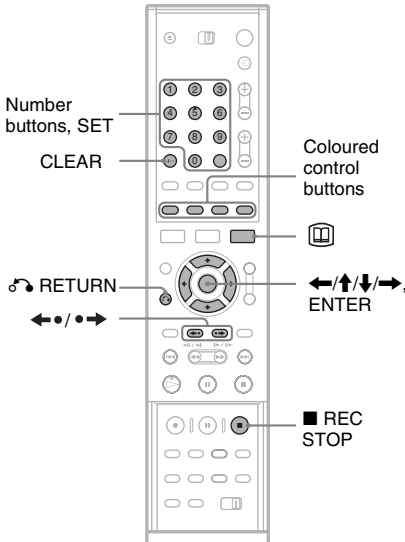

- 1 Insert a recordable disc.
- 2 Press the button to display the EPG.
- 3 Press the buttons or enter a channel number using the number buttons to move around the list.

All Programmes		Thu 27 Oct 10:32			
040	DDE NEWS 15	10:30	11:00	11:30	12:00
Thu 27 Oct					
DDE NEWS 15	DDE News	DDE News	DDE News	DDE News	
NCE	Live from Prague		NCE News		
J9	No Event Information				
CMY	No Event Information				
AAC	Opening...	Foreign Markets - Mor...		No Event...	
NCE 1	John's...	Hobbies and Interests		Fabulous...	
EFF News	EFF News			EFF News	
Channel J	Weather	Family	Drive in ...		
HGF	No Event Information				
NCE 5	City	Houses	No Event...	Tennis	
Category	30 min View		t. 24h		

To know more about the navigation options in the EPG application, see page 38.

- 4 Select a current time TV/radio broadcast or a future programme you wish to record. Once highlighted, press the ENTER button. The sub menu appears with the description of the programme displayed in the information box.

Event Action

Select an action for this event

Hobbies and Interests
Thu 27.10 11:00-12:00
NCE 1 SP 2.7GB
Today's Hint: How to make finger puppets.

Timer

View Channel

Modify

Erase

Check Overlap

Cancel

In case is displayed: Indicates that the programme is age limited (page 75).

- 5 Select "Timer," and press ENTER. The Timer setting confirmation display appears

Timer

Do you want to record this event?

Hobbies and Interests
Thu 27.10 11:00-12:00 NCE 1
Mode:SP

OK Cancel Modify

"Modify," allows you to adjust the timer setting, see page 52.

- 6 Select "OK," and press ENTER.
 - In case of a current TV/radio broadcast timer setting, your recorder will immediately start recording.
 - In case of a future programme timer setting, you can see that an event bar and a new icon appears in the EPG display indicating that a timer event is associated to that programme.

All Programmes		Thu 27 Oct 10:32			
040	DDE NEWS 15	10:30	11:00	11:30	12:00
Thu 27 Oct					
DDE NEWS 15	DDE News	DDE News	DDE News	DDE News	
NCE	Live from Prague		NCE News		
J9	No Event Information				
CMY	No Event Information				
AAC	Opening...	Foreign Markets - Mor...		No Event...	
NCE 1	John's...	Hobbies and Interests		Fabulous...	
EFF News	EFF News			EFF News	
Channel J	Weather	Family	Drive in ...		
HGF	No Event Information				
NCE 5	City	Houses	No Event...	Tennis	
Category	30 min View		t. 24h		

Your recorder will automatically begin recording when the programme starts.

◆ Some examples of timer event icon types are as follows:

- (red): Indicates the programme is set as timer and whole programme can be recorded.
- (grey): Indicates the programme is set as timer but only a part of the programme can be recorded. (e.g. because of timer setting overlap).
- (red): Indicates the programme is now recording.

To scroll the EPG display by page (Page mode)

Press ◀●/●▶ while the EPG display is turned on to display the previous/next ten channels.

To stop recording during timer recording

Open the remote's cover and press ■ REC STOP. Note that it may take a few seconds for the recorder to stop recording.

If the timer settings overlap

See page 47.

To confirm, change, or cancel timer recording

See "Checking/Changing/Cancelling Timer Settings (EPG)" (page 51).

💡 Hint

The Rec Mode Adjust function also works with this timer method (page 46).

🔌 Notes

- It is not possible to extend the recording duration time of the timer recording set using the EPG application timer setting.
- This recorder is featured with an EPG timer auto extend functionality that allows EPG timer recordings to be made in case of broadcast early start (before the scheduled start time) or broadcast late finishing (after the scheduled end time).
- The EPG programme start and end time are determined by the broadcaster.

Using the Quick Timer function

You can set the recorder to record in 30-minute increments.

Press ● REC repeatedly to set the duration.

Each press advances the time in 30-minute increments. The maximum duration is six hours.

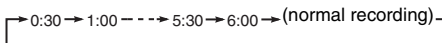

The time counter decreases minute by minute to 0:00, then the recorder stops recording (power does not turn off). Even if you turn off the recorder during recording, the recorder continues to record until the time counter runs out.

Note that the Quick Timer function does not work if "TV Direct Rec" is set to "On" in "Features" setup (page 83).

To cancel the Quick Timer

Press ● REC repeatedly until the counter appears in the front panel display. The recorder returns to normal recording mode.

Adjusting the recording picture quality and size

You can adjust the recording picture quality and picture size.

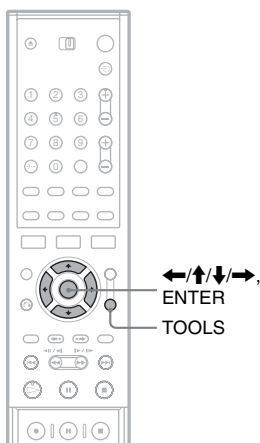

1 Before recording starts, press TOOLS to select “Rec Settings,” and press ENTER.

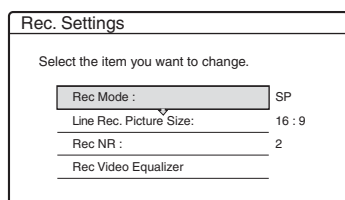

2 Select the item you want to adjust, and press ENTER.

The adjustment display appears.
Example: Rec NR

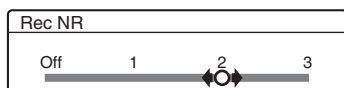

“Rec Mode”: Selects the recording mode for the desired recording time and picture quality. For more information, see “Recording mode” on page 45.

“Line Rec. Picture Size”: Sets the picture size of the programme to be recorded.

- 4:3: Sets the picture size to 4:3.
- 16:9 (default): Sets the picture size to 16:9 (wide mode).

This function works with DVD-Rs and DVD-RWs (Video mode) when the recording mode is set to HQ, HSP, SP, or LSP. For all other recording modes, the screen size is fixed at “4:3.”

For DVD-RWs (VR mode), the actual picture size is recorded regardless of the setting. For example, if a 16:9 size picture is received, the disc records the picture as 16:9 even if “Line Rec. Picture Size” is set to “4:3.”

For DVD+RWs/DVD+Rs, the screen size is fixed at “4:3.”

“Rec NR” (noise reduction): Reduces noise contained in the video signal.

“Rec Video Equalizer”: Adjusts the picture in greater detail.

Press \uparrow/\downarrow to select the item you want to adjust, then press ENTER.

- Contrast: Changes the contrast.
- Brightness: Changes the overall brightness.
- Colour: Makes the colours deeper or lighter.

3 Adjust the setting using $\leftarrow/\uparrow/\downarrow/\rightarrow$, and press ENTER.

The default setting is underlined.

“Rec NR”: (weak) Off 1 ~ 2 ~ 3 (strong)

“Rec Video Equalizer”:

- Contrast: (weak) -3 ~ 0 ~ 3 (strong)
- Brightness: (dark) -3 ~ 0 ~ 3 (bright)
- Colour: (light) -3 ~ 0 ~ 3 (deep)

Repeat steps 2 and 3 to adjust any other items.

Notes

- If one programme contains two picture sizes, the selected size is recorded. However, if the 16:9 signal cannot be recorded as 16:9, it is recorded as 4:3.
- Remnants of images may appear on your screen when using “Rec NR.”

Creating chapters in a title

The recorder can automatically divide a recording (a title) into chapters by inserting chapter marks during recording. To disable this function, set “Auto Chapter” in “Features” setup to “Off” (page 83).

When recording on a DVD-RW (VR mode)

The recorder detects changes in the picture and sound and automatically inserts chapter marks. You can also insert and erase chapter marks manually (page 71).

When recording on other recordable discs

Chapter marks are inserted at approximately 6-minute intervals during recording.

Checking/Changing/ Cancelling Timer Settings (EPG)

+RW -RWVR -RW_{Video} +R -R

You can check, change, or cancel timer settings using the EPG menu.

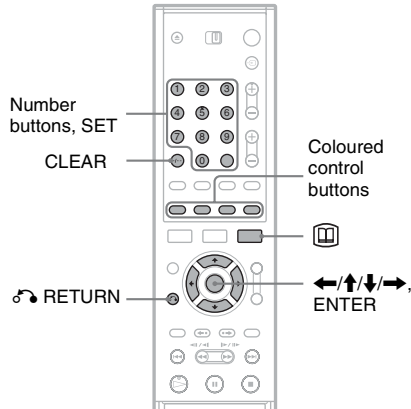

1 Press the button to display the EPG.

A timer setting can be identified thanks to the event bar and the timer event icon displayed in the EPG screen. For details, see page 48.

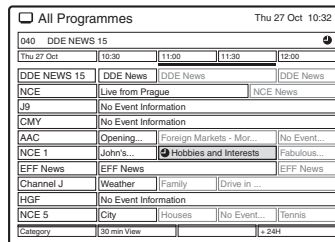

2 Press the /// buttons to select a future timer event you want to check/change/cancel. Once highlighted, press the ENTER button.

The Event Action menu appears.

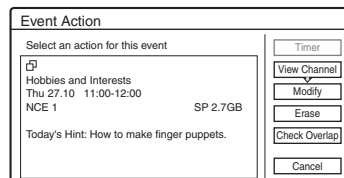

3 Press the **↑/↓** buttons to select the options. Once highlighted, press the **ENTER** button.

The sub menu appears:

“Modify”: Changes the timer setting. Select an item using **←/→** and adjust using **↑/↓**. Select “OK” and press **ENTER**.

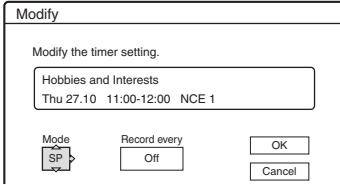

Note

If you set “Record every” to an other option than “Off”, then your EPG timer recording will be converted into a standard timer recording: the timer event icon disappears from the EPG display.

“Erase”: Erases the timer setting. Select “OK” and press **ENTER**.

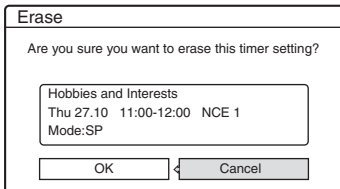

“Check Overlap”: Checks for overlapped settings.

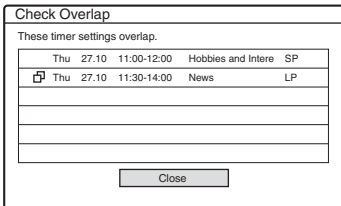

Select “Close” to return to the EPG screen. To change or cancel the setting, repeat steps 2 and 3 above.

Checking/Changing/ Cancelling Timer Settings (Timer List)



You can check, change, or cancel timer settings using the Timer List.

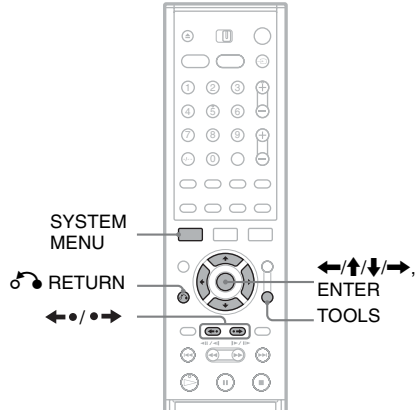

- 1 Press SYSTEM MENU.**
The System Menu appears.
- 2 Select “TIMER LIST,” and press ENTER.**
The Timer List appears.

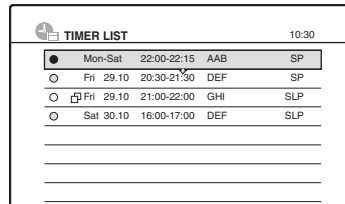

Timer information displays the recording date, time, recording mode, etc.

☐: Indicates that the setting is overlapped by another setting.

● (green): Indicates the setting can be recorded.

● (red): Indicates the setting currently being recorded.

○ (grey): Indicates that the setting cannot be recorded in the selected recording mode.

When all of the timer settings do not fit on the list, scroll bar appears.

To view the hidden timer settings, press **↑/↓**.

3 Select the timer setting you want to check/change/cancel, and press ENTER.

The sub-menu appears.

4 Select one of the options, and press ENTER.

“Modify”: Changes the timer setting.
Select an item using ←/→ and adjust using ↑/↓.

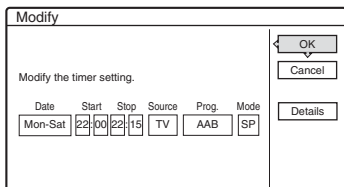

“Erase”: Erases the timer setting. Select “OK,” and press ENTER.

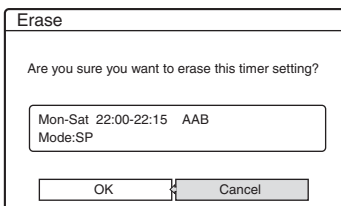

“Check Overlap”: Checks for overlapped settings.

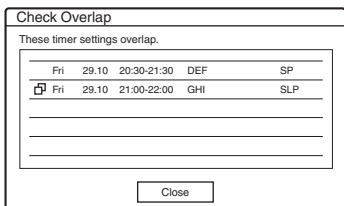

Select “Close” to return to the Timer List.

“Info”: Displays the timer setting information box along with the disc space required to record the whole programme (according to the selected recording mode).

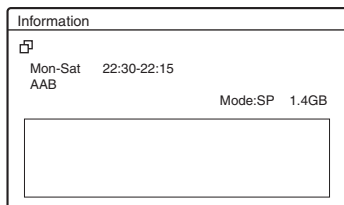

Press ↵ RETURN to come back to the Timer List.

To change or cancel the setting, repeat steps 3 and 4 above.

When the timer settings overlap

The programme that starts first has priority and the second programme starts recording only after the first programme has finished.

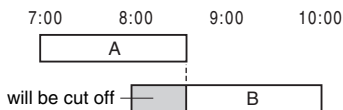

◆ When the recordings start at the same time

The programme that is set last has priority. In this example, timer setting B is set after A, so the first part of timer setting A will not be recorded.

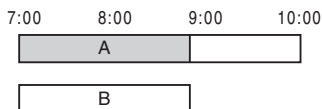

◆ When the end time of one recording and the start time of another are the same

After finishing the previous recording, the other recording may be delayed.

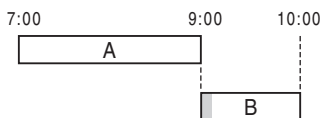

To scroll the list display by page (Page mode)

Press ←•/•→ while the list display is turned on. Each time you press ←•/•→, the entire Timer List changes to the previous/next page of timer settings.

To turn off the Timer List

Press TIMER LIST or ↵ RETURN.

💡 Hint

While recording, you cannot modify the timer setting for the current recording, but you can extend the recording duration of the recording time (page 47).

📌 Notes

- Even if the timer is set, timer recordings cannot be made while recording a programme that has priority.
- Even if the timer is set for the same daily or weekly programme, the timer recording cannot be made if it overlaps with a programme that has priority. “” will appear next to the overlapped setting in the Timer List. Check the priority order of the settings.

Recording From Connected Equipment

+RW -RWVR -RWVideo +R -R

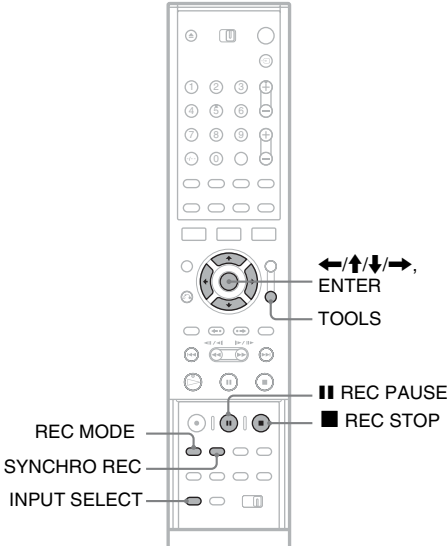

Recording from connected equipment with a timer (Synchro Rec)

You can set the recorder to automatically record programmes from connected equipment that has a timer function (such as a satellite tuner). Connect the equipment to the LINE 3 jack of the recorder (page 25).

When the connected equipment turns on, the recorder starts recording a programme from the LINE 3 jack.

- 1** Insert a recordable DVD.
See “Inserting a Disc” on page 26.
- 2** Press **INPUT SELECT** repeatedly to select “L3” in the front panel display.

- 3** Select the line input audio when recording a bilingual programme on the DVD-RWs (VR mode).

Press **TOOLS** to select “Line Audio Input,” and press **ENTER**. Then select “Bilingual,” and press **ENTER**.

- 4** Press **REC MODE** repeatedly to select the recording mode.

For details about the recording mode, see page 45.

- 5** Set the timer on the connected equipment to the time of the programme you want to record, and turn it off.

- 6** Press **SYNCHRO REC**.

The **SYNCHRO REC** indicator lights up on the front panel. The recorder is ready to start Synchro-Recording.

The recorder automatically starts recording when it receives an input signal from the connected equipment. The recorder stops recording when the connected equipment turns off.

To stop recording

Press **REC STOP** or **SYNCHRO REC**.

To cancel Synchro Rec

Press **SYNCHRO REC**.

The **SYNCHRO REC** indicator on the recorder turns off.

Notes

- The recorder starts recording only after detecting the video signal from the connected equipment. The beginning of the programme may not be recorded regardless of whether or not the recorder’s power is on or off.
- During Synchro-Recording, other operations such as normal recording cannot be done.
- To use the connected equipment while the recorder is standing by for Synchro-Recording, cancel Synchro-Recording by pressing **SYNCHRO REC**. Be sure to turn off the connected equipment and press **SYNCHRO REC** to reset Synchro-Recording before the timer recording starts.
- The Synchro Rec function does not work with some tuners. For details, see the tuner’s operating instructions.
- While the recorder is standing by for Synchro-Recording, the Auto Clock Set function (page 74) does not work.

If the timer settings of a Synchro-Recording and another timer recording overlap

Regardless of whether or not the programme is a Synchro Rec programme, the programme that starts first has priority and the second programme starts recording only after the first programme has finished.

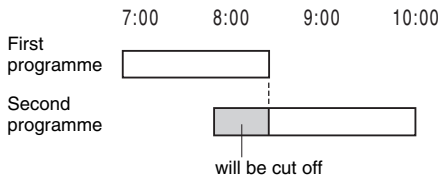

Recording from connected equipment without a timer

You can record from a connected VCR or similar device. To connect a VCR or similar device, see “Connecting a VCR or Similar Device” on page 23.

1 Insert a recordable DVD.

See “Inserting a Disc” (page 26).

2 Press INPUT SELECT to select an input source according to the connection you made.

The front panel display changes as follows:

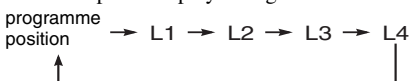

3 Select the line input audio when recording a bilingual programme on the DVD-RWs (VR mode).

Press TOOLS to select “Line Audio Input,” and press ENTER. Then select “Bilingual,” and press ENTER.

4 Press REC MODE repeatedly to select the recording mode.

For details about the recording mode, see page 45.

5 Press ■ REC PAUSE to set this recorder to record pause.

6 Insert the source tape into the connected equipment and set to playback pause.

7 At the same time, press ■ REC PAUSE on this recorder and the pause or play button on the connected equipment.

Recording starts.

To stop recording, press ■ REC STOP on this recorder.

Hint

You can adjust the settings for the recording picture before recording. See “Adjusting the recording picture quality and size” on page 50.

Notes

- When recording a video game image, the screen may not be clear.
- Any programme that contains a Copy-Never copy guard signal cannot be recorded. The recorder continues to record, but a blank screen will be recorded.

Before Editing

This recorder offers various edit options for various disc types. Before you edit, check the disc type in the front panel display, and select the option available for your disc (page 8).

Notes

- You may lose the edited contents if you remove the disc or a timer recording starts while editing.
- DVD discs created by DVD video cameras cannot be edited on this recorder.

Edit options for DVD-RWs (VR mode)

-RWVR

You can enjoy advanced edit functions. First you have two options for DVD-RWs (VR mode): editing either the original recording (called the “original”), or the playback information created from the original (called a “Playlist”). Since each is different in nature and offers different merits, read the following and select the one that better suits your needs.

To edit original titles

Edits made to the original titles are final. If you plan to retain an unaltered original recording, create and edit a Playlist (see below). The edit functions available for original titles are:

- Labelling a title (page 68).
- Setting protection against erasure (page 68).
- Erasing a title (page 68).
- Erasing multiple titles (page 70).
- Erasing a section of a title (A-B Erase) (page 69).
- Erasing all titles on the disc (page 70).
- Erasing a chapter (page 69).

To create and edit Playlist titles

A Playlist is a group of Playlist titles created from the original title for editing purposes. When you create a Playlist, only the control information necessary for playback, such as the playback order, is stored on the disc. Since the original titles are left unaltered, Playlist titles can be re-edited.

Example: You have recorded the final few matches of a football tournament on a DVD-RW (VR mode). You want to create a digest with the goal scenes and other highlights, but you also want to keep the original recording.

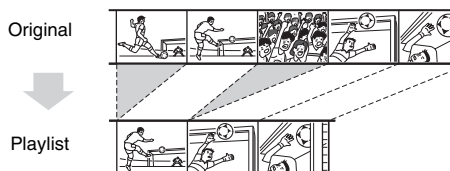

In this case, you can compile highlight scenes as a Playlist title. You can even rearrange the scene order within the Playlist title (“Creating and Editing a Playlist” on page 71).

The advanced edit functions available for Playlist titles are:

- Labelling a title (page 68).
- Erasing a title (page 68).
- Erasing multiple titles (page 70).
- Erasing a section of a title (A-B Erase) (page 69).
- Rearranging the title order (page 72).
- Dividing a title into multiple titles (page 73).
- Combining multiple titles into one title (page 72).
- Erasing a chapter (page 69).

Hint

You can display the disc’s Playlist titles in the Title List (Playlist), or the original titles in the Title List (Original). To switch the two Title Lists, press TOOLS while a Title List is displayed, and select “Original” or “Playlist.”

Notes

- The Playlist title calls up data from the original titles for playback. When an original title is used for a Playlist title, the original title cannot be erased.
- If a message appears and indicates that the disc’s control information is full, erase or edit unnecessary titles.

Edit options for DVD+RWs/DVD-RWs (Video mode)/DVD+Rs/DVD-Rs

+RW -RWVideo +R -R

You can perform simple edits. Since Video mode titles are actual recordings on the disc, you cannot undo any edits you make. The edit functions available for Video mode titles are:

- Setting protection against erasure (page 68).
- Labelling a title (page 68).
- Erasing a title (page 68).
- Erasing multiple titles (page 70).
- Erasing a section of a title (A-B Erase) (DVD+RWs only) (page 69).
- Erasing all titles on the disc (page 70).
- Erasing titles to open up disc space (Disc Map) (DVD+RWs and DVD-RWs (Video mode) only) (page 70).

Notes

- When editing a DVD+R or DVD-R, finish all editing before finalising the disc. You cannot edit a finalised disc.
- The available disc space does not increase even when you erase titles for DVD+Rs and DVD-Rs.
- If a message appears and indicates that the disc's control information is full, erase or edit unnecessary titles.

Erasing and Editing a Title

+RW -RWVR -RWVideo +R -R

This section explains the basic edit functions. Note that editing is irreversible. To edit the DVD-RWs (VR mode) without changing the original recordings, create a Playlist title (page 71).

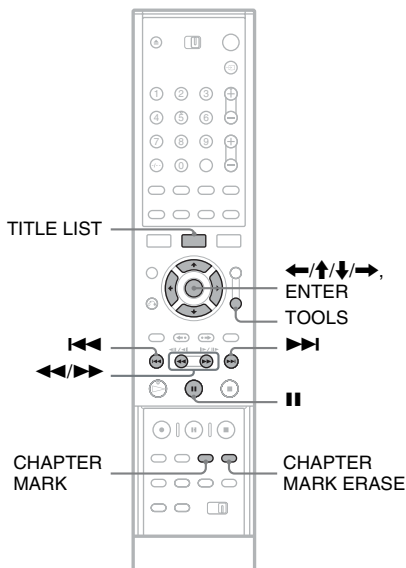

1 Press TITLE LIST.

For DVD-RWs in VR mode, press TOOLS and select “Original” or “Playlist” from the TOOLS menu to switch the Title Lists, if necessary.

2 Select a title, and press ENTER.

The sub-menu appears.

3 Select an option, and press ENTER.

You can make the following edits to the title. “Erase”: Erases the selected title. Select “OK” when asked for confirmation.

“Protect”: Protects the title. Select “On” when the Protection display appears. “” appears next to the protected title. To cancel the protection, select “Off.”

“Title Name”: Allows you to enter or re-enter a title name (page 33).

“Set Thumbnail”: Changes the title’s thumbnail picture that appears in the Title List (page 31).

“A-B Erase”: Erases a section of the title (page 69).

“Delete Chapter”: Erases chapter units of the title while viewing thumbnails (see below).

Hints

- You can erase multiple titles at one time (page 70), or erase all of the titles on the disc at once (page 70).
- You can automatically erase titles that have already played.
- You can label or re-label DVDs (page 35).

Note

DVD-RW (VR mode) playlist titles cannot be protected.

Erasing a chapter (Delete Chapter)

-RWVR

Thumbnails are displayed for each chapter. You can easily select and erase a section in a title. Note that erasing a chapter cannot be undone.

1 After step 2 of “Erasing and Editing a Title,” select “Delete Chapter,” and press ENTER.

2 Select a thumbnail of the chapter using  , and press ENTER.

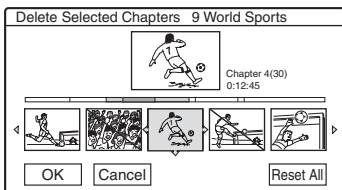

- To cancel the selection, press ENTER again.
- To erase multiple chapters, repeat step 2.
- To reset all selections, select “Reset All.”

3 Select “OK,” and press ENTER.

The display asks for confirmation.

4 Select “Yes,” and press ENTER.



Erasing a section of a title (A-B Erase)

+RW -RWVR

You can select a section (scene) in a title and erase it. Note that erasing scenes in a title cannot be undone.

1 After step 2 of “Erasing and Editing a Title,” select “A-B Erase” and press ENTER.

The display for setting point A appears.

- To return to the beginning of the title, press  and then press .

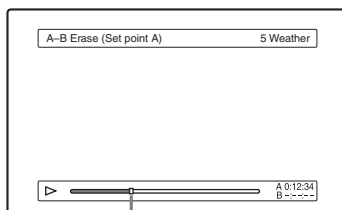

Playback point

2 Select point A by pressing  , and press ENTER.

The display for setting point B appears.

3 Select point B by pressing  , and press ENTER.

The display asks for confirmation.

- To reset either point A or B, select “Change A” or “Change B,” and go to step 2 or 3.
- To preview the title without scenes to be erased, select “Preview” (except for DVD+RWs).

4 Select “OK,” and press ENTER.

The scene is erased, and the display asks whether to erase another scene.

- To continue, select “Yes,” and repeat from step 2.
- To finish, select “No.”

Hint

A chapter mark is inserted after the scene was erased. The chapter mark divides the title into separate chapters on either side of the mark.

Notes

- Images or sound may be momentarily interrupted at the point where you erase a section of a title.
- Sections shorter than five seconds may not be erased.
- For DVD+RWs, the erased section may be slightly different from the points you selected.

Erasing multiple titles (Erase Titles)

+RW -RWVR -RWVideo +R -R

You can select and erase more than one title at one time using the TOOLS menu.

- 1 Press **TITLE LIST**.
- 2 Press **TOOLS** to select “Erase Titles,” and press **ENTER**.

The display for selecting titles to be erased appears.

- 3 Select a title, and press **ENTER**.

A check mark appears in the check box next to the selected title.

- To clear the check mark, press **ENTER** again.
- To clear all of check marks, select “Reset All.”

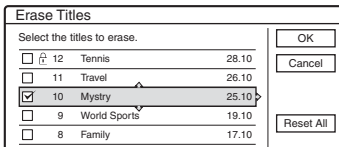

- 4 Repeat step 3 to select all of the titles you want to erase.

- 5 When you finish selecting titles, select “OK,” and press **ENTER**.

The list of the titles to be erased appears for confirmation.

- To change the selection, select “Change,” and repeat from step 3.

- 6 Select “OK” and press **ENTER**.

The titles are erased.

Erasing all titles on the disc

+RW -RWVR -RWVideo +R -R

- 1 Press **TOOLS** to select “Disc Info,” and press **ENTER**.

The “Disc Information” display appears.

- 2 Select “Erase All,” and press **ENTER**.

- 3 Select “OK,” and press **ENTER**.

All titles on the disc are erased (except the protected titles).

Erasing titles to open up disc space (Disc Map)

+RW -RWVideo

When recording on a DVD+RW or DVD-RW (Video mode), the recorder searches for the largest open space and records there. Before you start, check the disc status by using Disc Map, and erase titles to create a space large enough for the recording.

- 1 Insert a disc and press **TITLE LIST**.
- 2 Press **TOOLS** to select “Disc Map,” and press **ENTER**.

The “Disc Map” display appears.

- To check the open space, select the space by pressing **←/→**.

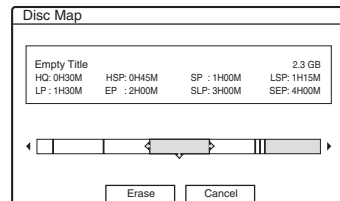

- When **←** or **→** appears on either side of the screen, you can scroll sideways by pressing **←/→**.

3 Select a title by pressing ←/→, and press ENTER.

The display for selecting titles to be erased appears.

- To cancel the selection, press ENTER again.
- To erase more titles, repeat step 3.

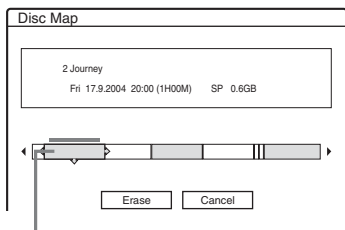

Selected title

4 Select “Erase,” and press ENTER.

The display asks for confirmation.

5 Select “OK,” and press ENTER.

The selected titles are erased, freeing up disc space.

- To change the selection, select “Change.”

Creating chapters manually

-RWVR

You can manually insert a chapter mark at any point you like during playback or recording.

Press CHAPTER MARK at the point where you want to divide the title into chapters.

Each time you press the button, “Marking...” appears on the screen and the scenes to the left and right of the mark become separate chapters.

To erase chapter marks

You can combine two chapters by erasing the chapter mark during playback.

Press ◀◀/▶▶ to search for a chapter number, and while displaying the chapter containing the chapter mark you want to erase, press CHAPTER MARK ERASE.

The current chapter combines with the previous chapter.

Note

- To insert a chapter mark manually during recording, set “Auto Chapter” in “Features” setup to “Off.”

Creating and Editing a Playlist

-RWVR

Playlist edit allows you to edit or re-edit without changing the actual recordings. You can create up to 97 Playlist titles.

Note

Once you create a Playlist title from original titles, you will be unable to erase or edit the original titles.

1 Press TITLE LIST.

2 Press TOOLS to select “Create Playlist,” and press ENTER.

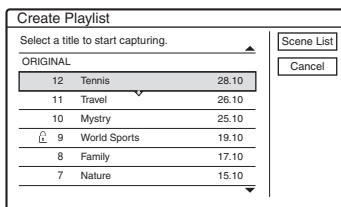

3 Select the title you want to include in the Playlist title, and press ENTER.

The sub-menu appears.

“Capture”: Adds a section of the title to the Playlist title as one scene.

“Capture All”: Adds the entire title to the Playlist title as one scene. After capturing the title, go to step 8.

4 Select “Capture,” and press ENTER.

The display for setting the start point (IN) appears. The title starts to play in the background.

- To return to the beginning of the title, press ■ and then press ◀◀.

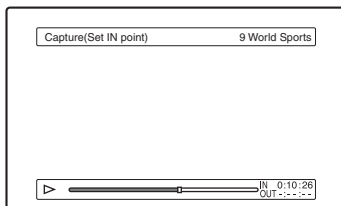

5 Select the IN point by pressing ◀◀/▶▶, and press ENTER.

The display for setting the end point (OUT) appears, and the title continues to play in the background.

6 Select the OUT point by pressing ◀◀/▶▶, and press ENTER.

The display asks for confirmation.

To reset the IN or OUT point, select “Change IN” or “Change OUT” and repeat step 5 or 6. To view the selected scene, select “Preview.”

7 Select “OK,” and ENTER.

The Scene List menu appears with all of the selected scenes.

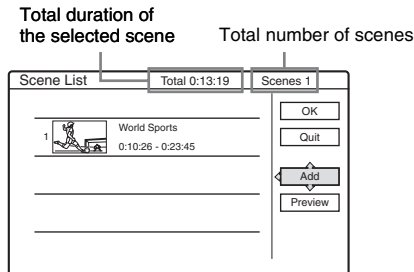

- To add more scenes, select “Add” and go to step 3.
- To preview all of the captured scenes in the listed order, select “Preview.”

8 Select the scene you want to re-edit, and press ENTER.

The sub-menu appears.

“Move”: Changes the scene order.

“Erase”: Erases the scene. The selection is cancelled.

“Preview”: Displays thumbnail pictures of the scenes.

“Change IN”: Allows you to change the IN point, and repeat from step 5.

“Change OUT”: Allows you to change the OUT point, and repeat from step 6.

9 When you finish editing the Scene List, select “OK,” and press ENTER.

The display for entering the title name appears. To enter a new name, select “Enter” (page 33).

10 Select “OK” to use the default name, and press ENTER.

To play the Playlist title

Press TOOLS while the Title List menu is turned on. Then, select “Playlist” and press ENTER.

When the Title List (Playlist) menu appears, select a title and press ▷.

💡 Hint

When a Playlist title is created, the IN and OUT points will become chapter marks, and each scene will become a chapter.

⚠ Note

The picture may pause when the edited scene is played.

Moving a Playlist title (Change Order)

-RWVR

You can change the Playlist title order within the Title List (Playlist).

1 Press TITLE LIST to turn on the Title List (Playlist) menu.

If the Title List (Original) menu appears, press TOOLS and select “Playlist.”

2 Select the title you want to move, and press ENTER.

The sub-menu appears.

3 Select “Change Order,” and press ENTER.

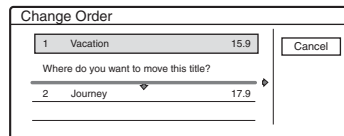

4 Select a new location for the title by pressing ↑/↓, and press ENTER.

The title moves to the new location.

Combining multiple Playlist titles (Combine)

-RWVR

1 Press TITLE LIST to turn on the Title List (Playlist) menu.

If the Title List (Original) menu appears, press TOOLS and select “Playlist.”

2 Press **TOOLS** to select “Combine,” and press **ENTER**.

The display for selecting titles appears.

3 Select a title, and press **ENTER**.

A number indicating the order in which you selected the title appears.

To cancel the selection, press **ENTER** again.

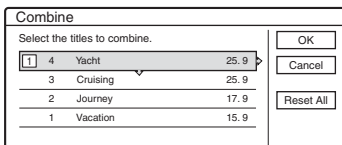

4 Repeat step 3 to select all of the titles you want to combine.

To cancel all of the selections, select “Reset All.”

5 Select “OK,” and press **ENTER**.

The list of titles to be combined appears.

To change the selection, select “Change” and go to step 3.

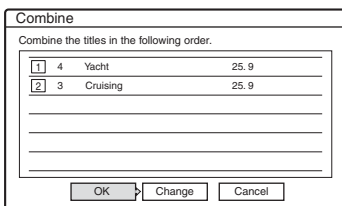

6 Select “OK,” and press **ENTER**.

The display for selecting a title name from among the selected titles appears.

To enter a new name, select “Enter Text,” and follow the explanations on page 33.

To change the selection, select “Change” and go to step 3.

7 Select a name, and press **ENTER**.

The titles are combined.

Note

When the number of chapters in the title to be combined exceeds the limit, the chapters at the end are combined into a single chapter.

Dividing a Playlist title (Divide)

-RWVR

You can divide a Playlist title.

1 Press **TITLE LIST**.

Press **TOOLS** and select “Playlist” from the **TOOLS** menu to switch the Title Lists, if necessary.

2 Select a title, and press **ENTER**.

The sub-menu appears.

3 Select “Divide,” and press **ENTER**.

The display for setting the dividing point appears. The title starts to play in the background.

- To return to the beginning of the title, press **II** and then press **II<<<**.

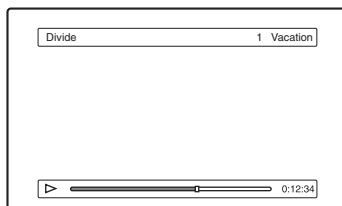

4 Select the dividing point by pressing **<< and **>>>**, and press **ENTER**.**

The display asks for confirmation.

- To change the dividing point, select “Change.”

5 Select “OK,” and press **ENTER**.

The display for entering the title name appears.

- To use the same title name as before, select “No.”

6 Select “Yes,” and press **ENTER** to enter a new name.

Follow the explanations on page 33. After you enter a new name, the title is divided in two.

Playback

Playing

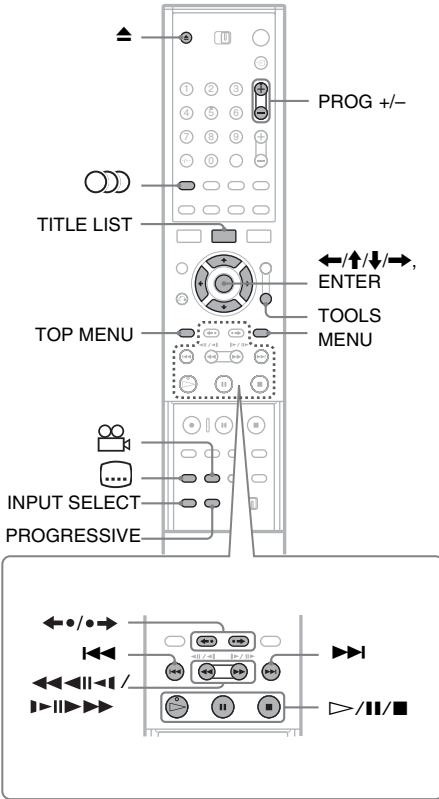

1 Insert a disc.

- See “Inserting a Disc” (page 26).
- If you insert a DVD VIDEO, VIDEO CD, or CD, press \triangleright . Playback starts.

2 Press TITLE LIST.

For details about the Title List, see “3. Playing the Recorded Programme (Title List)” on page 29.

Example: DVD-RW (VR mode)

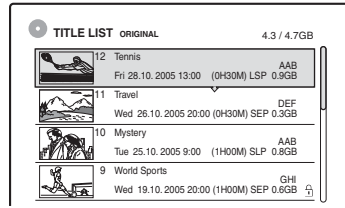

3 Select the title, and press ENTER.

The sub-menu appears.

4 Select “Play,” and press ENTER.

Playback starts from the selected title.

To use the DVD’s Menu

When you play a DVD VIDEO, or a finalised DVD+RW, DVD-RW (Video mode), DVD+R, or DVD-R, you can display the disc’s menu by pressing TOP MENU or MENU.

To play VIDEO CDs with PBC functions

PBC (Playback Control) allows you to play VIDEO CDs interactively using the menu on your TV screen.

When you start playing a VIDEO CD with PBC functions, the menu appears.

Select an item using the number buttons and press ENTER. Then, follow the instructions in the menu (press \triangleright when “Press SELECT” appears).

The PBC function of Super VIDEO CDs does not work with this recorder. Super VIDEO CDs are played in continuous play mode only.

To stop playback

Press \blacksquare .

To resume playback from the point where you stopped (Resume Play)

When you press \triangleright again after you stop playback, the recorder resumes playback from the point where you pressed \blacksquare .

To start from the beginning, press TOOLS to select “Play Beginning,” and press ENTER. Playback starts from the beginning of the title/track/scene.

The point where you stopped playing is cleared when:

- you open the disc tray.
- you play another title.
- you switch the Title List menu to Original or Playlist (DVD-RW in VR mode only).
- you edit the title after stopping playback.
- you change the settings on the recorder.
- you turn off the recorder (VIDEO CD/CD/DATA DVD/DATA CD only).
- you make a recording (except for DVD-RWs in VR mode).
- you switch between JPEG and MP3.

To play restricted DVDs (Parental Control)

If you play a restricted DVD, the message “Do you want temporarily change parental control to *?” appears on your TV screen.

- 1** Select “OK” and press ENTER.
The display for entering your password appears.
- 2** Enter your four-digit password using the number buttons.
- 3** Press ENTER to select “OK.”
The recorder starts playback.

To register or change the password, see “Parental Control (DVD VIDEO only)” on page 83.

To lock the disc tray (Child Lock)

You can lock the disc tray to prevent children from ejecting the disc.

When the recorder is turned on, hold down \blacksquare until “LOCKED” appears in the front panel display.

The \blacktriangle (open/close) button does not work while the Child Lock is set.

To unlock the disc tray, hold down \blacksquare until “UNLOCKED” appears in the front panel display when the recorder is turned on.

One Touch Play

If you use the SMARTLINK connection, you can easily start playing.

Press \triangleright . The recorder and your TV automatically turn on and the TV’s input is switched to the recorder. Playback starts automatically.

One Touch Menu

If you use the SMARTLINK connection, you can easily display the Title List.

Press TITLE LIST. The recorder and your TV automatically turn on and the TV’s input is switched to the recorder. The Title List appears.

Hints

- You can also use the \triangleright button in step 3 (page 56) to start playback.
- Even if you select “Factory Setup” in “Options” setup (page 86), the Child Lock remains set.

Playback options

To check the position of the buttons below, see the illustration on page 56.

Buttons	Operations								
(audio) 	Selects one of the audio tracks recorded on the disc when pressed repeatedly. : Selects the language. : Selects the main or sub sound. : Selects stereo or monaural audio tracks.								
(subtitle) 	Selects a subtitle language when pressed repeatedly.								
(angle) 	Selects an angle when pressed repeatedly. If various angles (multi-angles) for a scene are recorded on the disc, “ ” appears in the front panel display.								
PROGRESSIVE 	Switches the type of video output signal to interlace or progressive format (page 16).								
(instant replay/ instant advance) 	Replays the scene/briefly fast forwards the scene.								
(previous/ next)	Goes to the beginning of the previous/next title/chapter/scene/track.								
(fast reverse/fast forward)	Fast reverses/fast forwards the disc when pressed during playback. Search speed changes as follows: <div style="text-align: center; margin: 10px 0;"> <table style="margin: auto;"> <tr> <td style="padding: 0 10px;">fast reverse</td> <td style="padding: 0 10px;">fast forward</td> </tr> <tr> <td style="text-align: center;">◀◀1 ←</td> <td style="text-align: center;">→ 1▶▶</td> </tr> <tr> <td style="text-align: center;">◀◀2 ← ←</td> <td style="text-align: center;">→ → 2▶▶</td> </tr> <tr> <td style="text-align: center;">◀◀3 ← ← ←</td> <td style="text-align: center;">→ → → 3▶▶*</td> </tr> </table> </div> When you press and hold the button, fast forward/fast reverse continues at the selected speed until you release the button. <p style="margin-top: 10px;">* ◀◀3 and 3▶▶ are only available for DVDs.</p>	fast reverse	fast forward	◀◀1 ←	→ 1▶▶	◀◀2 ← ←	→ → 2▶▶	◀◀3 ← ← ←	→ → → 3▶▶*
fast reverse	fast forward								
◀◀1 ←	→ 1▶▶								
◀◀2 ← ←	→ → 2▶▶								
◀◀3 ← ← ←	→ → → 3▶▶*								
(slow, freeze frame) *	Plays in slow motion when pressed for more than one second in pause mode. Plays one frame at a time when pressed briefly in pause mode.								
* Playback direction only									
(pause)	Pauses playback.								

To resume normal playback, press .

Notes

- Angles and subtitles cannot be changed with titles recorded on this recorder.
- 96 kHz PCM audio and DTS audio do not have surround effects.
- The surround effects do not work while performing playback quickly with sound.

Notes on playing DTS sound tracks on a CD

- When playing DTS-encoded CDs, excessive noise will be heard from the analogue stereo jacks. To avoid possible damage to the audio system, the consumer should take proper precautions when the analogue stereo jacks of the recorder are connected to an amplification system. To enjoy DTS Digital Surround™ playback, an external 5.1-channel decoder system must be connected to the digital jack of the recorder.
- Set the sound to “Stereo” using the  (audio) button when you play DTS sound tracks on a CD (page 58).

Notes on playing DVDs with a DTS sound track

DTS audio signals are output only through the DIGITAL OUT (COAXIAL or OPTICAL) jack.

When you play a DVD with DTS sound tracks, set “DTS” to “On” in “Audio” setup (page 82).

Adjusting the picture quality

+RW -RWVR -RWVideo +R -R DVD
VCD

1 Press TOOLS during playback to select “Video Settings,” and press ENTER.

Video Settings	
Select the item you want to change.	
Y NR :	2
C NR :	2
BNR :	2
MNR :	1
DVE :	Off
PB Video Equalizer	

2 Select an item, and press ENTER.

The adjustment display appears.

“Y NR” (luminance noise reduction):

Reduces noise contained in the luminance element of the video signal.

“C NR” (chroma noise reduction): Reduces noise contained in the colour element of the video signal.

“BNR” (block noise reduction): Reduces “block noise” or mosaic like patterns in the picture.

“MNR” (mosquito noise reduction): Reduces the faint noise appearing around the outlines of the images. The noise reduction effects are automatically adjusted within each setting range according to the video bit rate and other factors.

“DVE” (digital video enhancer): Sharpens the outlines of the images.

“PB Video Equalizer” (Playback video equalizer): Adjusts the picture in greater detail.

Select an item and press ENTER.

- Contrast: changes the contrast.
- Brightness: changes the overall brightness.
- Colour: makes the colours deeper or lighter.
- Hue: changes the colour balance.

3 Press ←/→ to adjust the setting, and press ENTER.

The default settings are underlined.

“Y NR”: (weak) Off 1 2 3 (strong)

“C NR”: (weak) Off 1 2 3 (strong)

“BNR”: (weak) Off 1 2 3 (strong)

“MNR”: (weak) Off 1 2 3 (strong)

“DVE”*: (weak) Off 1 2 3 (strong)

“PB Video Equalizer”:

- Contrast: (weak) -3 ~ 0 ~ 3 (strong)
- Brightness: (dark) -3 ~ 0 ~ 3 (bright)
- Colour: (light) -3 ~ 0 ~ 3 (deep)
- Hue: (red) -3 ~ 0 ~ 3 (green)

Repeat steps 2 and 3 to adjust any other items.

* “1” softens the outlines of the images. “2” enhances the outlines and “3” enhances them more than “2.”

🔊 Notes

- If the outlines of the images on your screen become blurred, set “BNR” and/or “MNR” to “Off.”
- Depending on the disc or the scene being played, the above BNR, MNR, Y NR, or C NR effects may be hard to discern. And, these functions may not work with some screen sizes.
- When using the DVE function, noise found in the title may become more apparent. In this case, it is recommended that you use the BNR function with the DVE function. If the condition still does not improve, set the DVE level to “1” or “Off.”

Adjusting the sound quality



1 Press TOOLS during playback to select “Audio Settings,” and press ENTER.

2 Select an item, and press ENTER.

“Surround” (TVS): Selects one of the surround modes.

TVS* (TV Virtual Surround) lets you enjoy virtual surround sound effects created from the front left and right speakers. The selected setting is displayed in the front panel display for a few seconds.

- Off: No surround effect
- Dynamic: Creates one set of virtual rear speakers.
- Wide: Creates five sets of virtual rear speakers.
- Night: Creates five sets of virtual rear speakers. Effective at low volume.

- Standard: Creates three sets of virtual rear speakers. Effective when you use two separate front speakers.

*TVS was developed by Sony to produce home surround sound with just a stereo TV.

“Audio Filter”: Selects the digital filter to reduce noise above 22.05 kHz (Fs* is 44.1 kHz), 24 kHz (Fs is 48 kHz), or 48 kHz (Fs is above 96 kHz).

- Sharp(default): Provides a wide frequency range and spatial feeling.
 - Slow: Provides smooth and warm sound.
- “AV SYNC”: When the video is delayed, this function delays the audio for synchronization with the video (0 to 120 milliseconds). Larger numbers indicate a longer audio delay for synchronization with the video. When dubbing to a VCR or other video recording equipment, be sure to return this setting to 0 ms (default).

* Sampling frequency of audio source. This function only adjusts the output signals from the LINE 1 – TV, LINE 3, or LINE 2 OUT (AUDIO L/R).

3 Press ←/↑/↓/→ to select the option, and press ENTER.

🔊 Notes

- There may be little effect by changing the Audio Filter depending on the disc or playback environment.
- To enjoy the surround TVS modes, set “Digital Out” to “On” and “Dolby Digital” to “D-PCM” and “MPEG” to “PCM” in “Audio” setup.
- The volume may be reduced when surround effects are set.
- When the playback signal does not contain a signal for the rear speakers, the surround effects will be difficult to hear.
- In addition, the surround effects may also be difficult to hear depending on the title being played and the environment where the recorder is being used.
- When you select one of the surround modes, turn off the surround settings of the connected TV or amplifier (receiver).
- Make sure that your listening position is between and at an equal distance from your speakers, and that the speakers are located in similar surroundings.
- When you use the DIGITAL OUT (COAXIAL) jack to listen to MPEG audio signals and set “MPEG” to “MPEG” in “Audio” setup, no sound will come from your speakers if you select one of the TVS modes.
- The surround effects do not work while performing playback quickly with sound.

Playing from the beginning of the programme you are recording (Chasing Playback)

-RWVR

“Chasing Playback” allows you to view the recorded part of a programme while the recording is being made. You do not need to wait until the recording finishes.

Press TOOLS while recording to select “Chasing Playback,” and press ENTER.

Playback starts from the beginning of the programme you are recording.

When you fast forward to the point that you are recording, Chasing Playback returns to normal playback.

Notes

- For DVD-RWs (VR mode), this function does not work when recording:
 - on a 1x-speed DVD-RW.
 - in the HQ or HSP recording mode.
- The DVD’s picture on your TV screen freezes for a few seconds when you fast forward/fast reverse or instant replay/advance the recording.
- Chasing Playback is possible from one minute or more after recording starts.
- Even if you fast forward the recorded programme, there will always be a time difference of about one minute or more between the recorded programme and the current TV broadcast.

Playing a previous recording while making another (Simultaneous Rec and Play)

-RWVR

You can play a previously recorded program while recording another on the same disc. Playback continues even if the recording is a timer recording.

1 While recording, press TITLE LIST.

The Title List appears.

2 Select the title you want to play, and press ENTER.

The sub-menu appears.

3 Select “Play”, and press ENTER.

Playback starts from the selected title.

Notes

- This function does not work when recording:
 - on a 1x-speed DVD-RW (digital video disc-rewritable, minus RW).
 - in the HQ or HSP recording mode.
- When playing a title recorded in the HQ or HSP recording mode, picture noise may appear depending upon the condition of the recording.
- Picture noise may appear depending upon the condition of the recording, or when playing a title recorded in the HQ or HSP recording mode. The picture freezes for a few seconds when you use fast forward/fast reverse or instant replay/advance.

Searching for a Title/ Chapter/Track, etc.

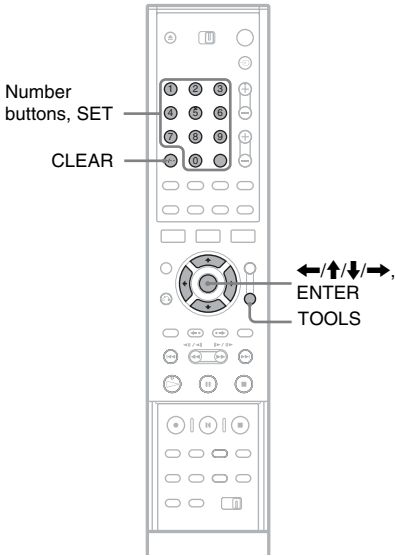

Searching by Thumbnail (Visual Search)



Each chapter is displayed as a thumbnail. You can search for the desired scene visually.

- 1 Press **TOOLS** during playback to select “Visual Search,” and press **ENTER**.

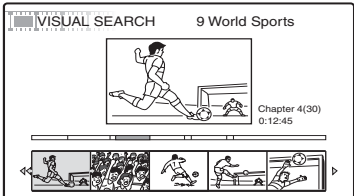

- 2 Select a scene using **←/→**, and press **ENTER**.
Playback of the selected scene is started.

Searching by title number or time code



You can search a disc by title, chapter, scene or track. As titles and tracks are assigned individual numbers, select the title or track by entering its number. You can also search for a scene using the time code.

- 1 Press **TOOLS** during playback to select a search method, and press **ENTER**.
 “Title Search” (for DVDs)
 “Chapter Search” (for DVDs)
 “Track Search” (for CDs/DATA CDs)
 “Search” (for VIDEO CDs)
 “Album Search” (for DATA DVDs/DATA CDs)
 “Time Search” (for DVDs): Searches for a starting point by entering the time code.
 “File Search” (for DATA DVDs/DATA CDs)

The display for entering the number appears.
Example: Title Search



The number in parentheses indicates the total number of titles, tracks, etc.

- 2 Press the number buttons to select the number of the title, chapter, track, time code, etc., you want.

For example: Time Search
To find a scene at 2 hours, 10 minutes, and 20 seconds, enter “21020.”

If you make a mistake, press **CLEAR** to cancel the number, then select another number.

- 3 Press **SET**.
The recorder starts playback from the selected number.

Playing MP3 Audio Tracks or JPEG Image Files

DATA DVD DATA CD

You can play MP3 audio tracks and JPEG image files on DATA CDs (CD-ROMs/CD-Rs/CD-RWs) or JPEG image files on DATA DVDs (DVD-ROMs/DVD+RWs/DVD+Rs/DVD-RWs/DVD-Rs).

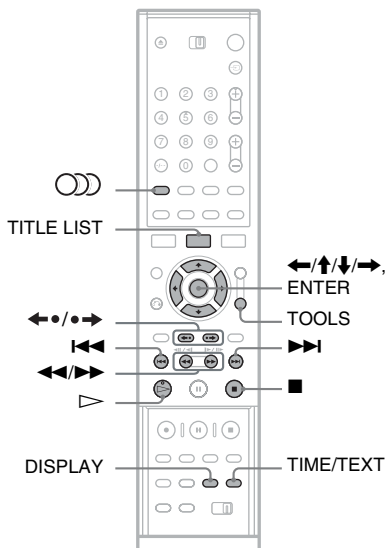

1 Insert a disc.

See “Inserting a Disc” on page 26.

2 Press \triangleright .

For MP3 discs, playback starts from the first MP3 audio track on the disc.

For JPEG files, a slideshow of the pictures on the disc begins.

If the DATA CD contains both MP3 audio tracks and JPEG image files, playback starts from the JPEG image files the first time \triangleright is pressed.

Selecting an MP3 album or track

1 Press TITLE LIST.

The album list appears.

To change the page, press $\leftarrow \bullet / \bullet \rightarrow$.

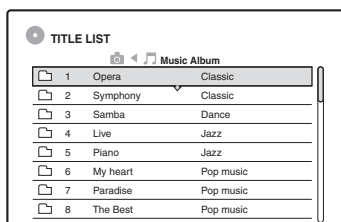

2 Select an album, and press ENTER.

The sub-menu appears.

3 Select “View Album,” and press ENTER.

The track list appears.

To change the page, press $\leftarrow \bullet / \bullet \rightarrow$.

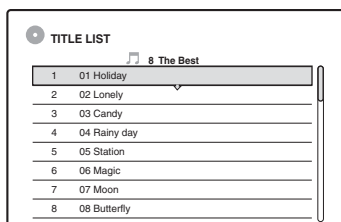

4 Select a track, and press ENTER.

“Play”: Plays the track.

“Play Beginning”: Plays the beginning of the track.

“Track Data”: Shows data about the track such as artist and album name.

To stop playback

Press \blacksquare .

To fast review or forward a track

Press \lll / \ggg during playback.

To go to the previous or next MP3 audio track

Press \lll or \ggg during playback. If you repeatedly press \lll or \ggg , you will go to the previous or next album.

To go to the previous or next album

Press $\leftarrow \bullet / \bullet \rightarrow$ during playback.

Hint

Press the $\circ \circ \circ$ (audio) button to switch between stereo or monaural audio tracks.

Selecting a JPEG album or image

1 Press TITLE LIST.

The album list appears.

To change the page, press ◀/▶.

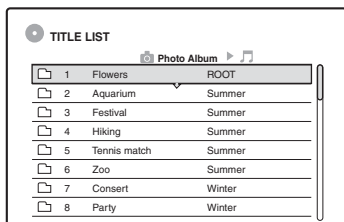

2 Select an album, and press ENTER.

The sub-menu appears.

3 Select "View Album," and press ENTER.

The image list appears.

To change the page, press ◀/▶.

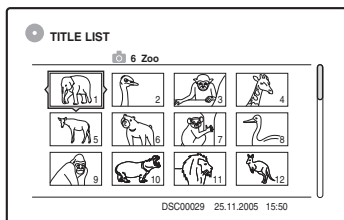

4 Select an image, and press ENTER.

"View Image": Shows the image on the entire screen.

"Slideshow": Shows the images in the album as a slideshow.

"Image Data": Shows data about when the picture was taken.

To stop viewing the JPEG image

Press ■.

To view the previous or next picture

Press ◀◀/▶▶ while the picture is displayed.

To rotate a picture

Press TOOLS while the image is displayed to select "Rotate Right" or "Rotate Left," and press ENTER.

To change the slideshow speed

Press TOOLS while the album list or image list is displayed to select "Slideshow Speed," and press ENTER. Then select the speed from "Fast" (quick), "Normal," and "Slow."

To go to the previous or next album

Press ◀/▶ while the JPEG image is displayed.

💡 Hints

- If you are playing a DATA CD that has both MP3 and JPEG files, you can switch between photo and music albums by using the ◀/▶ buttons when the album list is displayed.
- You can rotate a JPEG image by using the ◀/▶ buttons when the image is displayed.
- Press DISPLAY repeatedly to show information about the JPEG album or image on your TV screen. Then press TIME/TEXT to toggle between the current selected image number and album number.

📌 Notes

- If the DVD disc, such as a disc from a DVD video camera, contains both video and JPEG images, only the video can be played back.
- Some JPEG files, especially files of three million pixels or more, may lengthen the slideshow interval.
- Rotated JPEG images will not be saved when you press ■ or switch to another folder.
- Images larger than 720 × 480 will be reduced to 720 × 480 when displayed.
- Images larger than 4 mega bytes cannot be displayed.
- Progressive JPEG images cannot be displayed.
- When you attempt to play a broken file or a file that does not satisfy the play conditions, 📄 appears but the recorder cannot play the file.

About MP3 audio tracks and JPEG image files

MP3 is audio compression technology that satisfies certain ISO/MPEG regulations. JPEG is image compression technology.

You can play MP3 (MPEG1 Audio Layer 3) format audio tracks and JPEG image files on DATA CDs (CD-ROMs/CD-Rs/CD-RWs) or JPEG image files on DATA DVDs (DVD-ROMs/DVD+RWs/DVD+Rs/DVD-RWs/DVD-Rs).

DATA CDs discs must be recorded according to ISO9660 Level 1, Level 2 or Joliet format for the recorder to recognize the MP3 tracks. DATA DVDs must be recorded in Universal Disc Format (UDF). You can also play discs recorded in MultiSession.

See the instructions supplied with the CD-R/CD-RW/DVD-R/DVD-RW drives and the recording software (not supplied) for details on the recording format.

Note on MultiSession/Border discs

If MP3 audio tracks or JPEG image files are recorded in the first session/border, the recorder will also play MP3 audio tracks or JPEG image files in other sessions/borders. If audio tracks and images in Music CD format or Video CD format are recorded in the first session/border, only the first session/border will be played back.

Note

The recorder may not be able to play some DATA CDs/DATA DVDs created in the Packet Write format.

MP3 audio tracks or JPEG image files that the recorder can play

The recorder can play the following tracks and files:

- MP3 audio tracks with the extension “.MP3,” “.mp3,” or “Mp3.”
- JPEG image files with the extension “.JPEG,” “.jpg,” “.JPG,” “.Jpg,” “.jpeg,” or “.Jpeg.”
- JPEG image files that conform to the DCF* image file format.

* “Design rule for Camera File system”: Image standards for digital cameras regulated by JEITA (Japan Electronics and Information Technology Industries Association).

Notes

- The recorder will play any data with the extension “.MP3,” “.mp3,” “Mp3,” “.JPEG,” “.jpg,” “.JPG,” “.Jpg,” “.jpeg,” or “.Jpeg” even if they are not in MP3 or JPEG format. Playing these data may generate a loud noise which could damage your speaker system.
- The recorder does not conform to audio tracks in mp3PRO format.
- Some files cannot be played.
- The letters that cannot be displayed are replaced with “*.”

About playback order of albums, tracks, and files

Albums play in the following order:

Structure of disc contents

Tree 1 Tree 2 Tree 3 Tree 4 Tree 5

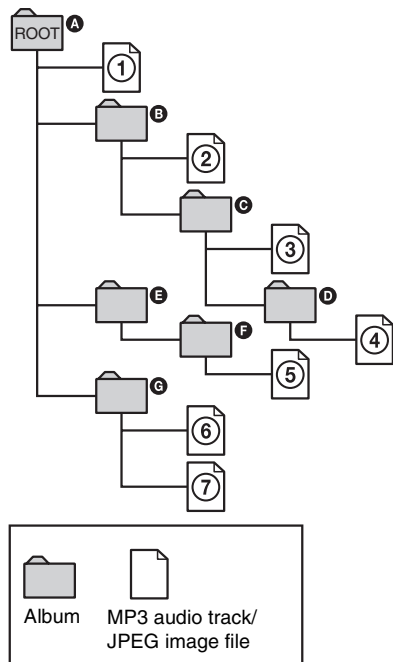

When you insert a DATA CD/DATA DVD and press \triangleright , the numbered tracks (or files) are played sequentially, from ① through ⑦.

For JPEG image file, press $\bullet \rightarrow$ to go to the next album. (For instance, when you want to go from ① to ②.)

Any sub-albums/tracks (or files) contained within a currently selected album take priority over the next album in the same tree. (Example: C contains D so ④ is played before ⑤.) When you press TITLE LIST and the list of album names appears (page 32), the album names are arranged in the following order: A \rightarrow B \rightarrow C \rightarrow D \rightarrow F \rightarrow G. Albums that do not contain tracks (or files) (such as album E) do not appear in the list.

🔦 Hints

- If you add numbers (01, 02, 03, etc.) to the front of the track/file names when you store the tracks (or files) in a disc, the tracks and files will be played in that order.

🔦 Notes

- Depending on the software you use to create the DATA DVD/DATA CD, the playback order may differ from the above illustration.
- No more than a total of 199 individual folders can be played. (Folders that do not contain JPEG/MP3 files are counted as well.)
- No more than a total of 999 folders and files can be played. (Files other than JPEG/MP3 files, and folders that do not contain JPEG/MP3 files are counted as well.)
- No more than 200 folders and files can be recognized in a single folder. (Folders that do not contain JPEG/MP3 files are counted as well.)
- Proceeding to the next or another album may take some time.
- This recorder supports MP3 audio bit rates up to 160 kbps.

Settings and Adjustments

Clock and Language Settings (Settings)

The “Settings” setup helps you to make clock and language settings for the recorder.

- 1 Press **SYSTEM MENU** while the recorder is in stop mode.
- 2 Select “**SETUP**,” and press **ENTER**.
- 3 Select “**Settings**,” and press **ENTER**.
The Settings display appears with the following options.

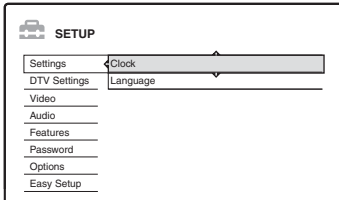

Clock

Normally the clock is set automatically thanks to the time and date information broadcasted by the local network package.

If the recorder does not receive a time signal from any service, you may set the clock manually. Therefore, please proceed as follows.

◆To set the clock manually

- 1 After step 3 above, select “**Clock**,” and press **ENTER**.

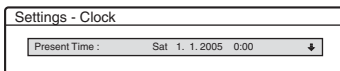

- 2 Select “**Present Time**,” and press **ENTER**.

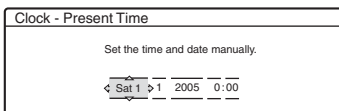

- 3 Press **↑/↓** to set the day, and press **→**.
Set the month, year, hour, and minutes in sequence. Press **←/→** to select the item to be set, then press **↑/↓** to set the numbers. The day of the week is set automatically.

To change the numbers, press **←** to return to the item to be changed, and press **↑/↓**.

- 4 Press **ENTER** to start the clock.
- 5 Press the **↶** button to come back to the Settings display.

Language

DVD Menu (DVD VIDEO only)

Switches the language for the DVD menu.

Audio

Switches the language of the sound track.

When you select “**Original**,” the language given priority in the disc (DVD VIDEO only) or broadcasted by a digital channel is selected.

Subtitle

Switches the language of the subtitles recorded on the disc (DVD VIDEO only) or broadcasted by a digital channel (when available).

When you select “**Audio Follow**,” the subtitle language changes according to the language you selected for the sound track.

💡 Hint

If you select “**Others**” in “**DVD Menu**,” “**Subtitle**,” or “**Audio**,” select and enter a language code from “**Language Code List**” on page 102 using the number buttons.

🔔 Note

If you select a language in “**DVD Menu**,” “**Subtitle**,” or “**Audio**” that is not recorded on the DVD VIDEO, one of the recorded languages will be automatically selected.

Digital TV settings (DTV Settings)

The DTV Settings Setup enables you to take full advantage of Digital TV Broadcasting services such as favourites channels setting or to prevent children's viewing unsuitable channels and programmes.

- 1 Press **SYSTEM MENU** while the recorder is in stop mode.
- 2 Select **"SETUP,"** and press **ENTER**.
- 3 Select **"DTV Settings,"** and press **ENTER**.
The DTV Settings Setup Display appears with the following options.

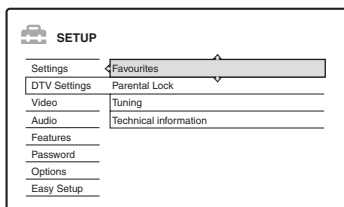

Favourites

The Favourite Display allows you to store and organize your favourite channels into one of four TV or four Radio lists.
Please refer to page 42 for detailed Favourites Channels settings.

Parental Lock

The Parental Lock Display enables you to lock certain channels you consider unsuitable and to set an age limit so that any programme classed above that age by the broadcaster is restricted.

- 1 After step 3 above, select **"Parental Lock,"** and press **ENTER**.
 - When you have already registered a password, the display for entering the password appears.

- If you have not yet registered a password, the display for registering a new password appears.

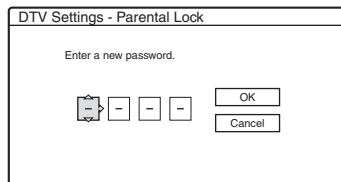

- 2 Enter your four-digit password using the **↑/↓** buttons or the number buttons, then select **"OK"** and press **ENTER**.

The Parental Lock menu appears

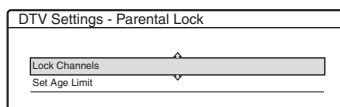

Note

If you forget your password, you will have to reset it by selecting **"Password"** under **"Factory Setup"** in Options Setup (page 86).

To lock channels

- 1 Once the Parental Lock menu displayed, select **"Lock Channels,"** and press **ENTER**.

The DTV Settings- Lock Channels display appears.

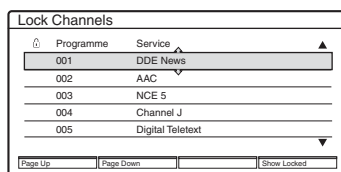

This display shows all the TV channels available to you.

- 2 Press the **↑/↓** buttons or enter a channel number to highlight a channel you want to lock, then press the **ENTER** button.

A locked channel is identified by the **🔒** icon next to the programme number

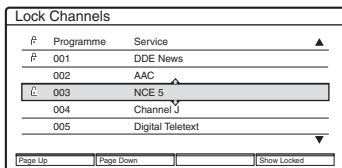

If you do not wish to lock one of the five channels in the display, press the RED or GREEN button to view the previous or next five channels available.

- 3 Press the button to come back to the Parental Lock menu.

◆ To unlock channels

- 1 In Step 2 above press the buttons to highlight the channel you want to unlock, then press ENTER: the icon next to the programme number disappears.
- 2 Press the button to come back to the Parental Lock menu.

💡 Hints

- Press the BLUE button to view the list showing only the locked channels.
- Press the BLUE button once again when you wish to return to the previous channel list display.
- Press while the Lock Channels display is turned on to change to the previous/next page.

◆ To set the Age Limit

- 1 Once the Parental Lock menu displayed, select “Set Age Limit,” and press ENTER.

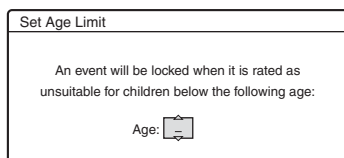

- 2 Press the buttons to set the desired age limit and press ENTER.

💡 Notes

- To operate correctly, this feature relies on the broadcaster sending the correct age classification for each programme.
- If you select the Parental Lock channel activated, “This channel has been locked” appears on the gray screen and it is recorded.

Tuning

The Tuning Display allows you to tune your recorder automatically or to hide unused or unwanted programmes and also change the order of the programmes on display. During these procedures you may be requested to enter your password. Refer to page 75 for information.

Follow steps 1 to 3 of “Digital TV settings (DTV Settings)” on page 75, then select “Tuning,” and press ENTER.

The DTV Settings - Tuning menu appears.

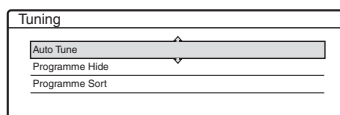

Auto Tune

This option enables you to capture and store automatically all available channels.

- 1 Once the DTV Settings - Tuning menu displayed, select “Auto Tune,” and press ENTER.

The Auto Tune Start Display appears.

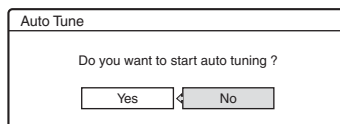

- 2 Select “Yes” in the menu option and press ENTER.

The Auto Tune display appears showing a tuning progress bar and the number of channels found.

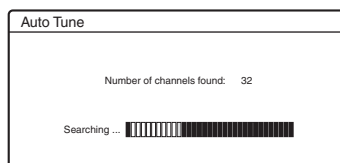

When Auto Tune has ended, a completion display appears indicating the number of TV and Radio channels that have been found and stored.

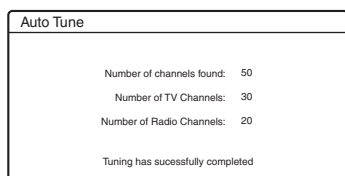

- 3 Press the ENTER button to remove the display and view the first channel captured.



Programme Hide

This option allows you to hide (disable) unused or unwanted channels.

The hidden programmes will be skipped when you press PROG +/- and will not appear in the EPG applications.

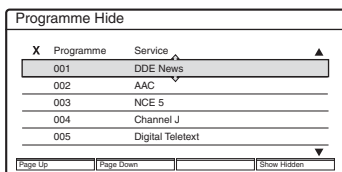
- 1 Once the DTV Settings - Tuning menu displayed, select "Programme Hide," and press ENTER. The DTV Settings- Programme Hide display appears showing all the TV or Radio channels available to you.



- 2 Press the TV/RADIO button to display either the TV or Radio channels. The Radio mode is indicated by the presence of a Radio icon  in the display.
- 3 Press the  buttons or enter a channel number to highlight a channel you want to hide, then press the ENTER button.

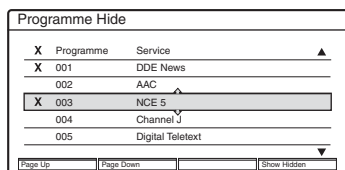

If you do not wish to choose from one of the five channels in the display, press the RED or

GREEN button to view the previous or next five channels available.

- 4 Once you have hidden the unwanted channels as desired, press the  button repeatedly to return to the main menu.

◆Restoration of hidden programmes

Hidden channels are identified by an X icon next to the programme number.

In Step 3 above press the  buttons to highlight the channel you want to restore, then press ENTER: the X icon next to the programme number disappears.

💡 Hints



- Press the BLUE button to view the list showing only the hidden channels.
- Press the BLUE button once again when you wish to return to the standard programme hide display.

Programme Sort

This option allows you to change the channel order in the on-screen programme list.

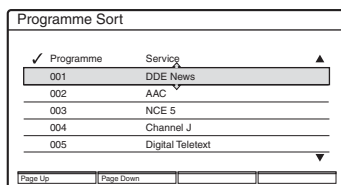
- 1 Once the DTV Settings - Tuning menu displayed, select "Programme Sort," and press ENTER. The Programme Sort Display appears showing the list of all tuned channels.



- 2 Press the  buttons or enter a programme number to highlight the channel you wish to move, then press the ENTER button. A tick  icon appears next to the selected programme number and a Swap option appears in the display.

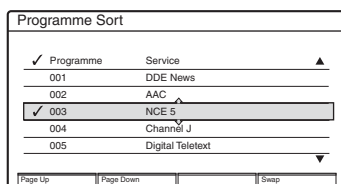

If you do not wish to choose from one of the five channels in the display, press the RED or

GREEN button to view the previous or next five channels available.

- Press the **↑/↓** buttons to highlight the programme number you wish your selected channel to appear on.

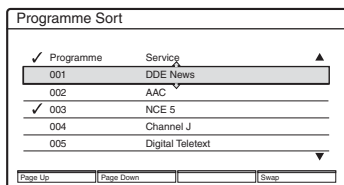

- Press the BLUE button to swap channel position. Your selected channel appears on the programme number selected in step 3.
- Repeat this procedure to move other channels.
- Once you have moved all channels as desired, press the **↶** button repeatedly to return to the main menu.

Technical Information

Follow steps 1 to 3 of “Digital TV settings (DTV Settings)” on page 75, then select “Technical Information,” and press ENTER. The DTV Settings - Technical Information menu appears.

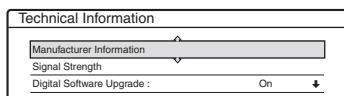

Manufacturer Information

This information screen shows you the current version of software installed in your recorder.

- Once the DTV Settings - Technical Information displayed, select “Manufacturer Information,” and press ENTER.
- After viewing the information displayed, press the **↶** button to come back to the Technical Information menu.

Signal Strength

This information screen shows the signal strength of the broadcast you are watching.

- Select “Signal Strength,” in the DTV Settings - Technical Information display and press ENTER. The Signal Strength display appears with the selected channel on view in the background.



The Signal Strength display coloured bars correspondences are as follows:

Good: (Green) Average: (Yellow) Poor: (Red)

- Press the PROG +/- buttons to check the signal strength of the other tuned channels.
- After viewing the information displayed, press the **↶** button to come back to the Technical Information menu.

Digital Software Upgrade

Periodically Sony will issue upgrades for the software that was initially installed in your recorder. These upgrades will automatically be received and enabled. If desired, you can disable this option as follows:

- Select “Digital Software Upgrade,” in the DTV Settings - Technical Information display and press ENTER.

The Digital Software Upgrade menu option appears

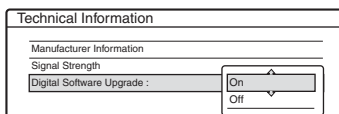

- Press the **↑/↓** buttons to highlight “Off,” and press ENTER.

Notes

- Sony recommend that you always leave this option set to “On”.
- To receive the upgrade, the unit must be powered on and watching a BBC channel. It will take up 30 minutes to upgrade the unit. The new software will be available once the unit has been placed into standby, and then back to normal operating mode.

Video Settings (Video)

Video settings will adjust items related to the image, such as size and colour.

Choose the settings according to the type of TV or tuner connected to the DVD recorder.

- 1** Press **SYSTEM MENU** while the recorder is in stop mode.
- 2** Select **"SETUP,"** and press **ENTER.**
- 3** Select **"Video,"** and press **ENTER.**

The "Video" setup appears with the following options. The default settings are underlined.

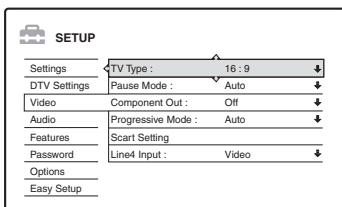

TV Type

Sets the picture size when playing back a title recorded from 16:9 size video (page 50) or a 16:9 size commercial DVD video.

Select the playback picture size according to the type of connected TV (wide-screen/wide mode TV or conventional 4:3 screen TV).

<u>16:9</u>	Select this when connecting to a wide-screen TV or TV with a wide mode function.
4:3 Letter Box	Select this when connecting to a 4:3 screen TV. Displays a wide picture with bands on the upper and lower portions of the screen.
4:3 Pan Scan	Select this when connecting to a 4:3 screen TV. Automatically displays a wide picture on the entire screen and cuts off the portions that do not fit.

16:9

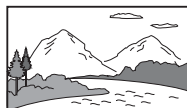

4:3 Letter Box



4:3 Pan Scan



Note

Depending on the disc, "4:3 Letter Box" may be selected automatically instead of "4:3 Pan Scan" or vice versa.

Pause Mode (DVDs only)

Selects the picture quality in pause mode.

<u>Auto</u>	The picture, including subjects that move dynamically, is output with no jitter. Normally select this position.
Frame	The picture, including subjects that do not move dynamically, is output in high resolution.

Component Out

Selects whether or not to output video signals from the COMPONENT VIDEO OUT jacks.

<u>On</u>	Outputs the component video signals. Select this when you want to view progressive signals.
<u>Off</u>	Outputs no signals.

Notes

- When you set "Line1 Output" to "RGB," you cannot set "Component Out" to "On."
- When you connect the recorder to a monitor or projector via only the COMPONENT VIDEO OUT jacks, do not select "Off." If you select "Off" in this case, the picture may not appear.

Progressive Mode

DVD software can be divided into two types: film based software and video based software. Video based software is derived from TV, such as dramas and sit-coms, and displays images at 30 frames/60 fields (25 frames/50 fields) per second. Film based software is derived from film and displays images at 24 frames per second. Some DVD software contains both Video and Film.

In order for these images to appear natural on your screen when output in PROGRESSIVE mode (50 or 60 frames per second), the progressive video signal needs to be converted to match the type of DVD software that you are watching.

You can fine-tune the progressive 525p/625p video signal that is output when you press PROGRESSIVE (“PROGRESSIVE” lights up). Note that you must connect to a progressive format TV using the COMPONENT VIDEO OUT jacks (page 14).

<u>Auto</u>	Automatically detects the software type (Film-based or Video-based) and selects the appropriate conversion mode. Normally select this position.
Video	Fixes the conversion mode to the mode for Video-based software.

Scart Setting

Sets the method of inputting/outputting signals from the SCART jacks on the rear panel of the recorder. Select an option for each of the items below according to the combination of jacks and methods that you are going to use.

◆Line1 Output

Selects a method of outputting video signals for the LINE 1 – TV jack.

RGB	Outputs RGB signals.
<u>Video</u>	Outputs video signals.
S Video	Outputs S-video signals.

🔊 Notes

- If your TV does not accept S-video or RGB signals, no picture appears on the TV screen even if you select “S Video” or “RGB.” See the instructions supplied with your TV.
- You cannot select “RGB” when “Component Out” above is set to “On.”
- SMARTLINK is available only when “Video” is selected.

◆Line3 Input

Selects a method of inputting video signals for the LINE 3 jack. The picture will not be clear if this setting does not match the type of video input signal.

<u>Video/RGB</u>	Inputs video signals or RGB signals.
S Video	Inputs S-video signals.

◆ Line3 Output

Selects a method of outputting video signals for the LINE 3 jack.

<u>Video</u>	Outputs video signals.
S Video	Outputs S-video signals.

Line4 Input

Selects a method of inputting video signals for the LINE 4 IN jack on the rear panel of the recorder.

<u>Video</u>	Inputs video signals.
S Video	Inputs S-video signals.

Audio Settings (Audio)

The “Audio” setup allows you to adjust the sound according to the playback and connection conditions.

1 Press **SYSTEM MENU** while the recorder is in stop mode.

2 Select “**SETUP**,” and press **ENTER**.

3 Select “**Audio**,” and press **ENTER**.

The “Audio” setup appears with the following options. The default settings are underlined.

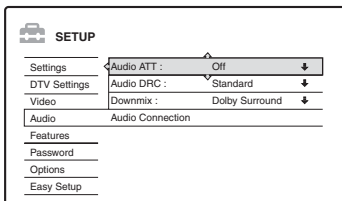

Audio ATT (attenuation)

If the playback sound is distorted, set this item to “On.” The recorder reduces the audio output level. This function affects the output of the following jacks:

- LINE 2 OUT R-AUDIO-L jacks
- LINE 1 – TV jack
- LINE 3 jack

<u>On</u>	Select this when the playback sound from the speakers is distorted.
<u>Off</u>	Normally select this position.

Audio DRC (Dynamic Range Control) (DVDs only)

Makes the sound clear when the volume is turned down when playing a DVD that conforms to “Audio DRC.” This affects the output from the following jacks:

- LINE 2 OUT R-AUDIO-L jacks
- LINE 1 – TV jack
- LINE 3 jack
- DIGITAL OUT (OPTICAL or COAXIAL) jack only when “Dolby Digital” is set to “D-PCM” (page 82).

<u>Standard</u>	Normally select this position.
TV Mode	Makes low sounds clear even if you turn the volume down.
Wide Range	Gives you the feeling of being at a live performance.

Downmix (DVDs only)

Switches the method for mixing down to two channels when you play a DVD which has rear sound elements (channels) or is recorded in Dolby Digital format. For details on the rear signal components, see “4. Displaying the Playing Time and Play Information” on page 31. This function affects the output of the following jacks:

- LINE 2 OUT R-AUDIO-L jacks
- LINE 1 – TV jack
- LINE 3 jack
- DIGITAL OUT (OPTICAL or COAXIAL) jack when “Dolby Digital” is set to “D-PCM” (page 82).

<u>Dolby Surround</u>	Normally select this position. Multi-channel audio signals are output to two channels for enjoying surround sounds.
Normal	Multi-channel audio signals are downmixed to two channels for use with your stereo.

Audio Connection

The following setup items switch the method of outputting audio signals when you connect a component such as an amplifier (receiver) with a digital input jack.

For connection details, see “Step 4: Connecting the Audio Cords” on page 17.

Select “Dolby Digital,” “MPEG,” “DTS,” and “48kHz/96kHz PCM” after setting “Digital Out” to “On.”

If you connect a component that does not accept the selected audio signal, a loud noise (or no sound) will come out from the speakers, and may affect your ears or cause speaker damage.

1 Select “Audio Connection” in “Audio,” and press **ENTER**.

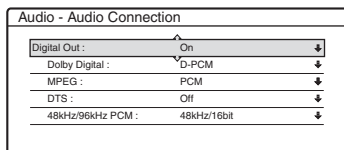

2 Select “Digital Out,” and press ENTER.

<u>On</u>	Normally select this position.
Off	The influence of the digital circuit upon the analogue circuit is minimal.

3 Select “On,” and press ENTER.

4 Set the digital output signal.

- **Dolby Digital (DVDs only)**
Selects the type of Dolby Digital signal.

<u>D-PCM</u>	Select this when the recorder is connected to an audio component lacking a built-in Dolby Digital decoder. The surround effects of output signals are determined by the “Downmix” setting item in “Audio” setup.
Dolby Digital	Select this when the recorder is connected to an audio component with a built-in Dolby Digital decoder.

- **MPEG (DVD VIDEO only)**
Selects the type of MPEG audio signal.

<u>PCM</u>	Select this when the recorder is connected to an audio component without a built-in MPEG decoder. If you play MPEG audio sound tracks, the recorder outputs stereo signals via the DIGITAL OUT (COAXIAL or OPTICAL) jack.
MPEG	Select this when the recorder is connected to an audio component with a built-in MPEG decoder.

- **DTS (DVD VIDEO only)**
Selects whether or not to output DTS signals.

<u>On</u>	Select this when the recorder is connected to an audio component with a built-in DTS decoder.
Off	Select this when the recorder is connected to an audio component without a built-in DTS decoder.

- **48kHz/96kHz PCM (DVD VIDEO only)**
Selects the sampling frequency of the audio signal.

<u>48kHz/ 16bit</u>	The DVD video audio signal is converted to 48kHz/16bit and output.
96kHz/ 24bit	All signals containing 96kHz/24bit are output without conversion. However, the signals are output at 48kHz/16bit if copyright-protected signals are contained.

Notes

- “48kHz/96kHz PCM” setting has no effect when audio signals are output from the LINE 2 OUT (R-AUDIO-L) jacks. If the sampling frequency is 96kHz, signals are simply converted to 96kHz analog signals and output.
- When you use the DIGITAL OUT (COAXIAL or OPTICAL) jack to listen to MPEG audio signals and set “MPEG” to “MPEG” in “Audio” setup, no sound will come from your speakers if you select one of the Surround TVS modes.

Recording and Parental Control Settings (Features)

The “Features” setup allows you to adjust recording and parental control settings.

1 Press **SYSTEM MENU** while the recorder is in stop mode.

2 Select “**SETUP**,” and press **ENTER**.

3 Select “**Features**,” and press **ENTER**.

The “Features” setup appears with the following options. The default settings are underlined.

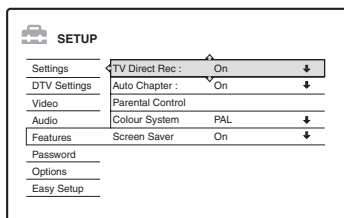

TV Direct Rec (DVD+RW/DVD-RW/DVD+R/DVD-R only)

<u>On</u>	Allows you to easily record what you are watching on the TV using SMARTLINK.
Off	Turns off the TV Direct Rec function.

Auto Chapter

Selects whether to automatically divide a recording (a title) into chapters during recording.

<u>On</u>	For a DVD-RW (VR mode), the recorder detects changes in the picture and sound and automatically inserts chapter marks. For other recordable discs, the recorder inserts chapter marks at approximately 6-minute intervals.
Off	No chapter mark is inserted.

Note

- The actual chapter mark interval may vary depending on the amount of information contained in the video to be recorded.

Parental Control (DVD VIDEO only)

Playback of some DVD VIDEOS can be limited according to a predetermined level, such as the age of the users. Scenes may be blocked or replaced with different scenes.

1 Select “Parental Control” in “Features,” and press **ENTER**.

- If you have not entered a password, the display for registering a new password appears.

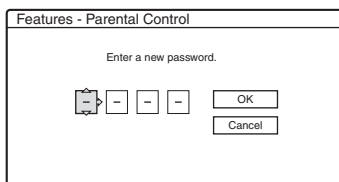

- When you have already registered a password, the display for entering the password appears.

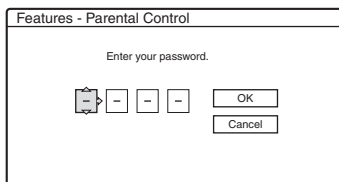

2 Enter your four-digit password using the number buttons, then select “OK” and press **ENTER**.

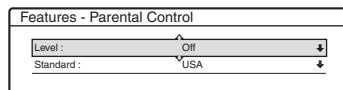

3 Select “Standard,” and press **→** or **ENTER**. The selection items for “Standard” are displayed.

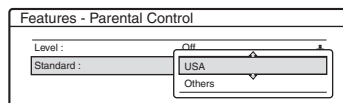

4 Select a geographic area as the playback limitation level, and press **ENTER**. The area is selected.

- When you select “Others,” press the number buttons to select and enter an area code in

the table (page 102). Then select “OK” and press ENTER.

- 5** Select “Level,” and press ENTER.
The selection items for “Level” are displayed.

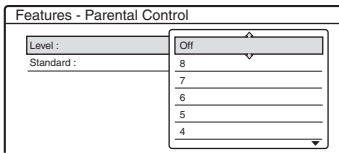

The lower the value, the stricter the limitation. Discs rated higher than the selected level will be restricted.

- 6** Select the level, and press ENTER.
The Parental Control setting is complete.

To cancel the Parental Control setting for the disc, set “Level” to “Off” in step 6.

To change the password, you will have to set it in the Password Setup Display (page 85).

Notes

- If you forget your password, you will have to reset it by selecting “Parental Control” of “Factory Setup” in “Options” setup (page 86).
- When you play discs which do not have the Parental Control function, playback cannot be limited on this recorder.
- Depending on the disc, you may be asked to change the Parental Control level while playing the disc. In this case, enter your password, then change the level.

Colour System

Selects the colour system when playing VIDEO CDs (including Super VIDEO CDs).

<u>PAL</u>	Plays a disc in PAL colour system.
NTSC	Plays a disc in NTSC colour system.

Screen Saver

The screen saver image appears when you do not use the recorder for more than 10 minutes while an on-screen display, such as the System Menu, is displayed on your TV screen. The screen saver image helps prevent your display device from becoming damaged (ghosting).

<u>On</u>	Turns on the screen saver function.
Off	Turns off the function.

Parental Control (Password)

This “Password” Setup allow you to set or to modify the password that gives access to Parental Control settings.

- 1** Press **SYSTEM MENU** while the recorder is in stop mode.
- 2** Select **“SETUP,”** and press **ENTER.**
- 3** Select **“Password,”** and press **ENTER.**
The Password Setup Display appears

- If you have not yet set a password, the display for registering a new password appears.

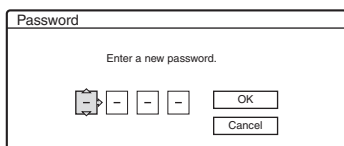

- When you have already registered a password, the display for entering the password appears.

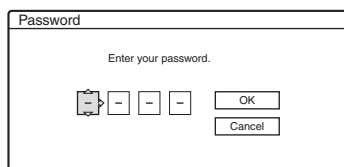

If you wish to change your password, first enter your current password using the number buttons, then select “OK” and press ENTER. The display for registering a new password appears.

- 4** Enter your new four-digit password using the number buttons, then select “OK” and press ENTER.

Note

If you forget your password, you will have to reset it by selecting “Parental Control” of “Factory Setup” in “Options” setup (page 86).

Disc and Remote Control Settings/Factory Settings (Options)

The “Options” setup allows you to set up other operational settings.

- 1** Press **SYSTEM MENU** while the recorder is in stop mode.
- 2** Select **“SETUP,”** and press **ENTER.**
- 3** Select **“Options,”** and press **ENTER.**
The “Options” setup appears with the following options. The default settings are underlined.

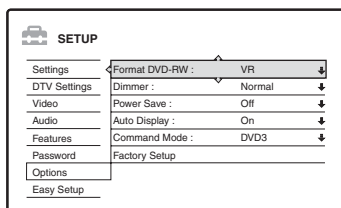

Format DVD-RW (DVD-RW only)

The recorder automatically starts formatting in VR mode or Video mode, whichever is selected below, when a new, unformatted DVD-RW is inserted.

<u>VR</u>	Automatically formats the disc in VR mode.
<u>Video</u>	Automatically formats the disc in Video mode.

Dimmer

Adjusts the lighting of the front panel display.

<u>Normal</u>	Bright lighting.
<u>Power Save</u>	Low lighting. Turns off the lighting when the power is off.

Note

When “Power Save” in “Options” setup is set to “On,” the front panel display is turned off during standby regardless of this setting.

Power Save

Selects whether this recorder is in power save mode when the power is turned off (standby).

On	Sets to power save mode. The front panel display is off when the recorder is in standby.
<u>Off</u>	Does not set to power save mode. Normally, select this.

Notes

- Power Save mode does not function when a Synchro Recording is set, even when “Power Save” is set to “On.”
- The SMARTLINK features are not available when “Power Save” is set to “On.”
- The  (Electronic Programme Guide) button located on the front panel is invalid when “Power Save” is set to “On” and the recorder is turned to off.

Auto Display

<u>On</u>	Automatically displays information on the screen when the recorder is turned on, etc.
Off	Displays information only when DISPLAY is pressed.

Command Mode

Changes the Command Mode of the recorder if other DVD equipment is assigned the same Command Mode. Be sure to match the Command Mode switch on the remote to the setting made here. For details, see “If you have a Sony DVD player or more than one Sony DVD recorder” on page 21.

DVD1	Select this if the default Command Mode conflicts with other DVD equipment.
DVD2	Select this if the default Command Mode conflicts with other DVD equipment.
<u>DVD3</u>	The default Command Mode of the recorder.

Factory Setup

Allows you to select the setup settings by group, and return them to their default settings. Note that all of your previous settings will be lost.

- 1 Select “Factory Setup” in “Options,” and press  or ENTER.

The display for selecting a group of settings appears.

- 2 Select the group of settings you want to return to default from “Settings,” “DTV Settings,” “Video,” “Audio,” “Features,” “Password,” “Options,” and “All,” and press  or ENTER.
- 3 Select “Start,” and press ENTER. The selected settings return to their default settings.
- 4 Press ENTER when “Finish” appears.

Easy Setup (Resetting the Recorder)

Select this to run the “Easy Setup” programme.

- 1** Press **SYSTEM MENU** while the recorder is in stop mode.
- 2** Select “**SETUP**,” and press **ENTER**.
- 3** Select “**Easy Setup**,” and press **ENTER**.

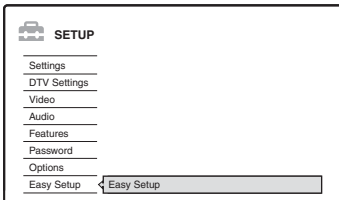

- 4** Press **ENTER**.
- 5** Select “**Start**.”
- 6** Follow the instructions for “**Easy Setup**” (page 22) from step 2.

Additional Information

Troubleshooting

If you experience any of the following difficulties while using the recorder, use this troubleshooting guide to help remedy the problem before requesting repairs. Should any problem persist, contact the Sony Customer Information Centre on

08705 111 999

(Monday-Friday from 8:30am to 6:00pm)

Power

The power does not turn on.

- ➔ Check that the mains lead is connected securely.

Tuner

The channel is not found or stored or missed.

- ➔ Make sure that your aerial is properly connected to the recorder.
- ➔ Confirm with your dealer that you are in an area that can receive a digital signal.
- ➔ Check your aerial installation.

Picture

There is no picture.

- ➔ Re-connect all connecting cords securely.
- ➔ The connecting cords are damaged.
- ➔ Check the connection to your TV (page 13).
- ➔ Switch the input selector on your TV (such as to "VCR") so that the signal from the recorder appears on the TV screen.
- ➔ Check that "Scart Setting" in "Video" setup is set to the appropriate item that conforms to your system (page 80).
- ➔ If you connect the recorder to your TV via only the COMPONENT VIDEO OUT jacks, set "Component Out" in "Video" setup to "On" (page 79).
- ➔ This recorder cannot record NTSC signals.
- ➔ A scrambled channel is selected.
- ➔ When playing a double-layer DVD, the video and audio may be momentarily interrupted at the point where the layers switch.

Picture noise appears.

- ➔ If the picture output signal from your recorder passes through your VCR to get to your TV, or if you are connected to a combination TV/VIDEO player, the copy-protection signal applied to some DVD programmes could affect picture quality. If you still experience this problem even when you connect your recorder directly to your TV, try connecting your recorder to your TV's S VIDEO input.
- ➔ You have set the recorder to progressive format (the PROGRESSIVE indicator lights up) even though your TV cannot accept the progressive signal. In this case, press PROGRESSIVE until the PROGRESSIVE indicator turns off.
- ➔ Even if your TV is compatible with progressive format (525p/625p) signals, the image may be affected when you set the recorder to progressive format. In this case, press PROGRESSIVE so that the PROGRESSIVE indicator turns off and the recorder is set to normal (interlace) format.
- ➔ You are playing a DVD recorded in a colour system that is different from your TV.
- ➔ When playing a double-layer DVD, the video and audio may be momentarily interrupted at the point where the layers switch.

TV programme reception does not fill the screen.

- ➔ Select the correct source using the INPUT SELECT button, or select a channel of any TV programme using the PROG +/- buttons.

Picture break up

- ➔ Signal strength low.
- ➔ Check aerial installation.

TV programme pictures are distorted.

- ➔ Reorient or upgrade the TV aerial.
- ➔ Adjust the picture (see the TV's instruction manual).
- ➔ Place the recorder and TV farther apart.
- ➔ Place the TV and any bunched aerial cables farther apart.
- ➔ The RF cable is connected to the AERIAL OUT jack on the recorder. Connect the cable to the AERIAL IN jack.

TV channels cannot be changed.

- ➔ The channel is hidden (page 77).
- ➔ A timer recording started, which changed the channels.
- ➔ The Parental Lock is activated (page 75).

The picture from equipment connected to the recorder's input jack does not appear on the screen.

- ➔ If the equipment is connected to the LINE 1 – TV jack, select “L1” in the front panel display by pressing PROG +/- or INPUT SELECT. If the equipment is connected to the LINE 2 IN jacks, select “L2” in the front panel display by pressing PROG +/- or INPUT SELECT. If the equipment is connected to the LINE 4 IN jacks, select “L4” in the front panel display by pressing PROG +/- or INPUT SELECT. If the equipment is connected to the LINE 3 jack, select “L3” in the front panel display by pressing PROG +/- or INPUT SELECT.
- ➔ When an S video cable is connected to the recorder's LINE 4 IN jack, set “Line4 Input” in “Video” setup to “S Video” (page 80).

The playback picture or TV programme from the equipment connected through the recorder is distorted.

- ➔ If the playback picture output from a DVD player, VCR, or tuner goes through your recorder before reaching your TV, the copy-protection signal applied to some programmes could affect picture quality. Disconnect the playback equipment in question and connect it directly to your TV.

The picture does not fill the screen.

- ➔ Set “TV Type” in “Video” setup in accordance with the screen size of your TV (page 79).

The picture does not fill the screen, even though the picture size is set in “TV Type” in “Video” setup.

- ➔ The picture size of the title is fixed.

The picture is black and white.

- ➔ Check that “Line1 Output” of “Scart Setting” in “Video” setup is set to the appropriate item that conforms to your system (page 80).
- ➔ If you are using a SCART cord, be sure to use one that is fully wired (21 pins).

Sound

There is no sound.

- ➔ Re-connect all connections securely.
- ➔ The connecting cord is damaged.
- ➔ The input source setting on the amplifier or the connection to the amplifier is incorrect.
- ➔ The recorder is in reverse play, fast-forward, slow motion, or pause mode.
- ➔ If the audio signal does not come through the DIGITAL OUT (OPTICAL or COAXIAL) jacks, check the “Audio Connection” settings in “Audio” setup (page 81).
- ➔ A scrambled channel is selected.

Sound distortion occurs.

- ➔ Set “Audio ATT” in “Audio” setup to “On” (page 81).

Sound is noisy.

- ➔ When playing a CD with DTS sound tracks, noise will come from the LINE 2 OUT R-AUDIO-L jacks, LINE 1 – TV jack, or LINE 3 jack (page 59).

The sound volume is low.

- ➔ The sound volume is low on some DVDs. The sound volume may improve if you set “Audio DRC” in “Audio” setup to “TV Mode” (page 81).
- ➔ Set “Audio ATT” in “Audio” setup to “Off” (page 81).
- ➔ One of the Surround TVS effects is selected (page 60).

An alternate audio track cannot be recorded.

- ➔ When recording from connected equipment, set “Line Audio Input” in TOOLS menu to “Bilingual” (page 55).
- ➔ Any discs other than DVD-RWs (VR mode) cannot be used for recording both main and sub sounds.
- ➔ If you have connected an AV amplifier to the DIGITAL OUT (OPTICAL or COAXIAL) jacks and want to change the audio track for a DVD-RW (VR mode) during playback, set “Dolby Digital” of “Audio Connection” in “Audio” setup to “D-PCM” (page 82).

Sound break up

- ➔ Signal strength low.
- ➔ Check aerial installation.

Playback

The recorder does not play any type of disc.

- ➔ The disc is upside down. Insert the disc with the labelled side facing up.
- ➔ The disc is not correctly inserted.
- ➔ Moisture has condensed inside the recorder. Remove the disc and leave the recorder turned on for about half an hour until the moisture evaporates.
- ➔ If the disc was recorded on another recorder, the recorder cannot play the disc if it was not finalised (page 36).

The recorder does not start playback from the beginning.

- ➔ Resume play was activated (page 57).
- ➔ You have inserted a DVD whose Title menu or DVD menu automatically appears on the TV screen when it is first inserted. Use the menu to start playback.

The recorder starts playing automatically.

- ➔ The DVD VIDEO features an auto playback function.

Playback stops automatically.

- ➔ If the DVD has an auto pause signal, the recorder stops playback at the auto pause signal.

Some functions such as Stop, Search, or Slow-motion Play cannot be performed.

- ➔ Depending on the DVD, you may not be able to do some of the operations above. See the instruction manual supplied with the disc.

The language for the sound track cannot be changed.

- ➔ Multilingual tracks are not recorded on the DVD being played.
- ➔ The DVD VIDEO prohibits the changing of the language for the sound track.
- ➔ Try changing the language using the DVD VIDEO's menu.

The subtitle language cannot be changed or turned off.

- ➔ Multilingual subtitles are not recorded on the DVD VIDEO.
- ➔ The DVD VIDEO prohibits changing of the subtitles.

- ➔ Try changing the subtitle using the DVD VIDEO's menu.
- ➔ The subtitles cannot be changed for the titles recorded on this recorder.

The angles cannot be changed.

- ➔ Multi-angles are not recorded on the DVD VIDEO being played.
- ➔ You are trying to change the angles when “” does not appear on the TV screen (page 58).
- ➔ The DVD VIDEO prohibits changing angles.
- ➔ Try changing the angle using the DVD VIDEO's menu.
- ➔ The angles cannot be changed for the titles recorded on this recorder.

The MP3 audio tracks do not play.

- ➔ The MP3 audio tracks are not recorded in a format that the recorder can play (page 65).

The JPEG image files do not play.

- ➔ The JPEG image files are not recorded in a format that the recorder can play (page 65).
- ➔ Progressive JPEG images cannot be played.

Recording/Timer recording/ Editing

The programme position cannot be changed from the programme position you are recording.

- ➔ Set the TV's input source to “TV.”

Recording does not start immediately after you press ● REC.

- ➔ Operate the recorder only after “LOAD,” “FORMAT,” or “INFOWRITE” disappears from the front panel display.

Nothing was recorded even though you set the timer setting correctly.

- ➔ There was a power failure during recording.
- ➔ The recorder's internal clock stopped due to a power failure that lasted for more than 1 hour. Reset the clock (page 74).
- ➔ The channel was hidden after the timer recording was set. See “Programme Hide” on page 77.
- ➔ Disconnect the mains lead from the mains, and connect it again.
- ➔ The programme contains copy protection signals that restrict copying.

- ➔ Other timer setting overlapped the timer setting (page 53).
- ➔ There is no DVD inside the recorder.
- ➔ There is not enough disc space for the recording.
- ➔ A scrambled channel is selected.
- ➔ The Channel activated Parental Lock is selected.

Recording does not stop immediately after you press ■ REC STOP.

- ➔ It will take a few seconds for the recorder to input disc data before recording can stop.

Recording does not stop after you press ■.

- ➔ Open the remote's cover and press ■ REC STOP.

Timer recording is not complete or did not start from the beginning.

- ➔ There was a power failure during recording. If the power recovers when there is a timer recording, the recorder resumes recording. Should the power failure continue for more than 1 hour, reset the clock (page 74).
- ➔ Other timer setting overlapped the timer setting (page 53).
- ➔ Disc space was not enough.

Contents previously recorded were erased.

- ➔ Data that has been recorded on a DVD with a PC will be erased from the disc when the disc is inserted.

Recording from the equipment with a timer

Nothing was recorded even though you set the Synchro-Rec setting correctly.

- ➔ You forgot to turn off the connected equipment. Turn off the connected equipment and set the recorder to Synchro-Rec standby mode (page 54).
- ➔ The recorder was not set to the Synchro-Recording standby mode. Press SYNCHRO REC to have the recorder stand by for recording. Make sure the SYNCHRO REC indicator lights up on the front panel (page 54).
- ➔ The recorder is connected to the TV output jack of the connected equipment.

Synchro-Recording does not complete.

- ➔ The timer setting for the connected equipment overlapped the recorder's timer setting (page 55).
- ➔ There was a power failure during the recording.

The recorder automatically starts recording when the satellite receiver is turned on.

- ➔ The Synchro-Rec function was activated. Turn off the satellite receiver and cancel the Synchro-Rec function (page 54).

Display

The clock has stopped.

- ➔ Set the clock again (page 74).
- ➔ The clock stopped due to a power failure that lasted for more than 1 hour. Reset the clock (page 74).

The TIMER REC indicator is flashing.

- ➔ The disc does not have enough space.
- ➔ Insert a recordable disc inside the recorder.

The recording mode indication is incorrect.

- ➔ When the recording is less than three minutes, the recording mode indication may be displayed incorrectly. The actual recording itself is correctly made in the selected recording mode.
- ➔ After playing titles recorded in SLP and SEP mode, the recording mode indication may change depending on the recorded programme.

The clock does not appear in the front panel display.

- ➔ "Dimmer" in "Options" setup is set to "Power Save" (page 85).
- ➔ The "Power Save" in "Options" setup was set to "On," and the recorder is in standby (page 86).

Remote control

The remote does not function.

- ➔ Batteries are weak.
- ➔ The remote is too far from the recorder.
- ➔ The remote's manufacturer code returned to the default setting when you replaced the batteries. Reset the code (page 19).
- ➔ Turn on the recorder.

- ➔ The remote is not pointed at the remote sensor on the recorder.
- ➔ Different command modes are set for the recorder and remote. Set the same command mode (page 21). The default command mode setting for this recorder and the supplied remote is DVD3.
- ➔ Set the TV/DVD switch to DVD (page 20).

Other Sony equipment responds to the remote.

- ➔ The same command mode is set for both the equipment and recorder. Set a different command mode for the recorder (page 21).

Others

The recorder does not operate properly.

- ➔ Restart the recorder. Press down **I/⏻** on the recorder for more than ten seconds until “WELCOME” appears in the front panel display.
- ➔ When static electricity, etc., causes the recorder to operate abnormally, turn off the recorder and wait until the clock appears in the front panel display. Then, unplug the recorder and after leaving it off for a while, plug it in again.

Five numbers or letters are displayed in the front panel display.

- ➔ The self-diagnosis function was activated (see the table on page 93).

The disc tray does not open after you press **⏻ (open/close).**

- ➔ It may take a few seconds for the disc tray to open after you have recorded or edited a DVD. This is because the recorder is adding disc data to the disc.

The disc tray does not open and “TRAY LOCKED” appears in the front panel display.

- ➔ Contact your Sony dealer or local authorized Sony service facility.

“RECOVERY” appears in the front panel display.

- ➔ The recorder’s recovery function was activated when the recorder was turned on because the power was turned off or failed during recording. Leave the recorder on until “RECOVERY” disappears from the front panel display.

“FAN ERROR” appears in the front panel display.

- ➔ Check that the vent on the rear of the recorder is not blocked. Then, immediately disconnect the mains lead. Leave the recorder off for a while, then re-connect the mains lead, and press **I/⏻** on the recorder.

The Parental Lock does not work.

- ➔ Check the Parental Lock options settings (page 75).

Mechanical sound is heard when the recorder is off.

- ➔ While the recorder is updating the EPG information, operational noises (such as the internal fan) may be heard, even when the power is off. This is not a malfunction.

The disc tray does not open and you cannot remove the disc after you press **⏻ (open/close).**

- ➔ Turn off the recorder. Once the clock appears in the front panel display, disconnect the mains lead. (If the recorder does not turn off or if the clock does not appear in the front panel display, disconnect the mains lead anyway.) Connect the mains lead again while pressing down **⏻** on the recorder, and release the button when the disc tray opens. Then, keep **I/⏻** on the recorder pressed for about ten seconds until “WELCOME” appears in the front panel display.

“LOCKED” appears in the front panel display.

- ➔ The disc tray is locked. Cancel the Child Lock (page 57).

Self-diagnosis Function (When letters/numbers appear in the display)

When the self-diagnosis function is activated to prevent the recorder from malfunctioning, a five-character service number (e.g., C 13 00) with a combination of a letter and four numbers appears in the front panel display. In this case, check the following table.

First three characters of the service number	Cause and/or corrective action
C 13	The DVD is dirty. ➔ Clean the disc with a soft cloth.
C 31	The DVD/CD is not inserted correctly. ➔ Re-insert the disc correctly.
E XX (xx is a number)	To prevent a malfunction, the recorder has performed the self-diagnosis function. ➔ Contact your nearest Sony dealer or local authorized Sony service facility and give the five-character service number. Example: E 61 10

Notes About This Recorder

On operation

- If the recorder is brought directly from a cold to a warm location, or is placed in a very damp room, moisture may condense on the lenses inside the recorder. Should this occur, the recorder may not operate properly. In this case, remove the disc and leave the recorder turned on for about half an hour until the moisture evaporates.
- When you move the recorder, take out any discs. If you don't, the disc may be damaged.

On adjusting volume

Do not turn up the volume while listening to a section with very low level inputs or no audio signals. If you do, the speakers may be damaged when a peak level section is played.

On cleaning

Clean the cabinet, panel, and controls with a soft cloth slightly moistened with a mild detergent solution. Do not use any type of abrasive pad, scouring powder or solvent such as alcohol or benzine.

On cleaning discs

Do not use a commercially available cleaning disc. It may cause a malfunction.

Notes about the discs

- To keep the disc clean, handle the disc by its edge. Do not touch the surface. Dust, fingerprints, or scratches on the disc may cause it to malfunction.



- Do not expose the disc to direct sunlight or heat sources such as hot air ducts, or leave it in a car parked in direct sunlight as the temperature may rise considerably inside the car.
- After playing, store the disc in its case.

- Clean the disc with a cleaning cloth. Wipe the disc from the centre out.



- Do not use solvents such as benzine, thinner, commercially available disc/lens cleaners, or anti static spray intended for vinyl LPs.
- Do not use the following discs.
 - A disc that has a non-standard shape (e.g., card, heart).
 - A disc with a label or sticker on it.
 - A disc that has cellophane tape or sticker adhesive on it.

Specifications

System

Laser: Semiconductor laser

Transmission standards: DVB-T



Channel coverage: UHF channels B21 - B69

The above channel coverage merely ensures the channel reception within these ranges. It does not guarantee the ability to receive signals in all circumstances.

Aerial out: 75-ohm asymmetrical aerial socket

Video recording format: MPEG Video

Audio recording format/applicable bit rate: Dolby Digital 2 ch/256 kbps

Inputs and outputs

LINE 2 OUT

(AUDIO): Phono jack/2 V_{rms}/10 kilohms

(VIDEO): Phono jack/1.0 V_{p-p}

(S VIDEO): 4-pin mini DIN/Y: 1.0 V_{p-p},
C: 0.3 V_{p-p} (PAL)

LINE 2 IN/LINE 4 IN

(AUDIO): Phono jack/2 V_{rms}/more than
22 kilohms

(VIDEO): Phono jack/1.0 V_{p-p}

(S VIDEO): 4-pin mini DIN/Y: 1.0 V_{p-p},
C: 0.3 V_{p-p} (PAL)

LINE 1 – TV: 21-pin

CVBS IN/OUT

S-Video/RGB OUT (upstream)

LINE 3: 21-pin

CVBS IN/OUT

S-Video/RGB IN

S-Video OUT (downstream)

DIGITAL OUT (OPTICAL): Optical output jack/
–18 dBm (wave length: 660 nm)

DIGITAL OUT (COAXIAL): Phono jack/
0.5 V_{p-p}/75 ohms

COMPONENT VIDEO OUT

(Y, P_B/C_B, P_R/C_R):

Phono jack/Y: 1.0 V_{p-p}, P_B/C_B: 0.7 V_{p-p},

P_R/C_R: 0.7 V_{p-p}

General

Power requirements: 220-240 V AC, 50/
60 Hz

Power consumption: 35 W

Dimensions (approx.): 430 × 75 × 328 mm
(width/height/depth) incl. projecting parts

Mass (approx.): 4.4 kg

Operating temperature: 5°C to 35°C

Operating humidity: 25% to 80%

Supplied accessories:

Audio/video cord (1)

Mains lead (1)

Aerial cable (1)

Remote commander (remote) (1)

R6 (size AA) batteries (2)

Specifications and design are subject to change without notice.

Compatible colour systems

This recorder is designed to record using the PAL colour system and play back using the PAL or NTSC colour systems.

Guide to Parts and Controls

For more information, see the pages in parentheses.

Remote

Buttons with an orange dot next to them can be used with your TV when the TV/DVD switch is set to TV.

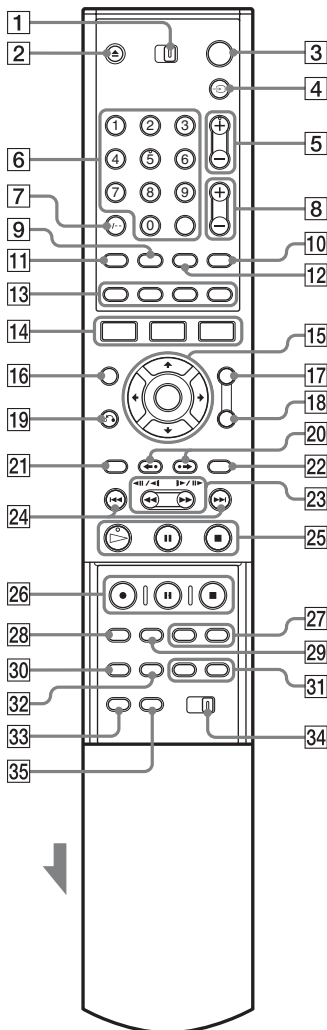

- 1 TV/DVD switch (19)
- 2 (open/close) button (26)
- 3 (on/standby) button (22)
- 4 TV/VIDEO, TV/DVD button (19)
- 5 PROG (programme) +/- buttons (28)
The + button has a tactile dot*.
- 6 Number buttons (48, 62)
SET button (48)
The number 5 button has a tactile dot*.
- 7 CLEAR/-/- (ten digit) button (48)
- 8 (volume) +/- buttons (19)
- 9 Text button (42)
- 10 TV/RADIO button (42)
- 11 (audio) button (58)
The button has a tactile dot*.
- 12 [TIMER] button (46)
- 13 Coloured multimedia applications & interactive services control buttons (38)
- 14 SYSTEM MENU button (21, 74)
TITLE LIST button (29, 56, 63, 68)
 GUIDE (Electronic Programme Guide) button (38, 48)
- 15 /ENTER button (22)
- 16 INFO button (40)
- 17 Favourite button (43)
- 18 TOOLS button (26)
- 19 RETURN button (52)
- 20 (instant replay)/ (instant advance) buttons (29, 63)
- 21 TOP MENU button (56)
- 22 MENU button (56)
- 23 (search) buttons (58)
- 24 (previous/next) buttons (58)

- 25 ▷ (play) button (56)
- (pause) button (58)
- (stop) button (56)
- The ▷ button has a tactile dot*.

- 26 ● REC button (28)
- REC PAUSE button (28)
- REC STOP button (28)

- 27 CHAPTER MARK/CHAPTER MARK ERASE buttons (71)

- 28 REC MODE button (28)

- 29 SYNCHRO REC button (54)

- 30 ⋯ (subtitle) button (58)

- 31 DISPLAY button (31)
- TIME/TEXT button (31)

- 32 ∞ (angle) button (58)

- 33 INPUT SELECT button (55)

- 34 COMMAND MODE switch (DVD 1,2,3) (21)

- 35 PROGRESSIVE button (16)

* Use the tactile dot as a reference when operating the recorder.

Front panel

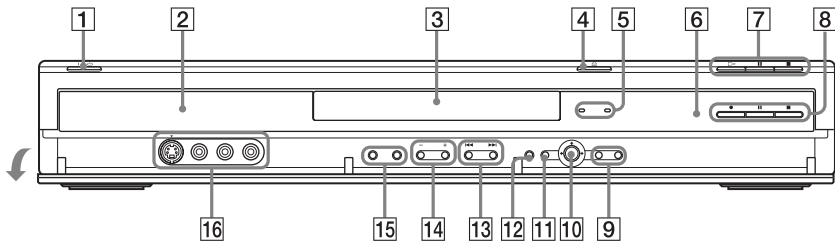

- 1 I/⏻ (on/standby) button (22)
- 2 Front panel display (32, 98)
- 3 Disc tray (26)
- 4 ⏏ (open/close) button (26)
- 5 TIMER REC indicator (46)
- SYNCHRO REC indicator (54)

- 6 📡 (remote sensor) (19)

- 7 ▷ (play) button (56)
- (pause) button (58)
- (stop) button (56)

- 8 ● REC button (28)
- REC PAUSE button (28)
- REC STOP button (28)

- 9 SYSTEM MENU button (21)
- TOOLS button (26)

- 10 ⬅/⬆/⬇/⬅/➡/ENTER button (22)

- 11 ↶ RETURN button (22)

- 12 📖 GUIDE (Electronic Programme Guide) button (38)

- 13 ⏮/⏭ (previous/next) buttons (58)

- 14 PROGRAM +/- buttons (28)
- The + button has a tactile dot*.

- 15 REC MODE button (45)
- INPUT SELECT button (55)

- 16 LINE 2 IN (S VIDEO/VIDEO/L(MONO) AUDIO R) jacks (24)

* Use the tactile dot as a reference when operating the recorder.

Front panel display

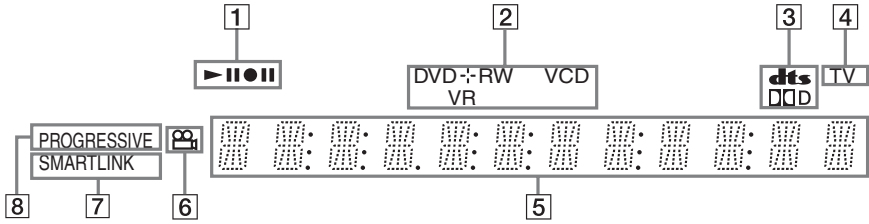

- 1** Playing/recording status
- 2** Disc type*/recording format
- 3** Audio signal indicators (31)
- 4** TV indicator (28)
- 5** Displays the following (32):
 - Playing time/remaining time
 - Current title/chapter/track/index number
 - Recording time/recording mode
 - Clock
 - Programme position
 - TV Direct Rec indication (28): “TV” appears in the right most two digits.
- 6** ∞ (angle) indicator (58)
- 7** SMARTLINK indicator (15)
- 8** PROGRESSIVE indicator (16)

* Displays DATA CDs as “CD.”

Hint

You can turn off the front panel display when the recorder is turned off by setting “Dimmer” to “Power Save” in “Options” setup (page 85).

Rear panel

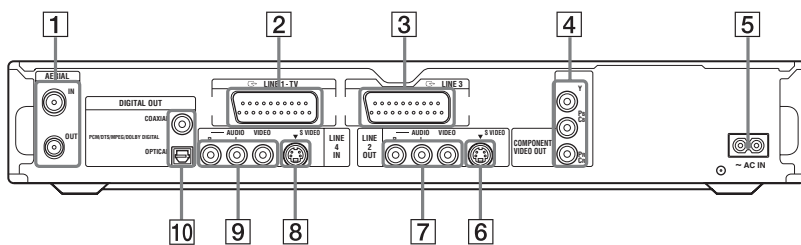

- 1** AERIAL IN/OUT jacks (13)
- 2** LINE 1 – TV jack (14)
- 3** LINE 3 jack (23)
- 4** COMPONENT VIDEO OUT (Y, Pb/Cb, Pr/Cr) jacks (14)
- 5** AC IN terminal (18)
- 6** LINE 2 OUT (S VIDEO) jack (14)
- 7** LINE 2 OUT (R-AUDIO-L/VIDEO) jacks (14, 17)
- 8** LINE 4 IN (S VIDEO) jack (24)
- 9** LINE 4 IN (R-AUDIO-L/VIDEO) jacks (24)
- 10** DIGITAL OUT (COAXIAL/OPTICAL) jacks (17)

Glossary

Chapter (page 62)

Sections of a picture or a music feature that are smaller than titles. A title is composed of several chapters. Depending on the disc, no chapters may be recorded.

Copy protection signals (page 45)

Copy restriction set by copyright owners, etc. These signals are included in some software or TV programmes and restrict recording on this recorder.

Dolby Digital (page 82)

Digital audio compression technology developed by Dolby Laboratories. This technology conforms to multi-channel surround sound. The rear channel is stereo and there is a discrete subwoofer channel in this format. Dolby Digital provides the same discrete channels of high quality digital audio found in “Dolby Digital” theater surround sound systems.

Good channel separation is realized because all of the channel data is recorded discretely, and little deterioration occurs because all channel data processing is digital.

DTS (page 82)

Digital audio compression technology by Digital Theater Systems, Inc. This technology conforms to multi-channel surround sound. The rear channel is stereo and there is a discrete subwoofer channel in this format. DTS provides the same discrete channels of high quality digital audio.

Good channel separation is realized because all of the channel data is recorded discretely, and little deterioration occurs because all channel data processing is digital.

DVD+R (page 8)

A DVD+R (read “plus R”) is a recordable disc that is the same size as a DVD VIDEO. Contents can be recorded only once to a DVD+R, and will have the same format as a DVD VIDEO.

DVD+RW (page 8)

A DVD+RW (read “plus RW”) is a recordable and rewritable disc. DVD+RWs use a recording format that is comparable to the DVD VIDEO format.

DVD-R (page 8)

A DVD-R is a recordable disc that is the same size as a DVD VIDEO. Contents can be recorded only once to a DVD-R, and will have the same format as a DVD VIDEO.

DVD-RW (page 8)

A DVD-RW is a recordable and rewritable disc that is the same size as a DVD VIDEO. The DVD-RW has two different modes: VR mode and Video mode. DVDs created in Video mode have the same format as a DVD VIDEO, while discs created in VR (Video Recording) mode allow the contents to be programmed or edited.

DVD VIDEO (page 10)

A disc that contains up to eight hours of moving pictures on a disc the same diameter as a CD. The data capacity of a single-layer and single-sided DVD is 4.7 GB (Giga Byte), which is 7 times that of a CD. The data capacity of a double-layer and single-sided DVD is 8.5 GB, a single-layer and double-sided DVD is 9.4 GB, and double-layer and double-sided DVD is 17 GB.

The picture data uses the MPEG 2 format, which is a worldwide standard of digital compression technology. The picture data is compressed to about 1/40 (average) of its original size. The DVD also uses a variable rate coding technology that changes the data to be allocated according to the status of the picture. Audio information is recorded in a multi-channel format, such as Dolby Digital, allowing you to enjoy a more real audio presence.

Furthermore, various advanced functions such as the multi-angle, multilingual, and Parental Control functions are provided on the DVD.

EPG (page 38)

The Electronic Programme Guide is a guide showing programmes which can be displayed on a conventional television (via the Digital Terrestrial Television tuner included in this recorder) as the now and next programmes or the television schedule for a day or more at a time.

Interlace format (page 16)

Interlace format shows every other line of an image as a single “field” and is the standard method for displaying images on television. The even number field shows the even numbered lines

of an image, and the odd numbered field shows the odd numbered lines of an image.

MPEG Audio (page 82)

International standard coding system used to compress audio digital signals authorized by ISO/IEC. MPEG 2, used on DVDs, conforms to up to 7.1-channel surround.

Original (page 67)

Titles actually recorded on a DVD-RW (VR mode). Erasing original titles frees up disc space.

Playlist (page 67)

Playback information created from the actual recordings on a DVD-RW (VR mode). A Playlist leaves the original titles as they are, and contains only the information needed to control playback. A Playlist title takes up very little disc space.

Progressive format (page 16)

Compared to the Interlace format that alternately shows every other line of an image (field) to create one frame, the Progressive format shows the entire image at once as a single frame. This means that while the Interlace format can show 25-30 frames/50-60 fields in one second, the Progressive format can show 50/60 frames in one second. The overall picture quality increases and still images, text, and horizontal lines appear sharper.

Title (page 62)

The longest section of a picture or music feature on a DVD, movie, etc., in video software, or the entire album in audio software.

Track (page 62)

Sections of a music feature on a CD/VIDEO CD (the length of a song).

Language Code List

For details, see page 74.

The language spellings conform to the ISO 639: 1988 (E/F) standard.

Code Language	Code Language	Code Language	Code Language
1027 Afar	1183 Irish	1347 Maori	1507 Samoan
1028 Abkhazian	1186 Scots Gaelic	1349 Macedonian	1508 Shona
1032 Afrikaans	1194 Galician	1350 Malayalam	1509 Somali
1039 Amharic	1196 Guarani	1352 Mongolian	1511 Albanian
1044 Arabic	1203 Gujarati	1353 Moldavian	1512 Serbian
1045 Assamese	1209 Hausa	1356 Marathi	1513 Siswati
1051 Aymara	1217 Hindi	1357 Malay	1514 Sesotho
1052 Azerbaijani	1226 Croatian	1358 Maltese	1515 Sundanese
1053 Bashkir	1229 Hungarian	1363 Burmese	1516 Swedish
1057 Byelorussian	1233 Armenian	1365 Nauru	1517 Swahili
1059 Bulgarian	1235 Interlingua	1369 Nepali	1521 Tamil
1060 Bihari	1239 Interlingue	1376 Dutch	1525 Telugu
1061 Bislama	1245 Inupiak	1379 Norwegian	1527 Tajik
1066 Bengali;	1248 Indonesian	1393 Occitan	1528 Thai
Bangla	1253 Icelandic	1403 (Afan)Oromo	1529 Tigrinya
1067 Tibetan	1254 Italian	1408 Oriya	1531 Turkmen
1070 Breton	1257 Hebrew	1417 Punjabi	1532 Tagalog
1079 Catalan	1261 Japanese	1428 Polish	1534 Setswana
1093 Corsican	1269 Yiddish	1435 Pashto;	1535 Tonga
1097 Czech	1283 Javanese	Pushto	1538 Turkish
1103 Welsh	1287 Georgian	1436 Portuguese	1539 Tsonga
1105 Danish	1297 Kazakh	1463 Quechua	1540 Tatar
1109 German	1298 Greenlandic	1481 Rhaeto-	1543 Twi
1130 Bhutani	1299 Cambodian	Romance	1557 Ukrainian
1142 Greek	1300 Kannada	1482 Kirundi	1564 Urdu
1144 English	1301 Korean	1483 Romanian	1572 Uzbek
1145 Esperanto	1305 Kashmiri	1489 Russian	1581 Vietnamese
1149 Spanish	1307 Kurdish	1491 Kinyarwanda	1587 Volapük
1150 Estonian	1311 Kirghiz	1495 Sanskrit	1613 Wolof
1151 Basque	1313 Latin	1498 Sindhi	1632 Xhosa
1157 Persian	1326 Lingala	1501 Sangho	1665 Yoruba
1165 Finnish	1327 Laothian	1502 Serbo-	1684 Chinese
1166 Fiji	1332 Lithuanian	Croatian	1697 Zulu
1171 Faroese	1334 Latvian;	1503 Singhalese	
1174 French	Lettish	1505 Slovak	
1181 Frisian	1345 Malagasy	1506 Slovenian	1703 Not specified

Area Code

For details, see page 83.

Code Area	Code Area	Code Area	Code Area
2044 Argentina	2165 Finland	2362 Mexico	2149 Spain
2047 Australia	2174 France	2376 Netherlands	2499 Sweden
2046 Austria	2109 Germany	2390 New Zealand	2086 Switzerland
2057 Belgium	2248 India	2379 Norway	2528 Thailand
2070 Brazil	2238 Indonesia	2427 Pakistan	2184 United
2079 Canada	2254 Italy	2424 Philippines	Kingdom
2090 Chile	2276 Japan	2436 Portugal	
2092 China	2304 Korea	2489 Russia	
2115 Denmark	2363 Malaysia	2501 Singapore	

Digital TV Channel List

Only the main transmitters are listed. For further details or updates refer to the web site http://www.bbc.co.uk/reception/transmitters/tv_trans/index.shtml

MAIN TRANSMITTERS	BBC	ITV&C4	SDN	MuxB	MuxC	MuxD
London & South East						
① Bluebell Hill	59	24	27	45	42	39
② Crystal Palace	25	22	32	28	34	29
③ Dover	68	61	55	58	57	60
④ Heathfield	34	29	48	47	54	51
⑤ Oxford	34	68	51	52	48	29
South - West						
⑥ Beacon Hill	52	61	58	54	56	64
⑦ Caradon Hill	34	31	48	21	24	27
⑧ Huntshaw Cross	54	58	61	64	53	57
⑨ Redruth	39	42	45	49	43	50
⑩ Stockland Hill	22	28	25	32	30	34
Channel Islands						
⑪ Fremont Point	No Digital Transmission					
South						
⑫ Hannington	50	43	40	46	44	41
⑬ Midhurst	56	65	62	59	64	60
⑭ Rowridge	23	28	30	32	26	33
West						
⑮ Mendip	59	55	62	65	56	67
East						
⑯ Sandy Heath	42	45	43	67	40	46
⑰ Sudbury	49	68	48	39	54	50
⑱ Tacolneston	63	60	53	58	61	64
Midlands (West)						
⑲ Ridge Hill	53	57	60	63	42	45
⑳ Sutton Coldfield	41	44	47	51	52	55
㉑ The Wrekin A	21	31	24	27	53	57
Midlands (East)						
㉒ Waltham	49	23	26	33	45	42
Northern Ireland						
㉓ Brougher Mountain	30	34	23	26	29	33
㉔ Divis	29	33	23	26	48	34
㉕ Limavady	67	58	53	57	60	63
North						
㉖ Belmont	30	48	68	66	60	57
㉗ Emley Moor	52	40	43	46	50	49
North-West						
㉘ Winter Hill	56	66	68	67	60	63
North-East						
㉙ Bilsdale	34	21	31	24	27	42
㉚ Caldbeck	25	23	26	39	45	42
㉛ Chatton	40	50	43	46	47	51
㉜ Pontop Pike	48	55	59	62	65	53
Scotland						
㉝ Angus	68	66	59	62	56	65
㉞ Black Hill	41	47	44	51	55	65
㉟ Sandale	No Digital Transmission					
㊱ Bressay	21	24	27	31	66	68
㊲ Craigkelly	33	29	23	26	42	39
㊳ Darvel	22	25	32	28	30	34
㊴ Durris	30	34	52	51	41	44
㊵ Eitshal	34	30	22	25	28	32
㊶ Keelylang Hill	48	52	41	44	47	51
㊷ Knock More	34	30	53	57	60	56
㊸ Rosemarkie	47	51	41	44	46	50
㊹ Rumster Forest	28	22	25	32	62	59
㊺ Selkirk	53	57	60	63	66	56
Wales						
㊻ Blaenplwyf	28	22	25	32	29	33
㊼ Carmel	55	65	59	62	68	66
㊽ Llanddona	50	54	58	61	64	46
㊾ Moel-y-Parc	54	58	61	64	30	34
㊿ Presely	47	51	39	42	45	49
① Wenvoe	30	34	40	50	43	46

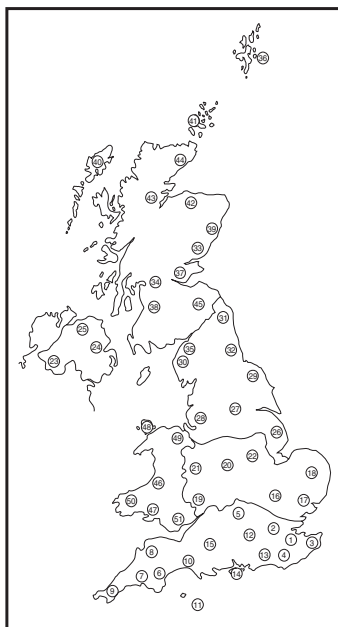

Index

Words in quotations appear in the on-screen displays.

Numerics

- 16:9 22, 79
- 4:3 Letter Box 22, 79
- 4:3 Pan Scan 22, 79
- “48kHz/96kHz PCM” 82

A

- “A-B Erase” 69
- Adjusting
 - playback picture 59
 - playback sound 60
 - recording picture 50
- Aerial 13
- Album 32, 66
- Album number 32
- “Album Search” 62
- Angle 58
- Area code 102
- Audio 58, 81
- “Audio Connection” 22
- Audio cord 17
- “Audio DRC” 81
- “Audio Filter” 60
- “Audio” 74
- “Audio Settings” 60
- “Auto Chapter” 83
- “Auto Display” 86
- Auto Tune 22, 76
- “AV SYNC” 60

B

- Batteries 19
- “Bilingual” 54, 55
- “BNR” 59
- “Brightness” 50, 59

C

- “C NR” 59
- “Capture All” 71
- “Capture” 71
- CD 10
- “Change IN” 72
- “Change OUT” 72
- Chapter 32, 51, 71, 100
- CHAPTER MARK 71
- CHAPTER MARK ERASE 71
- Chapter number 32
- “Chapter Search” 62
- Chasing Playback 61
- “Check Overlap” 52, 53
- Checking/changing/canceling timer settings (Timer List) 52
- Child Lock 57
- Cleaning discs 93
- Clock 22, 74
- “Colour” 50, 59
- “Colour System” 84
- Colour systems 95
- “Combine” 72
- “Command Mode” 21, 86
- “Component Out” 79
- Component video input 14
- COMPONENT VIDEO OUT 14
- Connecting 14
 - the aerial cable 13
 - the audio cords 17
 - the video cords 14
- “Contrast” 50, 59
- Controlling TVs with the remote 19
- Copy control signals 45
- Copy protection 100
- Copy-Free 45
- Copy-Never 45
- Copy-Once 45
- CPRM 8
- “Create Playlist” 71
- Creating chapters 71

D

- DATA CD 10
- “Digital Out” 82
- Digital Services
 - Digital Text viewing 41
 - EPG 38
 - Favourites 42
 - Index 44
 - Programme information 40
- Digital Software Upgrade 78
- “Dimmer” 85
- “Disc Info” 26, 35, 70
- Disc Map 70
- Disc Settings 26, 35, 70, 85
- Disc space 27
- Disc types 8
- Display
 - front panel display 32, 98
- Dolby Digital 17, 82, 100
- “Downmix” 81
- DTS 82, 100
- “DVD Menu” 74
- DVD VIDEO 10, 100
- DVD+R 8, 100
- DVD+RW 8, 100
- DVD-R 8, 100
- DVD-RW 8, 100
- DVD-RWs (Video mode) 68
- “DVE” 59

E

- Easy Setup 22, 87
- Editing 67, 71
- Enter characters 33
- EPG
 - Viewing a list of available channels 38
 - Viewing programmes related to a specific category. 39
- “Erase All” 70
- “Erase” 53, 68, 72
- “Erase Titles” 70
- “Extend Rec” 47

- F**
 “Factory Setup” 86
 Favourites
 Deleting a channel from the Favourites List 43
 Moving to a different favourite list 43
 Setting a favourite list 42
 Watching or listening to a favourite channel 43
 “Features” 83
 “File Search” 62
 “Finalise” 36
 Finalising 36
 “Format DVD-RW” 85
 “Format” 26
 Formatting 26
 Freeze Frame 58
 Front panel 97
 Front panel display 32, 98
- G**
 GB 27
- H**
 Handling discs 93
 “Hue” 59
- I**
 Index 44
 INPUT SELECT 55
 Interlace 101
 Interlace format 101
- J**
 JPEG image files 63
- L**
 Labelling 35
 Language 74
 LINE 2 IN 24
 LINE 3 23
 LINE 4 IN 24
 “Line Audio Input” 54, 55
 “Line Rec. Picture Size” 50
 “Line1 Output” 80
 “Line3 Input” 80
 “Line3 Output” 80
 “Line4 Input” 80
- M**
 Mains Lead 18
 Manual Clock Set 74
 Manufacturer Information 78
 MENU 56
 Menu
 DVD’s Menu 56
 Top menu 56
 “MNR” 59
 “Modify” 53
 “Move” 72
 MP3 audio tracks 63
 MPEG 82, 101
- N**
 Number buttons 34
- O**
 One Touch Menu 57
 One Touch Play 57
 One Touch Timer 47
 “Options” 85
 Original 30, 67, 101
- P**
 Page mode 30
 Parental Control 57, 83
 Parental Lock 75
 Parts and controls 96
 “Password” 85
 “Pause Mode” 79
 “PB Video Equalizer” 59
 PBC 56
 Picture quality 50, 59
 Picture size 50
 “Play Beginning” 57
 Play mode 32
 Playable discs 10
 Playback 10, 32, 56, 58
 fast forward 58
 fast reverse 58
 freeze frame 58
 instant advance 58
 instant replay 58
 JPEG image files 63
 MP3 audio tracks 63
 resume play 57
 slow-motion play 58
 Playing status bar 32
 Playlist 30, 67, 71, 101
 “Power Save” 86
 “Present Time” 74
 “Preview” 72
 Programme Hide 77
 Programme information 40
 Programme Sort 77
 Progressive 16, 101
 “Progressive Mode” 80
 “Protect Disc” 35
 “Protect” 68
 Protection
 disc 35
 title 68
- Q**
 Quick guide to disc types 8
 Quick Timer 49
- R**
 Rear panel 99
 REC 28
 Rec Mode Adjust 46
 “Rec Mode” 50
 “Rec NR” 50
 REC PAUSE 28
 “Rec Settings” 50
 “Rec Video Equalizer” 50
 Recordable discs 8
 Recording 54, 83
 picture adjustment 50
 recording format 8
 recording mode 29, 45
 recording time 29
 while watching another programme 28
 RECOVERY 92
 Region code 11
 Remaining time 32
 Remote 19, 96
 Resetting the recorder 87
 Resume Play 57
 “RGB” 22, 80

S

S VIDEO 14
“S Video” 22, 80
“Scart Setting” 80
Scene List 72
Screen Saver 84
“Search” 62
Searching
 fast reverse/fast forward 58
 locating the beginning of the title/chapter/track 58
 search mode 62
 visual search 62
SET 20, 34
“Set Thumbnail” 68
Signal Strength 78
Simultaneous Rec and Play 61
Slow-motion play 58
SMARTLINK 15
Sort 30
Sound quality 60
Subtitle 58, 74
Super VIDEO CD 10
Surround 60
Synchro Rec 54

T

Technical Information 78
Thumbnail picture 31
“Time Search” 62
TIME/TEXT 32
TIMER 46
Timer List 52
Timer recording
 check/change/cancel 51, 52
 EPG timer setting 48
 manual setting 46
 Rec Mode Adjust 46
 Synchro Rec 54
Title 32, 101
TITLE LIST 56
Title List 29, 56
 Sort 30
 Thumbnail 31
“Title Name” 68
Title number 32
“Title Search” 62

TOP MENU 56
Track 101
“Track Search” 62
Troubleshooting 88
“TV Direct Rec” 28, 83
“TV Type” 22, 79
TV/DVD switch 19
TV/VIDEO 28
TVS (TV Virtual Surround) 60

U

“Unfinalise” 37
Unfinalising 37
Usable discs 8, 10

V

VIDEO CD 10
Video cord 14
“Video” 22, 80, 79
Video input 14
Video mode 8
“Video Settings” 59
Visual Search 62
VR mode 8, 67

Y

“Y NR” 59



Printed on 100% recycled paper.



* I - 2 6 3 6 5 1 0 1 1 - *

2-636-510-11(3)