

Video Cassette Recorder/ DVD Recorder

Operating Instructions

RDR-VX410



WARNING

To reduce the risk of fire or electric shock, do not expose this apparatus to rain or moisture.
To avoid electrical shock, do not open the cabinet. Refer servicing to qualified personnel only.
The mains lead must only be changed at a qualified service shop.

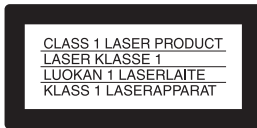

This appliance is classified as a CLASS 1 LASER product. The CLASS 1 LASER PRODUCT MARKING is located on the rear exterior.

CAUTION

The use of optical instruments with this product will increase eye hazard. As the laser beam used in this VCR-DVD recorder is harmful to eyes, do not attempt to disassemble the cabinet. Refer servicing to qualified personnel only.



This label is located on the laser protective housing inside the enclosure.

Notice for customers in the United Kingdom and Republic of Ireland

A moulded plug complying with BS1363 is fitted to this equipment for your safety and convenience. Should the fuse in the plug supplied need to be replaced, same rating fuse approved by ASTA or BSI to BS1362, (i.e., marked with ⚡ or ⚡ mark) must be used.
If the plug supplied with this equipment has a detachable fuse cover, be sure to attach the fuse cover after you change the fuse. Never use the plug without the fuse cover. If you should lose the fuse cover, please contact your nearest Sony service station.

Precautions

- This unit operates on 220 – 240 V AC, 50 Hz. Check that the unit's operating voltage is identical with your local power supply.
- To prevent fire or shock hazard, do not place objects filled with liquids, such as vases, on the apparatus.

VIDEO Plus+ and PlusCode are registered trademarks of Gemstar Development Corporation. The VIDEO Plus+ system is manufactured under license from Gemstar Development Corporation.

Disposal of Old Electrical & Electronic Equipment (Applicable in the European Union and other European countries with separate collection systems)



This symbol on the product or on its packaging indicates that this product shall not be treated as household waste.

Instead it shall be handed over to the applicable collection point for the recycling of electrical and electronic equipment. By ensuring this product is disposed of correctly, you will help prevent potential negative consequences for the environment and human health, which could otherwise be caused by inappropriate waste handling of this product. The recycling of materials will help to conserve natural resources. For more detailed information about recycling of this product, please contact your local Civic Office, your household waste disposal service or the shop where you purchased the product.

Precautions

On safety

Should any solid object or liquid fall into the cabinet, unplug the recorder and have it checked by qualified personnel before operating it any further.

On power sources

- The recorder is not disconnected from the AC power source (mains) as long as it is connected to the wall outlet, even if the recorder itself has been turned off.
- If you are not going to use the recorder for a long time, be sure to disconnect the recorder from the wall outlet. To disconnect the AC power cord (mains lead), grasp the plug itself; never pull the cord.

On placement

- Place the recorder in a location with adequate ventilation to prevent heat build-up in the recorder.
- If the recorder is brought directly from a cold to a warm location, or is placed in a very damp room, moisture may condense on the lenses inside the recorder and cause damage to the video head, tape, and the optical block. Should this occur, the recorder may not operate properly. When you first install the recorder, or when you move it from a cold to a warm location, remove the disc and tape and leave the recorder turned on for about three hours before operating the recorder.
- Do not place the recorder on a soft surface such as a rug that might block the ventilation holes.
- Do not place the recorder in a confined space such as a bookshelf or similar unit.
- Do not place the recorder in a location near heat sources, or in a place subject to direct sunlight, excessive dust, or mechanical shock.
- Do not place the recorder in an inclined position. It is designed to be operated in a horizontal position only.

- Keep the recorder, discs, and cassettes away from equipment with strong magnets, such as microwave ovens, or large loudspeakers.
- Do not place heavy objects on the recorder.
- When you move the recorder, take out any discs. If you do not, the disc may be damaged.

On recording

- Contents of the recording cannot be compensated for if the recording or playback is not made due to a malfunction of the recorder, disc, etc.
- Make trial recordings before making the actual recording.

Copyrights

- Television programmes, films, video tapes, discs, and other materials may be copyrighted. Unauthorized recording of such material may be contrary to the provisions of the copyright laws. Also, use of this recorder with cable television transmission may require authorization from the cable television transmitter and/or programme owner.
- This product incorporates copyright protection technology that is protected by U.S. patents and other intellectual property rights. Use of this copyright protection technology must be authorized by Macrovision, and is intended for home and other limited viewing uses only unless otherwise authorized by Macrovision. Reverse engineering or disassembly is prohibited.

Copy guard function

Since the recorder has a copy guard function, programmes received through an external tuner (not supplied) may contain copy protection signals (copy guard function) and as such may not be recordable, depending on the type of signal.











IMPORTANT NOTICE

Caution: This recorder is capable of holding a still video image or on-screen display image on your television screen indefinitely. If you leave the still video image or on-screen display image displayed on your TV for an extended period of time you risk permanent damage to your television screen. Plasma display panels and projection televisions are especially susceptible to this.

If you have any questions or problems concerning your recorder, please consult your nearest Sony dealer.

About this manual

- Instructions in this manual describe the controls on the remote. You can also use the controls on the recorder if they have the same or similar names as those on the remote.
- The on-screen display illustrations used in this manual may not match the graphics displayed on your TV screen.
- The explanations regarding discs in this manual refer to discs created on this recorder. The explanations do not apply to discs that are created on other recorders and played back on this recorder.

Icon	Meaning
	Functions available for DVD+RWs
	Functions available for DVD-RWs in VR (Video Recording) mode
	Functions available for DVD-RWs in video mode
	Functions available for DVD+Rs
	Functions available for DVD-Rs
	Functions available for DVD VIDEOS
	Functions available for VIDEO CDs, Super VCDs or CD-Rs/CD-RWs in video CD format or Super VCD format
	Functions available for music CDs or CD-Rs/CD-RWs in music CD format
	Functions available for DATA CDs (CD-Rs/CD-RWs containing MP3* audio tracks or JPEG image files)
	Functions available for DATA DVDs (DVD+RWs/DVD-RWs/DVD+Rs/DVD-Rs containing MP3* audio tracks or JPEG image files)
	Functions available for VHS VIDEOS

* MP3 (MPEG1 Audio Layer 3) is a standard format defined by ISO/MPEG which compresses audio data.

Table of Contents

WARNING	2
Precautions	2
What is a Video Cassette Recorder/DVD Recorder?	8
How to Use the On-Screen Menus	10

Hookups and Settings **12**

Hooking Up the Recorder	12
Step 1: Unpacking	12
Step 2: Connecting the Aerial Cable	13
Step 3: Connecting to Your TV	14
Step 4: Connecting to Your AV Amplifier (Receiver)	17
Step 5: Connecting the Mains Lead	19
Step 6: Preparing the Remote	19
Step 7: Easy Setup	22
Connecting Another VCR or Similar Device	26
Connecting to a Satellite or Digital Tuner	28

Quick Guide to Disc Types **30**

Recordable and Playable Discs	30
Playable Discs	32

DVD Operation

DVD Playback **34**

Playing	34
Playback Options	35
Playing a Title From the Title List	39
Searching for a Title/Chapter/Track, etc.	40
Playing MP3 Audio Tracks	42
Playing JPEG Image Files	43
Displaying the Playing Time and Play Information	45

DVD Recording **47**

Before Recording	47
DVD Recording Without the Timer	48
DVD Timer Recording (Standard/VIDEO Plus+)	50
Recording From Connected Equipment With a Timer (Synchro Rec)	54
Changing or Cancelling DVD Timer Settings (Timer List)	55
Recording From Connected Equipment Without a Timer	57

DVD Editing	58
Before Editing	58
Editing a Title	59
Changing the Name of a Title	63
Creating a Playlist	64
Editing a Playlist	65
Formatting/Renaming/Protecting a Disc	69

VCR Operation

VCR Playback	70
Playing	70
Playback Options	72
Searching Using Various Functions	73
Displaying the Playing Time and Play Information	74
Selecting the Sound During Playback	75

VCR Recording	76
Before Recording	76
VCR Recording Without the Timer	77
VCR Timer Recording (Standard/VIDEO Plus+)	79
Recording From Connected Equipment With a Timer (Synchro Rec)	82
Changing or Cancelling VCR Timer Settings (Timer List)	84
Recording From Connected Equipment Without a Timer	85

Dubbing (TAPE ↔ DVD)	87
Dubbing From a VHS Tape to a DVD	87
Dubbing From a DVD to a VHS Tape	88
Finalizing a Disc (Preparing a Disc for Playback on Other Equipment)	91

DV Dubbing (DV → DVD)	93
Before DV Dubbing	93
Connecting a Digital Video Camera to the DV IN Jack	93
Dubbing From a DV Format Tape to a DVD	94

Settings and Adjustments	97
Using the Setup Displays	97
Aerial Reception Setting (Tuner Preset)	98
Clock Setting (Clock Set)	100
Video Settings (Video)	101
Audio Settings (Audio)	103
Recording and VCR Settings (Features)	105
Language, Parental Control Settings/Factory Settings (Options)	106
Easy Setup (Resetting the Recorder)	108

Additional Information	109
Troubleshooting	109
Notes About This Recorder	114
Specifications	115
About i.LINK	117
Guide to Parts and Controls	118
Glossary	123
DVD Audio/Subtitle Language	124
Index	125

What is a Video Cassette Recorder/DVD Recorder?

This is a DVD recorder with built-in VHS video deck, and allows recording/playback of DVD discs and VHS tapes. DVD editing is also possible.

Recording and timer recording

Record TV programmes on a DVD or VHS tape, either manually or using the timer.

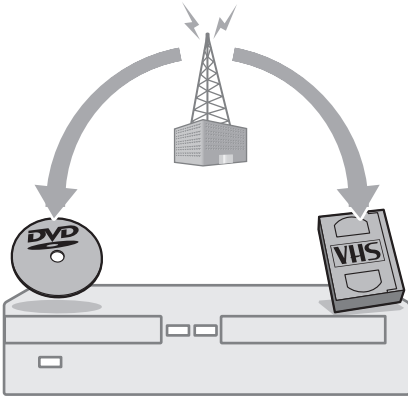

Easy dubbing

Dub in either direction between a DVD disc and VHS tape with the simple press of a button.

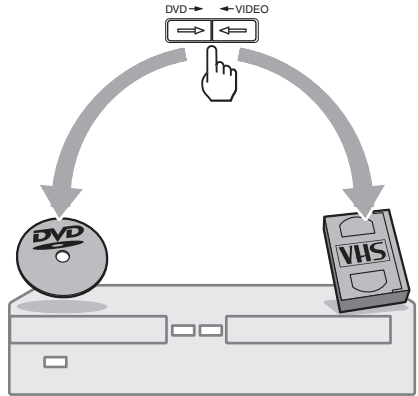

* Note that copy-protected signals will not be recorded.

Easy selection between DVD and VCR

Simply press the DVD or VIDEO button to select the media format you want to use.

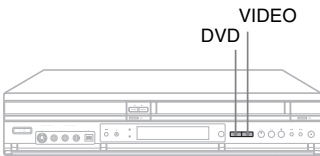
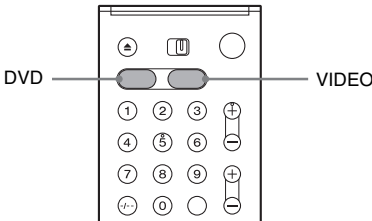

Quick access to recorded titles - Title List

Display the Title List to view all titles on a disc and select a title for playback or editing.

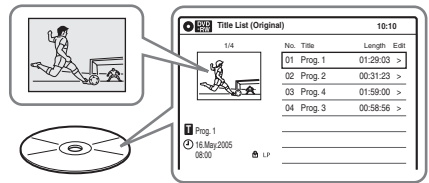

Creating your own programme - Playlist

Record a programme on a DVD-RW (VR mode), then erase, move, or add scenes as you like without changing the original contents.

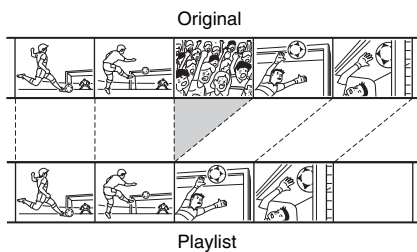

One Touch Dubbing - DV Dubbing

Connect your digital video camera to the DV IN jack and press the ONE TOUCH DUBBING button to dub a DV format tape over to a disc.

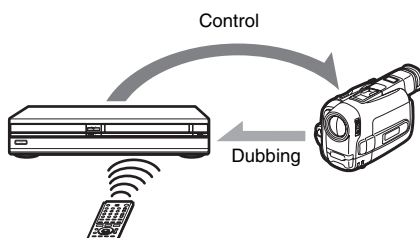

Operation restrictions

Current Operation	Possible Simultaneous Operations			
	VCR Playback	VCR Recording	DVD Playback	DVD Recording
Playing a VHS tape ^{*1}	—	No	No	Yes
Recording on a VHS tape	No	—	Yes	Yes ^{*3}
Playing a DVD ^{*2}	No	Yes	—	No
Recording on a DVD	Yes	Yes ^{*3}	No	—

^{*1} When DVD is pressed, VCR playback stops.

^{*2} When VIDEO is pressed, DVD playback stops.

^{*3} Only the same programme can be recorded on a DVD and a VHS tape.

How to Use the On-Screen Menus

The following three displays are mainly used to operate this recorder. Once you become familiar with the basic operations, you will find the recorder easy to use.

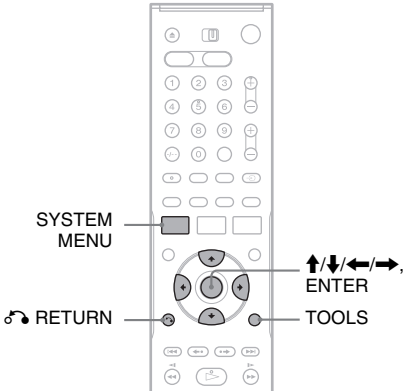

System Menu

The System Menu appears when you press SYSTEM MENU, and provides entries to all of the recorder's main functions, such as timer recording and setup.

Select an option by pressing **↑/↓** and ENTER.

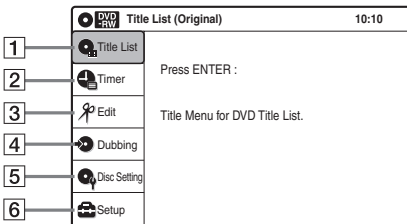

1 "Title List"

Displays the list of the disc contents, including the recording information and movie thumbnail image, which allows you to select a title to play or edit.

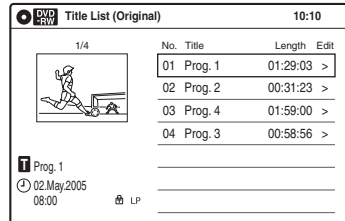

2 "Timer"

Used to set a new timer recording for a disc or VHS tape, as well as change or cancel the timer recordings you set.

3 "Edit"

Used to create or edit a Playlist (unfinalized DVD-RWs (VR mode) only).

4 "Dubbing"

Used to dub from a disc to a VHS tape and vice versa, and also dub from a DV format tape to a disc.

5 "Disc Setting"

Used to rename, format, or finalize a disc.

6 "Setup"

Displays the "Setup" display for setting up the recorder to suit your preferences.

Sub-menu

The sub-menu appears when you select an item from a list menu (e.g., a title from the Title List menu), and press ENTER. The sub-menu displays options applicable only to the selected item. The displayed options differ depending on the situation and disc type.

Select an option by pressing \uparrow/\downarrow and ENTER.

Example: The Title List menu

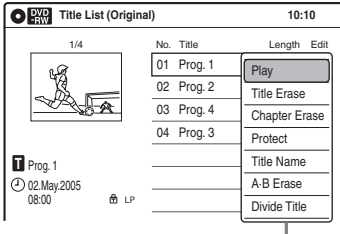

Options for the selected item

TOOLS

The TOOLS menu appears when you press TOOLS. You can search for a title/chapter/track, check the playing and remaining time, or change audio and repeat settings. The displayed options differ depending on the media type.

Press \uparrow/\downarrow to select an option, press \leftarrow/\rightarrow to select the desired item, and press ENTER.

Example: When you press TOOLS while a DVD-RW (VR mode) is playing.

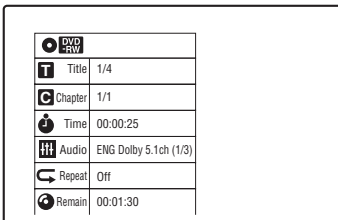

Selectable options

Selectable options on the System Menu differ depending on the media type, disc condition, and operating status.

Example: When a disc or a VHS tape is stopped.

Type	Selectable option
+RW	
-RWVR	
-RWVideo	
+R	
-R	
DVD	
VCD	
CD	
DATA CD	
DATA DVD	
VHS	

*1 Unfinalized disc only

*2 With a disc inserted

To return to the previous display

Press δ RETURN.

Notes

- The TOOLS menu may not appear during DVD recording.
- The System Menu does not appear during recording or dubbing.
- You cannot use the DVD or VIDEO buttons with the System Menu turned on.

Hooking Up the Recorder

Follow steps 1 to 7 to hook up and adjust the settings of the recorder.

Notes

- Plug cords securely to prevent unwanted noise.
- See the instructions supplied with the components to be connected.
- You cannot connect this recorder to a TV that does not have a SCART or video input jack.
- Be sure to disconnect the mains lead of each component before connecting.

Step 1: Unpacking

Check that you have the following items:

- Audio/video cord
(phono plug × 3 ↔ phono plug × 3) (1)
- Aerial cable (1)
- Remote commander (remote) (1)
- R6 (size AA) batteries (2)

Step 2: Connecting the Aerial Cable

Connect the aerial cable by following the steps below. Do not connect the mains lead until you reach “Step 5: Connecting the Mains Lead” (page 19).

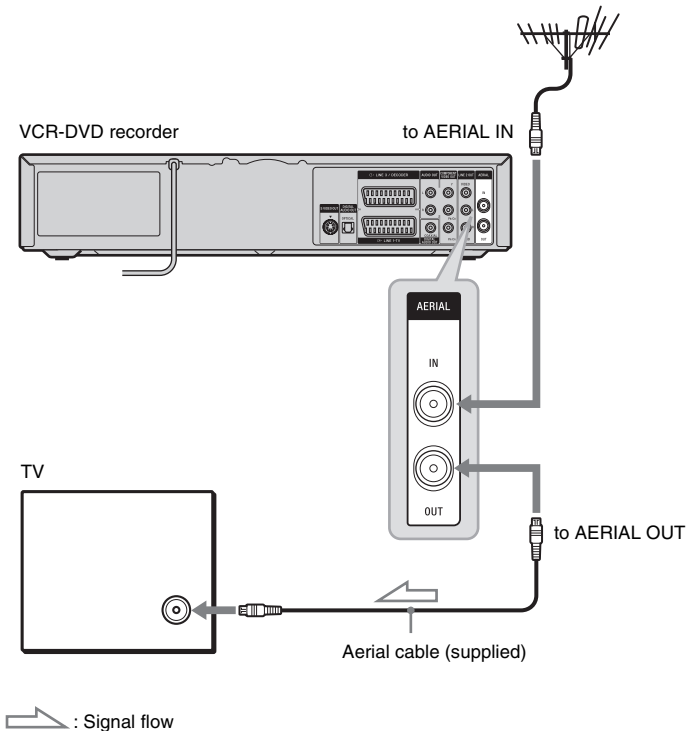

- 1** Disconnect the aerial cable from your TV and connect it to **AERIAL IN** on the rear panel of the recorder.
- 2** Connect **AERIAL OUT** of the recorder to the aerial input of your TV, using the supplied aerial cable.

Step 3: Connecting to Your TV

Connecting to the LINE 2 OUT jacks

Connect the supplied audio/video cord to the LINE 2 OUT (VIDEO/AUDIO L/R) jacks of the recorder. To enjoy higher quality images, connect an S video cord (not supplied) instead of the yellow (video) plug. When using this connection, be sure to connect the audio cord to the LINE 2 OUT (AUDIO L/R) jacks.

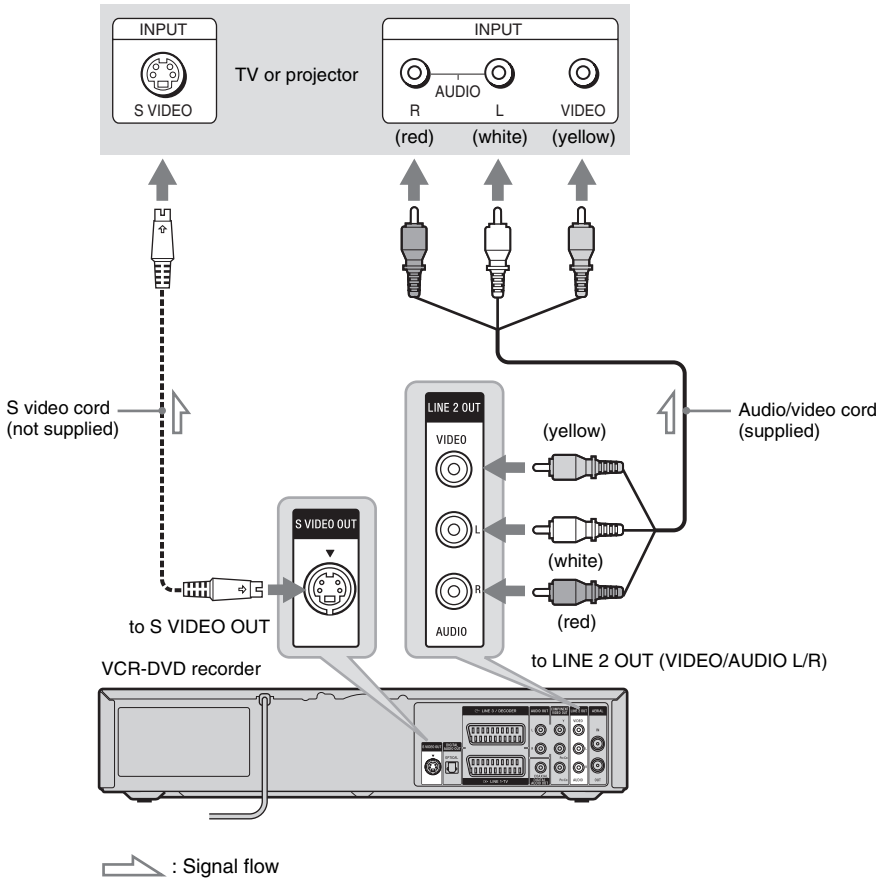

When playing "wide screen" images

Some recorded images may not fit your TV screen. To change the picture size, see page 101.

Notes

- During DVD recording, you cannot watch VHS pictures by pressing VIDEO, as the S VIDEO OUT jack will output DVD video signals only.
- Do not connect your TV's audio output jacks to the LINE 2 IN (AUDIO L/R) jacks at the same time. This will cause unwanted noise to come from your TV's speakers.

Connecting to the SCART jack

Connect to the LINE 1-TV jack using a SCART cord (not supplied). Be sure to make the connections firmly to avoid hum and noise.

See the operating instructions supplied with the TV to be connected.

When you use this connection, select “Video” or “RGB” for the Line 1 output setting in step 14 of Easy Setup (page 22).

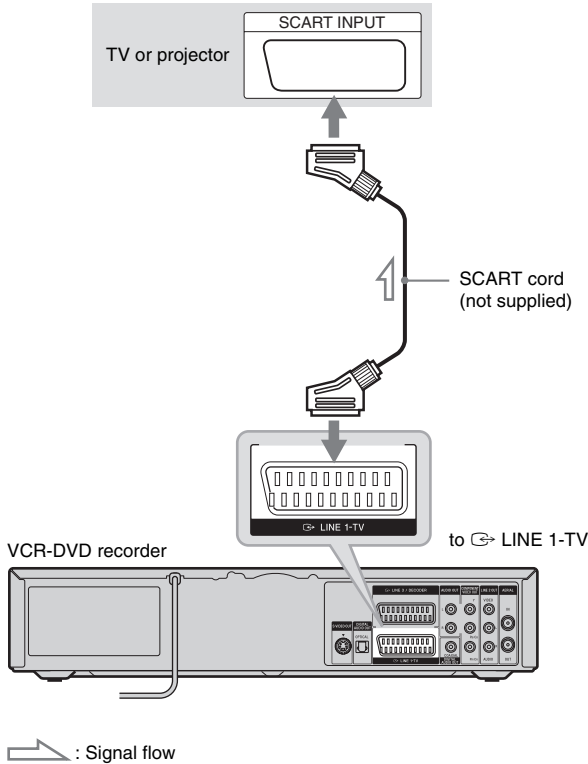

Note

When you connect the recorder to your TV via the SCART jacks, the TV's input source is set to the recorder automatically when you turn the recorder on. If necessary, press TV/VIDEO on the remote to return the input to the TV.

If your TV has component video input jacks

Connect to the COMPONENT VIDEO OUT jacks using a component video cord (not supplied) or three video cords (not supplied) of the same kind and length. You will enjoy accurate colour reproduction and high quality images.

When you use this connection, select “On” for the component out setting in step 10 of Easy Setup (page 22).

If your TV accepts progressive 525p/625p format signals, you must use this connection and then set “Progressive” to “On” in the “Video” setup (page 102). The PROGRESSIVE indicator lights up when the recorder outputs progressive signals.

When using this connection, be sure to connect the audio cord to the LINE 2 OUT (AUDIO L/R) jacks.

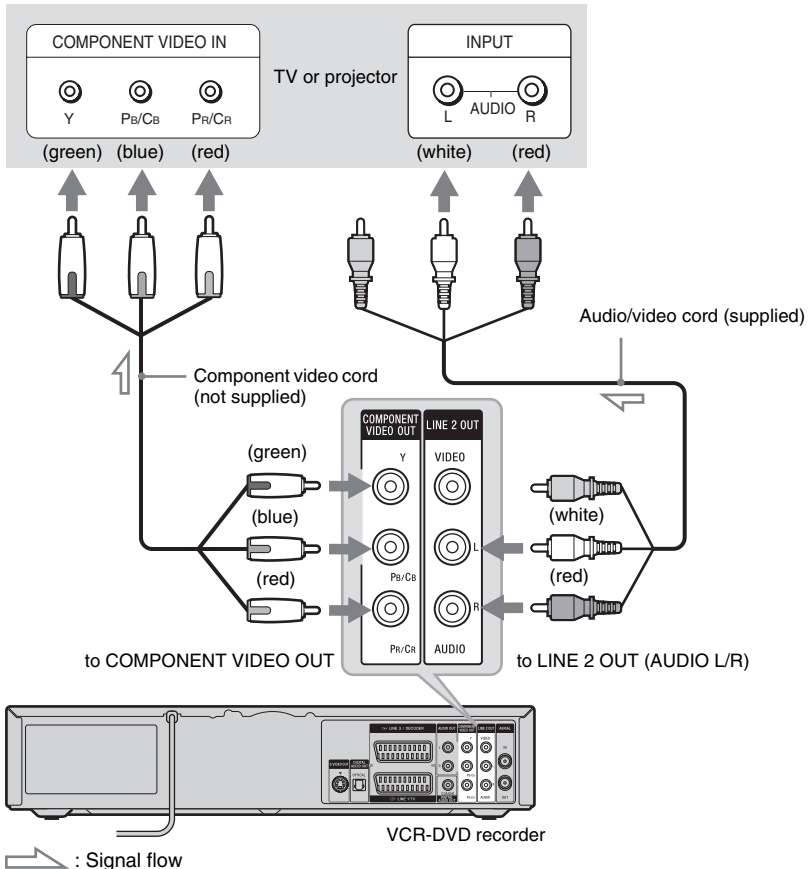

Hint

Video signal can also be output from the COMPONENT VIDEO OUT jack when playing a VHS tape.

Note

During DVD recording, you cannot watch VHS pictures by pressing VIDEO, as the COMPONENT VIDEO OUT jacks will output DVD video signals only.

Step 4: Connecting to Your AV Amplifier (Receiver)

Select one of the following patterns **A** or **B**, according to the input jack on your AV amplifier (receiver). This will enable you to listen to sound through your AV amplifier (receiver).

When you use this connection, select “Yes” for the component out setting in step 16 of Easy Setup (page 22).

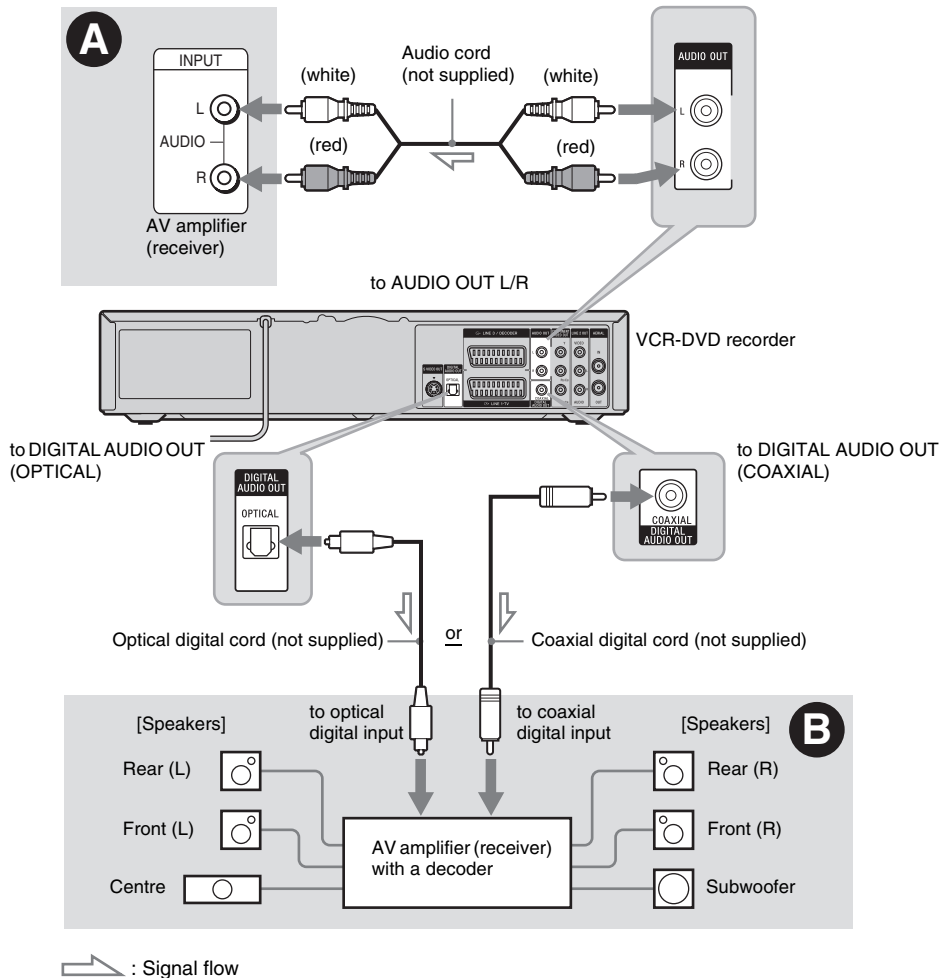

A Connecting to audio L/R jacks

This connection uses a stereo amplifier's (receiver's) two front speakers for sound. You can enjoy the surround function that creates virtual speakers from two stereo speakers. Select from "Surround1," "Surround2," or "Surround3" of the surround effects (page 35).
Surround 1

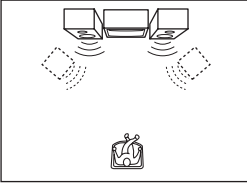

Surround 2

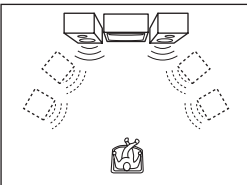

Surround 3

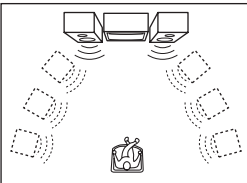

 Virtual speaker

B Connecting to a digital audio input jack

Use this connection if your AV amplifier (receiver) has a Dolby*¹ Digital, DTS*², or MPEG audio decoder and a digital input jack. You can enjoy the surround effect of Dolby Digital (5.1ch), DTS (5.1ch), or MPEG audio (5.1ch).

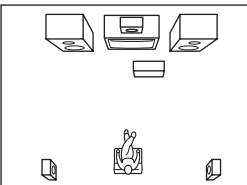

*¹ Manufactured under license from Dolby Laboratories. "Dolby" and the double-D symbol are trademarks of Dolby Laboratories.

*² "DTS" and "DTS Digital Out" are trademarks of Digital Theater Systems, Inc.

Hints

- For correct speaker location, see the operating instructions supplied with the connected components.
- Digital audio signal can also be output when playing a VHS tape.

Notes

- During DVD recording, you cannot hear VHS sound by pressing VIDEO, as the DIGITAL AUDIO OUT jacks will output DVD audio signals only.
- After you have completed the connection, make the appropriate settings in Easy Setup (page 22). If your AV amplifier (receiver) has an MPEG audio decoder function, set "Digital Out" – "MPEG" to "MPEG" in the "Audio" setup (page 103). Otherwise, no sound or a loud noise will come from your speakers.
- With a coaxial or optical digital connection, you cannot use the virtual surround effects of this recorder.
- This recorder does not support Linear PCM playback with 3 channels or more.
- When outputting from the DIGITAL AUDIO OUT jacks, you cannot switch the bilingual sounds on a DVD-RW (VR mode) by pressing  (audio).

Step 5: Connecting the Mains Lead

Plug the recorder and TV mains leads into the mains. After you connect the mains lead, **you must wait for a short while before operating the recorder**. You can operate the recorder only after the front panel display lights up and the recorder enters standby mode.

If you connect additional equipment to this recorder (page 26), be sure to connect the mains lead only after all connections are complete.

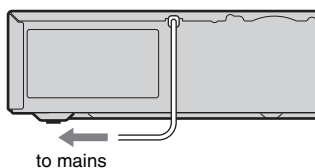

Step 6: Preparing the Remote

You can control the recorder using the supplied remote. Insert two R6 (size AA) batteries by matching the ⊕ and ⊖ ends on the batteries to the markings inside the battery compartment. When using the remote, point it at the remote sensor  on the recorder.

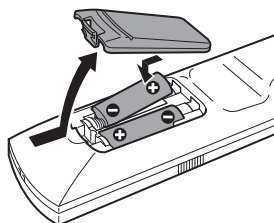

Notes

- If the supplied remote interferes your other Sony DVD recorder or player, change the command mode number for this recorder (page 25).
- Use the batteries correctly to avoid possible leakage and corrosion. Do not touch the liquid with bare hands should leakage occur. Observe the following:
 - Do not use a new battery with an old battery, or batteries of different manufacturers.
 - Do not attempt to recharge the batteries.
 - If you do not intend to use the remote for an extended period of time, remove the batteries.
 - If battery leakage occurs, wipe out any liquid inside the battery compartment, and insert new batteries.
- Do not expose the remote sensor (marked  on the front panel) to strong light, such as direct sunlight or lighting apparatus. The recorder may not respond to the remote.
- With normal use, the batteries should last about three to six months.
- Do not leave the remote in an extremely hot or humid place.
- Do not drop any foreign object into the remote casing, particularly when replacing the batteries.

Controlling TVs with the remote

You can adjust the remote control's signal to control your TV.

If you connected the recorder to an AV amplifier (receiver), you can also use the supplied remote to control the AV amplifier's (receiver's) volume.

Notes

- Depending on the connected unit, you may not be able to control your TV or AV amplifier (receiver) with some or all of the buttons below.
- If you enter a new code number, the code number previously entered will be erased.
- When you replace the batteries of the remote, the code number may be reset to the default setting. Set the appropriate code number again.

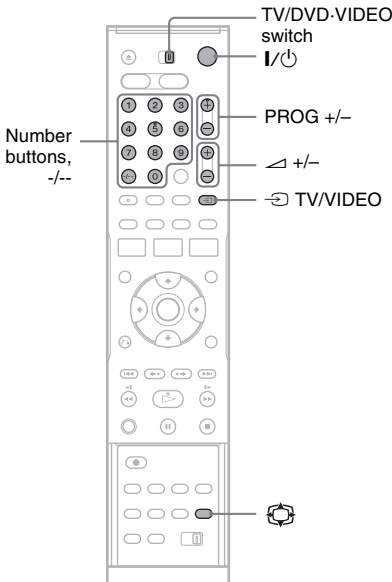

- 1 Slide the TV/DVD-VIDEO switch to TV.
- 2 Hold down I/⏻.
- 3 Enter your TV's manufacturer code (see below) using the number buttons.
- 4 Release I/⏻.

When the TV/DVD-VIDEO switch is set to TV, the remote performs the following:

Press	To
I/⏻	Turn your TV on or off

⏮ (volume) +/-	Adjust the volume of your TV
PROG +/-	Select the programme position on your TV
⏭ TV/VIDEO	Switch your TV's input source
Number buttons, -/--*	Select the programme position on a Sony TV
⏭ (wide mode)	Switch to or from the wide mode of a Sony wide-screen TV

* If you use the number buttons to select the TV's programme position, press -/-- followed by the number buttons for two-digit numbers.

To operate the ⏭ TV/VIDEO button (for SCART connections only)

The ⏭ TV/VIDEO button switches between the recorder and the last input source selected on the TV. Point your remote at the recorder when using this button. The button works even if the TV/DVD-VIDEO switch is set to DVD-VIDEO.

When you connect the recorder to your TV via the SCART jacks, the TV's input source is set to the recorder automatically when you turn the recorder on. To watch another source, press the ⏭ TV/VIDEO button to switch the TV's input source. "TV" appears in the front panel display.

Code numbers of controllable TVs

If more than one code number is listed, try entering them one at a time until you find the one that works with your TV.

Manufacturer	Code number
Sony	01 (default)
Aiwa	01 (default)
Grundig	11
Hitachi	23, 24, 72
Loewe	06, 45
Nokia	15, 16, 69, 73
Panasonic	17, 49
Philips	06, 07, 08, 23, 45, 72
Saba	12, 13, 36, 43, 74, 75
Samsung	06, 22, 23, 71, 72
Sanyo	25

Manufacturer	Code number
Sharp	29
Telefunken	12, 13, 36, 43, 74, 75
Thomson	12, 13, 43, 74, 75
Toshiba	38
LG	06
JVC	33

Controlling the volume of your AV amplifier (receiver) with the remote

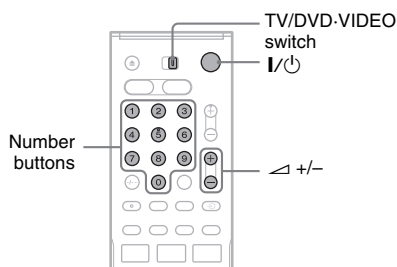

- 1** Slide the TV/DVD-VIDEO switch to DVD-VIDEO.
- 2** Hold down I/⏻, and enter the manufacturer code (see the table below) for your AV amplifier (receiver) using the number buttons.
- 3** Release I/⏻.

The \triangleleft +/- buttons control the AV amplifier's volume.

If you want to control the TV's volume, slide the TV/DVD-VIDEO switch to TV.

Hint

If you want to control the TV's volume even when the TV/DVD-VIDEO switch is set to DVD-VIDEO, repeat the steps above and enter the code number 90 (default).

Code numbers of controllable AV amplifiers (receivers)

If more than one code number is listed, try entering them one at a time until you find the one that works with your AV amplifier (receiver).

Manufacturer	Code number
Sony	78, 79, 80, 91
Denon	84, 85, 86
Kenwood	92, 93
Onkyo	81, 82, 83
Pioneer	99
Sansui	87
Technics	97, 98
Yamaha	94, 95, 96

Step 7: Easy Setup

Follow the steps below to make the minimum number of basic adjustments for using the recorder. If you do not complete Easy Setup, it will appear each time you turn on your recorder. Settings are made in the following order.

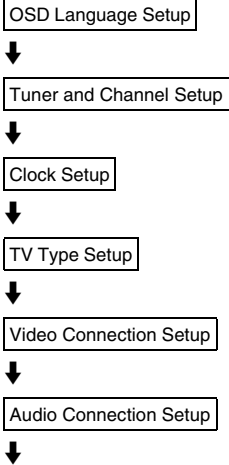

Finished!

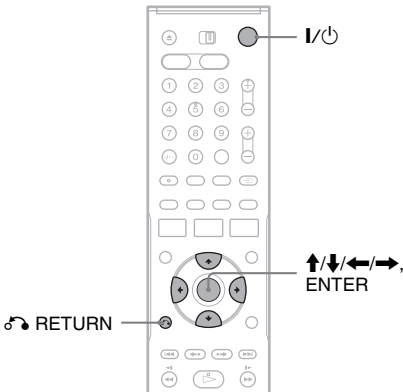

- 1 Turn on the TV.**
- 2 Press I/⏻.**
The recorder turns on.
- 3 Switch the input selector on your TV so that the signal from the recorder appears on your TV screen.**

“Initial setting necessary to operate the DVD recorder will be made. You can change them later using setup.” appears.

- If this message does not appear, select “Easy Setup” in the “Setup” display to run Easy Setup (page 108).

4 Press ENTER.

The setup display for selecting the language used in the on-screen display appears.

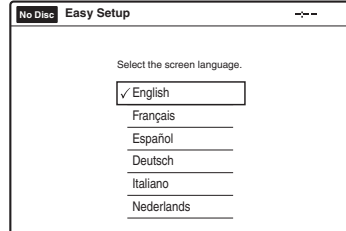

5 Select a language, and press ENTER.

The Tuner Preset function automatically starts.

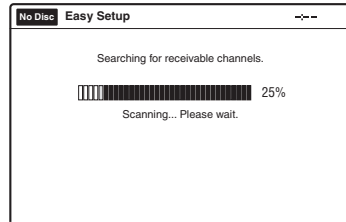

To set the channels manually, see page 98.

6 After the download or search is complete, the Clock function automatically starts.

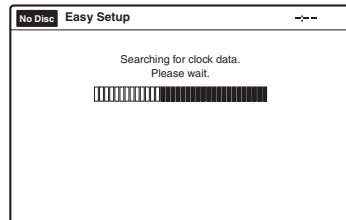

If the current date and time is not set, set the clock manually.

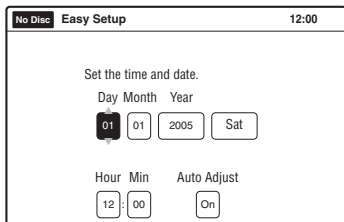

Press **↑/↓** to set the day and press **→**. Set the month, year, hour, minutes in the same way. Set “Auto Adjust” to “On” to activate the Auto Clock Set function. The recorder adjusts the clock automatically whenever the recorder is turned off.

7 Press ENTER.

The setup display for selecting the picture size of the connected TV appears.

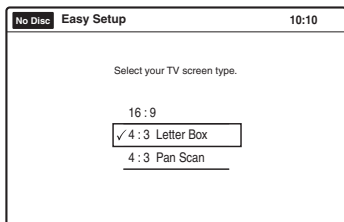

8 Select the setting that matches your TV type.

“4:3 Letter Box”: For standard TVs. Displays “wide screen” pictures with bands on the upper and lower sections of the screen.
 “4:3 Pan Scan”: For standard TVs. Automatically displays “wide screen” pictures on the entire screen and cuts off the sections that do not fit.
 “16:9”: For wide-screen TVs or standard TVs with a wide screen mode.
 For details, see “Video Settings (Video)” on page 101.

9 Press ENTER.

The setup display for the component out jacks appears.

10 Select whether or not to use the COMPONENT VIDEO OUT jacks.

Select “On” if you are using the COMPONENT VIDEO OUT jacks. Otherwise, select “Off.”

11 Press ENTER.

The setup display for the **↻ LINE 3/DECODER** jack appears.

12 Select whether or not to use the ↻ LINE 3/DECODER jack.

Select “Yes” if you will use the **↻ LINE 3/DECODER** jack. Otherwise, select “No.”

13 Press ENTER.

The setup display for selecting the type of video signal output from the **↻ LINE 1-TV** jack appears.

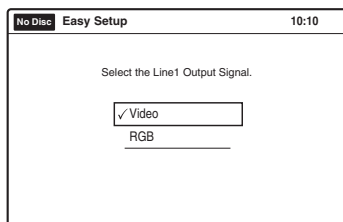

14 Select the type of signal you want to output from the ↻ LINE 1-TV jack.

“Video”: Outputs video signals.
 “RGB”: Outputs RGB signals.
 Note that if you select “On” in step 10, you cannot select “RGB.”

15 Press ENTER.

The setup display for selecting the type of jack used to connect to your amplifier (receiver) appears.

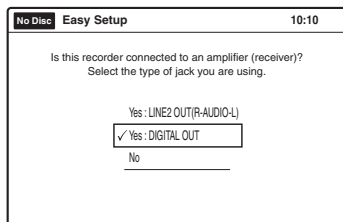

16 Select the type of jack (if any) you are using to connect to an amplifier (receiver).

If you did not connect an AV amplifier (receiver), select “No,” then go to step 21.
If you connected an AV amplifier (receiver) using an audio cord to the LINE 2 OUT (AUDIO L/R) or AUDIO OUT L/R jacks, select “Yes: LINE 2 OUT (R-AUDIO-L),” then go to step 21.
If you connected an AV amplifier (receiver) using either a digital optical or coaxial cord, select “Yes: DIGITAL OUT.”

17 Press ENTER.

The setup display for selecting the type of Dolby Digital signal appears.

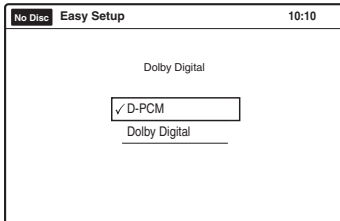

18 Select the type of Dolby Digital signal you want to send to your amplifier (receiver).

If your AV amplifier (receiver) has a Dolby Digital decoder, select “Dolby Digital.”
Otherwise, select “D-PCM.”

19 Press ENTER.

The setup display for the DTS signal appears.

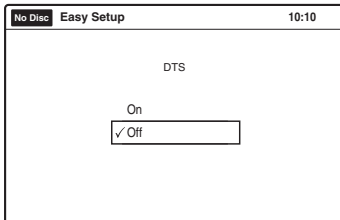

20 Select whether or not you want to send a DTS signal to your amplifier (receiver), and press ENTER.

If your AV amplifier (receiver) has a DTS decoder, select “On.” Otherwise, select “Off.”

21 Press ENTER when “Finish” appears.

Easy Setup is finished. All connections and setup operations are complete.

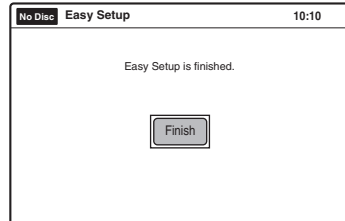

To return to the previous display

Press  RETURN.

Hints

- If your AV amplifier (receiver) has an MPEG audio decoder, set “Digital Out” – “MPEG” to “MPEG” in the “Audio” setup (page 103).
- If you want to run Easy Setup again, select “Easy Setup” in the “Setup” display (page 108).

Note

To record TV programmes using the timer, you must set the clock accurately.

If you have a Sony DVD player or more than one Sony DVD recorder

If the supplied remote interferes with your other Sony DVD recorder or player, set the command mode number for this recorder and the supplied remote to one that differs from the other Sony DVD recorder or player.

The default command mode setting for this recorder and the supplied remote is DVD 3.

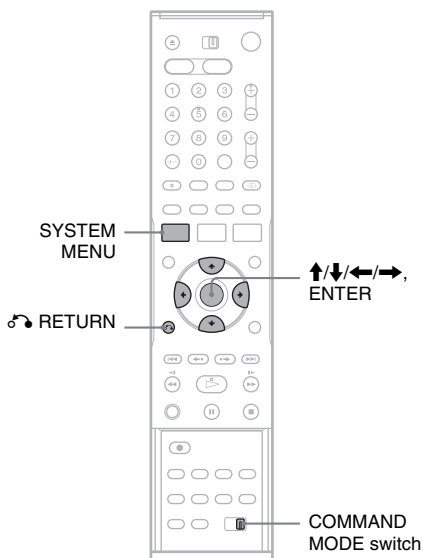

1 Press SYSTEM MENU.
The System Menu appears.

2 Select "Setup," and press ENTER.

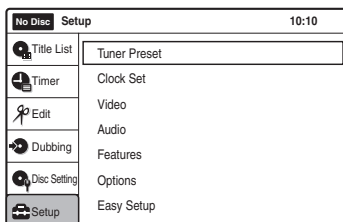

3 Select "Options," and press ENTER.

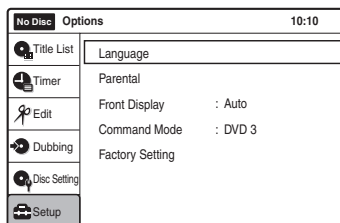

4 Select "Command Mode," and press ENTER.

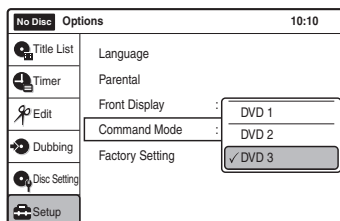

5 Select the command mode ("DVD 1," "DVD 2," or "DVD 3"), and press ENTER.

6 Slide the COMMAND MODE switch on the remote so it matches the mode you selected above.

To return to the previous display

Press RETURN.

Note

If the command mode does not match, the recorder's command mode appears on the front panel display when you operate the remote. Set the remote's command mode to one that matches the recorder's.

Connecting Another VCR or Similar Device

When you connect additional equipment to this recorder, be sure to connect the mains lead only after all connections are complete (page 19).

See also the instruction manual supplied with the connected equipment.

To record on this recorder, see “Recording From Connected Equipment Without a Timer” on pages 57 and 85.

Note that this recorder has a copy guard function. Pictures containing copy protection signals that prohibit any copying cannot be recorded. For details, see “Before Recording” on pages 47 and 76.

Connecting to the LINE 2 IN jacks on the front panel

Connect another VCR or similar recording device to the LINE 2 IN jacks of this recorder. If the equipment has an S video jack, you can use an S video cord (not supplied) instead of the yellow (video) plug of the audio/video cord. You can connect a second DVD player and record DVDs.

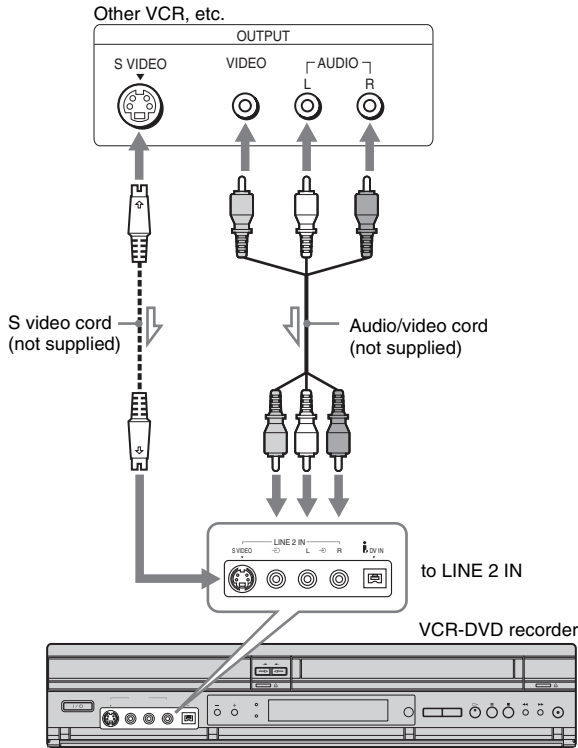

 : Signal flow

Hint

When the connected equipment outputs only monaural sound, connect an audio cord to the LINE 2 IN  (audio) L (MONO) jack.

Notes

- Do not connect the yellow LINE 2 IN  (video) jack when using an S video cord.
- Turn on the recorder to view pictures from the connected equipment.

Connecting to the LINE 3/DECODER jack

Connect another VCR or similar recording device to the LINE 3/DECODER jack using a SCART cord (not supplied).
 When you turn on the connected equipment, the recorder automatically sends the signal from the equipment to the TV without turning itself on.

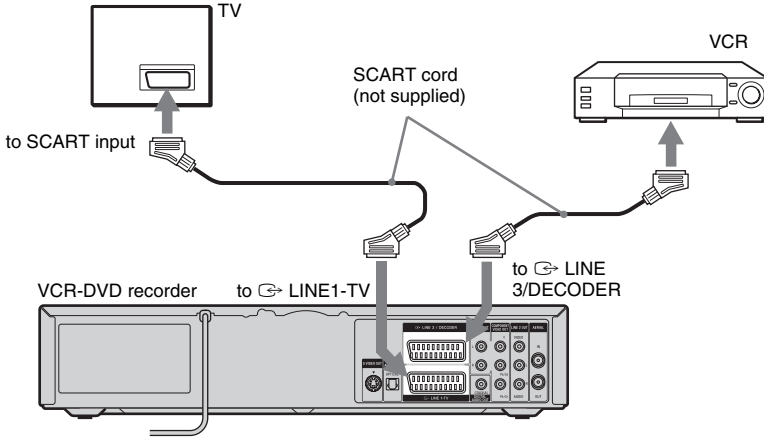

Notes

- Do not connect the output jack of this recorder to another equipment's input jack with the other equipment's output jack connected to the input jack of this recorder. Noise (feedback) may result.
- If you pass the recorder signals via a VCR, you may not receive a clear image on your TV screen.

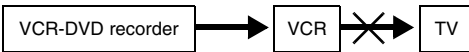

Be sure to connect your VCR to the VCR-DVD recorder and your TV in the order shown below. To watch video tapes, watch the tapes through a second line input on your TV.

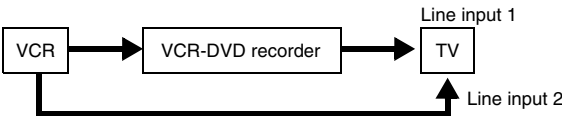

Connecting to a Satellite or Digital Tuner

Connect a satellite or digital tuner to this recorder using the LINE 3/DECODER jack. Disconnect the recorder's mains lead from the mains when connecting the tuner.

When you turn on the tuner, the recorder automatically sends the signal from the tuner to the TV without turning itself on.

To use the Synchro Rec function, see below.

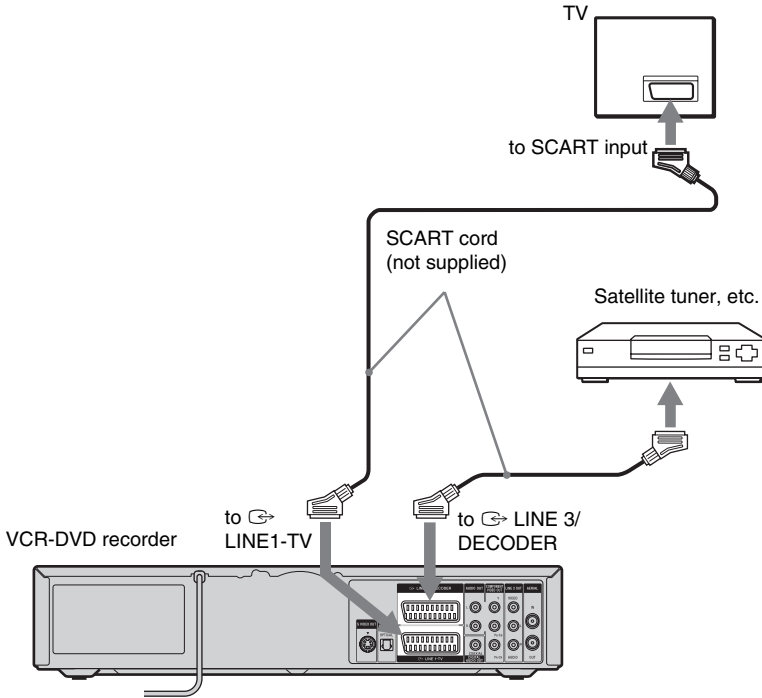

If the satellite tuner can output RGB signals

This recorder accepts RGB signals. If the satellite tuner can output RGB signals, connect the TV SCART connector on the satellite tuner to the LINE 3/DECODER jack.

When you want to use the Synchro Rec function











This connection is necessary to use the Synchronized Recording function. See "Recording From Connected Equipment With a Timer (Synchro Rec)" (pages 54 and 82).

If you are using a B Sky B tuner, be sure to connect the tuner's VCR SCART jack to the LINE 3/DECODER jack.

Notes

- Synchronized Recording does not work with some tuners. For details, see the tuner's operating instructions.
- The recorder cannot record original RGB signals from the tuner, but records them in the composite video format.
- When you connect the recorder to your TV via the SCART jacks, the TV's input source is set to the recorder automatically when you turn the recorder on.

Recordable and Playable Discs

Disc Type		Disc Logo	Icon used in this manual	Formatting (new discs)	Compatibility with other DVD players (finalizing)
DVD+RW		 DVD+ ReWritable		Automatically formatted	Playable on DVD+RW compatible players (automatically finalized)
DVD-RW	VR mode			Format in VR mode*2 (page 69)	Playable only on VR mode compatible players (finalization unnecessary) (page 91)
	Video mode			Format in Video mode*2 (page 69)	Playable on most DVD players (finalization necessary) (page 91)
DVD+R				Automatically formatted	Playable on DVD+R compatible players (finalization necessary) (page 91)
DVD+R DL					
DVD-R				Automatically formatted	Playable on most DVD players (finalization necessary) (page 91)

Usable disc versions (as of May 2005)

- 4x-speed or slower DVD+RWs
- 2x-speed or slower DVD-RWs (Ver.1.1, Ver.1.1 with CPRM*1)
- 4x-speed or slower DVD-RWs (Ver.1.2, Ver.1.2 with CPRM)
- 8x-speed or slower DVD+Rs
- 8x-speed or slower DVD-Rs (Ver.2.0)
- 2.4x-speed DVD+R DL (Double Layer) discs*5

“DVD+RW,” “DVD-RW,” “DVD+R,” “DVD+R DL,” and “DVD-R” logos are trademarks.

	Recording Features			Editing Features				
	Rewrite (page 69)	Auto Chapter (page 50)	Manual Chapter (page 62)	Change Title Name (page 63)	Erase Title/ Chapter (page 59)	A-B Erase (page 60)	Divide Title (page 61)	Playlist (page 64)
	Yes	Yes	Yes	Yes	Yes* ³ /No	No	Yes	No
	Yes	Yes	Yes	Yes	Yes/Yes	Yes	Yes	Yes
	Yes	Yes	No	Yes	Yes* ³ /No	No	No	No
	No	Yes	No	Yes	Yes* ⁴ /No	No	No	No
	No	Yes	No	Yes	Yes* ⁴ /No	No	No	No

Discs that cannot be recorded on

- DVD-RWs (Ver.1.0)
- DVD+RWs that are not 2.4×-speed compatible
- 8 cm discs
- DVD-R DL (Dual Layer) discs
- DVD-Rs recorded in VR mode (Video Recording format)
- DVD-Rs with CPRM*¹

*¹ CPRM (Content Protection for Recordable Media) is a coding technology that protects copyrights for images.

*² Unused DVD-RWs are automatically formatted according to the setting of "Format DVD" in "Features" setup (page 105).

*³ Erasing titles only frees up disc space if you erase the last title.









*⁴ Erasing titles does not free up disc space.

*⁵ When using DVD+R DL (Double Layer) discs, see the instructions supplied with the disc.

12 cm/8 cm discs

Operation	DVD+RW		DVD-RW				DVD+R		DVD-R	
			VR mode		Video mode					
	12 cm	8 cm	12 cm	8 cm	12 cm	8 cm	12 cm	8 cm	12 cm	8 cm
Playback	Yes	Yes	Yes	Yes	Yes	Yes	Yes	—	Yes	Yes
Recording	Yes	No	Yes	No	Yes	No	Yes	—	Yes	No

Playable Discs

Disc Type	Disc Logo	Icon Used In this Manual	Characteristics
DVD VIDEO			Discs such as movies that can be purchased or rented
VIDEO CD			VIDEO CDs or CD-Rs/CD-RWs in VIDEO CD/ Super VIDEO CD format (with PBC function)
CD			Music CDs or CD-Rs/CD-RWs in music CD format that can be purchased
DATA CD			CD-Rs/CD-RWs created on a PC or similar device in music format, or MP3 or JPEG format that conforms to ISO9660* Level 1/Level 2
DATA DVD	—		DVD+RWs/DVD-RWs/DVD+Rs/DVD-Rs in MP3 or JPEG format conforming to UDF.
8 cm DVD+RW/ DVD-RW/DVD-R	—	—	8 cm DVD+RWs, DVD-RWs, and DVD-Rs recorded with a DVD video camera (Still images recorded with a DVD video camera cannot be played.)

“DVD VIDEO” and “CD” logos are trademarks.

* A logical format of files and folders on DATA-CDs, defined by ISO (International Standard Organization).

Discs that cannot be played

- CD-Rs/CD-RWs, other than those recorded in music CD format, MP3 or JPEG format, or Video CD format
- Data part of CD-Extras
- CD-ROMs
- DVD-ROMs
- DVD Audio discs
- DVD-R DL (Dual Layer) discs
- DVD-Rs recorded in VR mode (Video Recording format)
- DVD-Rs with CPRM
- DVD-RAMs
- HD layer on Super Audio CDs
- DVD VIDEOS with a different region code (see page 33)

Note on playback operations of DVD VIDEOS/VIDEO CDs

Some playback operations of DVD VIDEOS/VIDEO CDs may be intentionally set by software producers. Since this recorder plays DVD VIDEOS/VIDEO CDs according to the disc contents the software producers designed, some playback features may not be available. Also, see the instructions supplied with the DVD VIDEOS/VIDEO CDs.

Note on DualDiscs

A DualDisc is a two sided disc product which mates DVD recorded material on one side with digital audio material on the other side. However, since the audio material side does not conform to the Compact Disc (CD) standard, playback on this product is not guaranteed.

Region code (DVD VIDEO only)

Your recorder has a region code printed on the rear of the unit and will only play DVD VIDEOS (playback only) labelled with identical region codes. This system is used to protect copyrights. DVD VIDEOS labeled  will also play on this recorder.

If you try to play any other DVD VIDEO, a message will appear on the TV screen to indicate that the disc is not playable. Depending on the DVD VIDEO, no region code indication may be labelled even though playing the DVD VIDEO is prohibited by area restrictions.

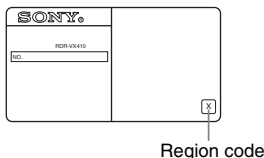

Music discs encoded with copyright protection technologies

This product is designed to playback discs that conform to the Compact Disc (CD) standard. Recently, various music discs encoded with copyright protection technologies are being marketed by some record companies. Please be aware that among those discs, there are some that do not conform to the CD standard and may not be playable by this product.

Notes

- Some DVD+RWs/DVD+Rs, DVD-RWs/DVD-Rs, or CD-RWs/CD-Rs cannot be played on this recorder due to the recording quality or physical condition of the disc, or the characteristics of the recording device and authoring software. The disc will not play if it has not been correctly finalized. For more information, see the operating instructions for the recording device.
- You cannot mix VR mode and Video mode on the same DVD-RW. To change the disc's format, reformat the disc (page 69). Note that the disc's contents will be erased after reformatting.
- You cannot shorten the time required for recording even with high-speed discs. Also, you cannot record on the disc if the disc is not 1x speed compatible.
- It is recommended that you use discs with "For Video" printed on their packaging.
- You cannot add new recordings to DVD-RWs (Video mode) or DVD-Rs that contain recordings made on other DVD equipment.
- You may not be able to further record on a DVD+RW recorded on other equipment. Note that recording on such discs may cause the recorder to rewrite the DVD menu.
- If the disc contains PC data unrecognizable by this recorder, the data may be erased.

DVD Playback

Playing

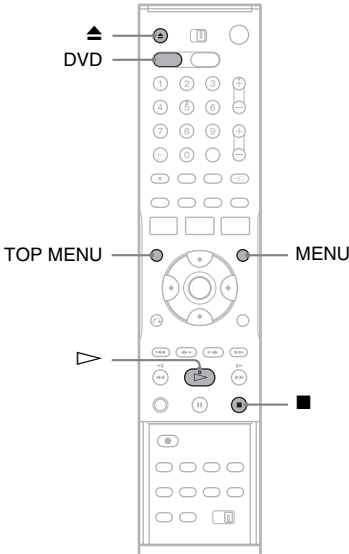

- 1 Press DVD to operate the DVD recorder.
- 2 Press ▲ (open/close), and place a disc on the disc tray.



- 3 Press ▲ to close the disc tray.
Wait until "LOAD" disappears from the front panel display.
- 4 Press ▷ (play).
Playback starts.

To stop playback

Press ■ (stop).

Hints

- When playing a DVD+RW, DVD-RW, DVD+R, and DVD-R, you can select the title from the Title List menu. See "Playing a Title From the Title List" (page 39).
- To play DATA CDs or DATA DVDs containing MP3 tracks or JPEG files, see pages 42 and 43.
- If you inserted a DVD VIDEO, VIDEO CD, or CD, playback starts automatically depending on the disc.

Notes

- To play a disc recorded with other equipment on this recorder, finalize the disc on the recording equipment first.
- For simultaneous VHS and DVD operation, see page 9.

Using the DVD's Menu





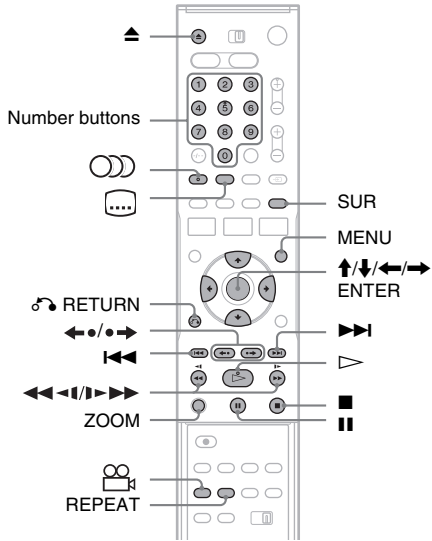

When you play a DVD VIDEO, or a finalized DVD+RW, DVD-RW (Video mode), DVD+R, or DVD-R, you can display the disc's menu by pressing TOP MENU or MENU.

Playback Options



Button	Operation	Disc
▲ (open/close)	Stops playing and opens the disc tray.	All discs
⦶ (audio)	Selects one of the audio tracks recorded on the disc when pressed repeatedly. DVD : Selects the audio source. VCD : Selects stereo or monaural audio tracks.	DVD VCD
⋮ (subtitle)	Selects a subtitle language when pressed repeatedly.	DVD
⦶ _k (angle)	Selects an angle when pressed repeatedly. If various angles (multi-angles) for a scene are recorded on the disc, “⦶ _k ” appears in the front panel display.	DVD
ZOOM	Zooms into a scene during playback or still mode when pressed repeatedly. Magnification changes as follows: normal → ×2 → ×4 → normal The zoom function may not work depending on the DVD. To zoom in a JPEG image, see page 44.	+RW -RWvR -RW_{video} +R -R DVD VCD

Button	Operation	Disc								
SUR (surround)	Surround lets you enjoy surround sound effects by using sound imaging to create virtual rear speakers from a stereo TV or two front speakers (page 18). Selects one of the effects when pressed repeatedly. “Off”: No surround effect “Surround1”: Creates one set of virtual surround speakers. “Surround2”: Creates two sets of virtual surround speakers. “Surround3”: Creates three sets of virtual surround speakers. This feature is effective when you use two separate front speakers.	All discs								
◀●/●▶ (replay/advance)	<ul style="list-style-type: none"> Replays or briefly fast forwards a scene when pressed during playback. Goes to the previous or next frame when pressed during pause mode. 									
⏮/⏭ (previous/next)	<ul style="list-style-type: none"> Goes to the beginning of the current or next title/chapter/scene/track and starts playback when pressed during playback. Goes to the beginning of the previous title/chapter/scene/track when ⏮ is pressed within three seconds after starting a title/chapter/scene/track. 	All discs								
◀◀◀/▶▶▶ (fast reverse/fast forward)	Fast reverses or fast forwards the disc when pressed during playback. Search speed changes with each press: <table style="margin-left: auto; margin-right: auto; border: none;"> <tr> <td style="padding: 0 10px;">fast reverse</td> <td style="padding: 0 10px;">fast forward</td> </tr> <tr> <td style="text-align: center;">FR1 ←</td> <td style="text-align: center;">→ FF1^{*1}</td> </tr> <tr> <td style="text-align: center;">FR2^{*2} ←←</td> <td style="text-align: center;">→→ FF2^{*2}</td> </tr> <tr> <td style="text-align: center;">FR3^{*3} ←←←</td> <td style="text-align: center;">→→→ FF3^{*3}</td> </tr> </table>	fast reverse	fast forward	FR1 ←	→ FF1 ^{*1}	FR2 ^{*2} ←←	→→ FF2 ^{*2}	FR3 ^{*3} ←←←	→→→ FF3 ^{*3}	All discs ^{*1} FF1 with sound (Scan Audio) is available for DVDs with Dolby Digital soundtracks. ^{*2} FR2 and FF2 are not available for MP3. ^{*3} FR3 and FF3 are only available for DVDs and VIDEO CDs.
fast reverse	fast forward									
FR1 ←	→ FF1 ^{*1}									
FR2 ^{*2} ←←	→→ FF2 ^{*2}									
FR3 ^{*3} ←←←	→→→ FF3 ^{*3}									
◀◀◀/▶▶▶ (slow)	Plays in slow motion when pressed in pause mode. Playback speed changes with each press: <table style="margin-left: auto; margin-right: auto; border: none;"> <tr> <td style="padding: 0 10px;">reverse slow motion</td> <td style="padding: 0 10px;">forward slow motion</td> </tr> <tr> <td style="text-align: center;">◀◀3 ←</td> <td style="text-align: center;">→ 3▶▶</td> </tr> <tr> <td style="text-align: center;">◀◀2 ←←</td> <td style="text-align: center;">→→ 2▶▶</td> </tr> <tr> <td style="text-align: center;">◀◀1 ←←←</td> <td style="text-align: center;">→→→ 1▶▶</td> </tr> </table>	reverse slow motion	forward slow motion	◀◀3 ←	→ 3▶▶	◀◀2 ←←	→→ 2▶▶	◀◀1 ←←←	→→→ 1▶▶	 [*] Playback direction only
reverse slow motion	forward slow motion									
◀◀3 ←	→ 3▶▶									
◀◀2 ←←	→→ 2▶▶									
◀◀1 ←←←	→→→ 1▶▶									
⏸ (pause)	Pauses playback. If you pause playback for more than five minutes, playback starts automatically.	All discs								

Button	Operation	Disc
REPEAT	<p>Displays the items to be repeated when pressed. Select an item using \uparrow/\downarrow, and press ENTER. To cancel Repeat Play, select “Off” and press ENTER. Press \rightarrow RETURN to turn off the display.</p> <p>When playing a DVD</p> <p>“Chapter”: Repeats the current chapter. “Title”: Repeats the current title on a disc. “A-B” (Repeat A-B Play): Repeats a specific portion (page 38).</p> <p>When playing a VIDEO CD (with PBC function off)</p> <p>“Track”: Repeats the current track. “Disc”: Repeats all of the tracks. “A-B (Repeat A-B Play)”: Repeats a specific portion (page 38).</p>	 <p>* With PBC function off</p>
	<p>Selects the item to be repeated when pressed repeatedly. To cancel Repeat Play, select “Off.”</p> <p>When playing a CD</p> <p>“Track”: Repeats the current track. “Disc”: Repeats all of the tracks.</p> <p>When playing a DATA CD/DATA DVD (MP3 audio)</p> <p>“File”: Repeats the current track. “Folder”: Repeats the current album.</p>	

To resume normal playback, press \triangleright .

Hints

- You can change playback options, such as subtitle, audio track, angle, etc., using the TOOLS menu (page 11).
- During playback or pause mode, the recorder’s \lll/\ggg buttons and the remote’s \lll/\ggg buttons work the same way (page 36). Hold the buttons down during playback to fast reverse or fast forward. In pause mode, you can play in slow motion. Three speeds are available, depending on the duration of the press.
- See “DVD Audio/Subtitle Language” on page 124 for the meaning of the language abbreviation.

Notes

- You cannot use the repeat play function with VIDEO CDs while the PBC function is on (page 38).
- When the playback signal does not contain a signal for the surround speakers, the surround effects will be difficult to hear.
- When you select one of the surround modes, turn off the surround settings of the connected TV or amplifier (receiver).
- If you pause playback of a CD, or DATA CD/DATA DVD containing MP3 audio tracks, playback will not start until you press \triangleright or \blacksquare .
- Make sure that your listening position is between and at an equal distance from your speakers, and that the speakers are located in similar surroundings.

- Sound will be interrupted during Scan Audio (page 38).

Notes on playing DTS soundtracks on a CD

When playing DTS-encoded CDs, excessive noise will be heard from the analog stereo jacks. To avoid possible damage to the audio system, the consumer should take proper precautions when the analog stereo jacks of the recorder are connected to an amplification system. To enjoy DTS Digital Surround™ playback, an external 5.1-channel decoder system must be connected to the digital jack of the recorder.

Notes on playing DVDs with a DTS soundtrack

DTS audio signals are output only through the DIGITAL AUDIO OUT (COAXIAL or OPTICAL) jack. When you play a DVD with DTS soundtracks, set “Digital Out” – “DTS” to “On” in the “Audio” setup (page 103).

Playing quickly with sound (Scan Audio) (DVDs with Dolby Digital soundtracks only)

You can play quickly with dialogue or sound during FF1 fast-forward of a DVD with Dolby Digital soundtracks. Simply press ►► during playback.

Hint

To turn off the Scan Audio function, set “Scan Audio” to “Off” in the “Audio” setup (page 104).

Note

Sound will be interrupted during Scan Audio.

Playing VIDEO CDs with PBC functions

VCD

PBC (Playback Control) allows you to play VIDEO CDs interactively using a menu on your TV screen.

When you start playing a VIDEO CD with PBC functions, a menu appears.

Select an item using the number buttons and press ENTER. Then follow the instructions in the menu (press ► when “Press SELECT” appears).

Operations differ depending on the disc. See the instructions supplied with the disc.

To cancel PBC Playback

Press MENU to display “Menu: Off.” To use the PBC functions, press MENU again to display “Menu:On.”

Resuming playback from the point where you stopped the disc (Resume Play)

Press ► again after stopping a disc to resume playback from the same point.

To start from the beginning, press ■ twice, and press ►.



The point where you stopped playing is cleared when:

- you open the disc tray.
- you play another title.
- you switch the Title List menu to original or Playlist (DVD-RW (VR mode) only).

- you edit the title after stopping playback.
- you make a recording.

Repeating a specific portion (Repeat A-B Play)

+RW **-RW/VR** **-RW_{Video}** **+R** **-R** **DVD**
VCD*

- 1 During playback, press REPEAT.
- 2 Select “A” using .
- 3 Press ENTER at the starting point (point A) of the portion to be played repeatedly. “A-” appears.
- 4 Continue playing or press  to locate the ending point (point B), and press ENTER. Repeat A-B Play starts.

To return to normal playback, press REPEAT to select “Off” and press ENTER. Press  RETURN to turn off the display.

* Only with PBC function off

Playing restricted DVDs (Parental Control)

DVD

If you play a restricted DVD, a message appears asking whether you want to override the restriction.

- 1 Select “OK” and press ENTER.
The display for entering your password appears.
- 2 Enter your four digit password using the number buttons.
The recorder starts playback.

To register or change the password, see “Parental (DVD VIDEOS only)” on page 107.

Locking the recorder (Child Lock)

You can lock all of the buttons on the recorder so that the settings are not cancelled by mistake.

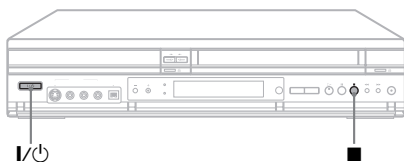

With the recorder turned on, hold down **I/Power** on the recorder. The recorder turns off and “CHILD LOCK” appears in the front panel display. The **I/Power** indicator remains lit if there is a timer setting. The recorder will not work except for timer recordings.

To unlock the recorder, hold down **I/Power** on the recorder until “CHILD LOCK” disappears from the front panel display. The recorder is unlocked and turns on.

To stop timer recording while the recorder is locked, press **■** twice. The recording stops and the recorder is unlocked.

Note

The recorder will be unlocked when:

- you stop timer recording by pressing **■**.
- you insert a tape.

Playing a Title From the Title List

+RW **-RWVR** **-RWVideo** **+R** **-R**

The Title List menu displays the program titles on the disc.

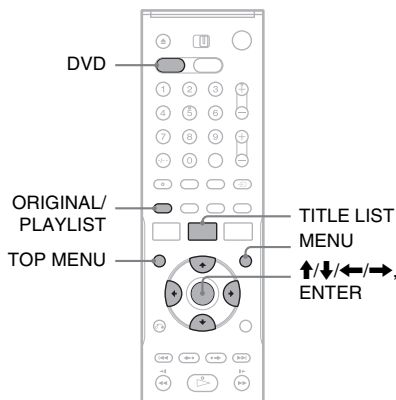



DVD Playback

- 1 Press **DVD** to operate the DVD recorder.
- 2 Place a disc on the disc tray.
- 3 Press **TITLE LIST**.

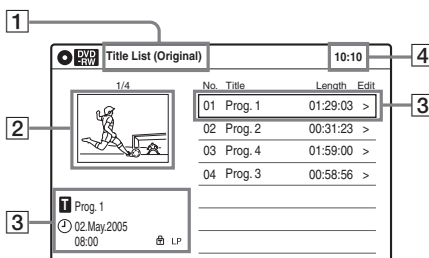
Example: DVD-RW (VR mode)



- 1 Title type (DVD-RWs (VR mode) only):
Displays the title type, “Title List (Original)” or “Playlist.”
- 2 Movie thumbnail image
- 3 Title information:
Displays the title number, title name, recording date, and recording mode.
“” indicates a protected title, while “” indicates unprotected.

4 Clock

4 Select the title, and press ENTER.

The sub-menu appears.

5 Select “Play,” and press ENTER.

Playback starts from the selected title on the disc.

About the Title List for DVD-RWs (VR mode)

You can switch the Title List to show original or Playlist.

While the Title List menu is turned on, press ORIGINAL/PLAYLIST repeatedly to select either “Title List (Original)” or “Playlist.”

For details, see “Edit options for DVD-RWs (VR mode)” on page 58.

To turn off the Title List

Press TITLE LIST.

Notes

- The Title List does not appear for DVD-RWs (Video mode), DVD+Rs, or DVD-Rs that have been finalized. To view a title, press TOP MENU or MENU (page 34).
- The Title List may not appear for discs created on other DVD recorders.
- Letters that cannot be displayed are replaced with “*.”

Searching for a Title/Chapter/Track, etc.

+RW -RWVR -RWvideo +R -R DVD
VCD

You can search a DVD by title or chapter, and VIDEO CD by track or scene. As titles and tracks are assigned individual numbers on the disc, select the title or track by entering its number. You can also search for a scene using the time code.

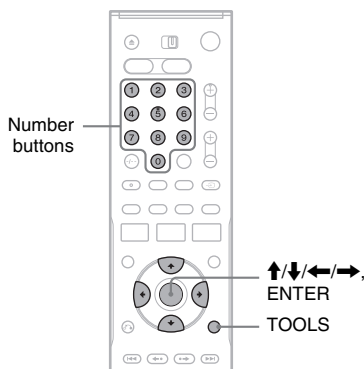

1 Press TOOLS during playback.

The TOOLS menu appears.

2 Select a search method.

“Title” (for DVDs)

“Chapter” (for DVDs)

“Track” (for VIDEO CDs with PBC function off)

“Time” (for DVDs/VIDEO CDs): Searches for a starting point by entering the time code.

3 Press $\uparrow/\downarrow/\leftarrow/\rightarrow$ to select the number of the title, chapter, track, etc., you want, or press the number buttons to enter the time code.

For example: “Time”

To find a scene at 2 hours, 10 minutes, and 20 seconds, enter “21020.”

If you make a mistake, wait a moment until the display returns to the elapsed playing time display, then select another number.

4 Press ENTER.

The recorder starts playback from the selected point.

To turn off the display, press TOOLS.

Note

Depending on the disc, you may not be able to use the TOOLS menu to search for a title/chapter/track, or enter the time code for a playback point.

Bookmarking a favourite scene (Bookmark)

+RW **-RWVr** **-RWVideo** **+R** **-R** **DVD**

You can have the recorder store specific portions of a disc in memory and play them immediately whenever you want (Bookmark). Up to ten bookmarks per disc can be set.

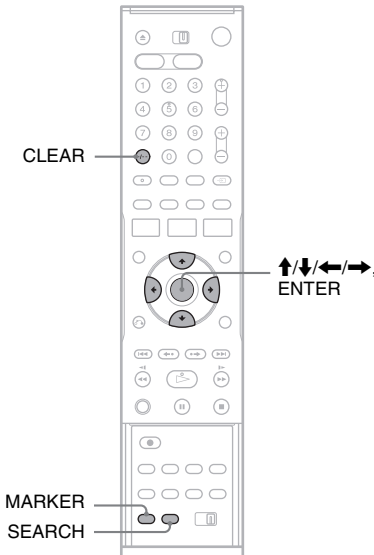

During playback, press MARKER at a favourite scene.

The bookmark is set.

To play from bookmarks

1 During playback, press SEARCH.

⊞ Search 01 02 03 04 05 - - - - - N:5

2 Press \leftarrow/\rightarrow to select a bookmark, and press ENTER.

Playback starts from the selected bookmark.

To erase bookmarks

1 During playback, press SEARCH.

2 Press \leftarrow/\rightarrow to select the bookmark to be erased.

3 Press CLEAR.

Note

When you eject the disc, the bookmark information is cleared.

Playing MP3 Audio Tracks

DATA CD DATA DVD

You can play MP3 audio tracks on DATA CDs (CD-Rs/CD-RWs) or DATA DVDs (DVD+RWs/DVD-RWs/DVD+Rs/DVD-Rs).

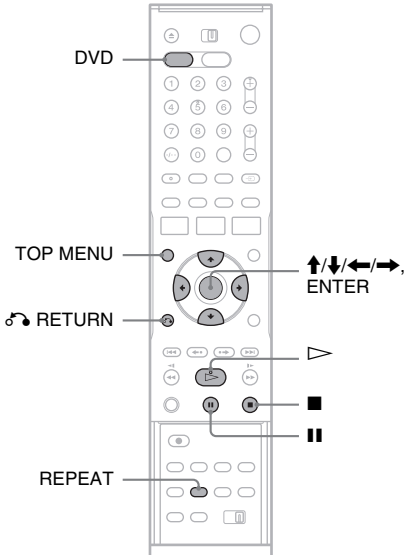

- 1 Press DVD to operate the DVD recorder.
- 2 Place a DATA CD/DATA DVD on the disc tray.

When you inserted a DATA CD/DATA DVD containing MP3 audio tracks and JPEG image files, the display for selecting a media type appears.

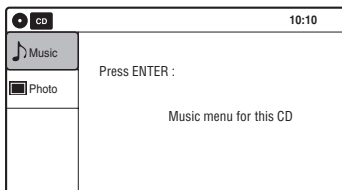

If you insert a DATA CD/DATA DVD containing only MP3 audio files, the “Music” display appears. Go to step 4.

- 3 Select “Music,” and press ENTER. The “Music” display appears.

- 4 Select an album, and press ENTER.

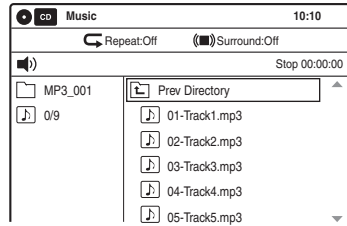

- 5 Select a track, and press ENTER.

Playback starts from the selected track.

When a track or album is being played, the title is shown in a box.

To stop playback

Press ■.

To pause playback

Press ■■.

To restart playback, press ▷ or ■■.

To play repeatedly

Press REPEAT repeatedly during playback.

“Off”: Does not play repeatedly.

“File”: Repeats the current track.

“Folder”: Repeats the current album.

To return to the previous display

Press ↶ RETURN.

To switch between MP3 audio tracks and JPEG image files

Press ■, and press TOP MENU.

About MP3 audio tracks

You can play back DATA CDs (CD-Rs/CD-RWs) or DATA DVDs (DVD+RWs/DVD-RWs/DVD+Rs/DVD-Rs) recorded in MP3 (MPEG-1 Audio Layer III) format. However, the discs must be recorded according to ISO9660 Level 1/Level 2 or Joliet format and DATA DVDs of Universal Disk Format (UDF) for the recorder to recognize the tracks (or files).

See the instructions supplied with the CD-R/CD-RW/DVD-R/DVD-RW drives and the recording software (not supplied) for details on the recording format.

Hints

- Since a disc with many trees takes longer to start playback, it is recommended that you create albums with no more than two trees.
- When playback of all the MP3 audio tracks within the album finishes, the recorder stops.

Notes

- The recorder may not be able to play some DATA CDs or DATA DVDs created in the Packet Write format.
- The recorder will play any data with the extension “.MP3,” even if they are not in MP3 format. Playing such data may generate a loud noise which could damage your speaker system.
- Only one session of a multi-session DATA-DVD can be played back.
- The recorder does not conform to audio tracks in MP3PRO format.
- The recorder can recognize up to 499 MP3 audio tracks within a single album. The recorder may not recognize some discs depending on the recording device used for recording or the disc condition.
- The recorder can play MP3 audio tracks recorded in the following sampling frequencies: 32 kHz, 44.1 kHz, 48 kHz.
- ID3 tags cannot be displayed.
- Only alphabet and numbers can be used for album or track names. Anything else is displayed as an asterisk.

Playing JPEG Image Files

DATA CD DATA DVD

You can play JPEG image files on DATA CDs (CD-Rs/CD-RWs) or DATA DVDs (DVD+RWs/DVD-RWs/DVD+Rs/DVD-Rs).

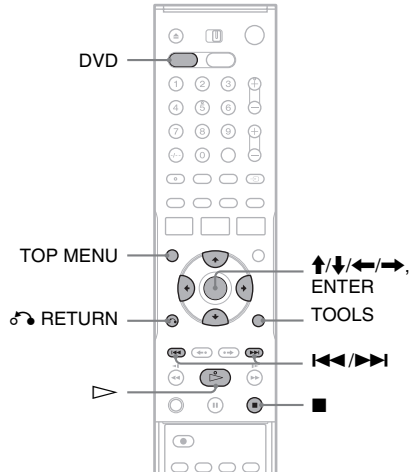

- 1 Press DVD to operate the DVD recorder.**
- 2 Place a DATA CD/DATA DVD on the disc tray.**

When you insert a DATA CD/DATA DVD containing MP3 audio tracks and JPEG image files, the display for selecting a media type appears.

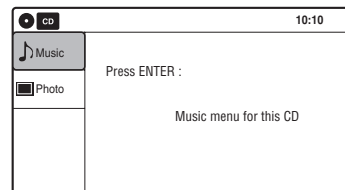

If you insert a DATA CD/DATA DVD containing only JPEG files, the “Photo” display appears. Go to step 4.

- 3 Select “Photo,” and press ENTER.**
The “Photo” display appears.

4 Select a folder, and press ENTER.

Directory information

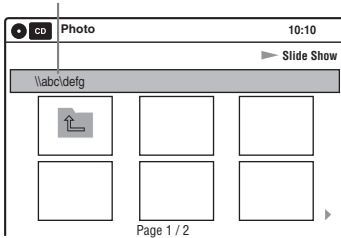

To display the previous/next page, press **◀/▶**.

5 Select an image file, and press ENTER.

The selected image is displayed over the entire screen.

To display the previous/next image, press **◀/▶**.

The following menu icons appear in the upper part of the screen.

: Returns to the “Photo” display.

: Starts the slide show (page 44).

: Rotates the image (page 44).

: Zooms the image (page 44).

Press **TOOLS** to turn on/off the menu icons.

To play the slide show

1 Press **◀/▶** to select “,” and press **ENTER**.

The “Slide Show Speed” menu appears.

“”: Slow

“”: Normal

“”: Fast

2 Press **◀/▶** to select the desired play speed, and press **ENTER**.

Slide show starts from the selected image. To stop playing, press **■**.

To rotate the selected image

Press **◀/▶** to select “,” and press **ENTER**. Each time you press **ENTER**, the image turns clockwise by 90°.

To zoom in an image

Press **◀/▶** to select “,” and press **ENTER**. Each time you press **ENTER**, the magnification changes as follows:

2× → 4× → 2× → normal

To return to the previous display

Press **↶** RETURN.

To switch between MP3 audio tracks and JPEG image files

Press **■**, and press **TOP MENU**.

Hint

You can also start the slide show by pressing **▷** in step 5 above.

Notes

- You cannot use **↑/↓/←/→** to move the image within the screen while zooming.
- Slide show can play in only one direction.
- You cannot rotate or zoom during slide show.
- If you select “” in the rotated image display, the images in the “Photo” display will not be rotated.

About JPEG image files

You can play back DATA CDs (CD-Rs/CD-RWs) or DATA DVDs (DVD+Rws/DVD-RWs/DVD+Rs/DVD-Rs) recorded in JPEG format.

However, the discs must be recorded according to ISO9660 Level 1/Level 2 or Joliet format and DATA DVDs of Universal Disk Format (UDF) for the recorder to recognize the tracks (or files). See the instructions supplied with the CD-R/CD-RW/DVD-R/DVD-RW drives and the recording software (not supplied) for details on the recording format.

Hint

If you add numbers (01, 02, 03, etc.) to the front of the file names, the files will be played in that order.

Notes

- The recorder can only play the files with the extension “JPG” or “JPEG.”
- Some DATA CDs or DATA DVDs cannot be played on this recorder depending on file format.
- If you add the extension “JPG” or “JPEG” to data not in JPEG format, a message appears indicating that the format is not supported.
- Only one session of a multi-session DATA-DVD can be played back.
- Depending on the disc or the size of image files, playback may take some time to start.
- The recorder can recognize up to 999 JPEG image files within a single folder. The recorder may not recognize some discs depending on the recording device used for recording or the disc condition.
- Progressive and lossless compression JPEG image files are not supported.

- The image size that the recorder can display is limited to width 32 - 7680 pixels by height 32 - 8192 pixels.

Displaying the Playing Time and Play Information



You can check disc information, such as playing time, recording mode, and remaining disc space.

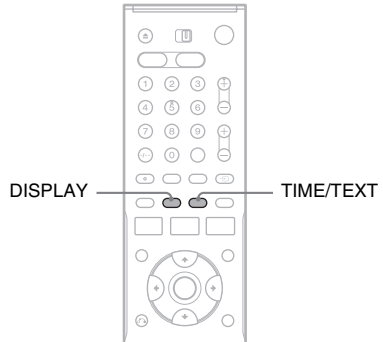

DVD Playback

Press DISPLAY.

The information display appears.

Each time you press the button, the display changes as follows:

Disc and tape information/date and time



Disc information only



No display

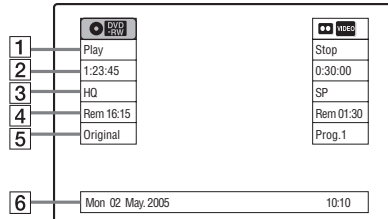

◆ DVD

- 1 Playing status
- 2 Playing time
- 3 Recording mode
- 4 Remaining disc space (in stop mode)
Remaining time of the current title (during playback)

5 Programme position or input source*

6 Date and time

* Title type (original or Playlist) for DVD-RWs (VR mode).

Viewing information on the front panel display

You can view the information on the front panel display.

Press TIME/TEXT repeatedly.

The displays differ depending on the disc type or playing status.

Example: When playing a DVD

Playing time of the current title

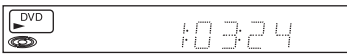

Current title number and current chapter number

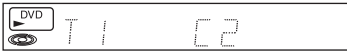

Clock



Example: When a DVD is stopped

Clock



Current title and chapter number



Remaining disc space



Programme position or input source

Example: When playing a CD

Playing time of the current track



Current track number



Clock

Before Recording

Before you start recording...

- This recorder can record on various discs types. Select the disc type according to your needs (page 30).
- Check that the disc has enough available space for the recording (page 45). For DVD+RWs or DVD-RWs, you can free up disc space by erasing titles (page 59).

Hint

To play a disc recorded with this recorder on other equipment, finalize the disc (page 91).

Notes

- Timer recordings cannot be made if the recorder is turned on (page 50). The recorder automatically turns off after a recording has finished.
- This recorder records at $\times 1$ speed.
- This recorder shares a single tuner for both the DVD recorder and the VCR. You cannot record different programmes to a DVD and a VHS tape at the same time.

Recording mode

Like the SP or LP recording mode of VCRs, this recorder has eight different recording modes. Select a recording mode according to the time and picture quality you need. For example, if picture quality is your top priority, select the High Quality mode (HQ). If recording time is your priority, Super Extended Play mode (SEP) can be a possible choice. Note that the recording time in the following table is an approximate guide.

Press REC MODE repeatedly to switch the recording modes.

I want to record with the best possible picture quality, so I'll select HQ.



Recording mode	Recording time (minute)
HQ (High quality)	60
HSP \uparrow	90
SP (Standard mode)	120
LSP \downarrow	150
LP \downarrow	180
EP \downarrow	240
SLP \downarrow	360
SEP (Long duration)	480

Note

Situations below may cause slight inaccuracies with the recording time.

- Recording a programme with poor reception, or a programme or video source of low picture quality
- Recording on a disc that has already been edited
- Recording only a still picture or just sound

Recording stereo and bilingual programmes

The recorder automatically receives and records stereo and bilingual programmes based on the NICAM system.

A DVD-RW (VR mode) can record both main and sub sounds. Press the  (audio) button to switch between main and sub when playing the disc.

A DVD+RW, DVD-RW (Video mode), DVD+R, or DVD-R can record only one sound track (main or sub) at a time. Select the sound track using the "Setup" display before recording starts. Set "DVD Bilingual Rec." to "Main" (default) or "Sub" in the "Features" setup (page 106).

NICAM system

When a stereo or bilingual NICAM based programme is received, "STEREO" and "NICAM" appear in the front panel display.







To record a NICAM programme, be sure to set "Manual Set" – "Tuner Audio" to "NICAM" (default) in the "Tuner Preset" setup (page 98). If the sound is not clear when listening to NICAM broadcasts, select "Standard."

Hint

You can select the audio (main or sub) while recording bilingual programmes using the  (audio) button. This does not affect the recorded sound.

Unrecordable pictures

Pictures with copy protection cannot be recorded on this recorder. Recording stops when a copy guard signal is detected.

Copy control signals	Recordable discs
Copy-Free	    
Copy-Once	 Ver.1.1 with CPRM* Ver.1.2 with CPRM*
Copy-Never	None

* The recorded disc can be played only on CPRM compatible equipment (page 31).

DVD Recording Without the Timer

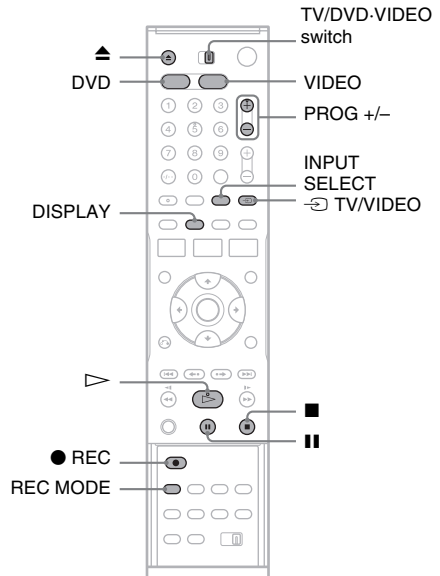

- 1 Press **DVD** to operate the DVD recorder.
- 2 Press **▲** (open/close), and place a recordable disc on the disc tray.

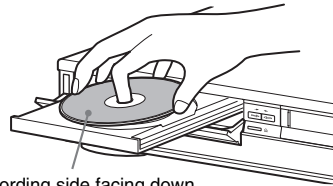

Recording side facing down

- 3 Press **▲** to close the disc tray.
Wait until "LOAD" disappears from the front panel display.
Unused DVD-RWs are formatted in VR mode automatically. To format in Video mode, see page 105.
- 4 Press **PROG +/-** or **INPUT SELECT** repeatedly to select the programme position or input source you want to record.

5 Press REC MODE repeatedly to select the recording mode.

The display changes on the TV screen as follows:

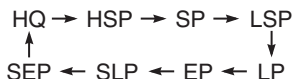

For details about the recording mode, see page 47.

6 Press ● REC.

Recording starts.

Recording continues until you stop the recording or the disc is full.

To stop recording

Press ■.

Note that it may take a few seconds for the recorder to stop recording.

To pause recording

Press ■■.

To restart recording, press ■■ again.

To watch another TV programme while recording

- 1 Slide the TV/DVD-VIDEO switch to TV.
- 2 Press ⊖ TV/VIDEO to set the TV to the TV input.
- 3 Select another programme position on the TV.

To watch a VHS tape while recording

Press VIDEO to operate the VCR, insert a tape, then press ▷.

🔧 Hints

- To play a disc recorded with this recorder on other equipment, finalize the disc (page 91).
- To select a programme position, you can use the number buttons. Enter the programme position number, and press ENTER.
- You can select a video source from the LINE jacks using the INPUT SELECT button.
- You can turn off the TV during recording. If you are using a satellite or digital tuner, make sure to leave it on.

Notes

- Recording may not start immediately after ● REC is pressed.
- You cannot change the recording mode during recording or recording pause.

- If there is a power failure, the programme you are recording may be erased.
- You cannot change the programme position or input source during recording.

Recording using the Quick Timer (One-touch Timer Recording)

You can set the recorder to record in 30-minute increments.

- 1 Press DVD to operate the DVD recorder.
- 2 Press ● REC repeatedly to set the duration.

Each press increases the time by 30 minutes, up to eight hours (12 hours for DVD+R DL (Double Layer) discs).

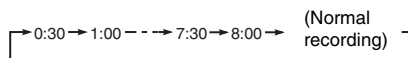

“⊙” and “OTR” light up, and the remaining recording time appears in the front panel display.

When the counter reaches “0:00,” the recorder stops recording and turns off.

To cancel the Quick Timer

Press ● REC repeatedly until the counter appears in the front panel display. The recorder returns to normal recording mode.

To stop recording.

Press ■ twice.

Note that it may take a few seconds for the recorder to stop recording.

Checking the disc status while recording

You can check the recording information such as recording time or disc type.

Press DISPLAY during recording.

The information display appears.

Press the button repeatedly to change the display (page 45).

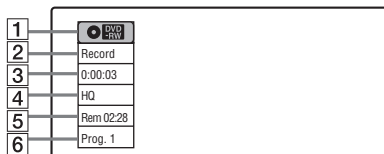

- 1 Disc type
- 2 Recording status
- 3 Recording time
- 4 Recording mode
- 5 Remaining disc space
- 6 Programme position or input source

Hint

You can view the information also in the front panel display. Press TIME/TEXT repeatedly to change the display. Note that TIME/TEXT does not work during One-touch Timer Recording.

Creating chapters in a title

The recorder will automatically divide a recording (a title) into chapters by inserting chapter marks at 5 or 15-minute intervals during recording. Select the interval, “5 min” (default) or “15 min” in “DVD Auto Chapter” of “Features” setup (page 105).

If you do not want to divide titles, select “Off.”

Hint

You can create chapters manually when playing DVD+RWs or DVD-RWs (VR mode) (page 62).

DVD Timer Recording (Standard/VIDEO Plus+)

+RW -RW/VR -RW_{Video} +R -R

You can set the timer for a total of 12 programmes together with DVD and VCR timer recording, up to one month in advance.

Note that the maximum continuous recording time for a single title is 12 hours. Contents beyond this time will not be recorded.

There are two methods to set the timer: the standard method and VIDEO Plus+ method.

- Standard: Set the date, time, and programme position of the programme manually.
- VIDEO Plus+: Enter the PlusCode number designated for each TV programme (page 52).

Note

The recorder must be in standby mode for the timer recording to be made.

Setting the timer manually (Standard)

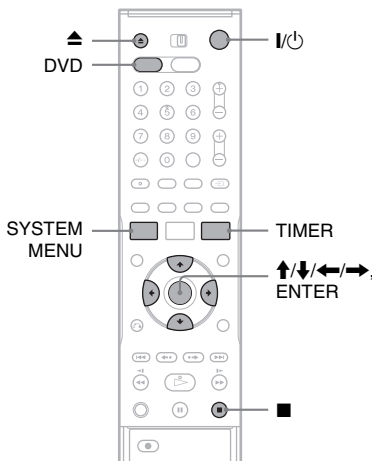

- 1 Press DVD to operate the DVD recorder.

2 Press ▲ (open/close), and place a recordable disc on the disc tray.

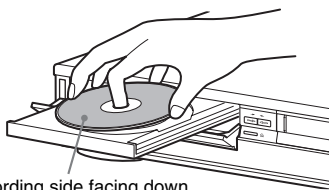

Recording side facing down

3 Press ▲ to close the disc tray.

Wait until “LOAD” disappears from the front panel display.

Unused DVD-RWs are formatted in VR mode automatically. To format in Video mode, see page 105.

4 Press TIMER.

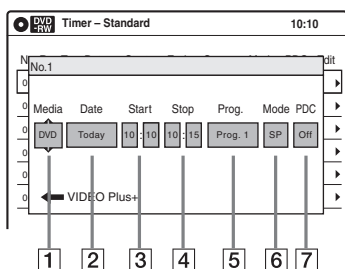

• If the Timer programming (VIDEO Plus+) menu appears, press ← to switch the display to “Standard.”

5 Select an item using ←/→ and adjust using ↑/↓.

1 “Media”: Select “DVD.”

2 “Date”: Sets the date using ↑.
 To record the same programme every day or the same day every week, press ↓.
 The item changes as follows:
 Today ↔ Sun~Sat (Sunday to Saturday)
 ↔ Mon~Sat (Monday to Saturday) ↔
 Mon~Fri (Monday to Friday) ↔ Sun
 (every Sunday) ↔ Mon (every Monday)
 ↔ ... ↔ Sat (every Saturday) ↔
 1 month later ↔ ... ↔ Today

3 “Start”: Sets the start time.

4 “Stop”: Sets the stop time.

5 “Prog.”: Selects the programme position or input source.

6 “Mode”: Selects the recording mode (page 47).

To use the Rec Mode Adjust function (page 52), select “AUTO.”

7 “PDC”: Sets the PDC function. See “About the PDC function” (page 52).

• If you make a mistake, select the item and change the setting.

6 Press ENTER.

The Timer List menu (page 55) appears.

If timer settings overlap, a message appears. To change or cancel a timer recording, select “Edit” from the Timer List (page 55).

7 Press SYSTEM MENU to turn off the menu.

8 Press I/⏻ (on/standby) to turn off the recorder.

The ⊖ indicator lights up in the front panel display, and the recorder is ready to start recording.

If the ⊖ indicator flashes in the front panel display, check that a recordable disc is inserted and that there is enough disc space for the recording.

To stop recording

Press ■ twice.

Note that it may take a few seconds for the recorder to stop recording.

If timer settings overlap

The programme that starts first has priority and the second programme starts recording only after the first programme has finished.

If the programmes start at the same time, the programme listed first in the menu has priority. If the end time of one setting and the start time of another timer setting is the same, the beginning of the programme that starts later will be cut.

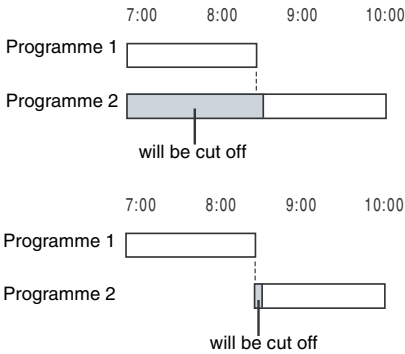

To change or cancel timer recording

See “Changing or Cancelling DVD Timer Settings (Timer List)” on page 55.

To use the Rec Mode Adjust function

If the remaining disc space is not enough for the current recording, the recorder automatically adjusts the recording mode. Select “AUTO” for “Mode” when setting the timer.

About the PDC function

PDC signals are transmitted with TV programmes in some broadcast systems. These signals ensure that timer recordings are made regardless of any broadcast delays, early starts, or broadcast interruptions.

◆ To use the PDC function

Set “PDC” to “On” in step 5 above.

The recorder starts scanning the channel before the timer recording starts.

💡 Hints

- You can play the recorded programme by selecting the programme title in the Title List menu (page 39).
- You can use the recorder after setting the timer. Just press **I/⏻** to turn on the recorder. Turn off the recorder to return it to recording standby before the timer recording starts.
- When the start time and the programme position or input source to be recorded are the same but the “Media” setting differs, the programme is recorded to both the DVD disc and the VHS tape.
- You can also turn on the timer programming menu from the System Menu. Press **SYSTEM MENU** to select “Timer,” and select “Timer-Standard.”

Notes

- To record a satellite programme, turn on the satellite tuner and select the satellite programme you want to record. Leave the satellite tuner turned on until the recorder finishes recording. If you connect equipment with a timer function, you can use the Synchro Rec function (page 54).
- Even when correctly set, the programme may not be recorded if another recording is underway, or other prioritized timer setting overlaps.
- Before the timer recording starts, “TIMER REC” flashes in the front panel display.
- The recorder automatically turns off when a timer recording finishes.
- The recorder does not record programmes with Copy-Never signals. Such recordings stop after a few seconds.
- The beginning of some recordings may not be made when using the PDC function.

Recording TV programmes using the VIDEO Plus+ system

The VIDEO Plus+ system is a feature that simplifies setting the timer. Just enter the PlusCode number listed in the TV programme guide. The date, time, and programme position of that programme are set automatically.

Check that the channels are correctly set in the “Tuner Preset” setup (page 98).

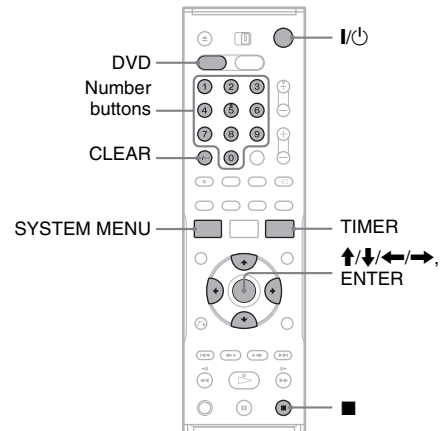

- 1 Press DVD to operate the DVD recorder.
- 2 Insert a recordable disc.
- 3 Press TIMER.

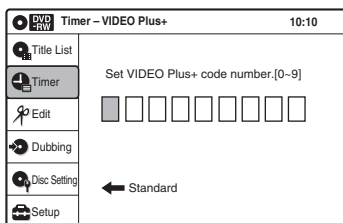

- If the Timer programming (Standard) menu appears, press ← to switch the display to “VIDEO Plus+.”
- 4 Press the number buttons to enter the PlusCode number.
 - If you make a mistake, press CLEAR and re-enter the correct number.
- 5 Press ENTER.

The date, start and stop times, programme position, recording mode, PDC setting (page 52), etc. appear.

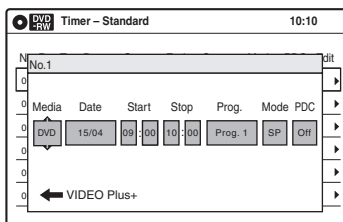

- If you want to change the setting, press ←/→ to select the item and press ↑/↓ to change the setting.
- 6 Select “DVD” for “Media” and press ENTER.
- The Timer List menu (page 55) appears. If timer settings overlap, a message appears. To change or cancel a timer recording, select “Edit” from the Timer List (page 55).
- 7 Press SYSTEM MENU to turn off the menu.
 - 8 Press I/⏻ (on/standby) to turn off the recorder.

The ⊖ indicator lights up in the front panel display, and the recorder is ready to start recording.

If the ⊖ indicator flashes in the front panel display, check that a recordable disc is inserted and that there is enough disc space for the recording.

To stop recording

Press ■ twice.

Note that it may take a few seconds for the recorder to stop recording.

If the timer settings overlap

See page 51.

To change or cancel timer recording

See “Changing or Cancelling DVD Timer Settings (Timer List)” on page 55.

Hints

- You can play the recorded programme by selecting the programme title in the Title List menu.
- You can use the recorder after setting the timer. Just press I/⏻ to turn on the recorder. Turn off the recorder to return it to recording standby before the timer recording starts.
- When the start time and the programme position or input source to be recorded are the same but the “Media” setting differs, the programme is recorded to both the DVD disc and the VHS tape.
- You can also turn on the timer programming menu from the System Menu. Press SYSTEM MENU to select “Timer,” and select “Timer - VIDEO Plus+.”

Notes

- To record a satellite programme, turn on the satellite tuner and select the satellite programme you want to record. Leave the satellite tuner turned on until the recorder finishes recording. If you connect equipment with a timer function, you can use the Synchro Rec function (page 54).
- Even when correctly set, the programme may not be recorded if another recording is underway, or other prioritized timer setting overlaps.
- Before the timer recording starts, “TIMER REC” flashes in the front panel display.
- The recorder automatically turns off when a timer recording finishes.
- The recorder does not record programmes with Copy-Never signals. Such recordings stop after a few seconds.
- The beginning of some recordings may not be made when using the PDC function.

Recording From Connected Equipment With a Timer (Synchro Rec)

+RW -RWVR -RW_{video} +R -R

You can set the recorder to automatically record programmes from connected equipment that has a timer function (such as a satellite tuner). Connect the equipment to the LINE 3/DECODER jack on the rear of the recorder (page 28).

When the connected equipment turns on, the recorder starts recording a programme from the LINE 3/DECODER jack.

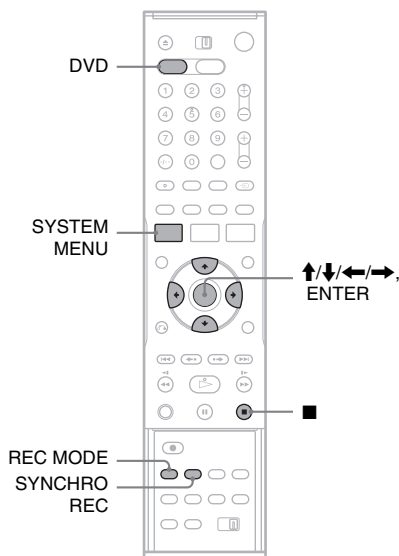

- 1** Press DVD to operate the DVD recorder.
- 2** Insert a recordable disc.
- 3** Select the line input audio.
Set "Line Audio Input" to "Stereo" or "Bilingual" in the "Audio" setup (page 104).

- 4** Press REC MODE repeatedly to select the recording mode.

The display changes on the TV screen as follows:

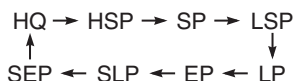

For details about the recording mode, see page 47.

- 5** Press SYSTEM MENU while the recorder is in stop mode.
- 6** Select "Setup," and press ENTER.
- 7** Select "Features," and press ENTER.
The "Features" setup appears.
- 8** Select "Synchro Recording," and press ENTER.
- 9** Select "to DVD," and press ENTER.
- 10** Press SYSTEM MENU to turn off the menu.
- 11** Set the timer on the connected equipment to the time you want to record, and turn it off.
- 12** Press SYNCHRO REC.

The SYNCHRO REC indicator lights up on the front panel and the recorder stands by for Synchro-Rec.

The recorder starts recording when a signal is received from the connected equipment.

When the connected equipment turns off, the recording stops and the recorder turns off.

To stop recording

Press ■ twice.

To cancel Synchro Rec function

Press SYNCHRO REC before recording starts. The SYNCHRO REC indicator on the recorder turns off.

If you press SYNCHRO REC during Synchro-Rec, the recording stops, the SYNCHRO REC indicator turns off, and the recorder turns off.

If the timer settings of a Synchro-Recording and another timer recording overlap

Regardless of whether or not the programme is a Synchro-Rec programme, the programme that starts first has priority. The recorder starts recording the second programme about ten seconds after the first programme has finished. If the end time of one setting and the start time of another timer setting is the same, the beginning of the programme that starts later will be cut.

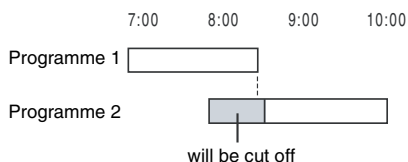

Notes

- The recorder starts recording only after detecting the video signal from the connected equipment. The beginning of the programme may not be recorded regardless of whether or not the recorder's power is on or off.
- To use the connected equipment during Synchro-Rec standby, cancel the standby mode by pressing SYNCHRO REC. To return to standby mode again, be sure to turn off the equipment and press SYNCHRO REC, before Synchro-Rec starts.
- The Synchro-Rec function does not work with some tuners. For details, see the tuner's operating instructions.
- During Synchro-Rec standby, the Auto Clock Set function does not work (page 100).
- After a recording has finished, the recorder enters the Synchro-Rec standby mode until the SYNCHRO REC indicator turns off.
- If Synchro-Rec starts with the recorder turned on, the recorder will turn off when the recording ends.
- The recorder does not record programmes with Copy-Never signals. Such recordings stop after a few seconds.

Changing or Cancelling DVD Timer Settings (Timer List)

+RW -RWVR -RW_{Video} +R -R

You can change or cancel timer settings using the Timer List menu.

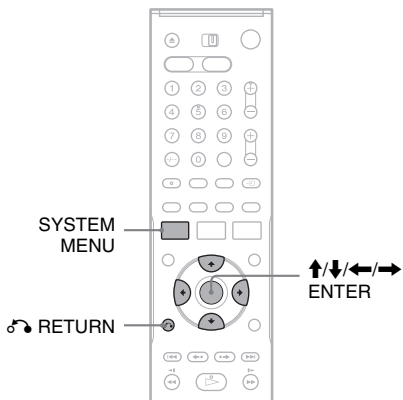

- 1 Press **SYSTEM MENU**.
The System Menu appears.
- 2 Select **"Timer,"** and press **ENTER**.
- 3 Select **"Timer List,"** and press **ENTER**.

No	Media	Date	Start	Stop	Prog.	Mode	PDC	Edit
01	DVD	15/04	09:00	10:00	Prog. 1	SP	Off	▶
02	DVD	30/04	09:15	09:45	Prog. 2	SP	Off	▶
03	---	--/--	--:--	--:--	----	---	--	▶
04	---	--/--	--:--	--:--	----	---	--	▶
05	---	--/--	--:--	--:--	----	---	--	▶
06	---	--/--	--:--	--:--	----	---	--	▶

Timer information displays the recording date, time, recording mode, etc. If there are more than six timer settings, press ↓ to display the next page.

4 Select the timer setting you want to change or cancel, and press ENTER.

The sub-menu appears.

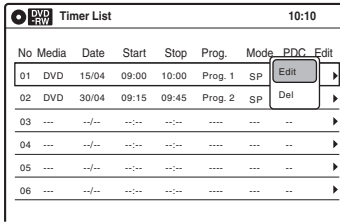

prioritized timer setting overlaps. For priority, see page 51.

- You cannot change the timer settings for a recording currently underway.
- The Timer List displays both the DVD recorder and VCR timer settings.

5 Select one of the options, and press ENTER.

“Edit”: Changes the timer setting.

Select an item using ←/→ and adjust using ↑/↓. Press ENTER.

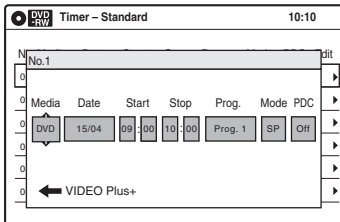

“Del”: Erases the timer setting.

Select “OK” and press ENTER when asked for confirmation.

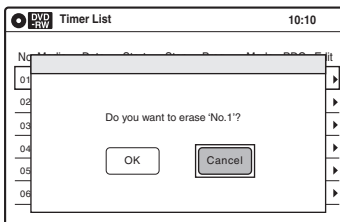

6 Press SYSTEM MENU to turn off the Timer List.

If any settings remain, turn off the recorder to return it to recording standby.

To return to the previous display

Press ⏪ RETURN.

Notes

- Even when correctly set, the programme may not be recorded if another recording is underway, or other

Recording From Connected Equipment Without a Timer

+RW -RWV R -RW_{Video} +R -R

You can record from a connected VCR or similar device. For connection details, see “Connecting Another VCR or Similar Device” on page 26. Use the DV IN jack on the front panel if the equipment has a DV output jack (i.LINK jack). To record from a digital video camera connected to the DV IN jack, see page 93.

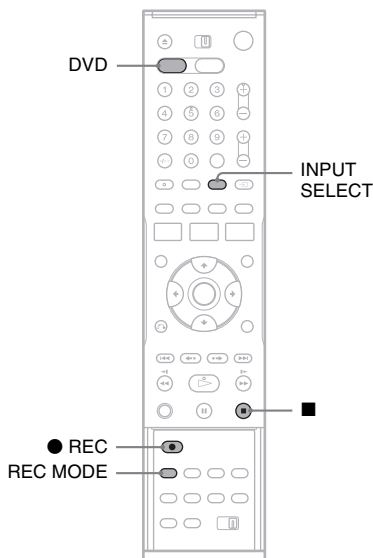

- 1** Press DVD to operate the DVD recorder.
- 2** Insert a recordable disc.
- 3** Press INPUT SELECT repeatedly to select an input source according to the connection you made.

The front panel display changes as follows:

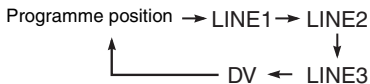

- 4** Press REC MODE repeatedly to select the recording mode.

The display changes on the TV screen as follows:

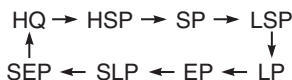

For details about the recording mode, see page 47.

- 5** Select the line input audio. Set “Line Audio Input” to “Stereo” or “Bilingual” in the “Audio” setup (page 104).
- 6** Insert the source tape into the connected equipment and set to playback pause.
- 7** Press ● REC on this recorder and the pause or play button on the connected equipment at the same time.

Recording starts.

To stop recording, press ■ on this recorder.

Notes

- A video game image may not be recorded clearly.
- The recorder does not record programmes with Copy-Never signals. Such recordings stop after a few seconds.
- During recording or recording pause, you cannot change the recording mode.
- You cannot change the programme position or input source during recording.

Before Editing

This recorder offers various edit options for various disc types. Before you edit, check the disc type in the front panel display, and select the option available for your disc (page 30).

Note

You may lose the edited contents if you remove the disc or a timer recording starts while editing.

Edit options for DVD+RWs/DVD-RWs (Video mode)/DVD+Rs/DVD-Rs

+RW -RW_{Video} +R -R

You can perform simple edits. Since Video mode titles are actual recordings on the disc, you cannot undo any edits you make. The edit functions available for Video mode titles are:

- Renaming a title (page 63).
- Erasing a title (page 59).
- Setting protection against erasure (DVD+RWs only) (page 59).
- Dividing a title (DVD+RWs only) (page 61).

Notes

- Once the disc is finalized, you cannot edit or record on the disc (except for DVD+RWs).
- If a message appears and indicates that the disc's control information is full, erase unnecessary titles.

Edit options for DVD-RWs (VR mode)

-RW_{VR}

You can enjoy advanced edit functions. First you have two options for a DVD-RW (VR mode): editing either the original recording (called the “original”), or the playback information created from the original (called a “Playlist”). Since each is different in nature and offers different merits, read the following and select the one that better suits your needs.

To edit original titles

Edits made to the original titles are final. If you plan to retain an unaltered original recording,

create and edit a Playlist (see below). The edit functions available for original titles are:

- Renaming a title (page 63).
- Erasing a title (page 59).
- Erasing a chapter (page 60).
- Setting protection against erasure (page 59).
- Erasing a section of a title (A-B Erase) (page 60).
- Dividing a title (page 61).

To create and edit Playlist titles

A Playlist is a group of Playlist titles created from the original title for editing purposes. When you create a Playlist, only the control information necessary for playback, such as the playback order, is stored on the disc. Since the original titles are left unaltered, Playlist titles can be re-edited. If you erase an original title used in a Playlist, that Playlist is also erased.

Example: You have recorded the final few matches of a soccer tournament on a DVD-RW (VR mode). You want to create a digest with the goal scenes and other highlights, but you also want to keep the original recording.

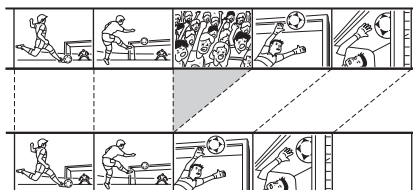

In this case, you can compile highlight scenes as a Playlist title. You can even rearrange the scene order within the Playlist title. See “Editing a Playlist” on page 65.

The advanced edit functions available for Playlist titles are:

- Renaming a title (page 63).
- Erasing a title (page 59).
- Erasing a chapter (page 60).
- Erasing a section of a title (A-B Erase) (page 60).
- Editing a Playlist scene (page 65).
- Dividing a title (page 61).
- Combining titles (page 66).

Hint

You can switch the Title List to show original or Playlist. While the Title List menu is turned on, press ORIGINAL/PLAYLIST repeatedly.

Notes

- You cannot protect Playlist titles.
- If a message appears and indicates that the disc's control information is full, erase unnecessary titles.

Editing a Title

+RW -RW/VR -RW/video +R -R

This section explains the basic edit functions. Note that editing is irreversible. To edit a DVD-RW (VR mode) without changing the original recordings, create a Playlist title (page 64).

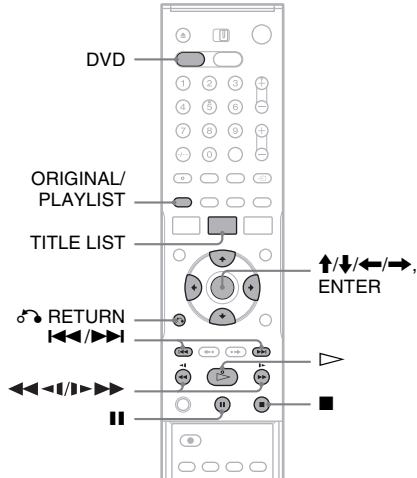

1 Press DVD to operate the DVD recorder.

2 Press TITLE LIST.

When editing a DVD-RW (VR mode), press ORIGINAL/PLAYLIST to switch to the "Title List (Original)," if necessary.

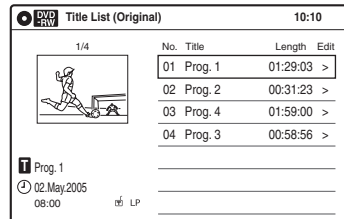

3 Select a title, and press ENTER.

The sub-menu appears.

4 Select an option, and press ENTER.

You can select from the following:

“Title Erase”: Erases the selected title. Select “OK” when asked for confirmation.

“Chapter Erase”^{*1}: Allows you to select a chapter in the title and erase it (see below).

“Protect”^{*2}: Protects the title. Select “On” when the Protection display appears. “

“Title Name”: Allows you to rename the title (page 63).

“A-B Erase”^{*1}: Erases a section of the title (page 60).

“Divide Title”^{*2}: Divides a title into two (page 61).

^{*1}DVD-RWs (VR mode) only

^{*2}DVD+RWs and DVD-RWs (VR mode) only

Hints

- You can also rename a disc (page 69).
- For a DVD+R or DVD-R, erasing titles does not free up disc space. For a DVD+RW or DVD-RW (Video mode), you can free up space only by erasing the last title.

Notes

- When editing a DVD-RW (Video mode), DVD+R, or DVD-R, finish all editing before finalizing the disc. You cannot edit a finalized disc.
- You cannot erase protected titles or erase chapters from a protected title.
- If you erase an original title used in a Playlist, that Playlist is also erased.

Erasing a chapter (Chapter Erase)

-RWVR

You can select a chapter within a title and erase it. Note that erasing chapters from original titles cannot be undone.

1 Press TITLE LIST.

Press ORIGINAL/PLAYLIST to switch to the “Title List (Original),” if necessary.

2 Select a title, and press ENTER.

The sub-menu appears.

3 Select “Chapter Erase,” and press ENTER.

The display for erasing chapters appears.

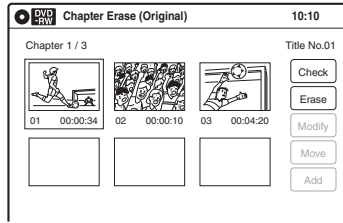

4 Select the chapter you want to erase, and press ENTER.

“Check” is selected. To preview the chapter, press ENTER. When playback finishes or when you press  RETURN, the display returns to “Chapter Erase (Original).”

5 Select “Erase,” and press ENTER.

The display asks for confirmation.

6 Select “OK,” and press ENTER.

The selected chapter is erased from the title.

To erase other chapters, repeat from step 4.

Hint

You can also erase chapters from a Playlist title (page 65).

Note

If you erase an original title used in a Playlist, that Playlist is also erased.

Erasing a section of a title (A-B Erase)

-RWVR

You can select a section (scene) within a title and erase it. Note that erasing scenes from original titles cannot be undone.

1 Press TITLE LIST.

Press ORIGINAL/PLAYLIST to switch to the “Title List (Original),” if necessary.

2 Select a title, and press ENTER.

The sub-menu appears.

3 Select “A-B Erase,” and press ENTER.

The display for setting point A and B appears.

“Start” is selected.

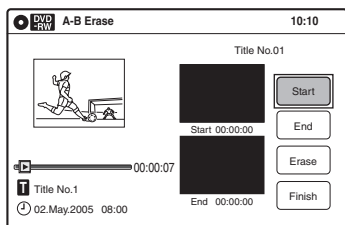

4 Press ENTER at the start point of the section to be erased (point A).

You can use \triangleright , \lll , $\lll|$, $|$, \lll , $\lll|$, \blacksquare , and \lll to find the point. “End” is selected.

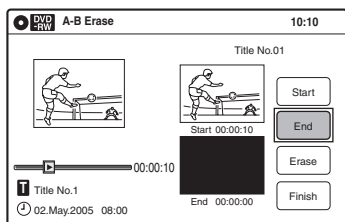

5 Press ENTER at the end point of the section (point B).

“Erase” is selected.

To reset the start or end point, select “Start” or “End” and repeat from step 4 or 5.

6 Press ENTER.

The display asks for confirmation.

7 Select “OK,” and press ENTER.

The scene is erased.

To continue, repeat from step 4. To finish, select “Finish,” and press ENTER.

Hints

- A chapter mark is inserted after the scene was erased. The chapter mark divides the title into separate chapters on either side of the mark.
- You can also erase a section of a Playlist title (page 65).

Notes

- Images or sound may be momentarily interrupted at the point where you erase a section of a title.
- Sections shorter than five seconds may not be erased.
- The start and end points of a title may be different from what you have set.
- The total playing time of the title does not change even if a scene was erased.

- If you erase an original title used in a Playlist, that Playlist is also erased.

Dividing a title into two (Divide Title)

+RW -RWVR

You can divide a title into two. Note that dividing original titles cannot be undone.

1 Press TITLE LIST.

When editing a DVD-RW (VR mode), press ORIGINAL/PLAYLIST to switch to the “Title List (Original),” if necessary.

2 Select a title, and press ENTER.

The sub-menu appears.

3 Select “Divide Title,” and press ENTER.

The display for setting the dividing point appears.

“Point” is selected.

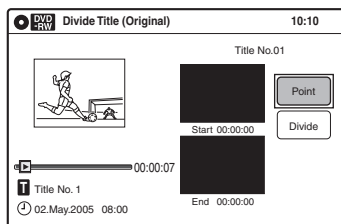

4 Press ENTER at the point where you want to divide the title.

You can use \triangleright , \lll , $\lll|$, $|$, \lll , $\lll|$, \blacksquare , and \lll to find the point. “Divide” is selected.

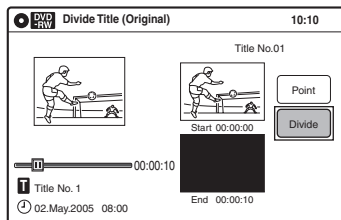

5 Press ENTER.

The display asks for confirmation.

To reset the dividing point, select “No” and press ENTER, then repeat from step 4.

6 Select “Yes,” and press ENTER.

The display asks whether to use the same title name as before.

To use the same name, select “Yes” and press ENTER to finish.

7 Select “No,” and press ENTER.

The display asks whether to rename the title.

8 Select “Yes,” and press ENTER.

The “Title Name” display appears.

9 Follow steps 5 to 7 of “Changing the Name of a Title” (page 63) to complete renaming.

The divided title appears in the Title List with the new name.

Hint

You can also divide a Playlist title (page 65).

Creating chapters manually

+RW **-RWVR**

You can manually insert a chapter mark at any point you like during playback.

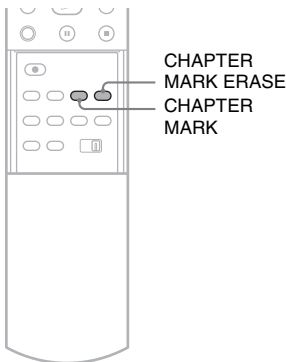

Press CHAPTER MARK at the point where you want to divide the title into chapters.

Each time you press the button, “Marking...” appears on the screen and the scenes before and after the mark become separate chapters.



To erase chapter marks

You can combine two chapters by erasing the chapter mark during playback.

During playback, press CHAPTER MARK ERASE.

The current chapter combines with the previous chapter.

Notes

- If a message appears and indicates that no more chapter marks can be added, you may not be able to record or edit.
- You cannot add or erase chapter marks on protected titles or discs.

Changing the Name of a Title

+RW **-RWVR** **-RW_{Video}** **+R** **-R**

You can enter a title name of up to 32 characters. Since the displayed number of characters is limited, their appearance in menus such as Title List may be different. When the display for entering characters appears, follow the steps below.

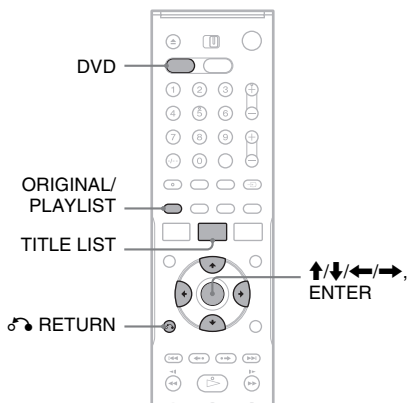

1 Press DVD to operate the DVD recorder.

2 Press TITLE LIST.

When editing a DVD-RW (VR mode), press ORIGINAL/PLAYLIST to switch to the “Title List (Original),” if necessary.

3 Select a title, and press ENTER.

The sub-menu appears.

4 Select “Title Name,” and press ENTER.

The “Title Name” display appears.

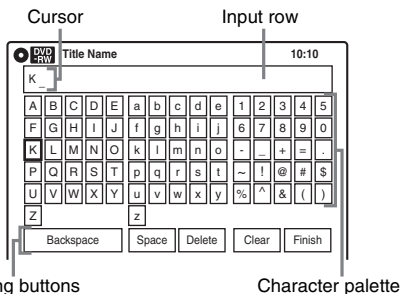

5 Select the character you want to enter using $\uparrow/\downarrow/\leftarrow/\rightarrow$ and press ENTER.

The selected character appears in the input row.

You can only enter characters and symbols that are displayed.

- To change the cursor position, select the input row using \uparrow , and press \leftarrow/\rightarrow .
- To erase a character, select either of the following setting buttons and press ENTER.
 - “Backspace”: Erases the character to the left of the cursor.
 - “Delete”: Erases the character at the cursor position.
 - “Clear”: Erases all the characters in the input row.
- To insert a space, move the cursor to the desired position, select “Space,” and press ENTER.
- To insert a character, move the cursor to the desired position, select the character and press ENTER.

6 Repeat step 5 to enter the remaining characters.

To return to the Title List without renaming the title, press \hookrightarrow RETURN.

7 Select “Finish,” and press ENTER.

Hint

You can also rename a disc (page 69). Follow steps 5 to 7 above when the “Disc Name” display appears.

Creating a Playlist

-RWVR

Playlist titles allow you to edit without changing the original recordings (see “Edit options for DVD-RWs (VR mode)” on page 58). You can create a Playlist title by combining up to 99 sections (scenes) from original titles.

Note

If you erase an original title used in a Playlist, that Playlist is also erased.

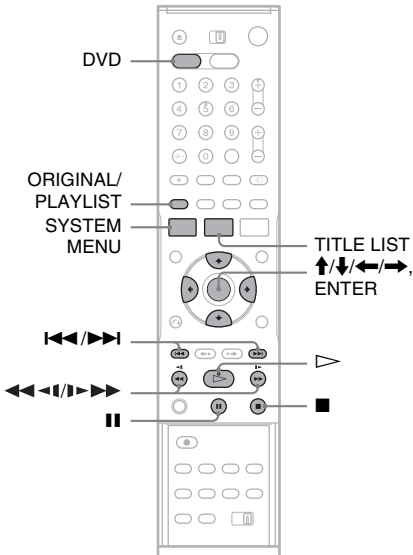

- 1 Press DVD to operate the DVD recorder.
- 2 Press SYSTEM MENU while the recorder is in stop mode.

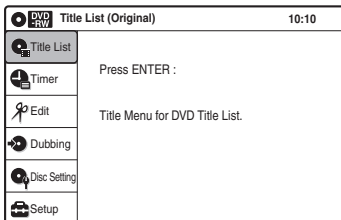

- 3 Select “Edit,” and press ENTER.

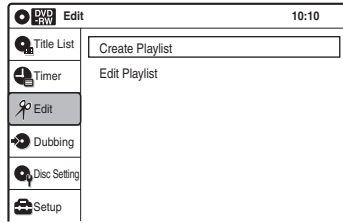

- 4 Select “Create Playlist,” and press ENTER. The display for creating a Playlist appears. “Start” is selected.

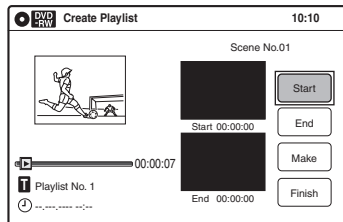

- 5 Press ENTER at the start point. You can use \blacktriangleleft , \blacktriangle , $\blacktriangleleft\blacktriangleleft$, $\blacktriangleright\blacktriangleright$, $\blacktriangleleft\blacktriangleleft\blacktriangleleft$, $\blacktriangleright\blacktriangleright\blacktriangleright$, and $\blacktriangle\blacktriangle$ to find the point. “End” is selected.

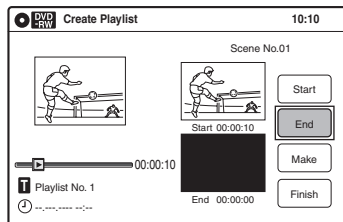

- 6 Press ENTER at the end point. “Make” is selected. To reset the start or end point, select “Start” or “End” and repeat step 5 or 6.
- 7 Press ENTER. The selected section is captured as a scene. To continue, repeat from step 5.
- 8 When you finish capturing scenes, select “Finish” and press ENTER.

Playing a Playlist title

- 1 Press **TITLE LIST**.
- 2 Press **ORIGINAL/PLAYLIST** to switch to the “Playlist” Title List.
- 3 Select a Playlist title, and press **ENTER**.
The sub-menu appears.
- 4 Select “Play,” and press **ENTER**.

Hint

When a Playlist title is created, the start and end points will become chapter marks, and each scene will become a chapter.

Notes

- The picture may pause when an edited scene is played.
- The start and end points in a title may be different from what you have set.

Editing a Playlist

-RWVR

You can edit Playlist titles or scenes within them, without changing the actual recordings.

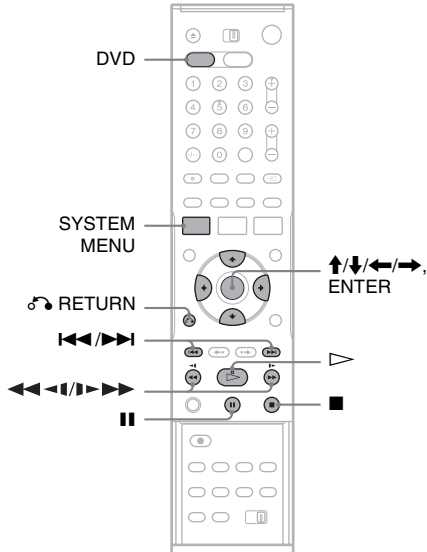

DVD Editing

- 1 Press **DVD** to operate the DVD recorder.
- 2 Press **SYSTEM MENU** while the recorder is in stop mode.

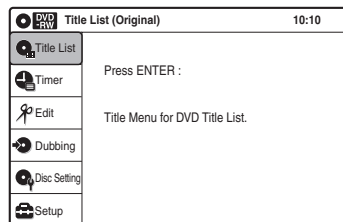

- 3 Select “Edit,” and press **ENTER**.

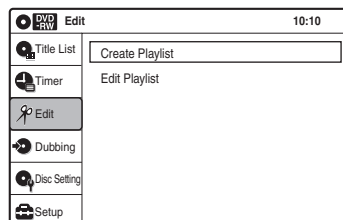

4 Select “Edit Playlist,” and press ENTER.

The “Playlist” Title List appears.

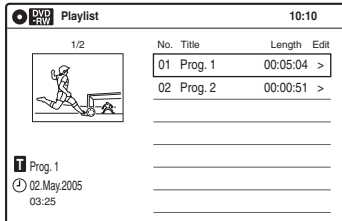

5 Select a Playlist title, and press ENTER.

The sub-menu appears.

6 Select an option, and press ENTER.

Select from the following options. For details, see the pages in parentheses.

“Title Erase”: Erases the title. Select “OK” when asked for confirmation.

“Chapter Erase”: Allows you to select chapters in the Playlist title to erase (page 60).

“Title Name”: Allows you to rename the title (page 63).

“A-B Erase”: Allows you to select sections in the title to erase (page 60).

“Edit Scene”: Allows you to re-edit scenes in the Playlist title. Go to step 7.

“Divide Title”: Divides the title in two at a desired point (page 61).

“Combine Titles”: Allows you to combine two titles into one (page 66).

7 Select “Edit Scene,” and press ENTER.

The display for editing scenes appears.

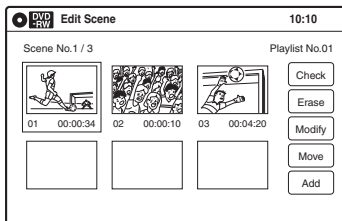

“Check”: Allows you to preview a scene. Starts playback of the selected scene when you press ENTER. The display returns to the “Edit Scene” display when the playback finishes or when you press RETURN.

“Erase”: Erases a scene (page 67).

“Modify”: Allows you to change the start and end point of a scene (page 67).

“Move”: Allows you to change scene order (page 67).

“Add”: Allows you to add other scenes before a selected scene (page 68).

To return to the previous display

Press RETURN.

To turn off the display

Press SYSTEM MENU.

Hint

The Resume Play function will work for scene playback.

Combining two titles into one (Combine Titles)

-RWVR

You can select a Playlist title and combine it with another Playlist title.

1 Follow steps 1 to 5 of “Editing a Playlist” (page 65) to select a Playlist title.

The sub-menu appears.

2 Select “Combine Titles,” and press ENTER.

The next title below is also selected.

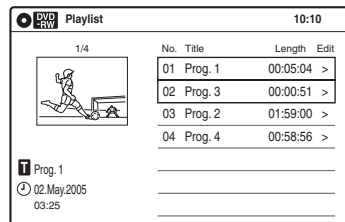

3 Select a Playlist title to be combined.

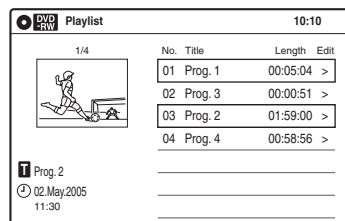

4 Press ENTER.

The display asks for confirmation.

5 Select “Yes,” and press ENTER.

The display asks whether to use the same title name as before.

To use the same name, select “Yes” and press ENTER to finish.

6 Select “No,” and press ENTER.

The display appears to confirm to rename the title.

7 Select “Yes,” and press ENTER.

The “Title Name” display appears.

8 Follow steps 5 to 7 of “Changing the Name of a Title” (page 63) to complete renaming.

The two Playlist titles become one Playlist title with the new name.

Erasing a scene (Erase)

-RWVR

You can erase a selected scene.

1 Follow steps 1 to 7 of “Editing a Playlist” (page 65).

2 Select a scene in the “Edit Scene” display and press ENTER.

3 Select “Erase,” and press ENTER.

The display asks for confirmation.

4 Select “OK,” and press ENTER.

The selected scene is erased.

To erase other scenes, repeat from step 2.

Modifying a scene (Modify)

-RWVR

You can change the start and end point of the selected scene.

1 Follow steps 1 to 7 of “Editing a Playlist” (page 65).

2 Select a scene in the “Edit Scene” display and press ENTER.

3 Select “Modify,” and press ENTER.

“Start” is selected.

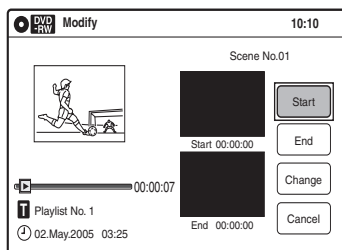

4 Press ENTER at the start point.

You can use \triangleright , \lll , $\lll|$, $|$, $|>>>$, $\lll|>>>$, $\lll|>>>$, and $\lll|>>>$ to find the point.

“End” is selected.

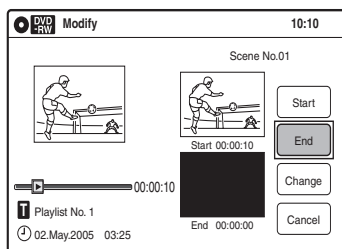

5 Press ENTER at the end point.

“Change” is selected.

To reset the start or end point, select “Start” or “End” and repeat step 4 or 5.

6 Press ENTER.

The display returns to the “Edit Scene” display.

The re-selected section is captured as a scene. To modify other scenes, repeat from step 2.

To cancel modifying

Select “Cancel,” and press ENTER.

Note

The start and end point of a scene may be different from what you have set.

Moving a scene (Move)

-RWVR

You can change the scene order within the Playlist title.

- 1 Follow steps 1 to 7 of “Editing a Playlist” (page 65).
- 2 Select a scene in the “Edit Scene” display and press ENTER.
- 3 Select “Move,” and press ENTER.

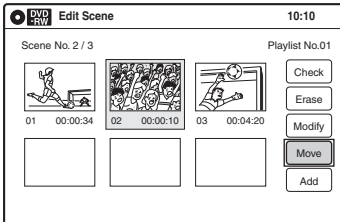

- 4 Select a new location using ←/→, and press ENTER.
The selected scene moves to the new location.
To move other scenes, repeat from step 2.

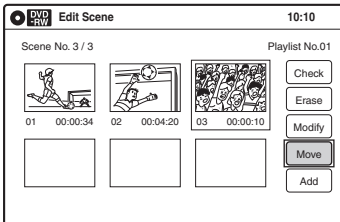

Adding a scene (Add)

-RWVR

You can add a scene before the selected scene.

- 1 Follow steps 1 to 7 of “Editing a Playlist” (page 65).
- 2 Select a scene in the “Edit Scene” display, and press ENTER.
- 3 Select “Add,” and press ENTER.

“Start” is selected.

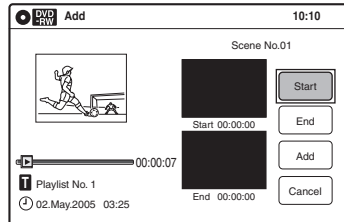

- 4 Press ENTER at the start point.
You can use ▷, ◀◀◀, ▶▶▶, ◀◀◀, ▶▶▶, ■, and || to find the point.
“End” is selected.

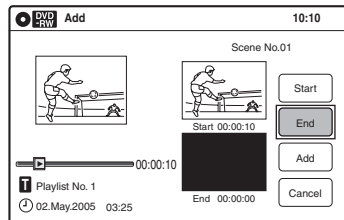

- 5 Press ENTER at the end point.
“Add” is selected.
To reset the start or end point, select “Start” or “End” and repeat step 4 or 5.

- 6 Press ENTER.

The display returns to the “Edit Scene” display.
The selected section is added before the selected scene.
To add other scenes, repeat from step 2.

To cancel adding

Select “Cancel,” and press ENTER.

Note

The start and end point of a scene may be different from what you have set.

Formatting/Renaming/ Protecting a Disc

+RW -RWVR -RWVideo +R -R

The “Disc Setting” display allows you to check the disc information or change the disc name. Depending on the disc type, you can also format or set protection.

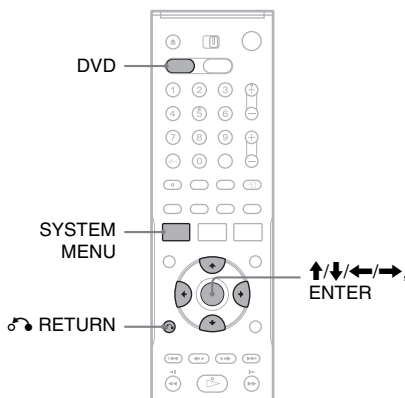

- 1 Press DVD to operate the DVD recorder.
- 2 Press SYSTEM MENU while the recorder is in stop mode.
- 3 Select “Disc Setting,” and press ENTER. The “Disc Setting” display appears.

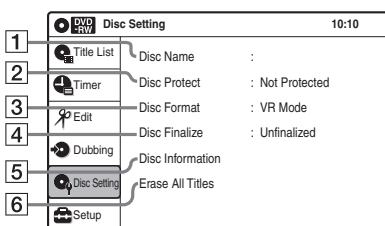

4 Select an option, and press ENTER.

- 1 “Disc Name”: Allows you to rename a disc. For details on how to enter characters, see page 63.
- 2 “Disc Protect” (DVD-RWs (VR mode) only): Protects all titles on the disc when “Protected” is selected. To cancel the protection, select “Not Protected.”

- 3 “Disc Format” (DVD+RWs/DVD-RWs only): Erases all contents of the disc, including protected titles, and makes a blank disc. For DVD-RWs, select a recording format (“VR Mode” or “Video Mode”) according to your needs.
- 4 “Disc Finalize”: Finalizes a disc. See page 91 for details.
- 5 “Disc Information”: Displays the following information.
 - Disc name
 - Disc type (and recording format for a DVD-RW)
 - Total number of titles
 - Protect setting
 - The oldest and most recent recording date
 - The total available recording time in each recording mode.

Disc Information		10:10	
Disc Name	Disc 1		
Media	DVD-RW	Format	VR Mode
Title No.	Original 6 / Playlist 1		
Protected	Not Protected		
Date	5.04.2005 ~ 30.04.2005		
Remainder	HQ : 0H 57M	HSP : 1H 26M	SP : 1H 55M
	LSP : 2H 23M	LP : 2H 52M	EP : 3H 50M
	SLP : 5H 46M	SEP : 7H 40M	4.4/4.7GB

- 6 “Erase All Titles” (DVD+RWs/DVD-RWs only): Erases all titles on the disc (except protected titles). Select “OK” when asked for confirmation. For DVD-RWs (VR mode), Playlists created with protected titles are also erased.

To return to the previous display

Press RETURN.

Hints

- You can set protection for individual titles (page 59).
- By reformatting, you can change the recording format on DVD-RWs, or record again on DVD-RWs (Video mode) that have been finalized.

Note

You can label a disc using up to 32 characters; however, the name may not display on other DVD equipment.

VCR Playback

Playing

VHS

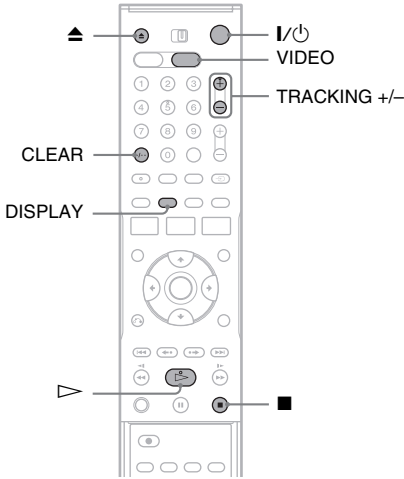

1 Press VIDEO to operate the VCR.

2 Insert a tape.

Playback starts automatically if you insert a tape with its safety tab removed.

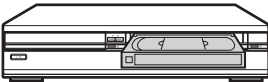

3 Press ▷ (play).

The front panel display shows the playing time.

When the tape reaches the end, it will rewind automatically.

To stop playback

Press ■ (stop).

To eject the tape

Press ▲ (eject).

To turn off the power while rewinding (Rewind Shut Off)

Press I/⏻ while the tape is rewinding. The power will turn off but the tape will keep rewinding until it reaches the end.

To use the time counter

Press CLEAR at the point where you want to find later. The counter in the front panel display resets to “0:00:00.”

To search for the 0:00:00 point automatically, see page 73.

To display the counter on the TV screen, press DISPLAY.

Notes

- During playback, the VCR automatically detects the recording system and the recording mode, SP (Standard Play) or LP (Long Play), from the tape. EP (Extended Play) mode recordings made on other equipment will play, but picture quality is not guaranteed.
- The counter resets to “0:00:00” whenever a tape is reinserted.
- The counter stops counting when it comes to a portion with no recording.
- When playback does not start even if you insert a tape with its safety tab removed, set “VCR Function” – “Auto Play” to “On” in the “Features” setup (page 105).
- If you switch to the VCR while playing a disc, DVD playback stops.
- If you play back a tape in LP or EP mode with the NTSC system, the sound becomes monaural.
- For simultaneous VHS and DVD operation, see page 9.

Adjusting the picture (tracking)

You can manually adjust tracking if the recording quality is too poor to be remedied by the VCR's automatic tracking (a tracking meter appears during the automatic tracking).

Press TRACKING +/-.

The tracking meter appears.

Press TRACKING +/- repeatedly until the distortion disappears.

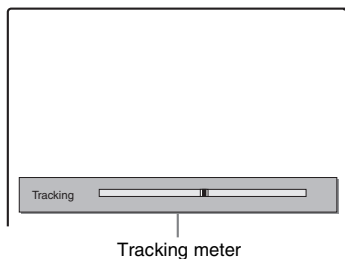



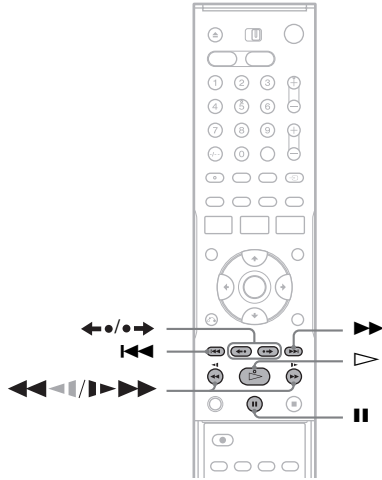

To resume automatic tracking

Press TRACKING + and TRACKING - on the recorder at the same time for more than ten seconds. Or, eject the tape and reinsert it.

Playback Options

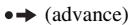
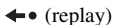

Button	Operation
 (fast reverse/fast forward)	<ul style="list-style-type: none"> • Fast reverses or fast forwards when pressed during stop mode. When you hold down during fast reverse or fast forward, you can view the picture. • Plays at high speed when briefly pressed during playback. When you hold down the button during playback, the high-speed play continues until you release the button.
 (slow)	Plays in slow motion when pressed in pause mode.
 (advance)	<ul style="list-style-type: none"> • Advances one frame for each press in pause mode. • Fast forwards the current scene for 30 seconds when pressed during playback.*1
 (replay)	Replays the previous scene when pressed during playback.*2
 (previous/next)	Press during playback. Playback speed changes with each press: -x7 ↔ -x5 ↔ -x3 ↔ STILL ↔ SLOW ↔ PLAY ↔ x2 ↔ x3 ↔ x5 ↔ x7
 (pause)	Pauses playback. If you pause playback for more than five minutes, playback starts automatically.

*1 Can be pressed up to four times to forward about two minutes.

*2 For 10 seconds in SP or LP mode/for 15 seconds in EP mode.

Notes

- The sound is muted during playback at various speeds.
- The picture may show noise during high-speed reverse play.

To resume normal playback, press .

Searching Using Various Functions

VHS

The VCR automatically marks the tape with an index signal at the point where each recording begins.

You can easily find a specific point using various search functions.

Note

During DVD recording, you cannot use VCR search functions.

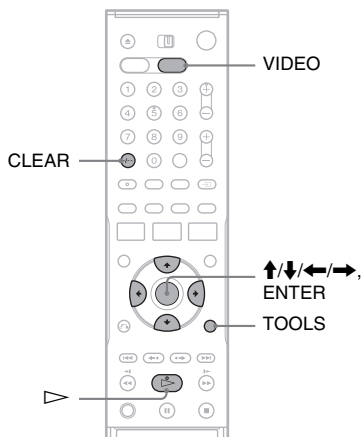

- 1 Press **VIDEO** to operate the VCR.
- 2 Press **TOOLS**.
- 3 Select a search method from the **TOOLS** menu, and press **ENTER**.

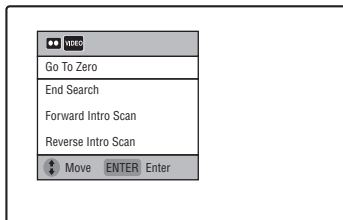

“Go To Zero”: Searches for the 0:00:00 point on the tape counter.
To reset the counter to 0:00:00, press **CLEAR**.

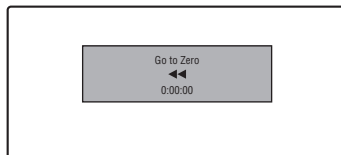

“End Search”: Searches for the beginning of a blank space. If no blank space is found, the tape will reach the end.

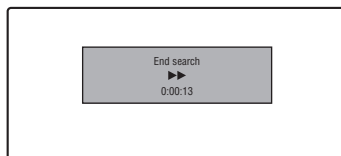

“Forward Intro Scan”/“Reverse Intro Scan”: Searches for an index mark and plays back for about five seconds at that point. Press **▷** (play) to view that programme. If you do not press **▷**, the VCR automatically searches for the next index mark, or until it reaches the end of the tape.

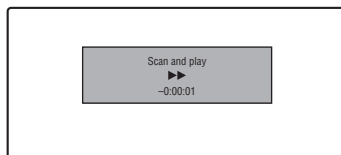

Notes

- The VCR may not recognize the end of a blank space depending on its length.
- No index signal is marked if you pause a recording and then keep recording the same programme. To mark an index, press **■** or change the programme position once during recording pause.

Displaying the Playing Time and Play Information

VHS

You can check playback information, such as elapsed or remaining time, recording mode, etc., on the TV screen.

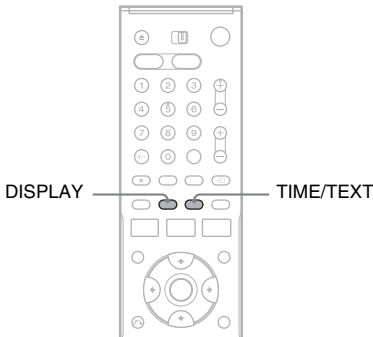

Press DISPLAY during playback.

The information display appears. Each time you press the button, the display changes as follows:

- Tape and disc information/Date and time
- ↓
- Tape information only
- ↓
- No display

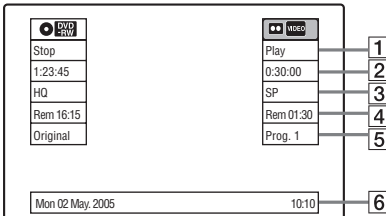

- 1 Playing status
- 2 Time counter (elapsed time)
- 3 Recording mode
- 4 Remaining tape length
- 5 Programme position or input source
- 6 Date and time

Viewing information on the front panel display

You can view the information on the front panel display.

Press TIME/TEXT repeatedly.

The displays differ depending on the status.

Example: When playing a tape

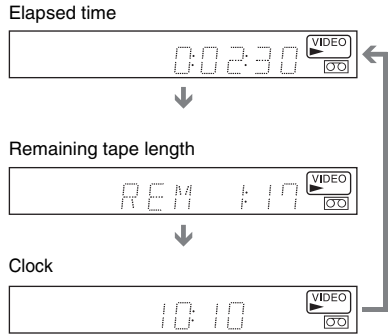

Example: When a tape is in stop mode

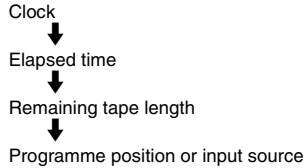

Selecting the Sound During Playback

VHS

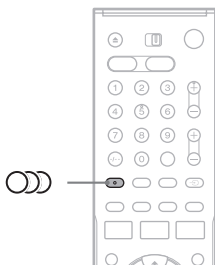

Press  (audio) repeatedly during playback.

To listen to	On-screen display	Front panel display
Stereo	Hi-Fi	STEREO
Left channel	Left	STEREO
Right channel	Right	STEREO
Left and right channels mixed	Mix	STEREO
Monaural sound on the normal audio track	Mono	STEREO*

* No indicator appears on the front panel display when you play a tape without Hi-fi recording.

How sound is recorded on a video tape

The VCR records sound onto two separate tracks. Hi-fi audio is recorded onto the main track along with the picture. Monaural sound is recorded onto the normal audio track along the edge of the tape.

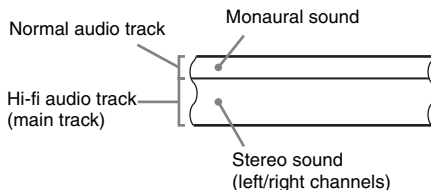

Notes

- To play a tape in stereo, you must use the A/V connections.
- When you play a tape recorded in monaural, the sound is heard in monaural regardless of the  (audio) setting.

Before Recording

Before you start recording...

- This VCR records in VHS format.
- Check that the tape is longer than the recording time (page 74).

Notes

- Timer recordings cannot be made if the recorder is turned on (page 79). The recorder automatically turns off after a recording has finished.
- This recorder shares a single tuner for both the DVD recorder and the VCR. You cannot record different programs to a DVD and a VHS tape at the same time.
- This recorder has the copy guard function. Programmes that contain a Copy-Never copy guard signal cannot be correctly recorded on the VCR.

To save a recording

To prevent accidental erasure, break off the safety tab as illustrated. To record on the tape again, cover the tab hole with adhesive tape.

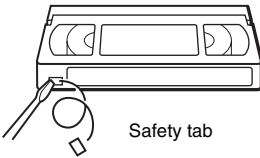

Recording mode

“LP” (Long Play) or “SP” (Standard Play) is available for recording mode (tape speed). “LP” provides recording time two times as long as “SP.” However, “SP” produces better picture and audio quality.

Maximum recording time

Tape Length	SP	LP
E180	3 hrs	6 hrs
E240	4 hrs	8 hrs
E260	4 hrs 20 mins	8 hrs 40 mins
E300	5 hrs	10 hrs

Notes

- Tapes recorded in LP (×2) mode by this VCR cannot be played back on VHS video decks with SP mode only.
- Noise may appear in the image when tapes recorded in LP mode by this VCR are played back on other VHS video decks with LP mode.

Recording stereo and bilingual programmes

The recorder automatically receives and records stereo and bilingual programmes based on the NICAM system.

You can switch between main and sub sounds while playing a tape (page 75).

NICAM system

When a stereo or bilingual NICAM based programme is received, “STEREO” and “NICAM” appear in the front panel display. To record a NICAM programme, be sure to set “Manual Set” – “Tuner Audio” to “NICAM” (default) in the “Tuner Preset” setup (page 98). If the sound is not clear when listening to NICAM broadcasts, select “Standard.”

Hint

You can select the audio (main or sub) while recording bilingual programmes using the  (audio) button. This does not affect the recorded sound.

VCR Recording Without the Timer

VHS

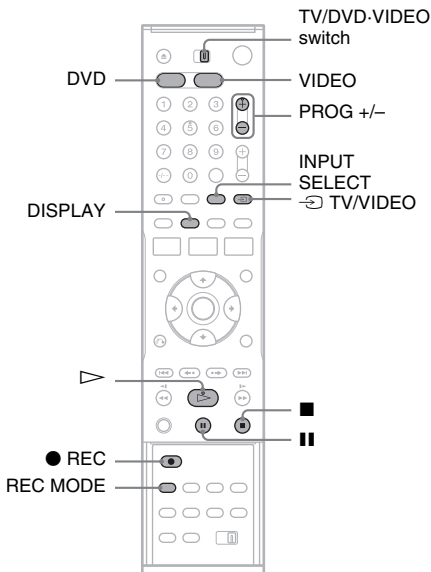

- 1 Press VIDEO to operate the VCR.
- 2 Insert a tape with its safety tab in place.

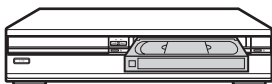

- 3 Press PROG +/- or INPUT SELECT repeatedly to select the programme position or input source you want to record.
- 4 Press REC MODE repeatedly to select the recording mode, "SP" or "LP."
For details about the recording mode, see page 76.
- 5 Press ● REC.
"REC" appears in the front panel display, and recording starts.

To stop recording

Press ■.

To pause recording

Press ■■.

To restart recording, press ■■ again.
If you pause recording for more than five minutes, recording stops automatically.

To watch another TV programme while recording

- 1 Slide the TV/DVD-VIDEO switch to TV.
- 2 Press ⇨ TV/VIDEO to set the TV to the TV input.
- 3 Select another programme position on the TV.

To watch a DVD while recording

Press DVD to operate the DVD recorder, insert a disc, and press ▷.

💡 Hints

- To select a programme position, you can use the number buttons. Enter the programme position number, and press ENTER.
- You can select a video source from the LINE jack using the INPUT SELECT button.
- Tape information displayed on the TV screen will not be recorded on the tape.
- You can turn off the TV during recording. If you are using a satellite or digital tuner, make sure to leave it on.

Notes

- You cannot change the recording mode, programme position, or input source while recording.
- If you insert a tape with its safety tab removed, the tape is ejected when you press ● REC.

Recording using the Quick Timer (One-touch Timer Recording)

You can set the recorder to record in 30-minute increments.

- 1 Press VIDEO to operate the VCR.
- 2 Press ● REC repeatedly to set the duration.

Each press advances the time in 30 minute up to six hours.

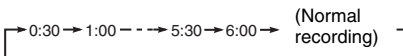

“⊖” and “OTR” light up, and the remaining recording time appears in the front panel display.

When the counter reaches “0:00,” the recorder stops recording and turns off.

Notes

- The remaining tape length may not be indicated accurately for short tapes such as E-20 or E-30, or tapes recorded in EP mode.
- After DISPLAY is pressed, it may take one minute for the remaining tape length to appear.

To cancel the Quick Timer

Press ● REC repeatedly until the counter appears in the front panel display. The recorder returns to normal recording mode.

To stop recording

Press ■ twice.

Checking the remaining tape length

You can check the recording information, such as remaining tape length or recording mode, etc.

Press DISPLAY while recording.

The information display appears.

Press the button repeatedly to change the display (page 74).

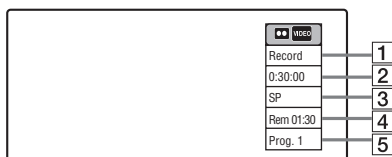

- 1 Recording status
- 2 Time counter
- 3 Recording mode
- 4 Remaining tape length
- 5 Current programme position

To check the remaining tape length, set “VCR Function” – “Tape Length” in the “Features” setup correctly (page 105).

Hint

You can view the information also in the front panel display. Press TIME/TEXT repeatedly to change the display. Note that TIME/TEXT does not work during One-touch Timer Recording.

VCR Timer Recording (Standard/VIDEO Plus+)

VHS

You can set the timer for a total of 12 programmes together with DVD and VCR timer recording, up to one month in advance.

There are two methods to set the timer: the standard method and VIDEO Plus+ method.

- Standard: Set the date, time, and programme position of the programme manually.
- VIDEO Plus+: Enter the PlusCode number designated for each TV programme (page 81).

Note

The recorder must be in standby mode for the timer recording to be made.

Setting the timer manually (Standard)

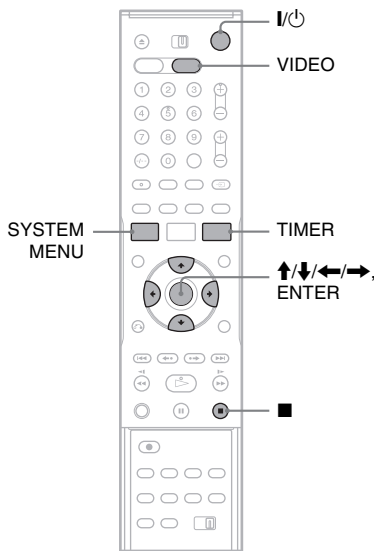

1 Press VIDEO to operate the VCR.

2 Insert a tape with its safety tab in place.

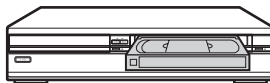

3 Press TIMER.

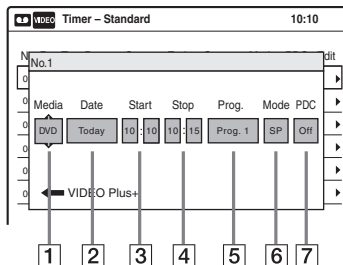

- If the Timer programming (VIDEO Plus+) menu appears, press ← to switch the display to "Standard."

4 Select an item using ←/→ and adjust using ↑/↓.

1 "Media": Select "VCR."

2 "Date": Sets the date using ↑.

To record the same programme every day or the same day every week, press ↓.

The item changes as follows:

Today ↔ Sun~Sat (Sunday to Saturday)

↔ Mon~Sat (Monday to Saturday) ↔

Mon~Fri (Monday to Friday) ↔ Sun

(every Sunday) ↔ Mon (every Monday)

↔ ... ↔ Sat (every Saturday) ↔

1 month later ↔ ... ↔ Today

3 "Start": Sets the start time.

4 "Stop": Sets the stop time.

5 "Prog.": Selects the programme position or input source.

6 "Mode": Selects the recording mode; "SP" or "LP." To use the Rec Mode Adjust function (page 80), select "AUTO."

7 "PDC": Sets the PDC function. See "About the PDC function" (page 80).

- If you make a mistake, select the item and change the setting.

5 Press ENTER.

The Timer List menu (page 84) appears. If timer settings overlap, a message appears. To change or cancel a timer recording, select “Edit” from the Timer List (page 84).

6 Press SYSTEM MENU to turn off the menu.

7 Press I/⏻ (on/standby) to turn off the recorder

The ⊖ indicator lights up in the front panel display, and the recorder is ready to start recording.

If the ⊖ indicator flashes in the front panel display, check that a tape with its safety tab in place is inserted.

To stop recording

Press ■ twice.

If timer settings overlap

The programme that starts first has priority and the second programme starts recording only after the first programme has finished. If the programmes start at the same time, the programme listed first in the menu has priority. If the end time of one setting and the start time of another timer setting is the same, the beginning of the programme that starts later will be cut.

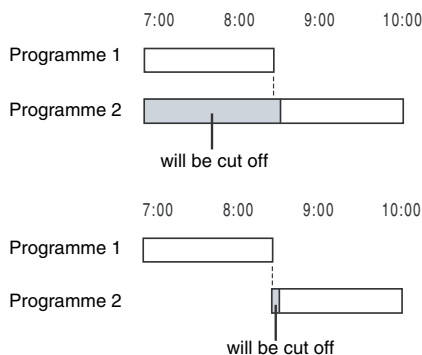

To change or cancel timer recording

See “Changing or Cancelling VCR Timer Settings (Timer List)” on page 84.

To use the Rec Mode Adjust function

If the remaining tape length is too short for the current recording, the VCR automatically changes the recording mode from SP to LP.

When setting the timer, select “AUTO” in “Mode,” and check that the “Tape Length” setting is correct for the inserted tape (“VCR Function” -

“Tape Length” in the “Features” setup (page 105)).

Note that some noise will appear on the image when the recording mode is changed. If you want to keep the recording mode, select “SP” or “LP” for “Mode.”

About the PDC function

PDC signals are transmitted with TV programmes in some broadcast systems. These signals ensure that timer recordings are made regardless of any broadcast delays, early starts, or broadcast interruptions.

◆To use the PDC function

Set “PDC” to “On” in step 4 above.

The recorder starts scanning the channel before the timer recording starts.

💡 Hints

- You can use the recorder after setting the timer. Just press I/⏻ to turn on the recorder. Turn off the recorder to return it to recording standby before the timer recording starts.
- When the start time and the programme position or input source to be recorded are the same but the “Media” setting differs, the programme is recorded to both the DVD disc and the VHS tape.
- You can also turn on the timer programming menu from the System Menu. Press SYSTEM MENU to select “Timer,” and select “Timer-Standard.”

Notes

- To record a satellite programme, turn on the satellite tuner and select the satellite programme you want to record. Leave the satellite tuner turned on until the recorder finishes recording. If you connect equipment with a timer function, you can use the Synchro Rec function (page 82).
- Even when correctly set, the programme may not be recorded if another recording is underway, or other prioritized timer setting overlaps.
- You cannot record on a tape with its safety tab removed.
- Before the timer recording starts, “TIMER REC” flashes in the front panel display.
- The recorder automatically turns off when a timer recording finishes.
- The beginning of some recordings may not be made when using the PDC function.

Recording TV programmes using the VIDEO Plus+ system

The VIDEO Plus+ system is a feature that simplifies setting the timer. Just enter the PlusCode number listed in the TV programme guide. The date, time, and programme position of that programme are set automatically. Check that the channels are correctly set in the “Tuner Preset” setup (page 98).

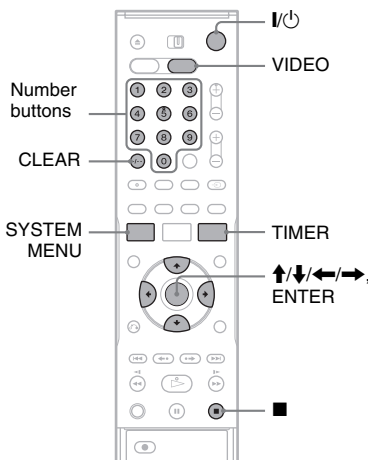

- 1 Press VIDEO to operate the VCR.
- 2 Insert a tape with its safety tab in place.
- 3 Press TIMER.

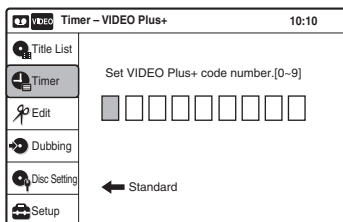

- If the Timer programming (Standard) menu appears, press ← to switch the display to “VIDEO Plus+.”

- 4 Press the number buttons to enter the PlusCode number.
 - If you make a mistake, press CLEAR and re-enter the correct number.
- 5 Press ENTER.

The date, start and stop times, programme position, recording mode, PDC setting (page 80), etc. appear.

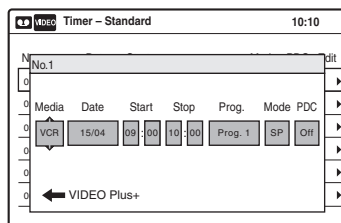

- If you want to change the setting, press ←/→ to select the item and press ↑/↓ to change the setting.

To re-enter the PlusCode number, press CLEAR.

6 Select “VCR” for “Media,” and press ENTER.

The Timer List menu (page 84) appears. If timer settings overlap, the message appears. To change or cancel a timer recording, select “Edit” from the Timer List (page 84).

7 Press SYSTEM MENU to turn off the menu.

8 Press I/Power (on/standby) to turn off the recorder.

The ⊖ indicator lights up in the front panel display, and the recorder is ready to start recording.

If the ⊖ indicator flashes in the front panel display, check that a tape with its safety tab in place is inserted.

To stop recording

Press ■ twice.

If timer settings overlap

See page 80.

To change or cancel timer recording

See “Changing or Cancelling VCR Timer Settings (Timer List)” on page 84.

Hints

- You can use the recorder after setting the timer. Just press  to turn on the recorder. Turn off the recorder to return it to recording standby before the timer recording starts.
- When the start time and the programme position or input source to be recorded are the same but the "Media" setting differs, the programme is recorded to both the DVD disc and the VHS tape.
- You can also turn on the timer programming menu from the System Menu. Press SYSTEM MENU to select "Timer," and select "Timer - VIDEO Plus+."

Notes

- To record a satellite programme, turn on the satellite tuner and select the satellite programme you want to record. Leave the satellite tuner turned on until the recorder finishes recording. If you connect equipment with a timer function, you can use the Synchro Rec function.
- Even when correctly set, the programme may not be recorded if another recording is underway, or other prioritized timer setting overlaps.
- Before the timer recording starts, "TIMER REC" flashes in the front panel display.
- The recorder automatically turns off when a timer recording finishes.

Recording From Connected Equipment With a Timer (Synchro Rec)

VHS

You can set the recorder to automatically record programmes from connected equipment that has a timer function (such as a satellite tuner). Connect the equipment to the LINE 3/DECODER jack on the rear of the recorder (page 28).

When the connected equipment turns on, the recorder starts recording a programme from the LINE 3/DECODER jack.

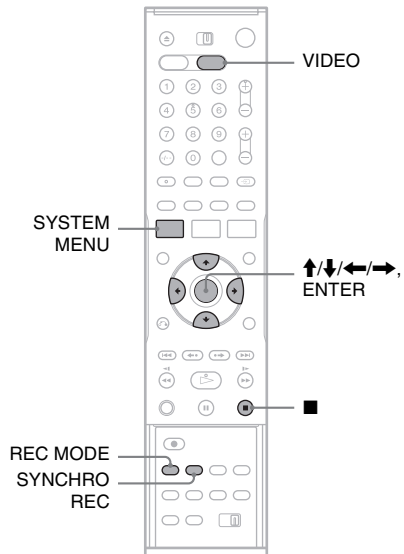

- 1** Press VIDEO to operate the VCR.
- 2** Insert a tape with its safety tab in place.
- 3** Press REC MODE repeatedly to select the recording mode, "SP" or "LP."
- 4** Press SYSTEM MENU while the recorder is in stop mode.
- 5** Select "Setup," and press ENTER.
- 6** Select "Features," and press ENTER.
The "Features" setup appears.
- 7** Select "Synchro Recording," and press ENTER.

- 8** Select “to Video,” and press ENTER.
- 9** Press SYSTEM MENU to turn off the menu.
- 10** Set the timer on the connected equipment to the time of the programme you want to record, and turn it off.
- 11** Press SYNCHRO REC.

The SYNCHRO REC indicator lights up on the front panel and the recorder stands by for Synchro-Rec.

The recorder starts recording when a signal is received from the connected equipment.

When the connected equipment turns off, the recording stops and the recorder turns off.

To stop recording

Press ■ twice.

To cancel Synchro Rec function

Press SYNCHRO REC before recording starts. The SYNCHRO REC indicator on the recorder turns off.

If you press SYNCHRO REC during Synchro-Rec, the recording stops, the SYNCHRO REC indicator turns off, and the recorder turns off.

If the timer settings of a Synchro-Rec and another timer recording overlap

Regardless of whether or not the programme is a Synchro-Rec programme, the programme that starts first has priority. The recorder starts recording the second programme about ten seconds after the first programme has finished. If the end time of one setting and the start time of another timer setting is the same, the beginning of the programme that starts later will be cut.

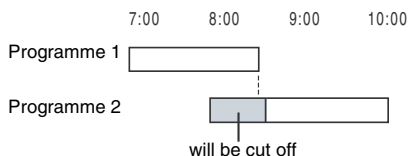

Notes

- The recorder starts recording only after detecting the video signal from the connected equipment. The beginning of the programme may not be recorded regardless of whether or not the recorder's power is on or off.
- To use the connected equipment during Synchro-Rec standby, cancel the standby mode by pressing SYNCHRO REC. To return to standby mode again, be sure to turn off the equipment and press SYNCHRO REC, before Synchro-Rec starts.
- The Synchro-Rec function does not work with some tuners. For details, see the tuner's operating instructions.
- During Synchro-Rec standby, the Auto Clock Set function (page 100) does not work.
- After a recording has finished, the recorder enters the Synchro-Rec standby mode until the SYNCHRO REC indicator turns off.
- You cannot record on a tape with its safety tab removed.
- If Synchro-Rec starts with the recorder turned on, the recorder will turn off when the recording ends.

Changing or Cancelling VCR Timer Settings (Timer List)

VHS

You can change or cancel timer settings using the Timer List menu.

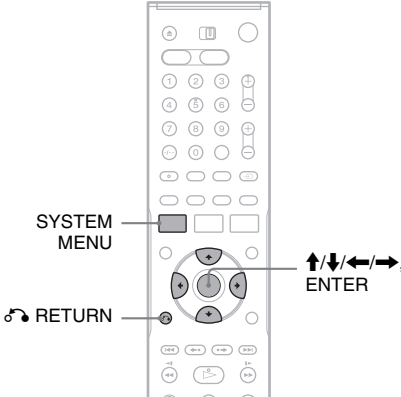

- 1** Press **SYSTEM MENU**.
The System Menu appears.
- 2** Select **"Timer,"** and press **ENTER**.
- 3** Select **"Timer List,"** and press **ENTER**.

No	Media	Date	Start	Stop	Prog.	Mode	PDC	Edit
01	VCR	15/04	09:00	10:00	Prog. 1	SP	Off	▶
02	VCR	30/04	09:15	09:45	Prog. 2	SP	Off	▶
03	---	--/--	--:--	--:--	----	---	---	▶
04	---	--/--	--:--	--:--	----	---	---	▶
05	---	--/--	--:--	--:--	----	---	---	▶
06	---	--/--	--:--	--:--	----	---	---	▶

Timer information displays the recording date, time, recording mode, etc.
If there are more than six timer settings, press **↓** to display the next page.

- 4** Select the timer setting you want to change or cancel, and press **ENTER**.

The sub-menu appears.

No	Media	Date	Start	Stop	Prog.	Mode	PDC	Edit
01	VCR	15/04	09:00	10:00	Prog. 1	SP	Off	▶
02	VCR	30/04	09:15	09:45	Prog. 2	SP	Off	▶
03	---	--/--	--:--	--:--	----	---	---	▶
04	---	--/--	--:--	--:--	----	---	---	▶
05	---	--/--	--:--	--:--	----	---	---	▶
06	---	--/--	--:--	--:--	----	---	---	▶

- 5** Select one of the options, and press **ENTER**.

“Edit”: Changes the timer setting.
Select an item using **←/→** and adjust using **↑/↓**. Press **ENTER**.

No.	Media	Date	Start	Stop	Prog.	Mode	PDC	Edit
01	VCR	15/04	09:00	10:00	Prog. 1	SP	Off	▶

← VIDEO Plus+

“Del”: Erases the timer setting.
Select “OK” and press **ENTER** when asked for confirmation.

No.	Media	Date	Start	Stop	Prog.	Mode	PDC	Edit
01	VCR	15/04	09:00	10:00	Prog. 1	SP	Off	▶

Do you want to erase 'No.1'?

OK Cancel

- 6** Press **SYSTEM MENU** to turn off the Timer List.

If any settings remain, turn off the recorder to return it to recording standby.

To return to the previous display

Press **RETURN**.

Notes

- Even when correctly set, the programme may not be recorded if another recording is underway, or other prioritized timer setting overlaps. For priority, see page 80.

- You cannot change the timer settings for a recording currently underway.
- The Timer List displays both the DVD recorder and VCR timer settings.

Recording From Connected Equipment Without a Timer

VHS

You can record from a connected VCR or similar device. For connection details, see “Connecting Another VCR or Similar Device” on page 26.

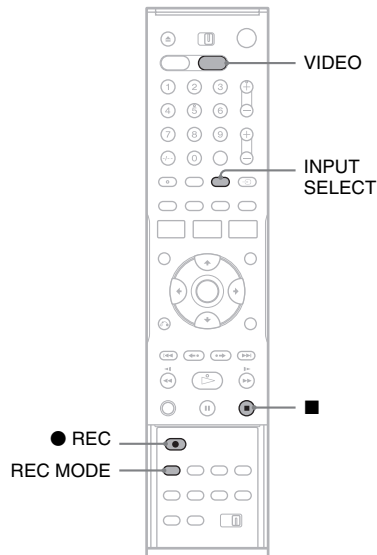

- 1** Press VIDEO to operate the VCR.
- 2** Insert a tape with its safety tab in place.
- 3** Press INPUT SELECT repeatedly to select an input source according to the connection you made.

The front panel display changes as follows:

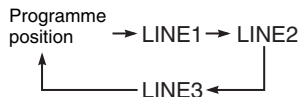

- 4** Press REC MODE repeatedly to select the recording mode, “SP” or “LP.”
- 5** Insert the source tape into the connected equipment and set to playback pause.

6 Press ● REC on this recorder and the pause or play button on the connected equipment at the same time.

Recording starts.

To stop recording, press ■ on this recorder.

Notes

- A video game image may not be recorded clearly.
- You cannot record on a tape with its safety tab removed.
- During recording or recording pause, you cannot change the recording mode.
- You cannot change the recording mode, programme position, or input source while recording.

Dubbing From a VHS Tape to a DVD

+RW **-RWVR** **-RWVideo** **+R** **-R** **VHS**

You can easily record (dub) a VHS tape to a disc. Before dubbing, make the necessary audio settings on the VCR.

◆How titles and chapters are created

The recorder takes each recording on the VHS tape and automatically divides them into titles as they are dubbed to a disc. These titles are then further divided into chapters at either 5 or 15-minute intervals, according to the “DVD Auto Chapter” setting in the “Features” setup (page 105).

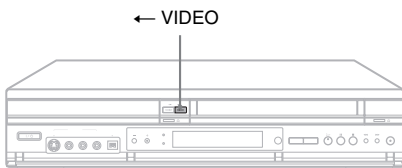
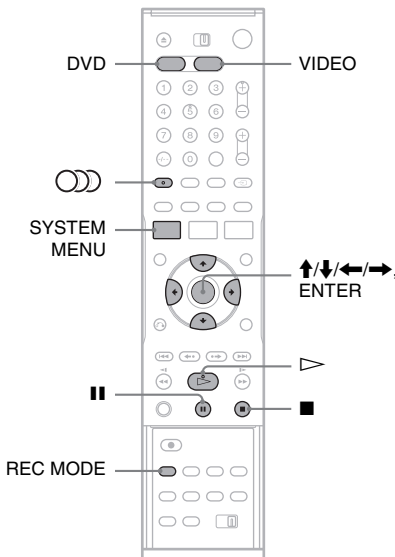

1 Press DVD and insert a recordable disc.

To select the recording mode, press REC MODE repeatedly (see page 47).

2 Insert a source VHS tape.

3 Press VIDEO to operate the VCR.

4 Start playing the VHS tape, and then press ■ (stop) or II (pause) at the point where you want to start dubbing.

To select VCR sound, press ○○○ (audio) during playback (see page 75).

5 Press ← VIDEO on the recorder.

Dubbing starts.

To stop dubbing

Press ■.

Note that it may take a few seconds for the recorder to stop dubbing.

To play discs recorded with this recorder on other DVD equipment

Finalize the disc (see page 91).

To dub using the on-screen menu

- After step 4 above, press SYSTEM MENU.
- Select “Dubbing” from the System Menu, and press ENTER.
- Select “Simple Dubbing,” and press ENTER.

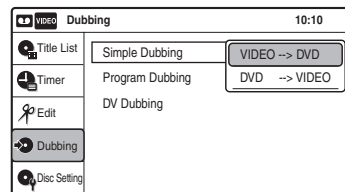

- Select “VIDEO → DVD,” and press ENTER. The display asks for confirmation.
- Select “Yes,” and press ENTER. Dubbing starts.

💡 Hints

- A black (no signal) screen at the end of the dubbed disc is not a malfunction. This screen is recorded if a time discrepancy exists between the disc and tape when the recording is stopped.
- When dubbing a VHS tape to a DVD, the VHS tape counter value may differ slightly from the DVD recording time.
- VCR playback sound is output during dubbing.

Notes

- Dubbing cannot be made when:
 - using a non-recordable DVD.
 - using VHS software with copy guard functions.
- Dubbing stops when:
 - the VHS tape reaches the end and stops.
 - the VHS video deck or the DVD deck is stopped.
 - the disc remaining time runs out.
- The System Menu, TOOLS menu, and information display are not displayed during dubbing.
- Copyrights
 - Recordings made from VHS tapes and other copyrighted material are solely for individual enjoyment, and other unauthorized use is prohibited under copyright law.
 - Unauthorized editing of copyrighted material is prohibited under copyright law.

Dubbing From a DVD to a VHS Tape



You can record (dub) a DVD title to a VHS tape. Note that when you record copy-protected software to a tape, picture may appear disrupted when you play back the tape.

You can also select titles or scenes and dub them all at once. See “Dubbing selected titles and scenes (Programme Dubbing)” on page 89.

Before dubbing, make the necessary audio settings on the DVD recorder.

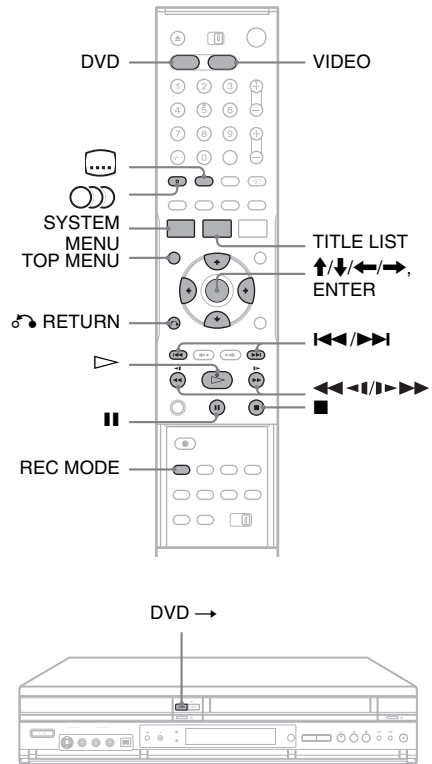

1 Press VIDEO and insert a VHS tape with its safety tab in place.

To select the recording mode, SP or LP, press REC MODE repeatedly.

- 2** Insert a source disc.
- 3** Press **DVD** to operate the DVD recorder.
- 4** Press **TOP MENU** or **TITLE LIST** to select a title.
- 5** Start playing the DVD, and then press **■** (stop) or **||** (pause) at the point where you want to start dubbing.
To select DVD sound, language, or subtitle, press **⓪⓪** (audio) or **⋮** (subtitle) during playback (see page 35).
- 6** Press **DVD →** on the recorder.
Dubbing starts.

To stop dubbing

Press **■**.

Note that it may take a few seconds for the recorder to stop dubbing.

To dub using the on-screen menu

- 1** After step 5 above, press **SYSTEM MENU**.
- 2** Select “Dubbing” from the System Menu, and press **ENTER**.
- 3** Select “Simple Dubbing,” and press **ENTER**.

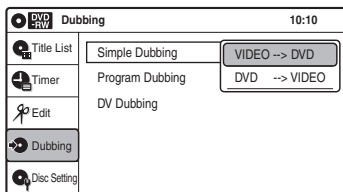

- 4** Select “DVD → VIDEO,” and press **ENTER**.
The display asks for confirmation.
- 5** Select “Yes,” and press **ENTER**.
Dubbing starts.
If the disc’s menu appears when DVD playback finishes, press **■** to stop dubbing. Otherwise the disc’s menu is recorded until the tape reaches its end.

💡 Hints

- The brightness of the playback picture may differ from normal DVD playback picture.
- The DVD playback time may differ slightly from the VHS tape counter value.
- The sound being played back (main, sub, etc.) is the dubbed sound.

Notes

- Dubbing cannot be made when “Progressive” is set to “On” in the “Video” setup (page 102).
- Dubbing stops when:
 - the DVD is played back to the end and stops.
 - the DVD deck or the VHS video deck is stopped.
 - the tape remaining time runs out.
- The System Menu, **TOOLS** menu, and information display are not displayed during dubbing.
- Copyrights
 - Recordings made from discs and other copyrighted material are solely for individual enjoyment, and other unauthorized use is prohibited under copyright law.
 - Unauthorized editing of copyrighted material is prohibited under copyright law.

Dubbing selected titles and scenes (Programme Dubbing)

You can select titles or scenes from a DVD, and dub the contents to a VHS tape all at once.

- 1** Press **VIDEO** and insert a VHS tape with its safety tab in place.
To select the recording mode, **SP** or **LP**, press **REC MODE** repeatedly.
- 2** Press **DVD** and insert a source disc.
To select DVD sound, language, or subtitle, press **⓪⓪** (audio) or **⋮** (subtitle) during playback (see page 35).
- 3** Press **SYSTEM MENU**.
The System Menu appears.
- 4** Select “Dubbing,” and press **ENTER**.

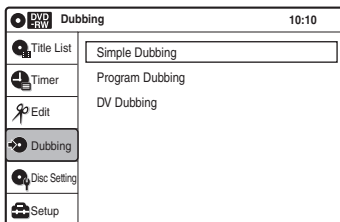

- 5** Select “Program Dubbing,” and press **ENTER**.

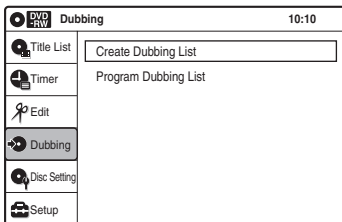

6 Select “Create Dubbing List,” and press ENTER.

If you have performed Programme Dubbing before, the display asks for confirmation. To continue, select “Yes” and press ENTER. The display for selecting titles appears.

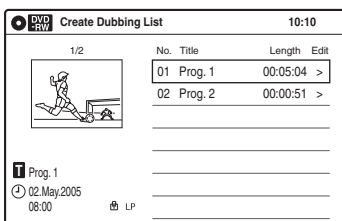

7 Select the title you want to dub, and press ENTER.

The sub-menu appears. To dub the entire title, select “Title Dubbing” and press ENTER. The Program Dubbing List appears with the selected title. Go to step 13. To select a scene to dub, go to step 8.

8 Select “Scene Dubbing,” and press ENTER.

The display for setting a scene appears. “Start” is selected.

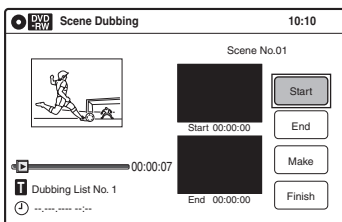

9 Press ENTER at the start point.

You can use \triangleright , \lll , $\lll|$, $|$, \ggg , $\ggg|$, $|$, and \lll to find the point. “End” is selected.

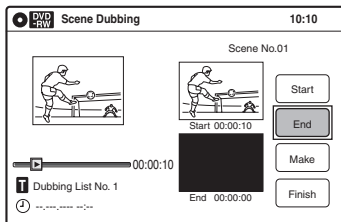

10 Press ENTER at the end point.

“Make” is selected.

To reset the start or end point, select “Start” or “End” and repeat from step 9 or 10.

11 Press ENTER.

To continue, repeat from step 9.

12 Select “Finish,” and press ENTER.

The Program Dubbing List appears with the selected scene.

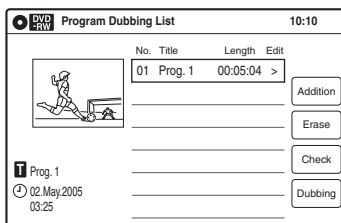

13 Select an option and press ENTER, if necessary.

“Addition”: Adds other titles or scenes. Repeat from step 7.

“Erase”: Cancels the selected title or scene. When asked for confirmation, select “OK” and press ENTER.

“Check”: Plays back the selected title or scene. When playback finishes or when you press \curvearrowright RETURN, the display returns to “Program Dubbing List.”

To cancel dubbing, press \curvearrowright RETURN.

14 Select “Dubbing,” and press ENTER.

Dubbing starts.

To stop dubbing

Press \blacksquare .

Note that it may take a few seconds for the recorder to stop dubbing.

Hints

- The brightness of the playback video may differ from that during normal DVD playback.
- The DVD playback time may differ slightly from the VHS tape counter value.
- The sound being played back (main, sub, etc.) is the dubbed sound.

Notes

- Dubbing cannot be made when “Progressive” is set to “On” in the “Video” setup.
- Dubbing stops when:
 - the DVD is played back to the end and stops.
 - the DVD deck or the VHS video deck is stopped.
 - the tape remaining time runs out.
- The System Menu, TOOLS menu, and information display are not displayed during dubbing.
- Copyrights
 - Recordings made from discs and other copyrighted material are solely for individual enjoyment, and other unauthorized use is prohibited under copyright law.
 - Unauthorized editing of copyrighted material is prohibited under copyright law.
- Once you eject the disc, the Program Dubbing List is erased.

Finalizing a Disc (Preparing a Disc for Playback on Other Equipment)

+RW **-RWVR** **-RW_{Video}** **+R** **-R**

Finalizing is necessary in order to play discs recorded with this recorder on other DVD equipment.

When you finalize a DVD+RW/DVD-RW (Video mode)/DVD+R/DVD-R, a DVD menu will be automatically created, which can be displayed on other DVD equipment.

Before finalizing, check the differences between the disc types in the table below.

Differences between the disc types

+RW Discs are automatically finalized when removed from the recorder. If you want to record on it again, reformat the disc (page 69). Note however, that reformatting a disc erases all its contents.

-RWVR Finalizing is unnecessary when playing a disc on VR format compatible equipment. Even if your other DVD equipment is VR format compatible, you may need to finalize the disc, especially if the recording time is short. After finalizing, you cannot edit or record on the disc. If you want to edit or record on it again, unfinalize or reformat the disc (page 69). Note however, that reformatting a disc erases all its contents.

-RW_{Video} Finalizing is necessary in order to play on equipment other than this recorder. After finalizing, you cannot edit or record on the disc. If you want to edit or record on it again, unfinalize or reformat the disc (page 69). Note however, that reformatting a disc erases all its contents.

+R Finalizing is necessary in order to play on equipment other than this recorder.
-R After finalizing, you cannot further edit or record on the disc.

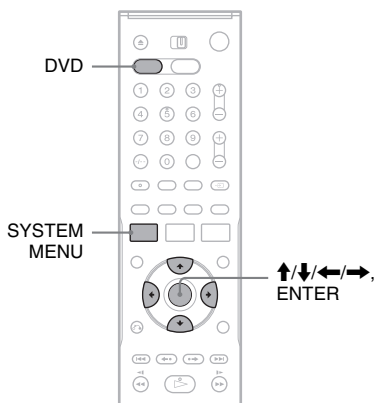

- 1** Press DVD to operate the DVD recorder.
- 2** Insert a disc.
- 3** Press SYSTEM MENU while the recorder is in stop mode.
The System Menu appears.
- 4** Select “Disc Setting,” and press ENTER.
The “Disc Setting” display appears.

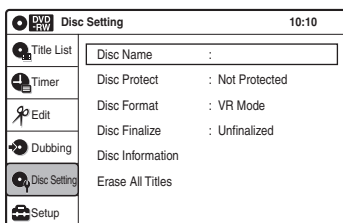

- 5** Select “Disc Finalize,” and press ENTER.
The display asks for confirmation.

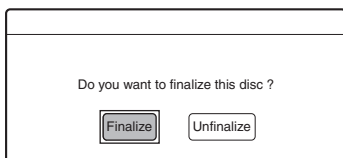

- 6** Select “Finalize,” and press ENTER.
The display for confirmation appears again.

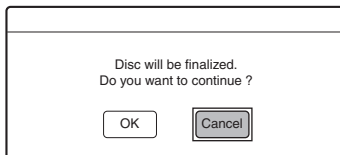

- 7** Select “OK,” and press ENTER.
The recorder starts finalizing the disc.

To turn off the display

Press SYSTEM MENU.

To unfinalize a DVD-RW (VR mode)

If you cannot record or edit on a DVD-RW (VR mode) that has been finalized, unfinalize the disc by selecting “Unfinalize” in step 6 above.

Hints

- You can check whether the disc has been finalized or not. If you cannot select “Finalize” in step 6 above, the disc has already been finalized.
- To check the disc information, select “Disc Information” in the “Disc Setting” display and press ENTER. See page 69 for details.

Notes

- Depending on the condition of the disc, the recording, or the DVD equipment, discs may not play even if the discs are finalized.
- The recorder may not be able to finalize a disc if it was recorded on another recorder.

Before DV Dubbing

This section explains dubbing with a digital video camera via the DV IN jack on the front panel. If you want to dub by way of the LINE 2 IN jacks, see “Recording From Connected Equipment Without a Timer” on page 57.

To record from the DV IN jack

The DV IN jack on this recorder conforms to the i.LINK standard. You can connect any other equipment that has an i.LINK (DV) jack, and record digital signals.

Follow the instructions in “Connecting a Digital Video Camera to the DV IN Jack” and then move on to the section on dubbing.

For more information about i.LINK, see “About i.LINK” on page 117.

Hint

If you plan to do additional editing on a disc after the initial dub, use the DV IN jack and record on a DVD-RW (VR mode).

Connecting a Digital Video Camera to the DV IN Jack

You can connect a digital video camera to the DV IN jack on the recorder to record or edit from a DV format tape.

Operation is straightforward because the DVD recorder will fast forward and rewind the tape for you – you do not need to operate your digital video camera. Do the following to start using the “DV Edit” functions of this recorder.

See the instruction manual supplied with the digital video camera as well before connecting.

Notes

- The DV IN jack is for input only. It will not output signals.
- You cannot use the DV IN jack when:
 - your digital video camera does not work with this recorder. Connect the camera to the LINE 2 IN jacks and follow the instructions of “Recording From Connected Equipment Without a Timer” on page 57.
 - the input signal is not in DVC-SD format. Do not connect a MICRO MV format digital video camera even if it has an i.LINK jack.
 - the images on the tape contain copy protection signals, which limit recording.

Hookups

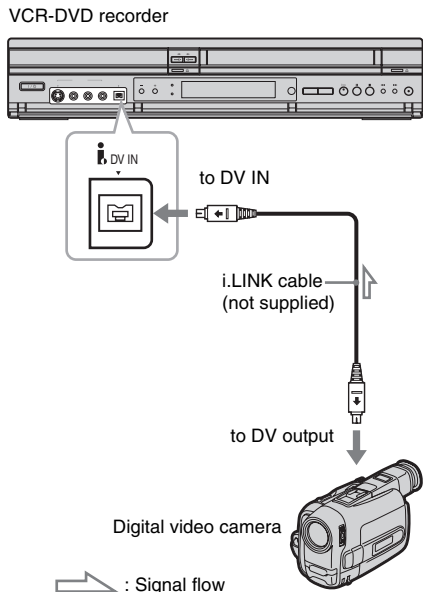

Dubbing From a DV Format Tape to a DVD

+RW -RWVR -RW_{video} +R -R

You can record a DV format tape onto a disc. The recorder controls the digital video camera. You can fast forward, rewind, play in slow motion, and stop the tape to select the scenes using the on-screen menu.

To simply dub the entire contents of a DV format tape (One Touch Dubbing), see page 96.

◆How titles and chapters are created

The dubbed contents on the disc become one title, and the title is then divided into chapters at either 5 or 15-minute intervals, according to the “DVD Auto Chapter” setting in the “Features” setup (page 105).

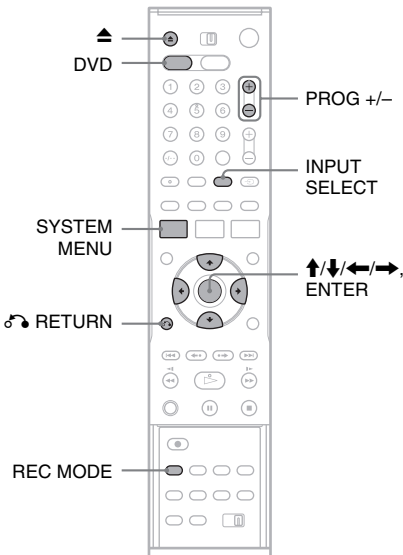

1 Press DVD to operate the DVD recorder.

2 Press \blacktriangle (open/close), and place a recordable disc on the disc tray.



Recording side facing down

3 Press \blacktriangle to close the disc tray.

Wait until “LOAD” disappears from the front panel display.

Unused DVD-RWs are formatted in VR mode automatically. To format in Video mode, see page 105.

4 Insert the source DV format tape into your digital video camera.

For the recorder to record or edit, your digital video camera must be set to video playback mode.

5 Press INPUT SELECT repeatedly to select “DV.”

6 Press REC MODE repeatedly to select the recording mode.

For details about the recording mode, see page 47.

7 Press SYSTEM MENU while the recorder is in stop mode.

The System Menu appears.

8 Select “Setup,” and press ENTER.

The “Setup” display appears.

9 Select “Audio,” and press ENTER.

DVD Audio		10:10
Title List	Digital Out	: On
Timer	Downmix	: Dolby Surround
Edit	Audio DRC	: Standard
	Scan Audio	: On
Dubbing	DV Audio Input	: Stereo 1
	Line Audio Input	: Stereo
Disc Setting		
Setup		

10 Select “DV Audio Input,” and press ENTER.

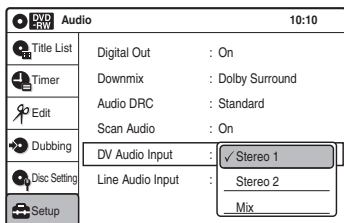

“Stereo 1”: Records original sound only. Normally select this when dubbing a DV format tape.

“Stereo 2”: Records additional audio only. “Mix”: Records original and additional sounds.

Select “Stereo 2” or “Mix” if you have added a second audio channel when recording with your digital video camera.

For the details, see page 104.

11 Select an option, and press ENTER.

12 Press RETURN twice.

13 Select “Dubbing,” and press ENTER.

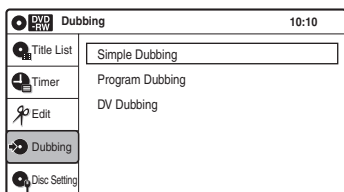

14 Select “DV Dubbing,” and press ENTER.

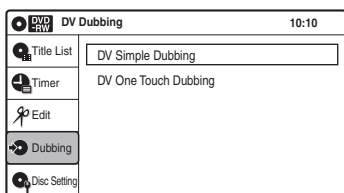











15 Select “DV Simple Dubbing,” and press ENTER.

The following display appears.



If “DV” or “DV Camera Mode” is displayed instead of “DV Tape Mode,” check that the digital video camera is correctly connected and its power turned on, and that its mode is set for dubbing.

16 Find the dubbing start point on the tape, and stop or pause playback.

Press /  to select , , , , , or  on the TV screen and press ENTER to find the point, and stop or pause with  or .

17 Press to select on the TV screen, and press ENTER.

Dubbing starts.

To stop recording

Select  on the TV screen, and press ENTER. Note that it may take a few seconds for the recorder to stop recording.

To turn off the display for DV dubbing

Press INPUT SELECT or PROG +/-.

Hint

If “DV Camera Mode” appears on the TV screen, you can use  on the TV screen to record the camera image directly on the recorder.

Notes

- If you want to play the disc on other DVD equipment, finalize the disc (page 91).
- You cannot connect more than one piece of digital video equipment to the recorder.
- You cannot record the date, time, or contents of a DV format tape onto the disc.
- If you record from a DV format tape with a soundtrack that is recorded in multiple sampling frequencies (48 kHz, 44.1 kHz, or 32 kHz), no sound, or an unnatural sound will be output when playing back the sampling frequency switch point on the disc.
- The recorded picture may be momentarily affected if the picture size of the source image changes, or if there is nothing recorded on the tape.
- Noise may occur when you switch the audio sampling mode (48 kHz/16 bits → 32 kHz/12 bits).

Dubbing an entire DV format tape to a DVD (One Touch Dubbing)

+RW -RWVR -RW_{video} +R -R

You can record the entire contents of a DV format tape onto a disc with a single press of the ONE TOUCH DUBBING button. The recorder controls the digital video camera for the whole process, and completes the recording.

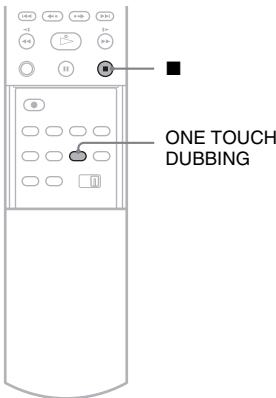

Follow steps 1 to 11 of “Dubbing From a DV Format Tape to a DVD” (page 94), and press ONE TOUCH DUBBING on the remote.

The recorder rewinds the tape in the digital video camera and then starts recording the tape contents from the beginning.

When playback of the tape stops, One Touch Dubbing ends automatically.

To stop recording

Press ■.

Note that it may take a few seconds for the recorder to stop recording.

Hint

You can also perform One Touch Dubbing using the System Menu. Select “Dubbing,” and select “DV One Touch Dubbing.” Follow the instructions appearing on the TV screen.

Settings and Adjustments

Using the Setup Displays

By using the setup displays, you can make various adjustments to items such as picture and sound, as well as select a language for the subtitles. The setup displays are used in the following way.

Note

Playback settings stored on the disc take priority over the setup display settings, and not all of the functions described may work.

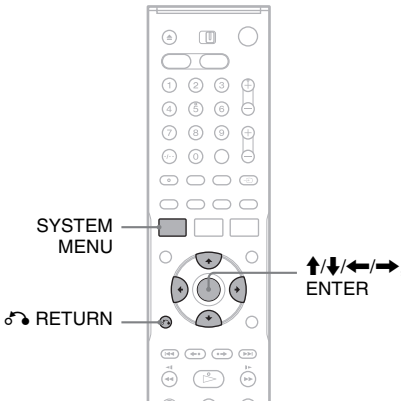

1 Press SYSTEM MENU while the recorder is in stop mode.

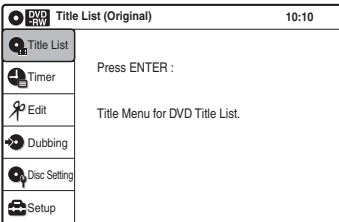

2 Select "Setup," and press ENTER.

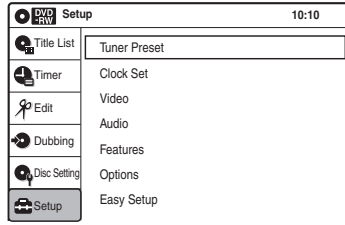

3 Select "Tuner Preset," "Clock Set," "Video," "Audio," "Features," "Options," or "Easy Setup," and press ENTER.

The selected setup display appears. Example: "Video" setup

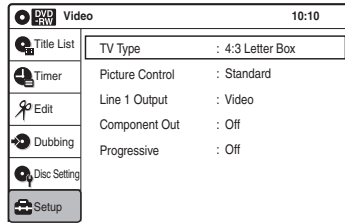

4 Select the item you want to set up, and press ENTER.

Available options for the item appear. Example: "TV Type"

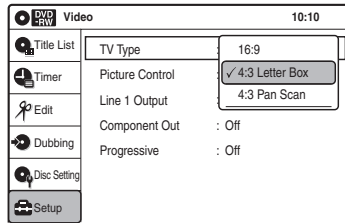

Some items display a dialogue box that requires additional settings.
 Example: When “Parental” in “Options” setup is selected.

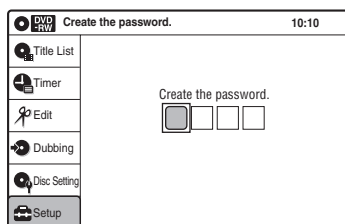

5 Select an option, and press ENTER.

The currently selected option is displayed next to the setup item.

Example: When “16:9” is set.

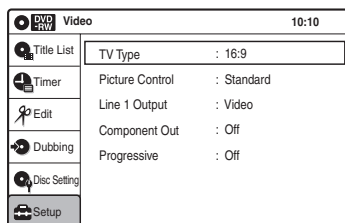

To return to the previous display

Press RETURN.

To turn off the display

Press SYSTEM MENU.

Aerial Reception Setting (Tuner Preset)

The “Tuner Preset” setup allows you to make tuner settings for the recorder.

Select “Tuner Preset” in the “Setup” display.

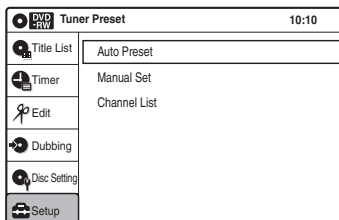

Note

You cannot preset channels for a connected satellite or digital tuner.

Auto Preset

Automatically presets the receivable channels. All receivable channels are preset in numerical sequence.

Select “Auto Preset,” and press ENTER.

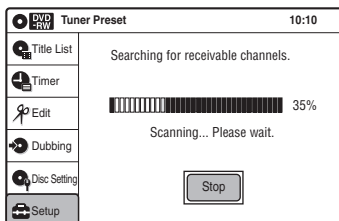

Manual Set

Presets or disables channels manually.

If some channels could not be set using the “Auto Preset” or “Easy Setup” function, you can set them manually.

- 1 Select “Manual Set,” and press ENTER. The display for manual setting appears.

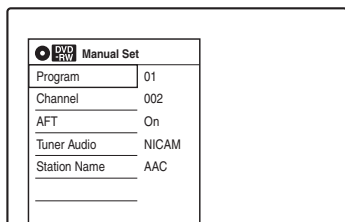

2 Select an option and press ENTER.

“Program”: Press \uparrow/\downarrow repeatedly to select the programme position (1 to 80) for the channel and press ENTER.

“Channel”: Press \uparrow/\downarrow to select the channel number (002 to 255) and press ENTER.

“AFT”: Fine tunes the channel to obtain a clearer picture. If the picture is not clear, select “Off” and press ENTER. See “To adjust pictures manually” (page 99).

“Tuner Audio”: Sets the channels for the NICAM broadcast. Normally, select “NICAM.” If the sound from the NICAM broadcast is not clear, select “Standard” and press ENTER.

“Station Name”: Changes a station name. See “To rename the station” (page 99).

◆To adjust pictures manually

Select “Off” for “AFT” in the display for manual setting. When the fine tuning bar appears, press \leftarrow/\rightarrow to obtain a clearer picture, then press ENTER.

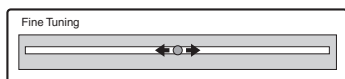

◆To rename the station

You can set up to four characters for the station name. Select “Station Name” in the display for manual setting.

Press \uparrow/\downarrow to select a character.

Each time you press \uparrow , the character changes as follows: A \rightarrow B... \rightarrow Z \rightarrow 0 \rightarrow 1... \rightarrow 9 \rightarrow - \rightarrow A

Press \rightarrow to set the next character. To correct a character, press \leftarrow and reset it. After setting all characters, press ENTER.

Channel List

You can change or disable the programme positions after setting the channels. The disabled

programme positions will be skipped when you press PROG +/-.

- 1 Select “Channel List” and press ENTER. The list of all the preset channels appears.

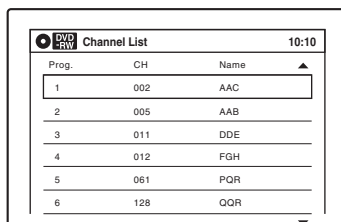

- 2 Press \uparrow/\downarrow to select the row containing the programme position you want to change or disable.

To change, press ENTER and go to step 3. To disable, press CLEAR and go to step 5.

If there are more than six programme positions, press \uparrow/\downarrow repeatedly to display the next page.

- 3 Press \uparrow/\downarrow until the selected channel row moves to the desired programme position.

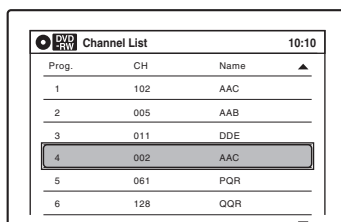

- 4 Press ENTER.

The selected channel is inserted at the new programme position.

- 5 To change or disable the programme position of another station, repeat from step 2.

Note

Be sure to correctly select the programme position you want to disable. If you disable the wrong programme position by mistake, you need to reset that channel manually.

Clock Setting (Clock Set)

The “Clock Set” setup allows you to make clock settings for the recorder.
Select “Clock Set” in the “Setup” display.

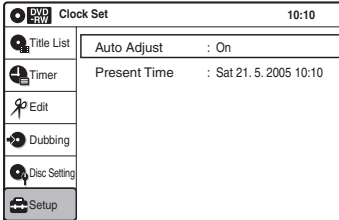

- 2 Press **↑/↓** to set the day, and press **→**.
Set the month, year, hour, and minutes, in sequence. Press **←/→** to select the item to be set, then press **↑/↓** to set the item. The day of the week is set automatically.
- 3 Press **ENTER** to start the clock.

Auto Adjust

Turns on the Auto Clock Set function when a channel in your local area broadcasts a time signal.
The Auto Clock Set function is activated whenever the recorder is turned off.

If the recorder does not receive a time signal from any station, “Auto Adjust” returns to “Off” automatically and the display for setting the clock manually appears. See “Present Time” below.

Note

The Auto Clock Set function does not work while recording.

Present Time

If the Auto Clock Set function does not set the clock correctly for your local area, set the clock manually.

- 1 Select “Present Time,” and press **ENTER**.

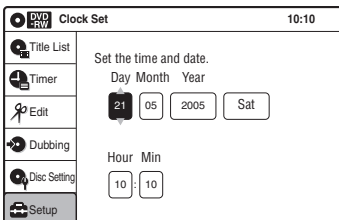

Video Settings (Video)

The “Video” setup allows you to adjust items related to the image, such as size and colour. Choose the settings according to the type of TV or tuner connected to the recorder.

Select “Video” in the “Setup” display. The default settings are underlined.

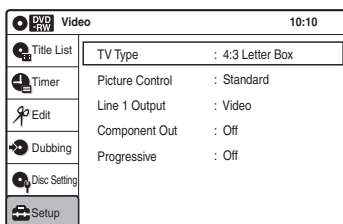

TV Type

Selects the aspect ratio of the connected TV (4:3 standard or wide).

16:9	Select this when connecting to a wide-screen TV or TV with a wide mode function.
<u>4:3 Letter Box</u>	Select this when connecting to a 4:3 screen TV. Displays a wide picture with bands on the upper and lower portions of the screen.
4:3 Pan Scan	Select this when connecting to a 4:3 screen TV. Automatically displays a wide picture on the entire screen and cuts off the portions that do not fit.

16:9



4:3 Letter Box



4:3 Pan Scan



Note

Depending on the disc, “4:3 Letter Box” may be selected automatically instead of “4:3 Pan Scan” or vice versa.

Picture Control

You can adjust the video signal from the recorder to obtain the picture quality you want. Select the setting that best suits the programme you are watching.

Dynamic 1	Produces a bold dynamic picture by increasing the picture contrast and the colour intensity.
Dynamic 2	Produces a more dynamic picture than Dynamic 1 by further increasing the picture contrast and the colour intensity.
<u>Standard</u>	Displays a standard picture (function turned off).
Cinema 1	White colours become brighter and black colours become richer, and the colour contrast is increased.
Cinema 2	Enhances details in dark areas by increasing the black level.
Personal	Adjusts “Contrast,” “Brightness,” “Colour,” and “Hue” using \uparrow/\downarrow / \leftarrow/\rightarrow .

💡 Hint

When you watch a movie, “Cinema 1” or “Cinema 2” is recommended.

Line 1 Output

Selects a method of outputting video signals for the \rightarrow LINE 1-TV jack.

<u>Video</u>	Outputs video signals
RGB	Outputs RGB signals.

Note

You cannot select “RGB” when “Component Out” below is set to “On.”

Component Out

Selects whether or not to output video signals from the COMPONENT VIDEO OUT jacks.

On	Outputs the component video signals. Select this when you want to view progressive signals.
Off	Outputs no signals.

Notes

- When you set “Line 1 Output” to “RGB,” you cannot set “Component Out” to “On.”
- When you connect the recorder to a monitor or projector via only the COMPONENT VIDEO OUT jacks, do not select “Off,” as the picture will not appear.

Progressive

If your TV accepts progressive (525p/625p) format signals, you will enjoy accurate colour reproduction and high quality image.

- 1 Select “Progressive,” and press ENTER.
- 2 Select “On,” and press ENTER.

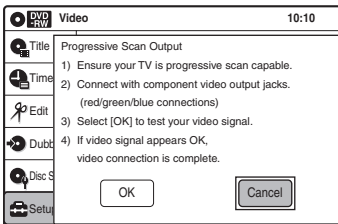

- 3 Follow the instructions appearing on the TV screen.
 - 1) Ensure your TV is progressive scan capable.
 - 2) Connect with component video output jacks (red/green/blue connections).
See “If your TV has component video input jacks” on page 16.
 - 3) Select [OK] to test your video signal.
 - 4) If video signal appears OK, video connection is complete.
- 4 Select “OK” and press ENTER.
The PROGRESSIVE indicator on the recorder lights up.
If picture is distorted, press ↶ RETURN.
Check the connection (page 16).

Hint

To cancel the “Progressive” setting, press **|| PAUSE** on the recorder continuously for five seconds or more, or select “Off” in step 2 above.

Note

If you select progressive signals when you connect the recorder to a TV that cannot accept the signal in progressive format, the image quality will deteriorate. In this case, set “Progressive” to “Off.”

Audio Settings (Audio)

The “Audio” setup allows you to adjust the sound according to the playback and connection conditions.

Select “Audio” in the “Setup” display. The default settings are underlined.

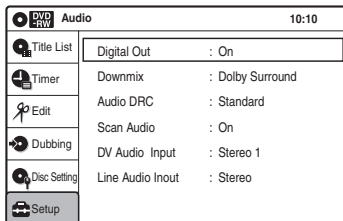

Digital Out

Selects if audio signals are output from the DIGITAL AUDIO OUT (OPTICAL or COAXIAL) jack.

<u>On</u>	Normally select this. Press ENTER, and select “Dolby Digital,” “DTS,” or “MPEG” for further settings (see below).
Off	The influence of the digital circuit upon the analogue circuit is minimum.

The following setup items switches the method of outputting audio signals when you connect a component such as an amplifier (receiver) with a digital input jack.

For connection details, see “Step 4: Connecting to Your AV Amplifier (Receiver)” on page 17.

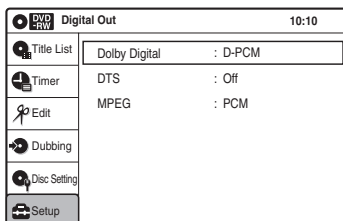

Note

If you connect a component that does not accept the selected audio signal, a loud noise (or no sound) will come out from the speakers, and may affect your ears or cause speaker damage.

◆Dolby Digital (DVDs only)

Selects the type of Dolby Digital signal.

<u>D-PCM</u>	Select this when the recorder is connected to an audio component lacking a built-in Dolby Digital decoder. You can select whether the signals conform to Dolby Surround or not by making adjustments to the “Downmix” item in “Audio” setup (page 104).
Dolby Digital	Select this when the recorder is connected to an audio component with a built-in Dolby Digital decoder.

◆DTS (DVD VIDEOS only)

Selects whether or not to output DTS signals.

<u>On</u>	Select this when the recorder is connected to an audio component with a built-in DTS decoder.
Off	Select this when the recorder is connected to an audio component without a built-in DTS decoder.

◆MPEG (DVD VIDEOS only)

Selects the type of MPEG audio signal.

<u>PCM</u>	Select this when the recorder is connected to an audio component without a built-in MPEG decoder. If you play MPEG audio sound tracks, the recorder outputs stereo signals via the DIGITAL AUDIO OUT (OPTICAL or COAXIAL) jack.
MPEG	Select this when the recorder is connected to an audio component with a built-in MPEG decoder.

Downmix (DVDs only)

Switches the method for mixing down to two channels when you play a DVD which has rear sound elements (channels) or is recorded in Dolby Digital format. For details on the rear signal components, see “A Connecting to audio L/R jacks” on page 18. This affects the output from the following jacks:

- LINE 2 OUT (AUDIO L/R), AUDIO OUT L/R jacks
- LINE 1-TV jack
- DIGITAL AUDIO OUT (OPTICAL or COAXIAL) jack only when “Dolby Digital” is set to “D-PCM.”

<u>Dolby Surround</u>	Normally select this position. Multi-channel audio signals are output to two channels for enjoying surround sounds.
Normal	Multi-channel audio signals are downmixed to two channels for use with your stereo.

Audio DRC (Dynamic Range Control) (DVDs only)

Makes the sound clear when the volume is turned down when playing a DVD that conforms to “Audio DRC.” This affects the output from the following jacks:

- LINE 2 OUT (AUDIO L/R), AUDIO OUT L/R jacks
- LINE 1-TV jack
- DIGITAL AUDIO OUT (OPTICAL or COAXIAL) jack only when “Dolby Digital” is set to “D-PCM.”

<u>Standard</u>	Normally select this.
Wide Range	Gives you the feeling of being at a live performance.

Scan Audio (DVDs only)

<u>On</u>	Outputs audio signals during FF1 fast-forward of a DVD disc with Dolby Digital soundtracks. For details, see page 38.
Off	Turns off the function. No sound is output during FF1 fast-forward.

Note

Sound will be interrupted during Scan Audio.

DV Audio Input

<u>Stereo 1</u>	Records original sound only. Normally select this when dubbing a DV format tape.
Stereo 2	Records additional audio only.
Mix	Records both original and additional sounds.

Note

Select “Stereo 2” or “Mix” if you have added a second audio channel when recording with your digital video camera.

Line Audio Input (for DVD-RWs in VR mode)

When recording from equipment connected to the LINE input jack to a DVD-RW (VR mode) disc in this recorder, select line input audio.

For details about bilingual recording, see page 47.

Stereo	Records stereo sound only.
<u>Bilingual</u>	Records the two different soundtracks on DVD-RWs (VR mode). You can select either soundtrack when playing back the disc.

Hint

Audio selected with the connected equipment is recorded on a disc other than DVD-RWs (VR mode).

Recording and VCR Settings (Features)

The “Features” setup allows you to change the tape length, auto play and auto repeat settings.

Select “Features” in the “Setup” display. The default settings are underlined.

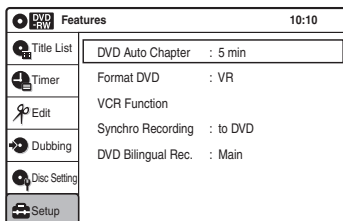

DVD Auto Chapter

Automatically divides a recording (a title) into chapters by inserting chapter markings at specified intervals. The markings are inserted while the recording is being made.

Off	No chapter mark is inserted.
<u>5 min</u>	Inserts chapter marks at approximately 5 minute intervals.
15 min	Inserts chapter marks at approximately 15 minute intervals.

Note

Actual intervals may differ depending on the size of the recording. The selected setting should be regarded as an approximate chapter interval.

Format DVD (DVD-RWs only)

Selects the format for an unused DVD-RW, when first inserted.

<u>VR</u>	Automatically formats the disc in VR mode.
Video	Automatically formats the disc in Video mode.

VCR Function

Press ENTER and select “Tape Length,” “Auto Play,” “Auto Repeat” or “Colour System.”

◆Tape Length

E180	For E180 or shorter length tapes.
<u>E240</u>	For E240 length tapes.
E260	For E260 length tapes.
E300	For E300 or longer length tapes.

◆Auto Play

<u>On</u>	Starts playback automatically, when you insert a tape with its safety tab removed.
Off	Turns off the function. You need to press ▷ (play) to start playback, even if you insert a tape with its safety tab removed.

◆Auto Repeat

On	Plays back a tape repeatedly. The VCR rewinds a tape to the beginning and restarts playback automatically.
<u>Off</u>	Turns off the function.

◆Colour System

<u>Auto</u>	Selects the colour system automatically. Normally select this. If streaks appear during playback, select the system that the tape was recorded in (below).
PAL	For a tape recorded in the PAL colour system.
B/W	For a tape recorded in black and white.
NT4.43	When playing an NTSC-recorded tape on a multi-system TV.
NTPB	When playing an NTSC-recorded tape on a PAL TV.

Synchro Recording

<u>to DVD</u>	Sets the recorder to record programmes from connected equipment that has a timer function (such as a satellite tuner) to a DVD disc.
to Video	Sets the recorder to record programmes from connected equipment that has a timer function (such as a satellite tuner) to a VHS tape.

DVD Bilingual Rec. (for all recordable discs except DVD-RWs in VR mode)

Selects the sound to be recorded on the disc. This setting is not necessary when recording on DVD-RWs (VR mode) that record both the main and sub sounds.

<u>Main</u>	Records the main sound for bilingual programmes.
Sub	Records the sub sound for bilingual programmes.

Language, Parental Control Settings/Factory Settings (Options)

The “Options” setup allows you to set up other operational settings.

Select “Options” in the “Setup” display. The default settings are underlined.

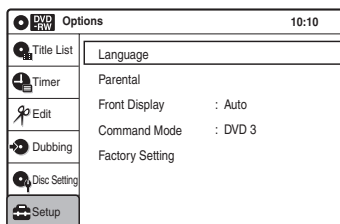

Language

◆ OSD (On-Screen Display)

Switches the display language on the screen.

◆ Disc Menu (DVD VIDEOS only)

Switches the language for the DVD menu.

◆ Audio (DVD VIDEOS only)

Switches the language of the soundtrack.

When you select “Original,” the language given priority in the disc is selected.

◆ Subtitle (DVD VIDEOS only)

Switches the language of the subtitles recorded on the disc.

When you select “Auto,” the subtitle language changes according to the language you selected for the soundtrack. See page 124 for an explanation of the language abbreviations.

💡 Hint

If you select “Others” for “Disc Menu,” “Audio,” or “Subtitle,” you can select from the additional 18 languages. Press **↑/↓** to select the desired language and press ENTER.

Note

If you select a language in “Disc Menu,” “Subtitle,” or “Audio” that is not recorded on the DVD VIDEO, one of the recorded languages will be automatically selected.

Parental (DVD VIDEOS only)

Playback of some DVD VIDEOS can be limited according to a predetermined level, such as the age of the users. Scenes may be blocked or replaced with different scenes.

- 1 Select "Parental," and press ENTER.
 - If you have not entered a password, the display for registering a new password appears.
Enter a 4-digit password using the number buttons.

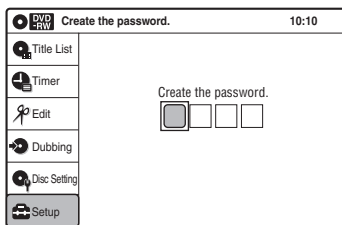

The display for confirming the password appears.
Re-enter the password.

- When you have already registered a password, the display for entering the password appears.
Enter a 4-digit password using the number buttons.

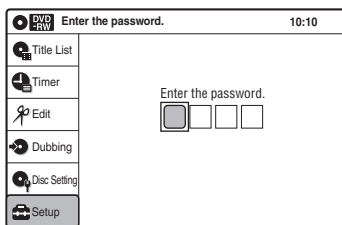

- 2 Select "Rating Level," and press ENTER.
The selection items for "Rating Level" are displayed.

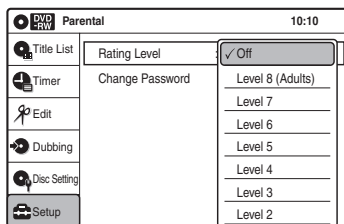

The lower the value, the stricter the limitation.

- 3 Select the level, and press ENTER.
The Parental setting is complete.

To cancel the Parental setting for the disc, set "Rating Level" to "Off" in step 2.

To change the password, select "Change Password" in step 2, and press ENTER. When the display for registering a password appears, enter a new four-digit password using the number buttons.

Notes

- If you forget your password, select "Factory Setting" in the "Options" setup.
- Playback of discs without the Parental Control function cannot be limited on this recorder.
- Depending on the disc, you may be asked to change the Parental Control level while playing the disc. In this case, enter your password, then change the level.

Front Display

Adjusts the lighting of the front panel display.

<u>Auto</u>	Adjusts to low lighting when power is off.
Bright	Maintains bright lighting when power is off.
Dimmer	Maintains low lighting regardless of whether the power is on or off.
Off	Turns off the lighting when power is off. Maintains the lighting when power is on.

Command Mode

Changes the command mode of this recorder if other DVD equipment is assigned the same command mode. Be sure to match the COMMAND MODE switch on the remote to the setting made here. For details, see "If you have a Sony DVD player or more than one Sony DVD recorder" on page 25.

DVD 1 DVD 2	Select the setting that does not conflict with other DVD equipment.
<u>DVD 3</u>	The default command mode of this recorder.

Factory Setting

Allows you to return the setup settings to their default settings. Note that all of your previous settings will be lost.

- 1 Select “Factory Setting,” and press ENTER.
- 2 Select “Start,” and press ENTER.
The setup settings return to their default settings.
- 3 Press ENTER when “Finish” appears.
The power automatically turns off and then on again, and the recorder is reset to the factory settings.
When the “Easy Setup” display appears, follow the instructions for Easy Setup (page 22) from step 4.

Easy Setup (Resetting the Recorder)

Select this to run the Easy Setup programme.

- 1 Select “Easy Setup” in the “Setup” display.



- 2 Select “Start,” and press ENTER.
- 3 Follow the instructions for Easy Setup (page 22) from step 4.

Troubleshooting

If you experience any of the following difficulties while using the recorder, use this troubleshooting guide to help remedy the problem before requesting repairs. Should any problem persist, consult your nearest Sony dealer.

Power

The power does not turn on.

- ➔ Check that the mains lead is connected securely.

Picture

There is no picture.

- ➔ Re-connect all connecting cords securely.
- ➔ The connecting cords are damaged.
- ➔ Check the connection to your TV (page 13).
- ➔ Switch the input selector on your TV (such as to "VIDEO") so that the signal from the recorder appears on the TV screen.
- ➔ If you connect the recorder to your TV via only the COMPONENT VIDEO OUT jacks, set "Component Out" in the "Video" setup to "On" (page 102).
- ➔ This recorder cannot record NTSC signals.

Picture noise appears.

- ➔ Check the connection to your TV (page 13) and switch the input selector on your TV so that the signal from the recorder appears on the TV screen.
- ➔ If the picture output signal from your recorder passes through your VCR to get to your TV, or if you are connected to a combination TV/VIDEO player, the copy-protection signal applied to some DVD programmes could affect picture quality. If you still experience this problem even when you connect your recorder directly to your TV, try connecting your recorder to your TV's S VIDEO input.
- ➔ You have set the recorder to progressive format (the PROGRESSIVE indicator lights up) even though your TV cannot accept the progressive signal. In this case, set "Progressive" to "Off" in the "Video" setup (page 102).
- ➔ Even if your TV is compatible with progressive format (525p/625p) signals, the image may be affected when you set the recorder to progressive

format. In this case, set "Progressive" to "Off" in the "Video" setup (page 102).

- ➔ You are playing a disc recorded in a colour system that is different from your TV.

TV programme reception does not fill the screen.

- ➔ Set the channel manually in "Tuner Preset" setup (page 98).
- ➔ Select the correct source using the INPUT SELECT button, or select a programme position of any TV programme using the PROG +/- buttons.

TV programme pictures are distorted.

- ➔ Reorient the TV aerial.
- ➔ Adjust the picture (see the TV's instruction manual).
- ➔ Place the recorder and TV farther apart.
- ➔ Place the TV and any bunched aerial cables farther apart.

TV programme positions cannot be changed.

- ➔ The programme position is disabled (page 99).
- ➔ A timer recording started, which cause the programme position to change.

The picture from equipment connected to the recorder's input jack does not appear on the screen.

- ➔ If the equipment is connected to the LINE 1-TV jack, select "LINE1" in the front panel display by pressing INPUT SELECT.

If the equipment is connected to the LINE 2 IN jacks, select "LINE2" in the front panel display by pressing INPUT SELECT.

If the equipment is connected to the LINE 3/ DECODER jack, select "LINE3" in the front panel display by pressing INPUT SELECT.

If the equipment is connected to the DV IN jack (this is usually for a digital video camera connection), select "DV" in the front panel display by pressing INPUT SELECT.

The playback picture or TV programme from the equipment connected through the recorder is distorted.

- ➔ If the playback picture output from a DVD player, VCR, or tuner goes through your recorder before reaching your TV, the copy-protection signal applied to some programmes could affect picture quality. Disconnect the playback

equipment in question and connect it directly to your TV.

The picture does not fill the screen.

- ➔ Set “TV Type” in the “Video” setup to fit the aspect ratio of your TV (page 101).

The picture does not fill the screen, even though the aspect ratio is set in “TV Type” in the “Video” setup.

- ➔ The aspect ratio of the disc is fixed on your DVD.

Sound

There is no sound.

- ➔ Re-connect all connections securely.
- ➔ The connecting cord is damaged.
- ➔ The input source setting on the amplifier or the connection to the amplifier is incorrect.
- ➔ The recorder is in reverse play, fast-forward, slow motion, or pause mode.
- ➔ If the audio signal does not come through the DIGITAL AUDIO OUT (OPTICAL or COAXIAL) jack, check the “Audio” setup settings (page 103).

Sound is noisy.

- ➔ When playing a CD with DTS soundtracks, noise will come from the LINE 2 OUT (AUDIO L/R) jacks, AUDIO OUT L/R jacks, or LINE 1-TV jack (page 37).

The sound volume is low.

- ➔ The sound volume is low on some DVDs. The sound volume may improve if you set “Audio DRC” in the “Audio” setup to “Wide Range” (page 104).

An alternate audio track cannot be recorded or played.

- ➔ When recording from connected equipment, set “Line Audio Input” in the “Audio” setup to “Bilingual”(page 104).
- ➔ Multilingual tracks (main and sub) cannot be recorded on DVD+RWs, DVD-RWs (Video mode), DVD+Rs, or DVD-Rs. To record the language, select “Main” or “Sub” of “DVD Bilingual Rec.” in the “Features” setup before recording (page 106). To record both the main and sub sounds, record on a DVD-RW (VR mode).
- ➔ If you have connected an AV amplifier to the DIGITAL AUDIO OUT (OPTICAL or

COAXIAL) jack and want to change the audio track for a DVD-RW (VR mode) during playback, set “Digital Out” – “Dolby Digital” to “D-PCM” in the “Audio” setup (page 103).

DVD Playback

The disc does not play.

- ➔ The disc is upside down. Insert the disc with the labelled side facing up.
- ➔ The disc is not correctly inserted.
- ➔ Moisture has condensed inside the recorder. Remove the disc and leave the recorder turned on for about half an hour until the moisture evaporates.
- ➔ If the disc was recorded on another recorder, the recorder cannot play the disc if it was not finalized (page 91).

The disc does not start playback from the beginning.

- ➔ Resume play was activated (page 38).
- ➔ You have inserted a disc whose Title menu or DVD menu automatically appears on the TV screen when it is first inserted. Use the menu to start playback.

The recorder starts playing the disc automatically.

- ➔ The DVD VIDEO features an auto playback function.

Playback stops automatically.

- ➔ If the disc has an auto pause signal, the recorder stops playback at the auto pause signal.

Some functions such as Stop, Search, or Slow-motion Play cannot be performed.

- ➔ Depending on the disc, you may not be able to do some of the operations above. See the instruction manual supplied with the disc.
- ➔ While the recorder is reading disc information, playback operations will not work.

The language for the soundtrack cannot be changed.

- ➔ Multilingual tracks are not recorded on the disc being played.
- ➔ The DVD VIDEO prohibits the changing of the language for the soundtrack.
- ➔ Try changing the language using the DVD VIDEO’s menu.

The subtitle language cannot be changed or turned off.

- ➔ Multilingual subtitles are not recorded on the DVD VIDEO.
- ➔ The DVD VIDEO prohibits changing of the subtitles.
- ➔ Try changing the subtitle using the DVD VIDEO's menu.
- ➔ The subtitles cannot be changed for the titles recorded on this recorder.

The angles cannot be changed.

- ➔ Multi-angles are not recorded on the DVD VIDEO being played.
- ➔ You are trying to change the angles when “” does not appear in the front panel display (page 35).
- ➔ The DVD VIDEO prohibits changing angles.
- ➔ Try changing the angle using the DVD VIDEO's menu.
- ➔ The angles cannot be changed for the titles recorded on this recorder.

The MP3 audio track cannot be played.

- ➔ The DATA CD is not recorded in the MP3 format that conforms to ISO9660 Level 1/ Level 2.
- ➔ The MP3 audio track does not have the extension “.MP3.”
- ➔ The data is not formatted in MP3 even though it has the extension “.MP3.”
- ➔ The data is not MPEG1 Audio Layer 3 data.
- ➔ The recorder cannot play audio tracks in MP3PRO format.

The JPEG image file cannot be played.

- ➔ The DATA CD is not recorded in a JPEG format that conforms to ISO9660 Level 1/Level 2.
- ➔ The JPEG image file does not have the extension “.JPG” or “.JPEG.”
- ➔ The data is not formatted in JPEG even though it has the extension “.JPG” or “.JPEG.”
- ➔ The length or width of the image is more than 4,720 dots.

The title of the MP3 audio album/ track or JPEG image folder/file is not correctly displayed.

- ➔ The recorder can only display numbers and alphabet. Other characters are displayed as asterisks.

DVD Recording/Timer recording/ Editing**The programme position cannot be changed from the channel you are recording.**

- ➔ Set the TV's input source to “TV.”

Recording does not start immediately after**● REC is pressed.**

- ➔ Operate the recorder only after “LOAD,” “FORMAT,” or “INF WRITE” disappears from the front panel display.

Nothing was recorded even though the timer setting is set correctly.

- ➔ The recorder was already turned on at the timer recording start time. Set the recorder to standby mode before timer recording starts.
- ➔ There was a power failure during recording.
- ➔ Disconnect the mains lead from the mains, and connect it again.
- ➔ The programme contains copy protection signals that restrict copying.
- ➔ The programme that starts first has priority and the second programme starts recording only after the first programme has finished. If the programmes start at the same time, the programme listed first in the menu has priority (page 51).
- ➔ There is no DVD inserted in the recorder.
- ➔ There is not enough disc space for the recording.

Recording does not stop immediately after ■ (stop) is pressed.

- ➔ It will take a few seconds for the recorder to input disc data before recording can stop.

Timer recording is not complete or did not start from the beginning.

- ➔ There was a power failure during recording. If the power recovers when there is a timer recording, the recorder resumes recording.
- ➔ The programme that starts first has priority and the second programme starts recording only after the first programme has finished. If the programmes start at the same time, the programme listed first in the menu has priority (page 51).
- ➔ There is not enough disc space for the recording.

The \odot indicator flashes after timer recording is set.

- ➔ Insert a recordable disc (page 30).
- ➔ Insert a disc with enough space for the recording.
- ➔ The disc has 99 or more titles, which prevents further recording.
- ➔ The disc is protected (page 69).

The SYNCHRO REC indicator flashes after Synchro-Recording is set.

- ➔ Insert a recordable disc (page 30).
- ➔ Insert a disc with enough space for the recording.
- ➔ The disc has 99 or more titles, which prevents further recording.
- ➔ The disc is protected (page 69).

Contents previously recorded were erased.

- ➔ Data that has been recorded on a DVD with a PC will be erased from the disc when the disc is inserted.

VCR Playback

The playback picture does not appear on the TV screen.

- ➔ Make sure the TV is set to the channel for the VCR. If you are using a monitor, set it to video input.

The picture is not clear.

- ➔ Adjust the tracking by the TRACKING +/- buttons.
- ➔ Set "Colour System" in the "Features" setup correctly to match the colour system that the tape was recorded in (page 105).
- ➔ The video heads are dirty (see page 114). Clean the video heads using a Sony video head cleaning cassette. If a Sony cleaning cassette is not available in your area, have the heads cleaned at your nearest Sony dealer (a standard service fee will be charged). Do not use a commercially available liquid type cleaning cassette, as it may damage the video heads.
- ➔ The video heads may have to be replaced. Consult your local Sony dealer for more information.
- ➔ The tape is defective.

The picture rolls vertically during picture search.

- ➔ Adjust the vertical hold control on the TV or monitor.

The picture has no sound.

- ➔ The tape is defective.
- ➔ Check the audio cord connection.

A tape cannot be inserted.

- ➔ Check that a tape is not already in the tape compartment.

VCR Recording

The programme position cannot be changed from the one you are recording.

- ➔ Set the TV's input source to "TV."

No TV programme appears on the TV screen.

- ➔ Make sure the TV is set to the channel for the VCR. If a monitor is used, set it to video input.
- ➔ Select the correct source with the PROG +/- or INPUT SELECT buttons. Select a programme position number when recording TV programmes; select "LINE1," "LINE2," or "LINE3" when recording from other equipment.

TV reception is poor.

- ➔ Adjust the TV aerial.

The tape starts playing as soon as it is inserted.

- ➔ The safety tab has been removed. To record on this tape, cover the tab hole.

The tape is ejected when ● REC is pressed.

- ➔ Check that the safety tab has not been removed.

Nothing happens when ● REC is pressed.

- ➔ Make sure the tape is not at its end.

VCR Timer recording

The timer does not operate.

- ➔ Check that the clock is set.
- ➔ Make sure a tape has been inserted.
- ➔ Check that the safety tab has not been removed.
- ➔ Make sure the tape is not at its end.
- ➔ Make sure a programme has been set for timer recording.
- ➔ Make sure the timer settings are set for a future time.
- ➔ Check that the satellite or digital tuner is turned on.
- ➔ "- :- -" appears in the front panel display if the

recorder is disconnected from the mains for more than one minute. Reset the clock and timer.

- ➔ Turn the power off and unplug the mains lead.
- ➔ The recorder was already turned on at the timer recording start time. Set the recorder to standby mode before timer recording starts.
- ➔ The programme that starts first has priority and the second programme starts recording only after the first programme has finished. If the programmes start at the same time, the programme listed first in the menu has priority (page 80).

The ⊖ indicator flashes after timer recording is set.

- ➔ Check that the safety tab has not been removed.

The SYNCHRO REC indicator flashes after Synchro-Recording is set.

- ➔ Check that the safety tab has not been removed.

Display

Menus or displays do not appear on the screen.

- ➔ While the recorder is reading disc information, the System Menu, TOOLS menu, or information display will not appear.

“- :- -” appears in the front panel display.

- ➔ Set the clock again (page 100).

The ⊖ indicator is flashing.

- ➔ The disc does not have enough space.
- ➔ Insert a recordable disc or a tape with its safety tab in place inside the recorder.

Remote control

The remote does not function.

- ➔ Batteries are weak.
- ➔ The remote is too far from the recorder.
- ➔ The remote's manufacturer code returned to the default setting when you replaced the batteries. Reset the code (page 20).
- ➔ Turn on the recorder.
- ➔ The remote is not pointed at the remote sensor on the recorder.
- ➔ Different command modes are set for the recorder and remote. Set the same command mode (page 25).
- ➔ Slide the TV/DVD-VIDEO switch to DVD-VIDEO (page 20).

Other Sony equipment responds to the remote.

- ➔ The same command mode is set for both the Sony DVD equipment. Set a different command mode for the recorder (page 25).

Others

The recorder does not operate properly.

- ➔ Restart the recorder. Press down **I/⏻** on the recorder for more than ten seconds until “SONY DVD” appears in the front panel display.
- ➔ When static electricity, etc., causes the recorder to operate abnormally, turn off the recorder and wait until the clock appears in the front panel display. Then, unplug the recorder and after leaving it off for a while, plug it in again.

The disc tray does not open after you press **⏏** (open/close).

- ➔ It may take a few seconds for the disc tray to open after you have recorded or edited a disc. This is because the recorder is adding disc data to the disc.

The disc tray does not open and “TRAY LOCKED” appears in the front panel display.

- ➔ Contact your Sony dealer or local authorized Sony service facility.

“CAN NOT RECORD BECAUSE OF HIGH TEMP.” appears in the front panel display.

- ➔ Check that the vent on the rear of the recorder is not blocked. Then, turn off the recorder, wait until the clock appears in the front panel display, and disconnect the mains lead. Leave the recorder off for a while, then re-connect the mains lead, and press **I/⏻** on the recorder.

“CHILD LOCK” appears in the front panel display.

- ➔ The recorder is locked. Cancel the Child Lock (page 39).

Notes About This Recorder

On adjusting volume

Do not turn up the volume while listening to a section with very low level inputs or no audio signals. If you do, the speakers may be damaged when a peak level section is played.

On cleaning

Clean the cabinet, panel, and controls with a soft cloth slightly moistened with a mild detergent solution. Do not use any type of abrasive pad, scouring powder or solvent such as alcohol or benzine.

On cleaning discs, disc/lens cleaners

Do not use a commercially available cleaning disc or disc/lens cleaner (liquid or spray type). These may cause the apparatus to malfunction.

Notes about the discs

- To keep the disc clean, handle the disc by its edge. Do not touch the surface. Dust, fingerprints, or scratches on the disc may cause it to malfunction.



- Do not expose the disc to direct sunlight or heat sources such as hot air ducts, or leave it in a car parked in direct sunlight as the temperature may rise considerably inside the car.
- After playing, store the disc in its case.
- Clean the disc with a cleaning cloth. Wipe the disc from the centre out.



- Do not use solvents such as benzine, thinner, commercially available disc/lens cleaners, or anti static spray intended for vinyl LPs.
- Do not use the following discs.
 - A disc that has a non-standard shape (e.g., card, heart).
 - A disc with a label or sticker on it.

- A disc that has cellophane tape or sticker adhesive on it.

Symptoms caused by contaminated video heads



When the video heads are dirty, clean the video heads using a Sony video head cleaning cassette. If a Sony cleaning cassette is not available in your area, have the heads cleaned at your nearest Sony dealer (a standard service fee will be charged). Do not use a commercially available liquid type cleaning cassette, as it may damage the video heads.

Specifications

System

[DVD recorder section]

Laser

Semiconductor laser

Audio recording format

Dolby Digital

Video recording format

MPEG Video

[VCR section]

Format

VHS PAL standard

Video recording system

Rotary head helical scanning FM system

Video heads

Double azimuth four heads

Tape speed

SP: PAL 23.39 mm/s

LP: PAL 11.70 mm/s

EP: NTSC 11.12 mm/s,
playback only

Maximum recording/playback time

10 hrs. in LP mode (with E300 tape)

Rewind time

Approx. 1 min (with E180 tape)

[Tuner section]

Channel coverage

PAL (I)

VHF: Ireland A to J, South Africa 4 to 13

UHF: B21 to B69

CATV: S01 to S05, S1 to S20

HYPER: S21 to S41

The above channel coverage merely ensures the channel reception within these ranges. It does not guarantee the ability to receive signals in all circumstances.

Aerial out

75-ohm asymmetrical aerial socket

[Timer section]

Clock

Quartz locked

Timer indication

24-hour cycle

Timer setting

12 programmes in total (max.)

Inputs and outputs

LINE 2 IN

VIDEO IN, phono jack (1)

Input signal: 1 Vp-p, 75 ohms, unbalanced,
sync negative

AUDIO IN, phono jacks (2)

Input level: 327 mVrms

Input impedance: more than 47 kilohms

S VIDEO, 4-pin, mini-DIN jack (1)

Y: 1.0 Vp-p, unbalanced, sync negative

C: 0.286 Vp-p, load impedance 75 ohms

LINE OUT

VIDEO OUT, phono jack (1)

Output signal: 1 Vp-p, 75 ohms,
unbalanced, sync negative

AUDIO OUT, phono jacks (2)

Standard output: 327 mVrms

Load impedance: 47 kilohms

Output impedance: less than 10 kilohms

LINE 1 -TV

21-pin

CVBS IN/OUT

RGB OUT (upstream)

LINE 3/DECODER

21-pin

CVBS IN/OUT

RGB IN (downstream)

Decoder

DV IN

4-pin/i.LINK S100

DIGITAL AUDIO OUT

OPTICAL, Optical output jack

-18 dBm (wave length: 660 nm)

COAXIAL, phono jack

Output signal: 0.5 Vp-p, 75 ohms

COMPONENT VIDEO OUT (Y, P_B/C_B, P_R/C_R)

Phono jack

Y: 1.0 V_{p-p}, P_B/C_B, P_R/C_R: 0.7 V_{p-p}, 75 ohms

S VIDEO OUT

4-pin, mini-DIN jack

Y: 1.0 V_{p-p}, unbalanced, sync negative

C: 0.286 V_{p-p}, load impedance 75 ohms

General

Power requirements

220-240 V AC, 50 Hz

Power consumption

40 W

Power back-up

Back-up duration: 0 min

Operating temperature

5°C to 35°C

Storage temperature

-20°C to 60°C

Operating humidity

25% to 80%

Dimensions including projecting parts and controls (w/h/d)

Approx. 430 × 85 × 334 mm

Mass

Approx. 4.9 kg

Supplied accessories

Remote commander (remote) (1)

R6 (size AA) batteries (2)

Aerial cable (1)

Audio/video cord (1)

Design and specifications are subject to change without notice.

Compatible colour systems

[DVD recorder section]

This recorder is designed to record using the PAL colour system and play back using the PAL or NTSC colour systems.

The signals of the SECAM colour system can be received or recorded but played back in the PAL colour system only.

[VCR section]

This recorder is designed to record and play back using the PAL colour system.

Recording of video sources based on other colour systems cannot be guaranteed.

About i.LINK

The DV IN jack on this recorder is an i.LINK-compliant DV IN jack. This section describes the i.LINK standard and its features.

What is i.LINK?

i.LINK is a digital serial interface for handling digital video, digital audio and other data in two directions between equipment having the i.LINK jack, and for controlling other equipment.

i.LINK-compatible pieces of equipment can be connected by a single i.LINK cable. Possible applications are operations and data transactions with various digital AV equipment. When two or more i.LINK-compatible equipment are connected to this recorder in a daisy chain, operations and data transactions are possible with not only the equipment that this recorder is connected to but also with other devices via the directly connected equipment.

Note, however, that the method of operation sometimes varies according to the characteristics and specifications of the equipment to be connected, and that operations and data transactions are sometimes not possible on some connected equipment.

Note

Normally, only one piece of equipment can be connected to this recorder by the i.LINK cable (DV connecting cable). When connecting this recorder to i.LINK-compatible equipment having two or more i.LINK jacks (DV jacks), see the instruction manual of the equipment to be connected.

About the name “i.LINK”

i.LINK is a more familiar term for IEEE 1394 data transport bus proposed by SONY, and is a trademark approved by many corporations. IEEE 1394 is an international standard standardized by the Institute of Electrical and Electronics Engineers.

i.LINK baud rate

i.LINK's maximum baud rate varies according to the equipment. Three maximum baud rates are defined:

- S100 (approx. 100 Mbps*)
- S200 (approx. 200 Mbps)
- S400 (approx. 400 Mbps)

The baud rate is listed under “Specifications” in the instruction manual of each equipment. It is also indicated near the i.LINK jack on some equipment.

The maximum baud rate of equipment on which it is not indicated such as this unit is “S100.”

When units are connected to equipment having a different maximum baud rate, the baud rate sometimes differs from the indicated baud rate.

* What is Mbps?

Mbps stands for megabits per second, or the amount of data that can be sent or received in one second. For example, a baud rate of 100 Mbps means that 100 megabits of data can be sent in one second.

i.LINK functions on this recorder

For details on how to dub when this recorder is connected to other video equipment having DV jacks, see page 93.

The DV jack on this recorder can only input DVC-SD signals. It cannot output signals. The DV jack will not accept MICRO MV signals from equipment such as a MICRO MV digital video camera with an i.LINK jack.

For further precautions, see the notes on page 93. For details on precautions when connecting this recorder, also see the instruction manuals for the equipment to be connected.

Required i.LINK cable

Use the Sony i.LINK 4-pin-to-4-pin cable (during DV dubbing).

i.LINK and  are trademarks.

Guide to Parts and Controls

For more information, see the pages in parentheses.

Front panel

Buttons on the recorder have the same function as the buttons on the remote if they have the same or similar names.

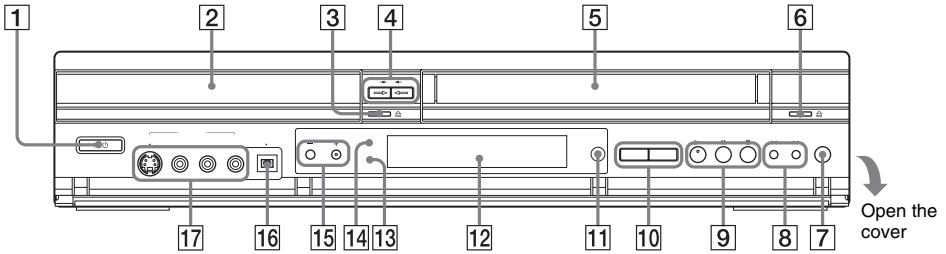

- 1** I/⏻ (on/standby) button (22)
- 2** Disc tray (34, 48, 87)
- 3** ≡ (open/close) button (35, 48, 87)
- 4** DVD → button (88)
← VIDEO button (87)
- 5** Tape compartment (70, 77)
- 6** ≡ (eject) button (70)
- 7** ● REC (record) button (48, 77)
- 8** ◀▶ (rewind/fast-forward) buttons (37)
- 9** ▷ (play) button (34, 70)*
 - ▬ (pause) button (35, 48, 72, 77)
 - (stop) button (34, 48, 70, 77)
- 10** SELECT DVD/VIDEO buttons (34, 48, 70, 77)
- 11** □ (remote sensor) (19)
- 12** Front panel display (46, 74)
- 13** SYNCHRO REC indicator (54, 82)
- 14** PROGRESSIVE indicator (16, 102)
- 15** PROGRAM/TRACKING +/- buttons* (20, 48, 71, 77)
- 16** DV IN jack (93)
- 17** LINE 2 IN (S VIDEO/Ⓜ) (video)/Ⓜ (audio) L/R) jacks (26)

* ▷ and PROGRAM + buttons have a tactile dot. Use the tactile dot as a reference.

Remote

For DVD functions

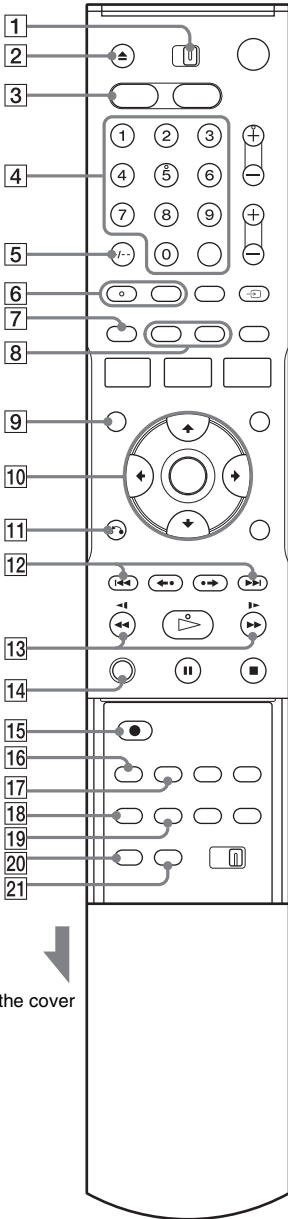

Slide the cover

Buttons with an orange dot next to them can be used with your TV when the TV/DVD-VIDEO switch is set to TV.

- 1** TV/DVD-VIDEO switch (20)
- 2** ▲ (open/close) button (34, 48)
- 3** DVD button (34, 48)
- 4** Number buttons ^{*1}(20, 52)
SET button ^{*2}
- 5** CLEAR / -/-- (ten digit) button (41)
- 6** ○○○ (audio) button (35) ^{*1}
⋮ (subtitle) button (35)
- 7** ORIGINAL/PLAYLIST button (39, 59)
- 8** DISPLAY button (45)
TIME/TEXT button (46)
- 9** TOP MENU button (34)
- 10** ↑/↓/←/→/ENTER button (22)
- 11** ↶ RETURN button (22)
- 12** ◀◀ (previous)/▶▶ (next) buttons (35)
- 13** ◀◀◀/▶▶▶ (search) buttons (35)
- 14** ZOOM button (35)
- 15** ● REC (record) button (48)
- 16** REC MODE button (48, 94)
- 17** SYNCHRO REC button (54)
- 18** ∞ (angle) button (35)
- 19** REPEAT button (35)
- 20** MARKER button (41)
- 21** SEARCH button (41)

^{*1} Number 5 and ○○○ buttons have a tactile dot. Use the tactile dot as a reference.

^{*2} SET button does not work for this model.

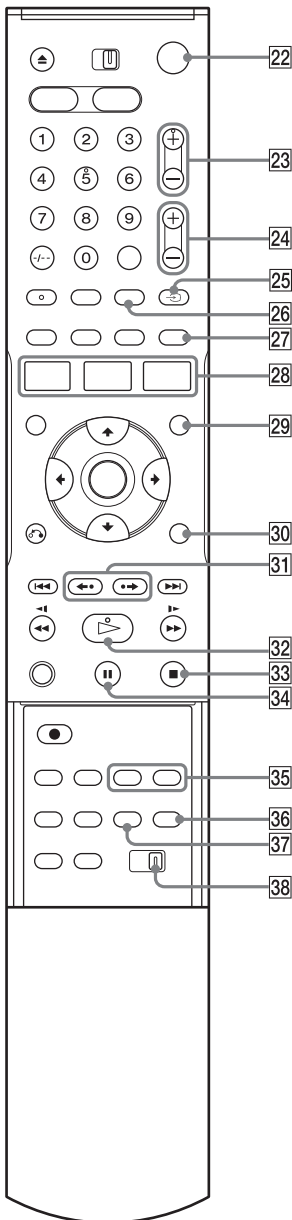

- 3** I/⏻ (on/standby) button (22)
- 4** PROG (programme) +/- buttons* (20, 48)
- 5** ◀ (volume) +/- buttons (20)
- 6** ↶ TV/VIDEO button (20)
- 7** INPUT SELECT button (48, 57, 94)
- 27** SUR (surround) button (35)
- 28** SYSTEM MENU button (10)
TITLE LIST button (39, 59)
TIMER button (50)
- 29** MENU button (34)
- 30** TOOLS button (11, 40)
- 31** ◀◀ (replay)/▶▶ (advance) buttons (35)
- 32** ▷ (play) button* (34)
- 33** ■ (stop) button (34, 48)
- 34** || (pause) button (48)
- 35** CHAPTER MARK/CHAPTER MARK
ERASE buttons (62)
- 36** ◻ (wide mode) button (20)
- 37** ONE TOUCH DUBBING button (96)
- 38** COMMAND MODE switch (DVD 1, 2, 3)
(25)

* PROG + and ▷ buttons have a tactile dot. Use the tactile dot as a reference.

Slide the cover

For VCR functions

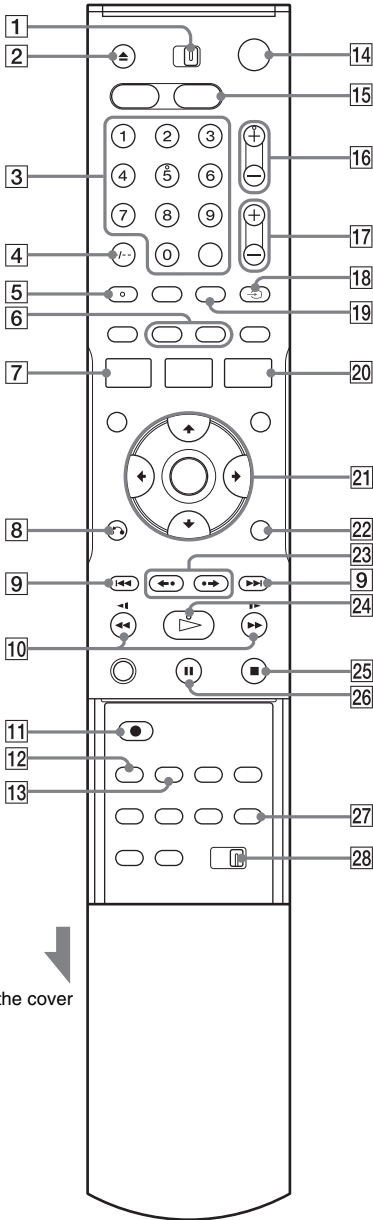

Slide the cover

- 1 TV/DVD·VIDEO switch (20)
- 2 ▲ (eject) button (70)
- 3 Number buttons (20, 81)^{*1}
SET button^{*2}
- 4 CLEAR / -/-- (ten digit) button (70)
- 5 ○○○ (audio) button^{*1} (75)
- 6 DISPLAY button (74)
TIME/TEXT button (74)
- 7 SYSTEM MENU button (10)
- 8 ↶ RETURN button (22)
- 9 ◀◀ (previous)/▶▶ (next)
buttons (72)
- 10 ◀◀◀/▶▶▶ (search) buttons (72)
- 11 ● REC (record) button (77)
- 12 REC MODE button (77)
- 13 SYNCHRO REC button (82)
- 14 I/⏻ (on/standby) button (22)
- 15 VIDEO button (70, 77)
- 16 PROG (programme)/TRACKING +/-
buttons^{*1}(20, 71, 77)
- 17 ▲ (volume) +/- buttons (20)
- 18 ↶ TV/VIDEO button (20)
- 19 INPUT SELECT button (77, 85)
- 20 TIMER button (79)
- 21 ↑/↓/←/→/ENTER button (22)
- 22 TOOLS button (73)
- 23 ◀● (replay)/●▶ (advance) buttons (72)
- 24 ▷ (play) button^{*1} (70)
- 25 ■ (stop) button (70, 77)
- 26 || (pause) button (72, 77)
- 27 🔄 (wide mode) button (20)
- 28 COMMAND MODE switch (DVD 1, 2, 3)
(25)

^{*1} Number 5, ○○○, PROG +, and ▷ buttons have a tactile dot. Use the tactile dot as a reference.

^{*2} SET button does not work for this model.

Front panel display

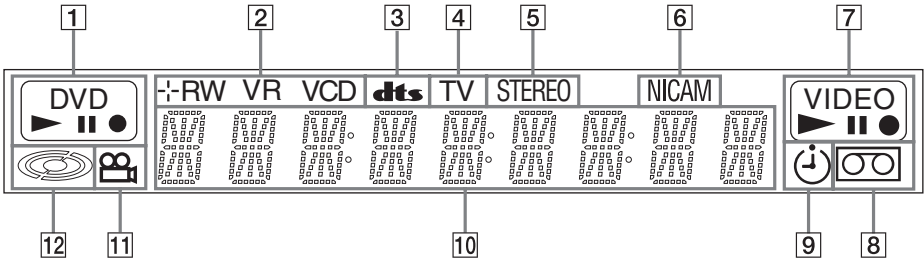

- 1** DVD playing/recording status
- 2** Disc type/recording format
- 3** Audio signal indicators
- 4** TV indicator (20)
- 5** STEREO indicator (47)
- 6** NICAM indicator (47)
- 7** VIDEO playing/recording status
- 8** Tape indicator
- 9** Timer indicator
- 10** Displays the following (46, 74):
 - Playing time/remaining time
 - Current title/chapter/track/index number
 - Recording time/recording mode
 - Clock
 - Programme position
- 11** (angle) indicator (35)
- 12** Disc indicator

Rear panel

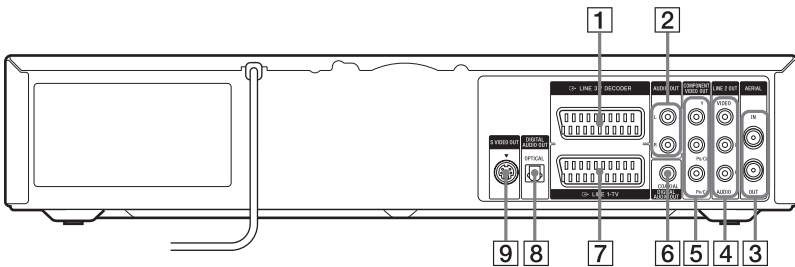

- 1** LINE 3/DECODER jack (28)
- 2** AUDIO OUT L/R jacks (17)
- 3** AERIAL IN/OUT jacks (13)
- 4** LINE 2 OUT (VIDEO/AUDIO L/R) jacks (14, 16)
- 5** COMPONENT VIDEO OUT (Y, Pb/Cb, Pr/Cr) jacks (16)
- 6** DIGITAL AUDIO OUT (COAXIAL) jack (17)
- 7** LINE 1-TV jack (15)
- 8** DIGITAL AUDIO OUT (OPTICAL) jack (17)
- 9** S VIDEO OUT jack (14)

Glossary

Chapter (page 40)

Sections of a picture or a music feature that are smaller than titles. A title is composed of several chapters. Depending on the disc, no chapters may be recorded.

Copy protection signals (page 48)

Copy restriction set by copyright owners, etc. These signals are included in some software or TV programs and restrict recording on this recorder.

Dolby Digital (page 103)

Digital audio compression technology developed by Dolby Laboratories. This technology conforms to multi-channel surround sound. The rear channel is stereo and there is a discrete subwoofer channel in this format. Dolby Digital provides the same discrete channels of high quality digital audio found in “Dolby Digital” theater surround sound systems. Good channel separation is realized because all of the channel data is recorded discretely, and little deterioration occurs because all channel data processing is digital.

DTS (page 103)

Digital audio compression technology by Digital Theater Systems, Inc. This technology conforms to multi-channel surround sound. The rear channel is stereo and there is a discrete subwoofer channel in this format. DTS provides the same discrete channels of high quality digital audio. Good channel separation is realized because all of the channel data is recorded discretely, and little deterioration occurs because all channel data processing is digital.

DVD+RW (page 30)

A DVD+RW (read “plus RW”) is a recordable and rewritable disc. DVD+RWs use a recording format that is comparable to the DVD VIDEO format.

DVD-RW (page 30)

A DVD-RW is a recordable and rewritable disc that is the same size as a DVD VIDEO. The DVD-RW has two different modes: VR mode and Video mode. DVDs created in Video mode have the same format as a DVD VIDEO, while discs created in VR (Video Recording) mode allow the contents to be programmed or edited.

DVD+R (page 30)

A DVD+R (read “plus R”) is a recordable disc that is the same size as a DVD VIDEO. Contents can be recorded only once to a DVD+R, and will have the same format as a DVD VIDEO.

DVD-R (page 30)

A DVD-R is a recordable disc that is the same size as a DVD VIDEO. Contents can be recorded only once to a DVD-R, and will have the same format as a DVD VIDEO.

DVD VIDEO (page 32)

A disc that contains up to eight hours of moving pictures on a disc the same diameter as a CD. The data capacity of a single-layer and single-sided DVD is 4.7 GB (Giga Byte), which is 7 times that of a CD. The data capacity of a double-layer and single-sided DVD is 8.5 GB, a single-layer and double-sided DVD is 9.4 GB, and double-layer and double-sided DVD is 17 GB. The picture data uses the MPEG 2 format, which is a worldwide standard of digital compression technology. The picture data is compressed to about 1/40 (average) of its original size. The DVD also uses a variable rate coding technology that changes the data to be allocated according to the status of the picture. Audio information is recorded in a multi-channel format, such as Dolby Digital, allowing you to enjoy a more real audio presence.

Furthermore, various advanced functions such as the multi-angle, multilingual, and Parental Control functions are provided on the DVD.

Interlace format

Interlace format shows every other line of an image as a single “field” and is the standard method for displaying images on television. The even number field shows the even numbered lines of an image, and the odd numbered field shows the odd numbered lines of an image.

Original (page 58)

Titles actually recorded on a DVD-RW (VR mode). Erasing original titles frees up disc space.

Playlist (page 58)

Playback information created from the actual recordings on a DVD-RW (VR mode). A Playlist leaves the original titles as they are, and contains only the information needed to control playback. A Playlist title takes up very little disc space.

Progressive format (page 102)

Compared to the Interlace format that alternately shows every other line of an image (field) to create one frame, the Progressive format shows the entire image at once as a single frame. This means that while the Interlace format can show 30 frames/60 fields in one second, the Progressive format can show 60 frames in one second. The overall picture quality increases and still images, text, and horizontal lines appear sharper.

Title (page 40)

The longest section of a picture or music feature on a DVD, movie, etc., in video software, or the entire album in audio software.

Track (page 40)

Sections of a music feature on a CD (the length of a song).

DVD Audio/Subtitle Language

When you play a DVD VIDEO, the language of the selected audio track or subtitle is abbreviated as follows. See page 106 to change the audio track or subtitle.

ARA	Arabic	ITA	Italian
BUL	Bulgarian	IWR	Hebrew
CHI	Chinese	JPN	Japanese
CRO	Croatian	KOR	Korean
CZE	Czech	MAL	Malay
DAN	Danish	NLD	Dutch
DEU	German	NOR	Norwegian
ENG	English	POL	Polish
ESP	Spanish	POR	Portuguese
FIN	Finish	RUS	Russian
FRA	French	SVE	Swedish
GRE	Greek	THA	Thai
HUN	Hungarian	TUR	Turkish
IDN	Indonesian	VIE	Vietnamese
IND	Hindi	ZAF	Afrikaans
ISL	Icelandic		

Index

Words in quotations appear in the on-screen displays.

Numerics

- 16:9 23, 101
- 4:3 Letter Box 23, 101
- 4:3 Pan Scan 23, 101

A

- "A-B Erase" 60
- "Add" 68
- Aerial 13
- Album 42
- Angle 35
- "Audio" 106
- Audio 35
- "Audio DRC" 104
- "Audio" setup 103
- "Auto Adjust" 100
- Auto Clock Set 100
- "Auto Play" 105
- "Auto Preset" 98
- "Auto Repeat" 105

B

- Batteries 19
- Bilingual recording 47, 76
- Bookmark 41

C

- Changing/cancelling timer settings (Timer List) 55, 84
- Channel List 99
- Chapter 40, 123
- CHAPTER MARK 62
- CHAPTER MARK ERASE 62
- Child Lock 39
- Cleaning discs 114
- Cleaning the video heads 114
- Clock 22
- "Clock Set" setup 100
- Colour systems 105, 116
- "Combine Titles" 66
- "Command Mode" 25, 107

- "Component Out" 102
- COMPONENT VIDEO OUT 16
- Connecting
 - the aerial cable 13
 - the audio cords 17
 - to your TV 14
- Controlling TVs with the remote 20
- Copy protection 48, 123
- Copy-Free 48
- Copy-Never 48
- Copy-Once 48
- Counter 70
- CPRM 30
- "Create Playlist" 64
- Creating chapters 50, 62

D

- DATA CD 32, 42
- DATA DVD 32, 42
- "Del" 56, 84
- DIGITAL AUDIO OUT 17
- "Digital Out" 103
- Digital video camera 93
- "Disc Finalize" 69, 92
- "Disc Format" 69
- "Disc Information" 69
- "Disc Menu" 106
- "Disc Name" 69
- "Disc Protect" 69
- Disc types 30
- Display
 - front panel display 122
 - Setup Display 97
- "Divide Title" 61
- Dolby Digital 24, 103, 123
- "Downmix" 104
- DTS 24, 37, 103, 123
- "Dubbing" 87, 89
- "DV Audio Input" 95, 104
- "DV Dubbing" 95
- DV IN 93
- "DVD Auto Chapter" 105
- "DVD Bilingual Rec." 106
- DVD VIDEO 32, 123
- DVD+R 30, 123
- DVD+R DL 30
- DVD+RW 30, 123

- DVD-R 30, 123
- DVD-RW 30, 123

E

- Easy Setup 22, 108
- "Edit" 56, 84
- "Edit Playlist" 66
- "Edit Scene" 66
- Enter characters 63
- EP mode 70
- "Erase" 60, 67
- "Erase All Titles" 69
- Erasing
 - A-B Erase 60
 - all titles 69
 - chapters 60
 - titles 60

F

- "Factory Setting" 108
- Fast forward 36, 72
- Fast reverse 36, 72
- "Features" setup 105
- "Format DVD" 105
- "Front Display" 107
- Front panel 118
- Front panel display 122

H

- Handling discs 114

I

- i.LINK 93, 117
- INPUT SELECT 57, 85, 94
- Interlace format 124

J

- JPEG image files 43

L

- "Language" 106
- Language abbreviation 124
- "Line 1 Output" 101
- LINE 1-TV 15
- LINE 2 IN 26
- LINE 3/DECODER 28
- "Line Audio Input" 54, 57, 104

LP mode 76

M

Mains lead 19

Manual clock set 100

“Manual Set” 98

MARKER 41

MENU 34

Menu

Top menu 34

“Modify” 67

“Move” 68

MP3 audio tracks 42

MPEG 103

N

NICAM 47, 76

Number buttons 20, 40, 52,
81

O

One Touch Dubbing 96

On-screen display

Setup Display 97

Sub-menu 11

System Menu 10

TOOLS menu 11

“Options” setup 106

Original 40, 124

ORIGINAL/PLAYLIST 40,
58

“OSD” language 22, 106

P

“Parental” 107

Parental Control 38

PBC 38

PDC 52, 80

“Picture Control” 101

Playable discs 32

Playback 34, 70

MP3 audio tracks 42

Repeat play 37

Resume Play 38

Slow-motion play 36

Playlist 40, 64, 124

“Present Time” 100

Programme Dubbing 89

“Progressive” 102

Progressive format 124

“Protect” 60

Q

Quick Timer 49, 77

R

Rear panel 122

REC 49, 77

REC MODE 49

Recording 47, 76

recordable discs 30

recording format 30

recording mode 47

tape speed 76

while watching another

programme

49, 77

Recording mode 47

Recording time 47, 50, 76

Region code 33

Remaining time 78

Remote 19, 119

REPEAT 37

Repeat A-B Play 38

Resetting 108

Resume Play 38

“RGB” 23, 101

Rotate 44

S

S VIDEO 14

Safety tab 76

“Scan Audio” 38, 104

Searching

“Chapter” 40

“End Search” 73

“Go To Zero” 73

Inrto Scan 73

Time Search 40

“Title” 40

“Track” 40

Settings 97

Setup Display 97

SP mode 76

Sub-menu 11

Subtitle 35, 106

Surround 36

Synchro Rec 54, 82, 106

System Menu 10

T

“Tape Length” 105

Tape speed 76

TIME/TEXT 46

TIMER 51, 79

Timer List 55, 84

Timer recording 50, 79

change/cancel 55, 84

Manual setting 50, 79

VIDEO Plus+ 52, 81

Title 40, 124

Title List 39, 59

“Title Name” 60, 66

TOOLS 11

TOP MENU 34

Track 40, 124

Tracking 71

Troubleshooting 109

Tuner Preset 22

“Tuner Preset” setup 98

“TV Type” 101

TV/DVD·VIDEO switch 20

TV/VIDEO 20, 49, 77

U

“Unfinalize” 92

Unrecordable pictures 48

V

“VCR Function” 105

“Video” 23, 101

VIDEO CD 32

Video mode 30

VIDEO Plus+ 52, 81

“Video” setup 101

VR mode 30

Z

ZOOM 35

Zoom 44

