

**GREAT SOUND MADE EASY**

# GIGRAC

**GIGRAC**  
*1000<sup>st</sup>*   
PROFESSIONAL POWERED MIXER

**User Guide**



---

**IMPORTANT**  
**Please read this manual carefully before using**  
**your GigRac1000st for the first time.**

---

© Harman International Industries Ltd. 2004

All rights reserved

Parts of the design of this product may be protected by worldwide patents.

Part No. ZM0301-01

Issue: 1

Soundcraft is a trading division of Harman International Industries Ltd. Information in this manual is subject to change without notice and does not represent a commitment on the part of the vendor. Soundcraft shall not be liable for any loss or damage whatsoever arising from the use of information or any error contained in this manual.

No part of this manual may be reproduced, stored in a retrieval system, or transmitted, in any form or by any means, electronic, electrical, mechanical, optical, chemical, including photocopying and recording, for any purpose without the express written permission of Soundcraft.



Harman International Industries Limited  
Cranborne House  
Cranborne Road  
POTTERS BAR  
Hertfordshire  
EN6 3JN  
UK

Tel: +44 (0)1707 665000

Fax: +44 (0)1707 660742

<http://www.soundcraft.com>



This equipment complies  
with the EMC directive  
89/336/EEC  
Modified by  
92/31/EEC  
93/68/EEC  
91/263/EEC  
and LVD 73/23/EEC  
modified by 93/68/EEC

**This product is approved to  
safety standards:**

IEC 60065: 2001  
EN60065:2002  
UL6500 7th Edition: 2003  
CAN/CSA-E60065-00

And EMC standards  
EN55103-1: 1996 (E2)  
EN55103-2: 1996 (E2)

**For further details contact:**

Harman International Industries Ltd.  
Cranborne House, Cranborne Road  
Potters Bar, Hertfordshire, EN6 3JN, UK

Tel: +44 (0) 1707 665000  
Fax: +44 (0) 1707 660742  
e-mail: [info@soundcraft.com](mailto:info@soundcraft.com)

# CONTENTS

<b>IMPORTANT SAFETY INSTRUCTIONS .....</b>	<b>4</b>
<b>Introduction .....</b>	<b>7</b>
<b>Quick Start Guide .....</b>	<b>8</b>
<b>Quick Start Guide Key .....</b>	<b>9</b>
<b>A Note on Channel Use .....</b>	<b>14</b>
<b>Front Panel .....</b>	<b>15</b>
<b>Master Section .....</b>	<b>18</b>
<b>Rear Panel .....</b>	<b>24</b>
<b>Rackmounting Your GigRac .....</b>	<b>26</b>
<b>Using your GigMat .....</b>	<b>27</b>
<b>Connectors and Leads .....</b>	<b>28</b>
<b>Block Diagram .....</b>	<b>29</b>
<b>Warranty .....</b>	<b>30</b>
<b>Specifications .....</b>	<b>31</b>

NOTE: This equipment has been tested and found to comply with the limits for a Class A digital device, pursuant to Part 15 of the FCC Rules. These limits are designed to provide reasonable protection against harmful interference when the equipment is operated in a commercial environment. This equipment generates, uses, and can radiate radio frequency energy and, if not installed and used in accordance with the instruction manual, may cause harmful interference to radio communications. Operation of this equipment in a residential area is likely to cause harmful interference in which case the user will be required to correct the interference at his/her own expense.

# IMPORTANT SAFETY INSTRUCTIONS

## CAUTIONS

- To avoid the risk of fire, replace the mains fuse only with the correct type and value fuse, as marked on the rear of the product.
- **ATTENTION:** - Afin de réduire le risque de feu remplacer seulement avec fusible de même type.

- **MAINS VOLTAGE SELECTION**

This setting is NOT User Adjustable.

The units are capable of operating at either 230V AC or 115V AC mains voltages  $\pm 10\%$ .

- **REPLACING MAINS FUSE**

Remove the mains lead from the connector. Use a small screwdriver to unscrew the fuse carrier from its location to the left of the mains power connector. Check the fuse is of the correct type and value and replace if necessary; also check that the voltage rating as marked on the rear panel is correct for the mains supply level before switching the unit ON again.

If the mains fuse fails repeatedly this may be because an electrical safety hazard exists. The unit must be taken out of service and referred to the Soundcraft dealer from where the equipment was purchased.

- **THIS UNIT MUST BE EARTHED**

Under no circumstances should the mains earth be disconnected from the mains lead.

- **ATTENTION:** - Cet appareil doit être branché à la terre.

The wires in the mains lead are coloured in accordance with the following code:

	UK & EU	US & CAN
Earth / Ground:	Green and Yellow	Green and Yellow
Neutral:	Blue	White
Live:	Brown	Black

As the colours of the wires in the mains lead may not correspond with the coloured markings identifying the terminals in your plug, proceed as follows:

The wire which is coloured Green and Yellow must be connected to the terminal in the plug which is marked with the letter E or by the earth / ground symbol: 

The wire which is coloured Blue or White must be connected to the terminal in the plug which is marked with the letter N.

The wire which is coloured Brown or Black must be connected to the terminal in the plug which is marked with the letter L.

Ensure that these colour codings are followed carefully in the event of the plug being changed.

Replacement Part No: FJ8016 (UK) : FJ8017 (EU) : FJ8018 (US & CAN)

- Do not install near any heat sources such as radiators, heat resistors, stoves, or other apparatus (including amplifiers) that produce heat.
- Do not use this apparatus near water. The apparatus must not be exposed to dripping or splashing. Objects containing liquid must not be placed on the apparatus.
- The disconnect device is the mains plug or the appliance connector: either one must remain accessible so as to be readily operable in use.
- Do not defeat the safety purpose of the polarized or grounding type plug.

A polarized plug has two blades with one wider than the other. A grounding type plug has two blades and a third grounding prong. The wide blade or the third prong are provided for your safety. When the provided plug does not fit into your outlet, consult an electrician for replacement of the obsolete outlet.

- Protect the power cord from being walked on or pinched particularly at plugs and convenience receptacles.
- Only use cables and hardware specified by the manufacturer.

- Unplug this apparatus during lightning storms or when unused for long periods of time.
- Refer all servicing to qualified service personnel. Servicing is required when the apparatus has been damaged in any way such as, liquid has been spilled or objects have fallen into the apparatus, the apparatus has been exposed to rain or moisture, the apparatus does not operate normally or has been dropped.
- If the power cord is damaged obtain a replacement from your Soundcraft dealer.
- It is recommended that all maintenance and service on the product should be carried out by Soundcraft or its authorised agents. Soundcraft cannot accept any liability whatsoever for any loss or damage caused by service, maintenance or repair by unauthorised personnel.
- If a trolley is used, use caution when moving the trolley / apparatus combination to avoid injury from tip-over.

## **WARNINGS**

- Read these instructions.
- Keep these instructions.
- Heed all warnings.
- Follow all instructions.
- This unit contains no user serviceable parts. Refer all servicing to a qualified service engineer, through the appropriate Soundcraft dealer.
- Clean the apparatus only with a dry cloth.
- DO NOT block any of the ventilation openings. DO NOT install where air cannot flow over the rear of the unit. DO Install in accordance with the manufacturers instructions.

# Introduction

Firstly we'd like to thank you for choosing the Soundcraft GigRac 1000st. We hope you have many happy years together!

## Features

- 8 Microphone Inputs
- 48V Phantom Power for condenser microphones (Inputs 1-4 only)
- PAD buttons for controlling loud input signals (Inputs 1-4 only)
- 4 Stereo inputs
- Treble, Mid and Bass controls
- Pan/Bal controls
- Individual volume controls on each channel for Monitor level.
- Individual volume controls on each channel for Main level.
- Individual send controls for GiGFX on each channel
- 2 x 7 Band Graphic Equaliser
- 10 x Digital Effects (24 Bit/48 kHz)
- Record Output
- Playback Input
- FX bypass switch
- FX bus output socket
- Submix input
- 2 x Amplifier 'Clip' warning lights
- 2 x 10 segment LED output level meters

## The GigRac case.

Your GigRac is cased in a structural foam copolymer polypropylene resin, which gives an optimum combination of strength and impact resistance. This material also helps to keep the shell in good condition as it very resistant to dents and scratches.

The nature of the moulding process leaves the irregular streaky surface finish that gives the GigRac its tough and unique look.

## Amplifier Power Ratings

### GigRac 1000st

2 x 500W @ 4 Ohms.

2 x 300W @ 8 Ohms.

# Quick Start Guide

If like most people you can't wait to use your GigRac for the first time, then use the Quick Start Guide to get things started. The Quick Start Guide covers the following:

- 1. Connecting up your loudspeakers to the GigRac**
- 2. Plugging in a vocal microphone**
- 3. Adding Treble, Mid or Bass to the signals**
- 4. Plugging in a guitar or stereo keyboard**
- 5. Apply one of the 10 GigFX digital effects to the signals**

---

**Note: We recommend that you read through the entire GigRac user guide to familiarise yourself with all of the features on offer.**

---



# Quick Start Guide Key

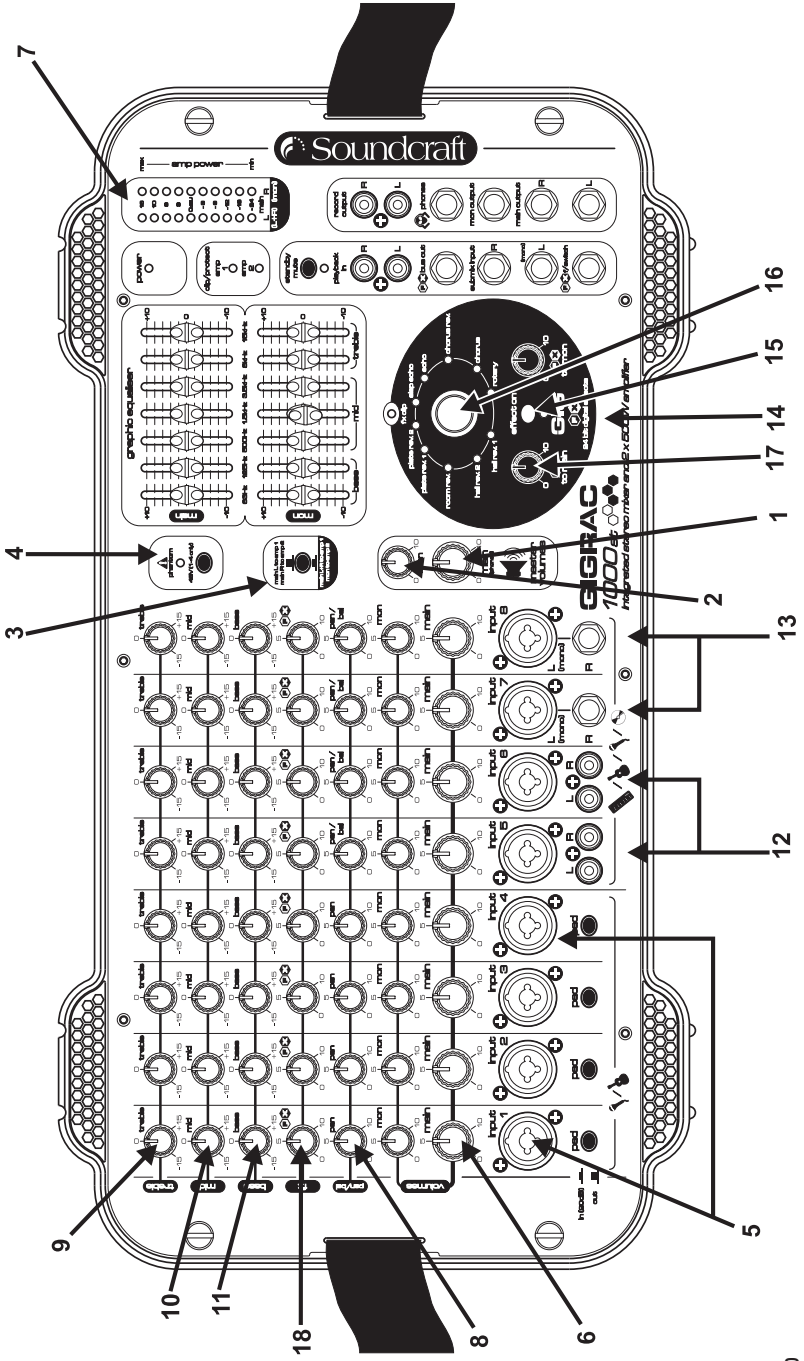

## 1. Connecting up your loudspeakers to the GigRac

---

**Note: Make sure your GigRac is not powered up. This is very important to prevent any damage to either the GigRac or your loudspeakers!**

---

Using good quality speaker cables connect the loudspeakers to the Speaker outputs on the rear of the GigRac.

If you have cables equipped with Neutrik Speakon® connectors then use the Speakon® connectors on the rear of the GigRac. Alternatively if you have cables equipped with jack plugs then use the jack sockets on the rear of the GigRac.

Make sure that the Main Master Volume control **(1** - see the key on page 9) and the Monitor (Mon) Master Volume control **(2)** are turned fully down.

Decide if you want to configure the 2 internal amplifiers to work as a stereo pair, or mono mix and monitor. Set the amplifier source select switch **(3)** as desired. It is assumed in these quick start instructions that you have configured the amps as a stereo pair.

Now switch the GigRac on using the Power switch on the rear of the unit.

## 2. Plugging in a vocal microphone

---

**Note: Before connecting a microphone to channels 1-4, make sure that the 48V phantom power switch (4) is switched off (The red LED should not be illuminated).**

---

Connect the microphone cable to one of the first four inputs on the front of the GigRac **(5)**.

(The inputs on the GigRac can receive either 3-Pin XLR or standard Jack connectors.)

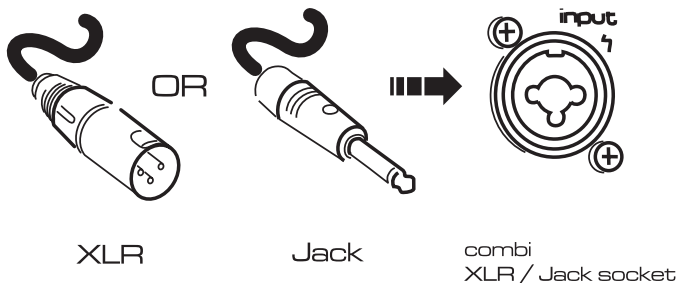

Turn the Main Master Volume control **(1)** up to about half-way.

Now gradually turn up the Main Volume control **(6)** on the microphone channel you have chosen to use. You should now hear the microphone signal appearing in the loudspeakers as you begin to speak.

You should also be able to see activity on the Output Meter **(7)**.

Assuming that you have configured the amps as a stereo pair, you can pan the microphone signal from left to right using the Pan control **(8)**.

---

**Note: The XLR input on channels 1 - 4 is very sensitive. Depending on your microphone or your application, you may need to press the PAD button to prevent distortion occurring; don't worry, this is perfectly normal.**

---

---

**Note: Be careful not to point the microphone at the loudspeakers or you could accidentally create unpleasant feedback sounds.**

---

## A note on Condenser Microphones

If your microphone is a condenser microphone that requires phantom power you will need to switch on the 48V phantom power switch **(4)** located to the left of the Graphic Equaliser. Before doing this make sure that the Main Volume control **(6)** on the chosen channel is turned fully off to avoid causing an unpleasant sound that might damage your speakers.

### **3. Adding Treble, Mid or Bass to the signal**

The GigRac offers Treble, Mid and Bass control for changing the tone of the signal.

#### **Treble (9)**

To add or remove some brightness or 'sparkle' to or from a signal, use the Treble control. In the center 'click' position (0) the Treble control has no effect. Turning it clockwise will boost the treble frequencies making the signal sound brighter. Turning it anti-clockwise will have the opposite effect by removing the treble frequencies and making the signal sound less bright.

The Treble control is handy for adding some sparkle for example to an acoustic guitar, or for reducing the 's' sound from sibilant vocals.

#### **Mid (10)**

Short for 'Midrange' this knob can be used to cut or boost important fundamental frequencies. In the centre 'Click' position the Mid control has no effect. Turning it clockwise will boost the mid frequencies adding 'body' to signals. This is particularly effective on snare drums and percussive instruments. Turning it anti-clockwise will have the opposite effect and is useful for removing 'boxy' resonant frequencies from acoustic guitars and other signals.

#### **Bass (11)**

To add some 'bass thump' to a signal or remove some 'boominess' or rumble, use the Bass control. In the center 'click' position (0) the Bass control has no effect. Turning it clockwise will boost the Bass frequencies making the signal sound punchier and more 'bassy'. Turning it anti-clockwise will have the opposite effect by removing the bass frequencies and making the signal sound less 'boomy'.

The Bass control is useful for making a bass drum sound punchier, or alternatively could be used for reducing explosive 'b' and 'p' sounds from a vocal signal.

## 4. Plugging in an Acoustic Guitar, Stereo Keyboard or CD Player

The GigRac will happily receive signals from instruments with either mono or stereo outputs such as guitars (Mono) or stereo keyboards and CD Players (Stereo).

Before plugging in, make sure the Main Volume control **(6)** for the chosen channel is turned fully off to avoid accidental damage to your speakers.

### Acoustic Guitars

Set the Main Master Volume control **(1)** to about halfway.

Make sure the Main Volume control **(6)** on the channel you are about to use is turned fully down.

Plug the guitar lead into the jack socket in the center of the combination input socket **(5)** on the channel of your choice. Turn up the volume control on your guitar to about halfway, and then gradually turn up the Main Volume control **(6)** until you hear the guitar signal appearing in the loudspeakers. You should also see activity on the Main Output meter **(7)**.

### Stereo Keyboards and CD Players

The GigRac offers four channels that can receive stereo inputs. Two of these channels are equipped with RCA/Phono connectors (Channel 5 and 6) **(12)** and two with Jack connectors (Channels 7 and 8) **(13)**.

Connect up the Left and Right outputs of your CD player or Cassette deck to the Left and Right RCA/Phono inputs on either Channel 5 or 6 of the GigRac. Turn up the Main Master Volume control **(1)** to about halfway, and then turn up the Main Volume control **(6)** on the chosen channel until you hear the signal appearing in the loudspeakers.

Connect up the Left and Right outputs of your Stereo Keyboard to the Left and Right Jack inputs on either Channel 7 or 8 of the GigRac. Set the volume control of your keyboard to about halfway. Turn up the Main Master Volume control **(1)** to about halfway, and then turn up the Main Volume control **(6)** on the chosen channel until you hear the signal appearing in the loudspeakers.

You may now use the Treble, Mid and Bass controls as mentioned above to change the tone of the signals.

## 5. Apply one of the 10 GigFX digital effects to the signals

The GigRac's GIGFX Processor **(14)** has a choice of 10 studio quality digital effects that can be added to any individual or group of signals running through the mixer. Usually vocals require some digital reverb or echo to be added to them in order to create a more spatial sound that is pleasing to the listener.

Make sure the 'effects On' button **(15)** is selected.

To try this out simply select one of the 10 GigFX presets, such as Hall Reverb, using the selector knob **(16)**.

Turn the 'FX to Main' control **(17)** to about halfway and then gradually turn up the individual 'FX' send control **(18)** on the channel you wish to add the effect to. As you turn up the 'FX' send level you should hear the signal change.

By pressing the 'effects On' **(15)** switch to the off position you can compare the original 'dry' signal with the 'wet' effect signal.

You can now turn the selector knob **(16)** to select different types of effects for comparative purposes.

## A Note on Channel Use



Channels 1-4 are the most sensitive. It is better to use these channels for microphones (particularly if your microphones are fitted with jack plugs), and guitars with passive pickups. It is likely that you will need to have the pad buttons pressed in if you use mics fitted with XLRs.



Channels 5-8 are less sensitive, they are ideal for line-level devices such as keyboards, CD players and tape players. They will also work with guitars with active pickups. Microphones fitted with XLRs will also work (unless they need phantom power).

# Front Panel

## Input channel

The GigRac 1000st has a total of 8 channels. Channels 1-4 are designed to handle mono microphone or mono line level signals only. Channels 5-8 are designed to handle mono microphone and stereo line level signals but will also accommodate mono line-level signals as well.

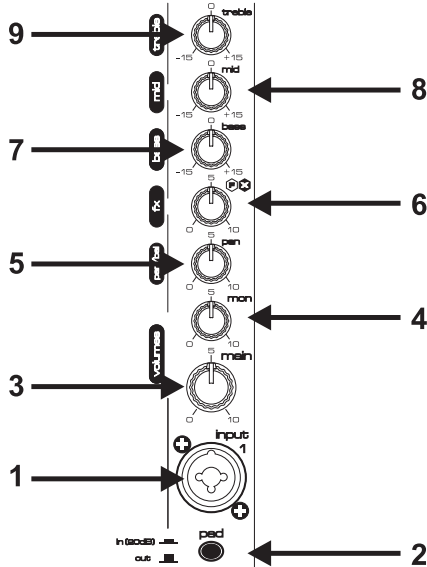

### (1) Input Connector

This connector is a combination Jack/3 Pin XLR connector and can receive any of the following types of input connectors:

- Microphone cables with Jack connectors
- Microphone cables with 3 pin XLR connectors
- Line input cables with Jack connectors (e.g. guitars, keyboards etc.)
- Line input cables with 3 pin XLR connectors.

## **(2) PAD switch (Channels 1-4 only)**

Pressing the PAD switch reduces the input level by 20dB allowing line or mic level signals that would normally be too loud for the Input stage to handle to be connected without any audible distortion.

## **(3) Main Volume Control**

The Main Volume Control determines the amount of level sent from the channel to the main output mix.

This allows each channel's relative volume level to be 'blended' together to create the final mix whose overall level is then controlled by the Main Master Volume control **(10 - see the master section)**.

## **(4) Mon Volume Control**

The Monitor (Mon) Volume Control determines the amount of level sent from the channel to the Monitor (Mon) Output **(23)**.

This allows each channel's relative volume level to be 'blended' together to create a separate monitor mix whose overall level is then controlled by the Mon Master Volume control **(11 - see the master section)**. This feature is used mainly for creating a 'foldback' mix for the musicians and would normally be sent to a monitor speaker with its own amplifier. (This could also be used for creating a headphone mix).

The Mon Volume Control operates independent of the Main Volume Control and will therefore not be affected if the Main Volume Control is turned up or down. (For the more technically minded, the signal is sourced Pre-Fader and Post EQ, see the block diagram for signal routing details.)

## **(5) PAN/Balance Control**

This allows you to position the signal within the stereo image or, in the case of stereo signals, to balance the level of the signals between the L and R speakers.

## **(6) FX Control**

The FX Control determines the amount of level sent from the channel to the GigFX digital effects processor and also to the 'FX Bus output' connector **(24)**.

This allows each channel's relative level to be 'blended' together to create a separate effects mix whose overall level is then controlled by the 'FX to Main' **(28 - see the master section)** and 'FX to Mon' **(29)**.



The FX Bus Output connector could also be used to connect to other external devices such as effects processors or recorders.

## **(7) Bass Control**

The Bass Control is set at 80Hz and allows you to either add or remove the low frequency content of the signal by 15dB.

Rotating the control clockwise will 'boost' the signal, rotating the control anticlockwise will 'cut' the signal.

This control is useful for adding more 'thump' to low frequency signals such as bass guitars and kick drums but can also be used to remove unwanted rumble or boominess from signals such as vocal or instrument microphones.

## **(8) Mid Control**

The Mid Control is set at 600Hz and allows you to either add or remove the high frequency content of the signal by 15dB.

Rotating the control clockwise will 'boost' the signal, rotating the control anticlockwise will 'cut' the signal.

This control is useful for adding 'body' to drums, bass guitars or percussion but can also be used to remove 'boxy' resonant frequencies from acoustic guitars and other signals.

## **(9) Treble Control**

The Treble Control is set at 12kHz and allows you to either add or remove the high frequency content of the signal by 15dB.

Rotating the control clockwise will 'boost' the signal, rotating the control anticlockwise will 'cut' the signal.

This control is useful for adding 'crispness' or 'sizzle' to signals with a lot of high frequency content such as guitars and cymbals but can also be used to remove unwanted sibilance from signals such as vocals.



## **(10) Main Master Volume Control**

This control determines the overall level that is sent to the internal amplification and to the Main Output sockets **(22)**. It also controls the volume of the headphone socket **(21)**.

## **(11) Mon Master Volume Control**

This control determines the overall level that is sent to the Monitor Output (Mon Output) socket **(23)**.

## **(12) Phantom 48V Switch**

This switch turns the 48v phantom power On/Off for the 3 pin XLR sockets on channels 1-4. When the switch is turned On the red LED will illuminate.

48V phantom power is used to power condenser microphones and DI boxes.

---

**NB! To avoid possible damage to your loudspeakers, make sure that the Main and Monitor Master Volume controls are turned down fully before switching on the 48V phantom power.**

---

## **(13) Graphic Equalisers**

The Graphic Equalisers are divided into 7 frequency bands. Each frequency band can be used to either 'cut' or 'boost' the Main Output signal by up to 10dB. One is in the main (stereo) path, the other is in the monitor path.

They are very useful for compensating for poor room acoustics or improving the performance of your loudspeakers.

## **(14) Power LED**

The red Power LED illuminates when the GigRac is switched on.

## **(15) Amp Clip LEDs**

The red Amp Clip LEDs illuminate when the input levels to the internal amplifiers are too high. It is acceptable for these LEDs to come on momentarily every now and then but the Main or Monitor Master Volume (depending on which signals have been routed to the amplifiers: see **(16)** below) should be turned down if the Amp Clip LEDs illuminate consistently.

---

**NB! Continued use of the GigRac with the Amp Clip LED illuminated could cause serious damage to your GigRac and your loudspeakers!**

---

## **(16) Internal Amplifier Source Select Switch**

This switch determines which signals are routed to the internal power amplifiers. The options are: Main L to amp 1, and Main R to amp 2, or, Main L + R to amp1, and monitor to amp 2. See the diagram opposite.

## **(17) Main Output Meters**

The dual 10-segment output meters show the signal levels being fed to the internal power amplifiers. See **(16)** above.

It is best to aim to have the red 10dB LEDs lighting up regularly during the loudest signals peaks playing through your GigRac and the 16dB LEDs flicking on very occasionally. This will ensure that a good level is passing through the mixer.

## **(18) Record Outputs**

The Record Outputs (L & R) are for connecting a recording device such as a cassette or mini disk recorder.

The signal output at the Record Output sockets is a post fade signal derived from the Main Mix outputs. The amount of signal level leaving the GigRac via the Record Outputs is determined by the Main Master Volume control **(10)**.

## **(19) Playback In**

The Playback In connectors allow you to playback from your recording device through the Main outputs/Speakers/Headphones. A useful tip is to press the standby mute switch **(20)**, this mutes all other inputs to

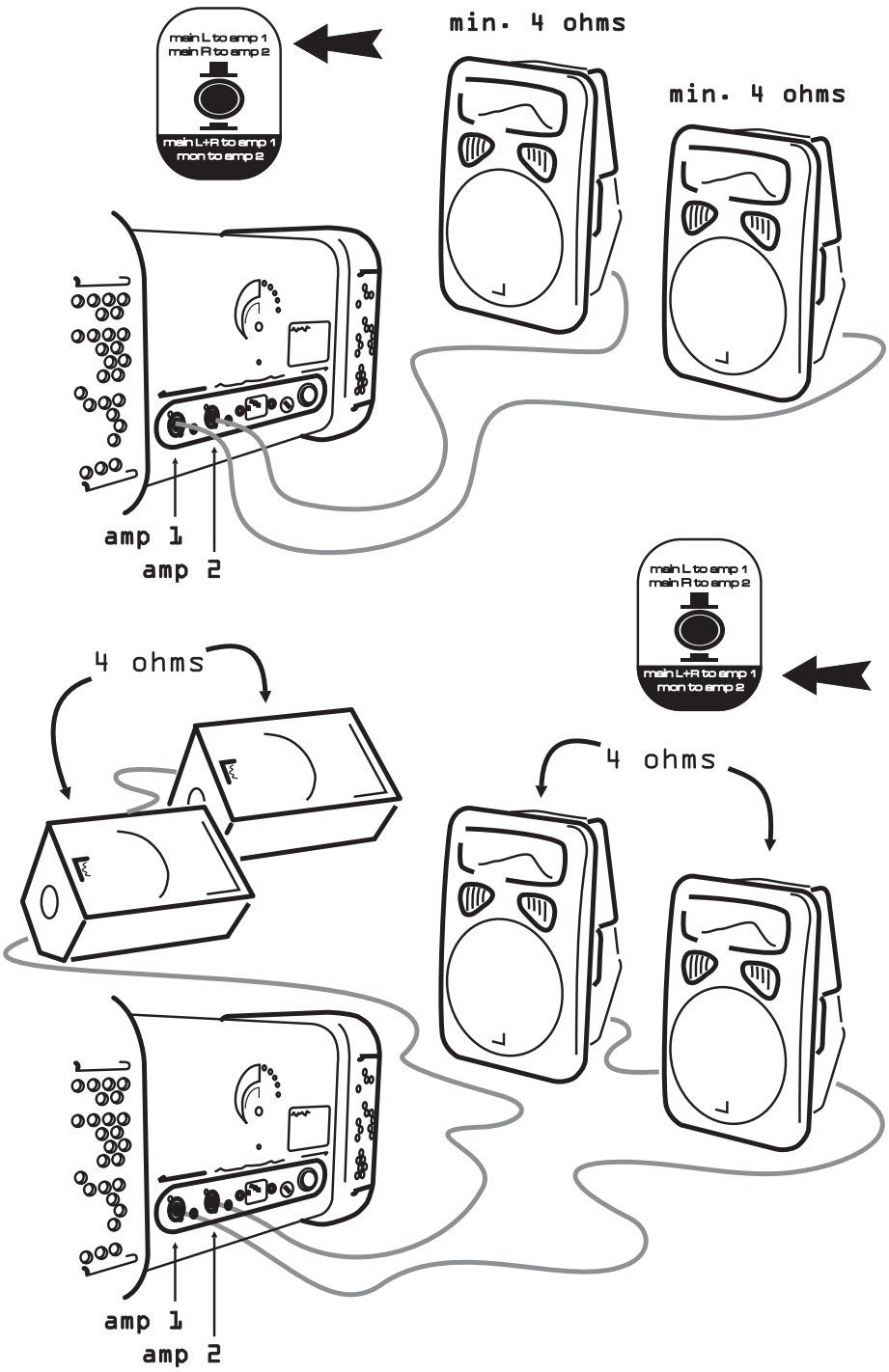

the GigRac and allows the playback in signal to be heard without interference from other signal sources.

## **(20) Standby Mute Switch**

This switch mutes all inputs to the GigRac except for the signal from the playback in connectors. It also mutes the FX Bus Output and the Monitor Output. The red LED illuminates when the mute is active. See the block diagram for signal routing details.

## **(21) Phones Output**

Connect headphones to the Phones Output. The Phones Output is driven from the main L and R signals. The overall volume of the headphones output is determined by using the Main (Phones) Master Volume control **(10)**.

## **(22) Main Outputs**

The Main Outputs carry the Main Mix L and R signals after they have passed through the Main Master Volume control and the Graphic Equaliser. These outputs can be used to send the Main Mix to other amplifiers or powered speakers or alternatively it can be used to send a 'submix' to another mixer's input channel or another recording device.

## **(23) Mon Output**

The Mon Output carries the Monitor Mix signal derived from the Mon controls on each channel. The Mon output level is controlled by the Mon Master Volume control **(11)**. The signal also passes through the Monitor Graphic Equaliser. This output is used mainly to send the Mon Mix signal to an on stage fold back speaker system of some kind.

## **(24) FX Bus Output**

The FX Bus Output carries the FX Mix signal as derived from the FX controls on each channel. This allows additional external effects processing devices to be used in conjunction with the GigRac's built in GigFX digital effects processor.

## **(25) Submix Inputs**

The Submix Inputs (L & R) allow the output from another mixer to be blended with the Main Mix Outputs of the GigRac. These inputs could also be used for connecting an effects return signal from an external effects processing device.

## **(26) FX Bypass Footswitch**

The FX Bypass Footswitch socket is used for connecting an optional foot switch to turn the GigFX processor On and Off.

## **(27) Effect on switch**

The effect on switch has a toggle action, the adjacent LED indicates when the FX unit is on.

## **(28) FX to Main Control**

This controls the volume of Effects sent to the main mix.

## **(29) FX to Mon Control**

This controls the volume of Effects sent to the monitor mix.

## **(30) FX Clip LED**

This illuminates when the signal level being fed to the GigFX processor is too high.

# Rear Panel

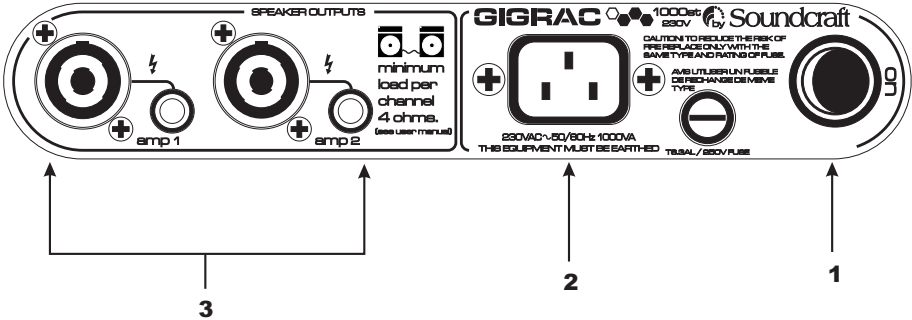

## (1) Power Switch

This switch turns the GigRac On or Off. The red Power LED **(14)** on the front panel will illuminate to confirm this.

---

**NB! Before switching the GigRac On or Off, make sure that the Main and Mon Master Volume controls are turned fully down.**

---

## (2) Power Socket

Connect the supplied power cable to this socket.

## (3) Speakers Outputs (Amp 1 and Amp 2)

The Speaker Outputs are available as Neutrik Speakon® connectors and standard ¼" Jack connectors.

The minimum load that either of the amplifiers inside the GigRac 1000st should be presented with is 4 ohms. this means that a single 4 or 8 ohm speaker can be connected to each amplifier outputs as shown in Fig 1. Alternatively, two 8 ohm speakers can be connected in parallel to each amplifier output, as shown in Fig 2. Two speakers connected like this gives a combined load of 4 ohms.

Use the appropriate connector type to match the input connectors on your loudspeakers. The GigRac 1000st is designed to work with loudspeakers rated at either 8 ohms or 4 ohms.

Connect your loudspeakers to these outputs. The signal sent to the Speakon® connectors and the Jack sockets is exactly the same.



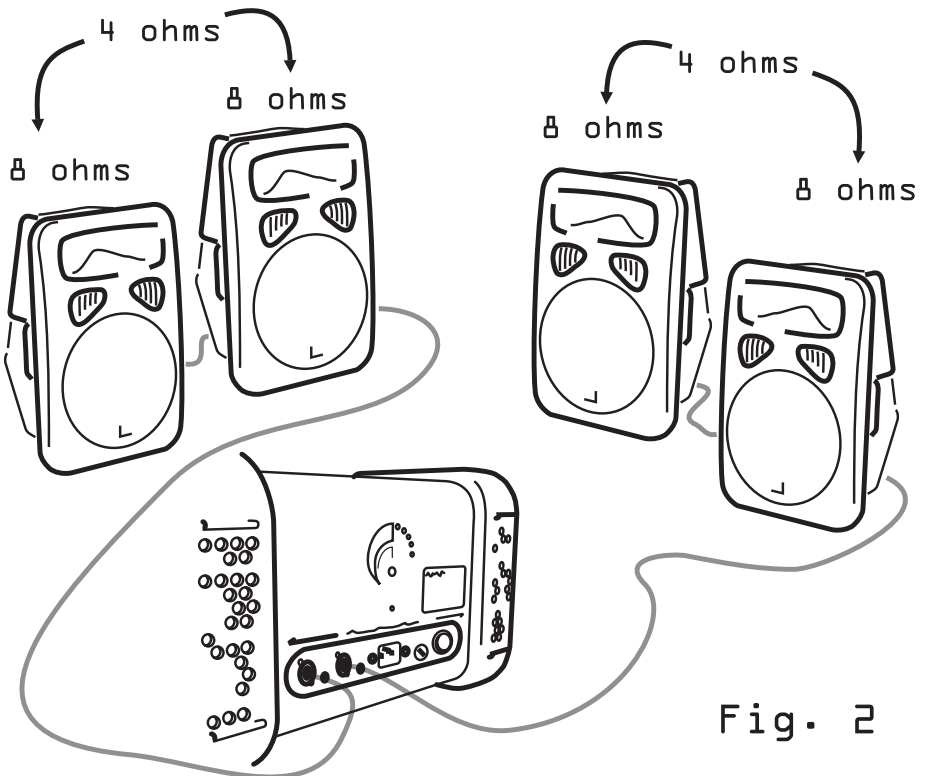
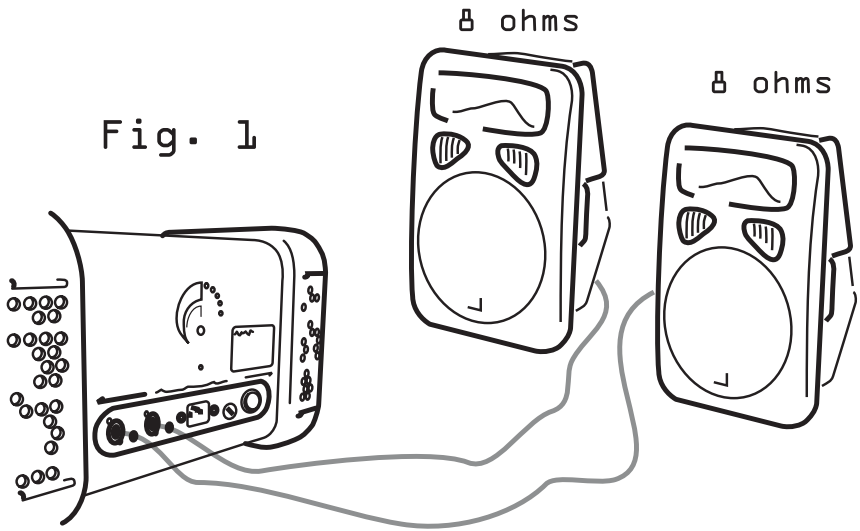

# Rackmounting Your GigRac

The GigRac 1000st can be rack mounted into a standard 19" rack. This is useful for fixed instalations or for applications where the GigRac might need to be installed into a portable 19" rack along with other equipment.

Caution: leave a free 1U space above the Gigrac to allow internal heat to escape.

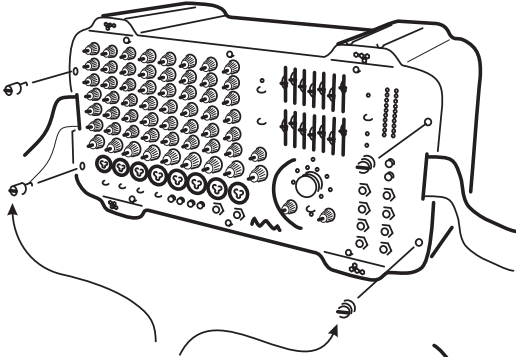

remove 4 rack bolts

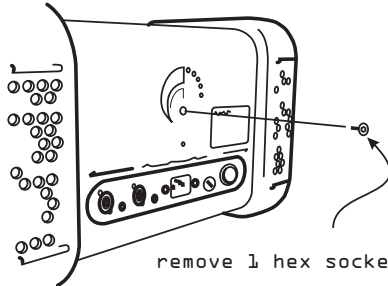

remove 1 hex socket screw

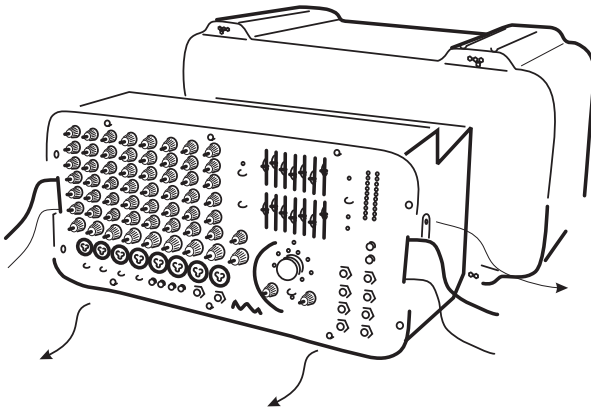

remove gigrac from case.  
Remove 4 screws that secure strap to side panels and remove strap.  
Gigrac is now ready for rack mounting.

## Using your GigMat

GigRac comes supplied with a unique non-slip 'GigMat' which can be placed underneath the GigRac when it has to be put onto a slippery surface such as a shiny table top.

Under normal circumstances the GigMat will prevent the GigRac from slipping around.

If necessary the GigMat can be cleaned using a damp cloth.

---

**Please note - it is very important that the GigMat only be used on level surfaces.**

---

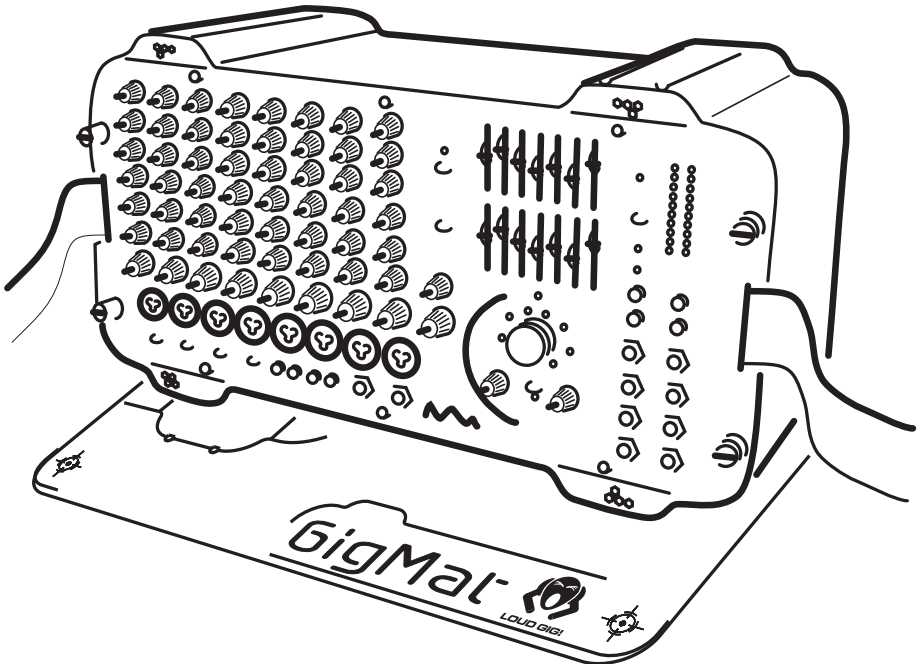

# Connectors and Leads

## Audio Connectors Used With Gigrac



XLR



3-pole 1/4" (A guage TRS) jack



Speakon®



RCA phono



2-pole 1/4" (A guage TS) jack

## Details Of Audio Connecting Leads That You May Wish To Use

### Balanced

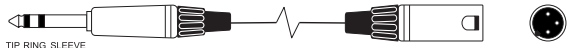
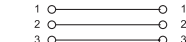
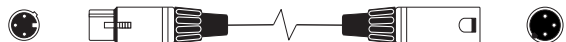
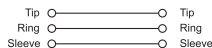
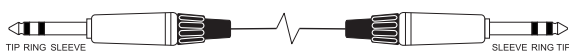

### Unbalanced

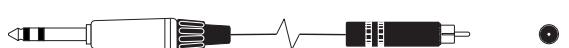
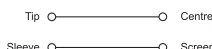
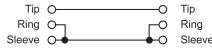
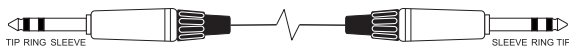
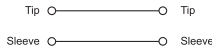
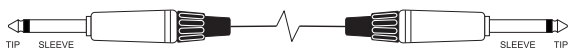
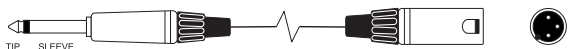

### Headphone Separator

Note: for every doubling of headphones the load impedance is halved. Do not go below 200 ohms (Ω).

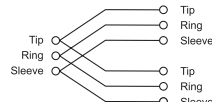
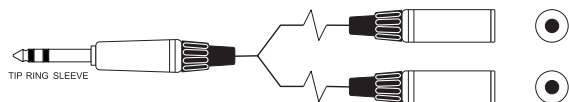

### Speakon® Leads

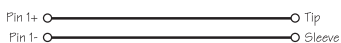
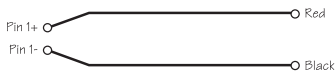

# Block Diagram

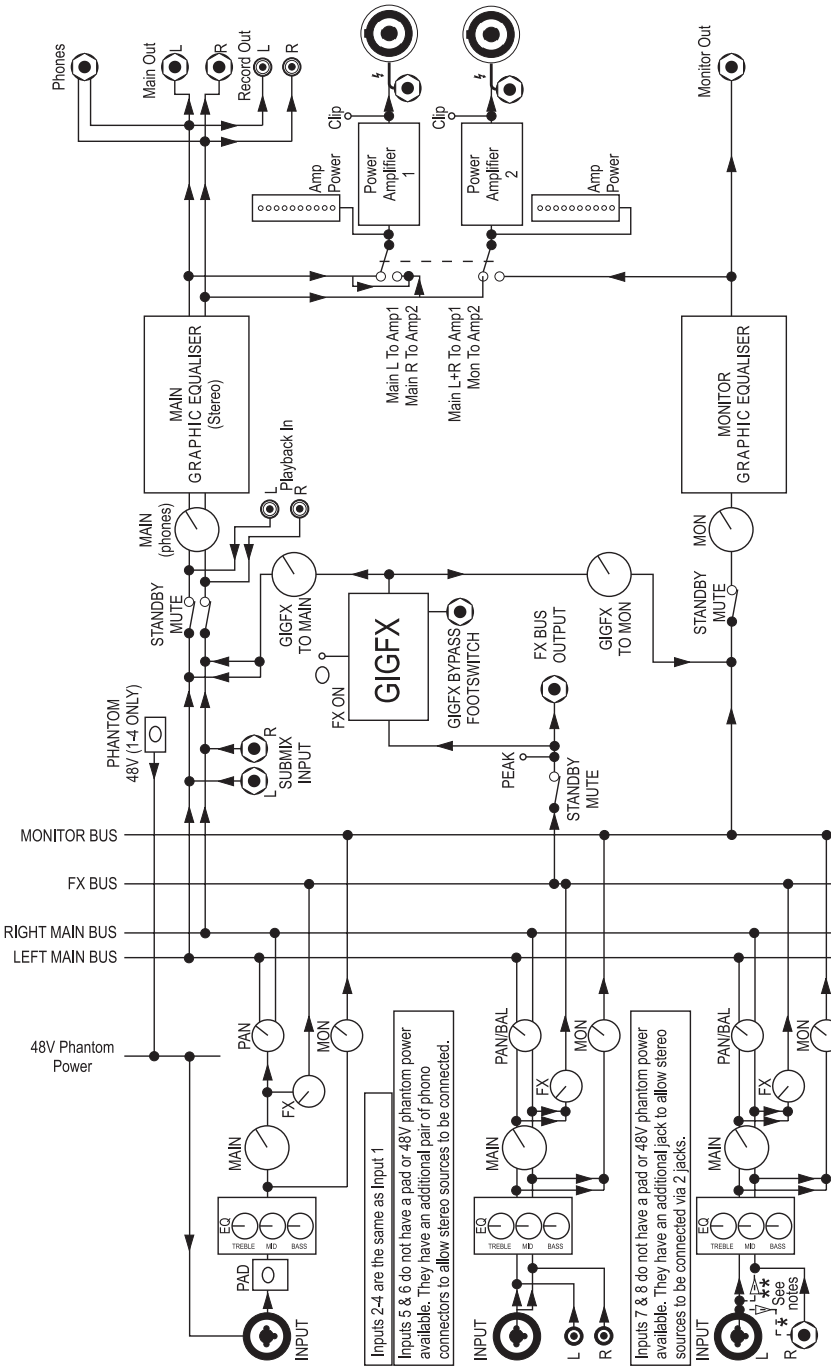

Inputs 2-4 are the same as Input 1  
 Inputs 5 & 6 do not have a pad or 48V phantom power available. They have an additional pair of phono connectors to allow stereo sources to be connected.

Inputs 7 & 8 do not have a pad or 48V phantom power available. They have an additional jack to allow stereo sources to be connected via 2 jacks.

\* There is a normalised connection between the jack part of the combiconnector (L) and the Right jack.  
 \*\* This path is only active if an XLR is plugged in.

# Warranty

- 1 Soundcraft is a trading division of Harman International Industries Ltd. End User means the person who first puts the equipment into regular operation.  
Dealer means the person other than Soundcraft (if any) from whom the End User purchased the Equipment, provided such a person is authorised for this purpose by Soundcraft or its accredited Distributor.  
Equipment means the equipment supplied with this manual.
- 2 If within the period of twelve months from the date of delivery of the Equipment to the End User it shall prove defective by reason only of faulty materials and/or workmanship to such an extent that the effectiveness and/or usability thereof is materially affected the Equipment or the defective component should be returned to the Dealer or to Soundcraft and subject to the following conditions the Dealer or Soundcraft will repair or replace the defective components. Any components replaced will become the property of Soundcraft.
- 3 Any Equipment or component returned will be at the risk of the End User whilst in transit (both to and from the Dealer or Soundcraft) and postage must be prepaid.
- 4 This warranty shall only be valid if:
  - a) the Equipment has been properly installed in accordance with instructions contained in Soundcraft's manual; and
  - b) the End User has notified Soundcraft or the Dealer within 14 days of the defect appearing; and
  - c) no persons other than authorised representatives of Soundcraft or the Dealer have effected any replacement of parts maintenance adjustments or repairs to the Equipment; and
  - d) the End User has used the Equipment only for such purposes as Soundcraft recommends, with only such operating supplies as meet Soundcraft's specifications and otherwise in all respects in accordance with Soundcraft's recommendations.
- 5 Defects arising as a result of the following are not covered by this Warranty: faulty or negligent handling, chemical or electro-chemical or electrical influences, accidental damage, Acts of God, neglect, deficiency in electrical power, air-conditioning or humidity control.
- 6 The benefit of this Warranty may not be assigned by the End User.
- 7 End Users who are consumers should note their rights under this Warranty are in addition to and do not affect any other rights to which they may be entitled against the seller of the Equipment.

# Specifications

## NOISE

EIN 150 ohms 20 - 22kHz	-123 dBu
Main out Level control mid	-78 dBu
Mon out Level control mid	-80 dBu
Amp out	-57 dBu

## CROSSTALK

Main cutoff	-80 dB
Mon cutoff	-80 dB
Frequency Response	
20 - 22Khz rel 1kHz Line in to Main out	+0.2/-2.5 dB

## THD+N

Mic i/p -20dB Pad OdBu I/P at Main out (22Hz-22kHz)	0.15%
Mic i/p to Amp Out @ full power 22-22kHz	0.15%

## INPUTS CH1 - CH4

Mic Input Impedance	5.5 kohms
Line Input Impedance	30 kohms
Max Input Mic ( 20dB pad )	-3.5 dBu
Max Input Line( 20dB pad )	10 dBu
Max Mic gain to main out	60 dB

## INPUTS CH5 - CH8

Mic Input Impedance	2.4 kohms
Line Input Impedance	40 kohms
Max Input Mic	-18 dBu
Max Input Line	3 dBu
Max Mic gain to main out	50 dB

## OUTPUTS

Max out main / mon	18 dBu
Power Output	2 X 500W into 4 Ohms

## CONNECTORS

(All Jacks are 3 - pole ¼")

Mic: Balanced XLR combi connectors/ Balanced jack combi connectors

Line: Balanced Jack / combi connectors / Unbalanced RCA phono

FX bus output: Impedance Balanced Jack

Submix in: Unbalanced Jack

Main out: Impedance Balanced Jack

Mon out: Impedance Balanced Jack

Record out: unbalanced RCA phono

Phones: Jack

Speakers: Speakon (pins +1 and -1) and Jack

## DIMENSIONS (WITH LID ON)

493mm x 267mm x 334mm (19.5" x 10.5" x 13.2")

## WEIGHT

12kg/26.4lbs



**GigRac is designed and engineered in the UK by Soundcraft, world leaders in professional sound.**

 **Soundcraft**

**Soundcraft**

Harman International Industries Ltd

Cranborne House, Cranborne Road, Potters Bar, Herts, EN6 3JN, UK

TEL: +44 (0)1707 665000 FAX: +44 (0)1707 660742 EMAIL: [info@soundcraft.com](mailto:info@soundcraft.com)

**Soundcraft USA**

8500 Balboa Blvd., Northridge, CA 91329, USA

TEL: +1-818-920-3212 FAX: +1-818-920-3208 EMAIL: [soundcraft-usa@harman.com](mailto:soundcraft-usa@harman.com)

**[www.gigrac.com](http://www.gigrac.com)**

Soundcraft reserves the right to improve or otherwise alter any information supplied in this document or any other documentation supplied hereafter. E&OE 06/04. This equipment complies with the EMC Directive 89/336/EEC

**H** A Harman International Company