

TOSHIBA



DVD VIDEO PLAYER

SD-1810

OWNER'S MANUAL



SAFETY PRECAUTIONS

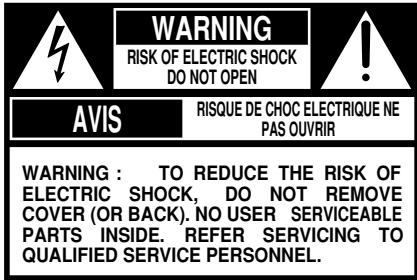

The lightning flash with arrowhead symbol, within an equilateral triangle, is intended to alert the user to the presence of uninsulated "dangerous voltage" within the product's enclosure that may be of sufficient magnitude to constitute a risk of electric shock to persons.



The exclamation point within an equilateral triangle is intended to alert the user to the presence of important operating and maintenance (servicing) instructions in the literature accompanying the appliance.

WARNING: TO REDUCE THE RISK OF FIRE OR ELECTRIC SHOCK, DO NOT EXPOSE THIS APPLIANCE TO RAIN OR MOISTURE. DANGEROUS HIGH VOLTAGES ARE PRESENT INSIDE THE ENCLOSURE. DO NOT OPEN THE CABINET. REFER SERVICING TO QUALIFIED PERSONNEL ONLY.

CAUTION: TO PREVENT ELECTRIC SHOCK, MATCH WIDE BLADE OF PLUG TO WIDE SLOT, FULLY INSERT.

ATTENTION: POUR EVITER LES CHOCS ELECTRIQUES, INTRODUIRE LA LAME LA PLUS LARGE DE LA FICHE DANS LA BORNE CORRESPONDANTE DE LA PRISE ET POUSSER JUSQU'AU FOND.

CAUTION: This Digital Video Disc Player employs a Laser System.
To ensure proper use of this product, please read this owner's manual carefully and retain for future reference. Should the unit require maintenance, contact an authorized service location - see service procedure.

Use of controls or adjustments or performance of procedures other than those specified herein may result in hazardous radiation exposure.

To prevent direct exposure to laser beam, do not try to open the enclosure.
Visible and invisible laser radiation when open and interlocks defeated.
DO NOT STARE INTO BEAM.

FCC NOTICE: This equipment has been tested and found to comply with the limits for a Class B digital device, pursuant to part 15 of the FCC Rule. These limits are designed to provide reasonable protection against harmful interference in a residential installation.

This equipment generates, uses, and can radiate radio frequency energy and, if not installed and used in accordance with the instructions, may cause harmful interference to radio communications.

However, there is no guarantee that interference will not occur in a particular installation. If this equipment does cause harmful interference to radio or television reception, which can be determined by turning the equipment off and on, the user is encouraged to try to correct the interference by one or more of the following measures:

- Reorient or relocate the receiving antenna.
- Increase the separation between the equipment and receiver.
- Connect the equipment into an outlet on a circuit different from that to which the receiver is connected.
- Consult the dealer or an experienced radio/TV technician for help.

WARNING: Changes or modifications made to this equipment, not expressly approved by Toshiba, or parties authorized by Toshiba, could void the user's authority to operate the equipment.

CAUTION: Servicing instructions are for use by qualified service personnel only. To reduce the risk of electric shock do not perform any servicing other than that contained in the operating instructions unless you are qualified to do so.

In the spaces provided below, record the Model and Serial No. located on the rear panel of your DVD video player.

Model No. _____

Serial No. _____

Retain this information for future reference.

Location of the required label

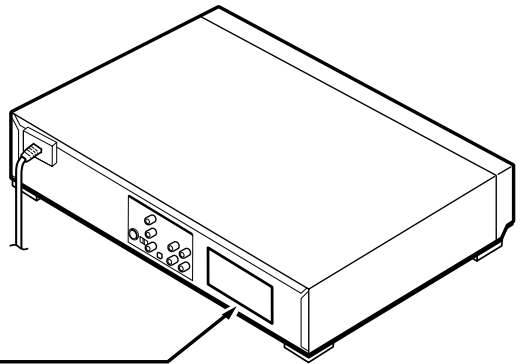

TOSHIBA DVD PLAYER MODEL NO. SD-1810A
TOSHIBA CORPORATION : 1-1, SHIBAURA 1-CHOME, MINATO-KU, TOKYO 105-8001, JAPAN

PRODUCT IS CERTIFIED BY THE MANUFACTURER TO COMPLY WITH DHHS RULE 21 CFR SUBCHAPTER J APPLICABLE AT THE DATE OF MANUFACTURE.	MANUFACTURED/FABRIQUÉA : SERIAL NO./NO. DE SERIE
--	---

IMPORTANT SAFEGUARDS

CAUTION: PLEASE READ AND OBSERVE ALL WARNINGS AND INSTRUCTIONS PROVIDED IN THIS OWNER'S MANUAL AND THOSE MARKED ON THE UNIT. RETAIN THIS BOOKLET FOR FUTURE REFERENCE.

This set has been designed and manufactured to assure personal safety. Improper use can result in electric shock or fire hazard. The safeguards incorporated in this unit will protect you if you observe the following procedures for installation, use and servicing. This unit is fully transistorized and does not contain any parts that can be repaired by the user.

DO NOT REMOVE THE CABINET COVER, OR YOU MAY BE EXPOSED TO DANGEROUS VOLTAGE. REFER SERVICING TO QUALIFIED SERVICE PERSONNEL ONLY.

1. Read these instructions.

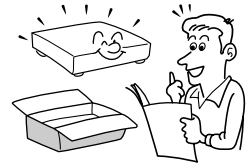

2. Keep these instructions.

3. Heed all warnings.

4. Follow all instructions.

5. Do not use this apparatus near water.

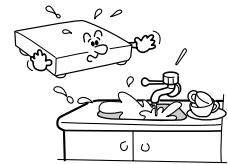

6. Clean only with dry cloth.



7. Do not block any ventilation openings. Install in accordance with the manufacturer's instructions.



8. Do not install near any heat sources such as radiators, heat registers, stoves, or other apparatus (including amplifiers) that produce heat.

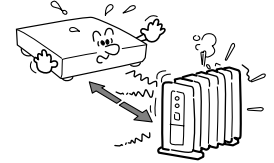

9. Do not defeat the safety purpose of the polarized or grounding-type plug. A polarized plug has two blades with one wider than the other. A grounding type plug has two blades and a third grounding prong. The wide blade or the third prong are provided for your safety. If the provided plug does not fit into your outlet, consult an electrician for replacement of the obsolete outlet.

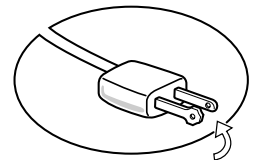

10. Protect the power cord from being walked on or pinched particularly at plugs, convenience receptacles, and the point where they exit from the apparatus.



11. Only use attachments/accessories specified by the manufacturer.

12. Use only with the cart, stand, tripod, bracket, or table specified by the manufacturer, or sold with the apparatus. When a cart is used, use caution when moving the cart/apparatus combination to avoid injury from tip-over.



IMPORTANT SAFEGUARDS

(Continued)

13. Unplug this apparatus during lightning storms or when unused for long periods of time.

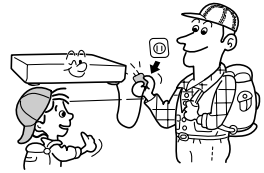

14. Refer all servicing to qualified service personnel. Servicing is required when the apparatus has been damaged in any way, such as power-supply cord or plug is damaged, liquid has been spilled or objects have fallen into the apparatus, the apparatus has been exposed to rain or moisture, does not operate normally, or has been dropped.



15. When you use headphones on the amplifier, keep the volume at a moderate level. If you use the headphones continuously with high volume sound, it may cause hearing damage.



16. Do not overload wall outlets; extension cords, or integral convenience receptacles as this can result in a risk of fire or electric shock.

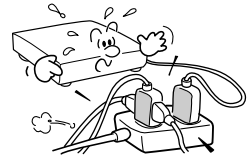

17. Never insert objects of any kind into this apparatus through openings as they may touch dangerous voltage points or short-out parts that could result in a fire or electric shock. Never spill liquid of any kind on the apparatus.



18. Keep your fingers well clear of the disc tray as it is closing. Neglecting to do so may cause serious personal injury.

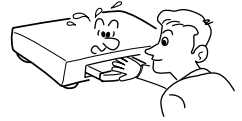

19. Do not place a heavy object on or step on the apparatus. The object may fall, causing serious personal injury and serious damage to the apparatus.

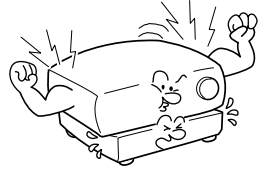

20. Do not use a cracked, deformed, or repaired disc. These discs are easily broken and may cause serious personal injury and apparatus malfunction.



Precautions

Notes on handling

- When shipping the DVD video player, the original shipping carton and packing materials come in handy. For maximum protection, repack the unit as it was originally packed at the factory.
- Do not use volatile liquids, such as insect spray, near the DVD video player. Do not leave rubber or plastic products to contact the DVD video player for prolonged period. They will leave marks on the finish.
- The top and rear panels of the DVD video player may become warm after a long period of use. This is not a malfunction.
- When the DVD video player is not in use, be sure to remove the disc and turn off the power.
- If you do not use the DVD video player for a long period, the unit may not function properly in the future. Turn on and use the DVD video player occasionally.

Notes on locating

- Place the DVD video player on a level surface. Do not use it on a shaky or unstable surface such as a wobbling table or inclined stand. The loaded disc may become dis-aligned and damage the DVD video player.
- When you place this DVD video player near a TV, radio, or VCR, the playback picture may become poor and the sound may be distorted. In this case, place the DVD video player away from the TV, radio, or VCR.

Notes on cleaning

Use a soft, dry cloth for cleaning.

- For stubborn dirt, soak the cloth in a weak detergent solution, wring well and wipe. Use a dry cloth to wipe it dry.
Do not use any type of solvent, such as thinner and benzine, as they may damage the surface of the DVD video player.
- If you use a chemical saturated cloth to clean the unit, follow that product's instructions.

To obtain a clear picture

The DVD video player is a high technology, precision device. If the optical pick-up lens and disc drive parts are dirty or worn down, the picture quality will deteriorate. To obtain a clear picture, we recommend regular inspection and maintenance (cleaning or parts replacement) every 1,000 hours of use depending on the operating environment. For details, contact your nearest dealer.

Notes on moisture condensation

Moisture condensation damages the DVD video player. Please read the following carefully.

Moisture condensation occurs, for example, when you pour a cold drink into a glass on a warm day. Drops of water form on the outside of the glass. In the same way, moisture may condense on the optical pick-up lens inside this unit, one of the most crucial internal parts of the DVD video player.

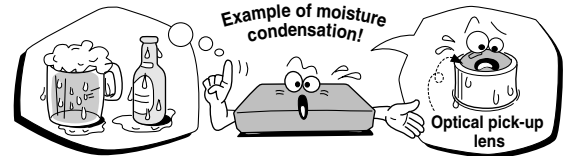

■ **Moisture condensation occurs during the following cases.**

- When you bring the DVD video player directly from a cold place to a warm place.
- When you use the DVD video player in a room where you just turned on the heater, or a place where the cold wind from the air conditioner directly hits the unit.
- In summer, when you use the DVD video player in a hot and humid place just after you move the unit from an air conditioned room.
- When you use the DVD video player in a humid place.

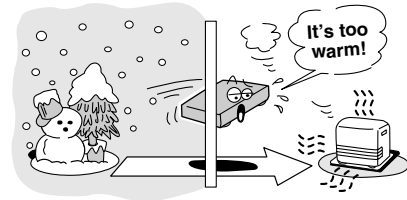

■ **Do not use the DVD video player when moisture condensation may occur.**

If you use the DVD video player in such a situation, it may damage discs and internal parts. Remove the disc, connect the power cord of the DVD video player to the wall outlet, turn on the DVD video player, and leave it for two or three hours. After two or three hours, the DVD video player will have warmed up and evaporated any moisture. Keep the DVD video player connected to the wall outlet and moisture condensation will seldom occur.

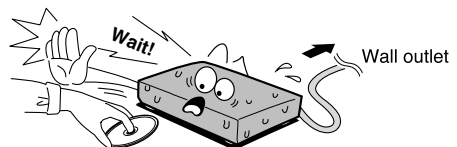

Notes on Discs

On handling discs

- Do not touch the playback side of the disc.

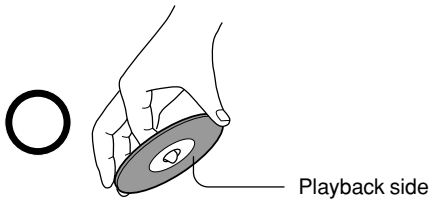

- Do not attach paper or tape to discs.



On cleaning discs

- Fingerprints and dust on the disc cause picture and sound deterioration. Wipe the disc from the center outwards with a soft cloth. Always keep the disc clean.

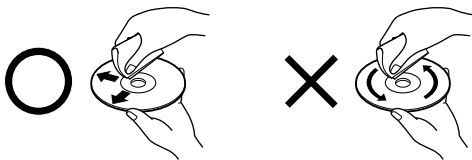

- If you cannot wipe off the dust with a soft cloth, wipe the disc lightly with a slightly moistened soft cloth and finish with a dry cloth.
- Do not use any type of solvent such as thinner, benzene, commercially available cleaners or antistatic spray for vinyl LPs. It may damage the disc.

On storing discs

- Do not store discs in a place subject to direct sunlight or near heat sources.
- Do not store discs in places subject to moisture and dust such as a bathroom or near a humidifier.
- Store discs vertically in a case. Stacking or placing objects on discs outside of their case may cause warping.

Structure of disc contents

Normally, DVD video discs are divided into titles, and the titles are sub-divided into chapters. VIDEO CDs and audio CDs are divided into tracks.

DVD video disc

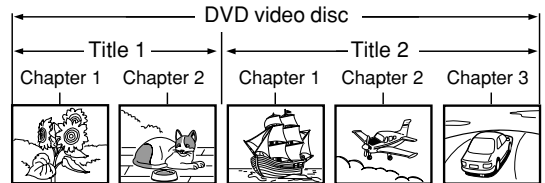

VIDEO CD/audio CD

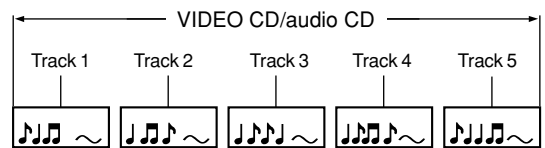

Each title, chapter or track is assigned a number, which is called "title number", "chapter number" or "track number" respectively.

There may be discs that do not have these numbers.

Notes on copyright





It is forbidden by law to copy, broadcast, show, broadcast on cable, play in public, and rent copyrighted material without permission.

DVD video discs are copy protected, and any recordings made from these discs will be distorted.



This product incorporates copyright protection technology that is protected by method claims of certain U.S. patents and other intellectual property rights owned by Macrovision Corporation and other rights owners. Use of this copyright protection technology must be authorized by Macrovision Corporation, and is intended for home and other limited viewing uses only unless otherwise authorized by Macrovision Corporation. Reverse engineering or disassembly is prohibited.

About this owner's manual

This owner's manual explains the basic instructions of this DVD video player. Some DVD video discs are produced in a manner that allows specific or limited operation during playback. As such, the DVD video player may not respond to all operating commands. This is not a defect in the DVD video player. Refer to instruction notes of discs.

“” may appear on the TV screen during operation. A “” means that the operation is not permitted by the DVD video player or the disc at the moment. For example, sometimes it is unable to skip the playback of copyright message of the disc when the SKIP() button is pressed. Alternatively, the “” may also indicate that the feature is not available for the disc.

Notes on region numbers

The region number of this DVD video player is 1. If region numbers, which stand for their playable area, are printed on your DVD video disc and you do not find  or , disc playback will not be allowed by the player. (In this case, the DVD video player will display a message on-screen.)



On VIDEO CDs

This DVD video player supports VIDEO CDs equipped with the PBC (Version 2.0) function. (PBC is the abbreviation of Playback Control.) You can enjoy two playback variations depending on types of discs.

- **VIDEO CD not equipped with PBC function (Version 1.1)**
Sound and movie can be played on this DVD video player in the same way as an audio CD.
- **VIDEO CD equipped with PBC function (Version 2.0)**
In addition to operation of a VIDEO CD not equipped with the PBC function, you can enjoy playback of interactive software with search function by using the menu displayed on the TV screen (Menu Playback). Some of the functions described in this owner's manual may not work with some discs.

Playable discs

This DVD video player can play the following discs.

	Disc Mark	Contents	Disc Size	Maximum playback time
DVD video discs		Audio + video (moving pictures)	12 cm	Approx. 4 hours (single sided disc)
			8 cm	Approx. 80 minutes (single sided disc) Approx. 160 minutes (double sided disc)
VIDEO CDs		Audio + video (moving pictures)	12 cm	Approx. 74 minutes
			8 cm	Approx. 20 minutes
Audio CDs		Audio	12 cm	Approx. 74 minutes
			8 cm (CD single)	Approx. 20 minutes

The following discs are also available.

- CD-R
 - CD-RW
- CD-R/RW discs recorded by CD-DA method can be played. Some CD-R/RW discs may be incompatible.

- You cannot play discs other than those listed above.
- You cannot play discs of DVD-RAM, DVD-RW, etc., or non standardized discs even if they may be labeled as above.
- This DVD video player uses the NTSC color system, and cannot play DVD video discs recorded in any other color system (PAL, SECAM, etc.).
- For MP3 CD, please see page 23.

Table of Contents

Introduction

● SAFETY PRECAUTIONS	2
● IMPORTANT SAFEGUARDS	4
● Precautions	8
● Notes on Discs	9
Notes on region numbers	10
● Table of Contents	11
● Identification of Controls	12
Front panel	12
Rear panel	12
DVD display	13
Remote control	14
Loading batteries	15
Operating with the remote control	15

Connections

● Connecting to a TV	16
Connecting to a TV	16
Connecting to an audio system and TV equipped with component video inputs	17
● Connecting to Optional Equipment	18
Connecting to an amplifier equipped with a Dolby Digital decoder	18
Connecting to an amplifier equipped with Dolby Pro Logic Surround	18
Connecting to an amplifier equipped with a DTS decoder	18
Connecting to an amplifier equipped with an MPEG2 audio decoder	19
Connecting to an amplifier equipped with a digital audio input	19

Playback operation

● Language setup	20
● Playback procedure	21
● Special playback	22

Advanced Function

● MP3 playback	23
● Zooming/Locating desired scene	24
Zooming	24
Locating desired scene	24
● Repeat playback	25
Title, Chapter and Track Playback	25
A-B Repeat Playback	25
● Program playback/Random playback (CD/VCD/MP3)	26
Program playback	26
Random playback	26
● Marking desired scenes/ Karaoke playback	27
● Changing soundtrack language/ Setting the Spatializer/Subtitles	28
Changing soundtrack language	28
Setting the Spatializer	28
Subtitles	28
● Changing angles/Title selection/ DVD menu	29
Changing angles	29
Title selection	29
DVD menu	29
● Setting the aspect ratio of TV screen	30
● Setting on Screen display/ Disc status	31
Setting on Screen display	31
Disc status	31
● Dynamic Range Control	32
● Parental control setting	33
● To change the parental level	34
● Temporary disabling of rating level of DVD disc	35
● Setting menu language	36
● Setting subtitle language	37
● Setting audio soundtrack language	38

Others

● Language code list	39
● Before Calling Service Personnel	40
● Specifications	41
● LIMITED WARRANTY DVD VIDEO PLAYER	42

Identification of Controls

See the page in  for details.

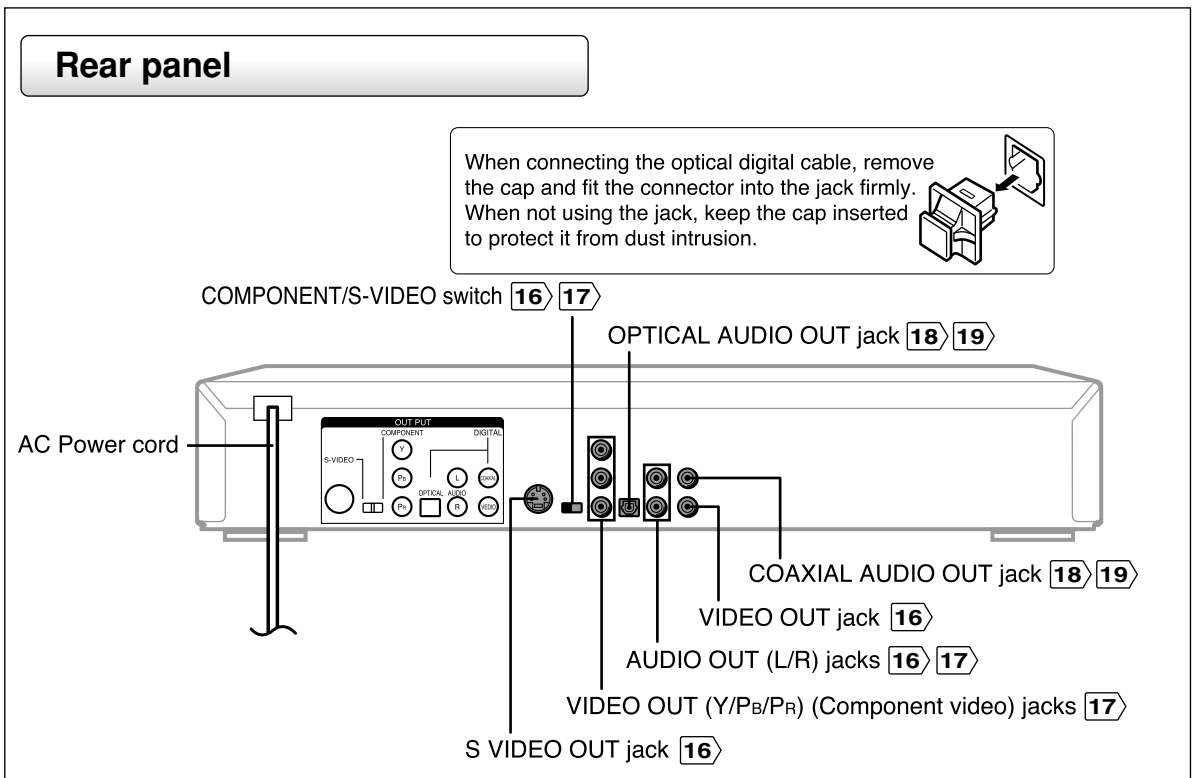
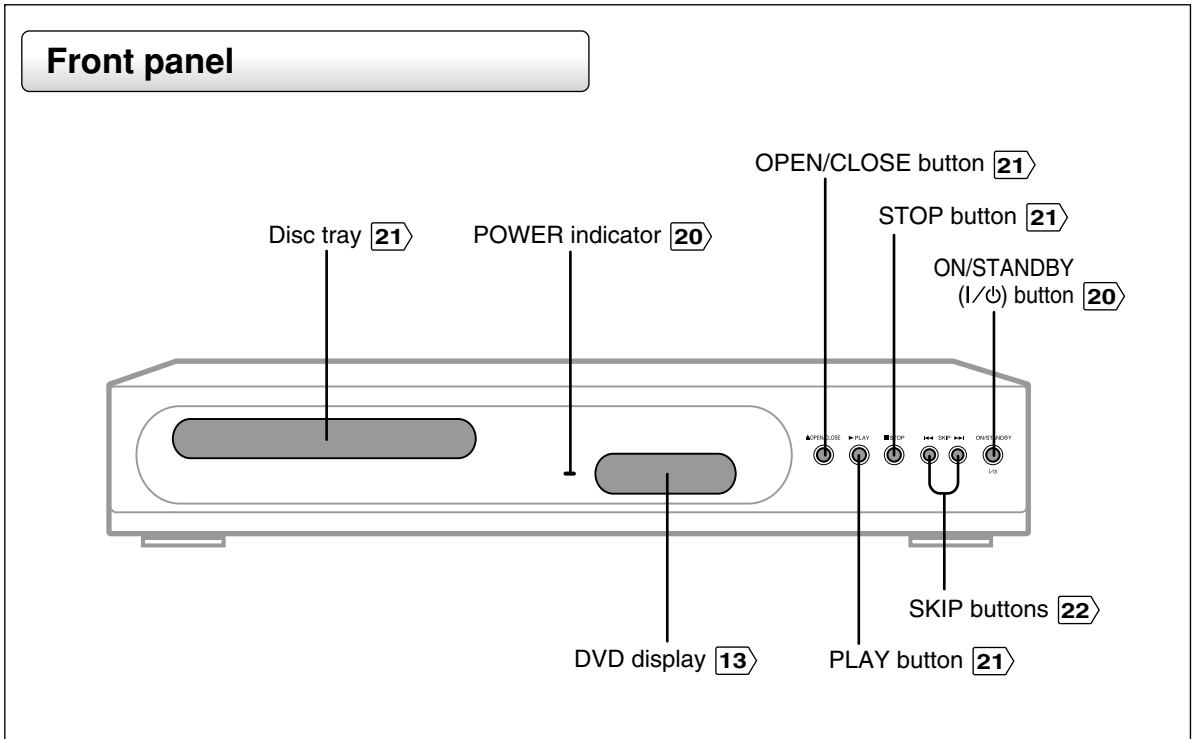

DVD display

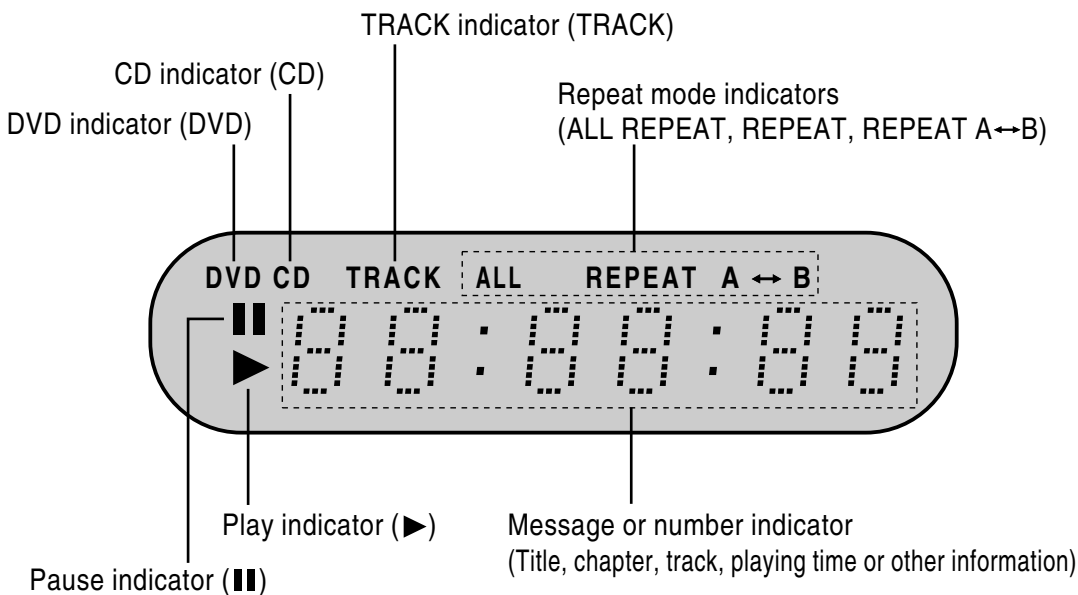

The display may vary depending on the types of discs you play.

DVD video disc

- During playback:

Example

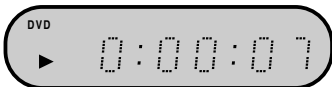

Some discs may not display elapsed time.

VIDEO CD

- During playback:

Example

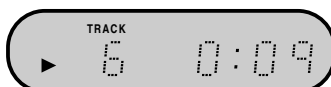

Playing track 6

Some discs may not display track numbers or elapsed time.

Audio CD

- During playback:

Example



Playing track 6

Some discs may not display track numbers or elapsed time.

The instructions in this manual describe the functions on the remote control. See the page in □ for details.

Remote control

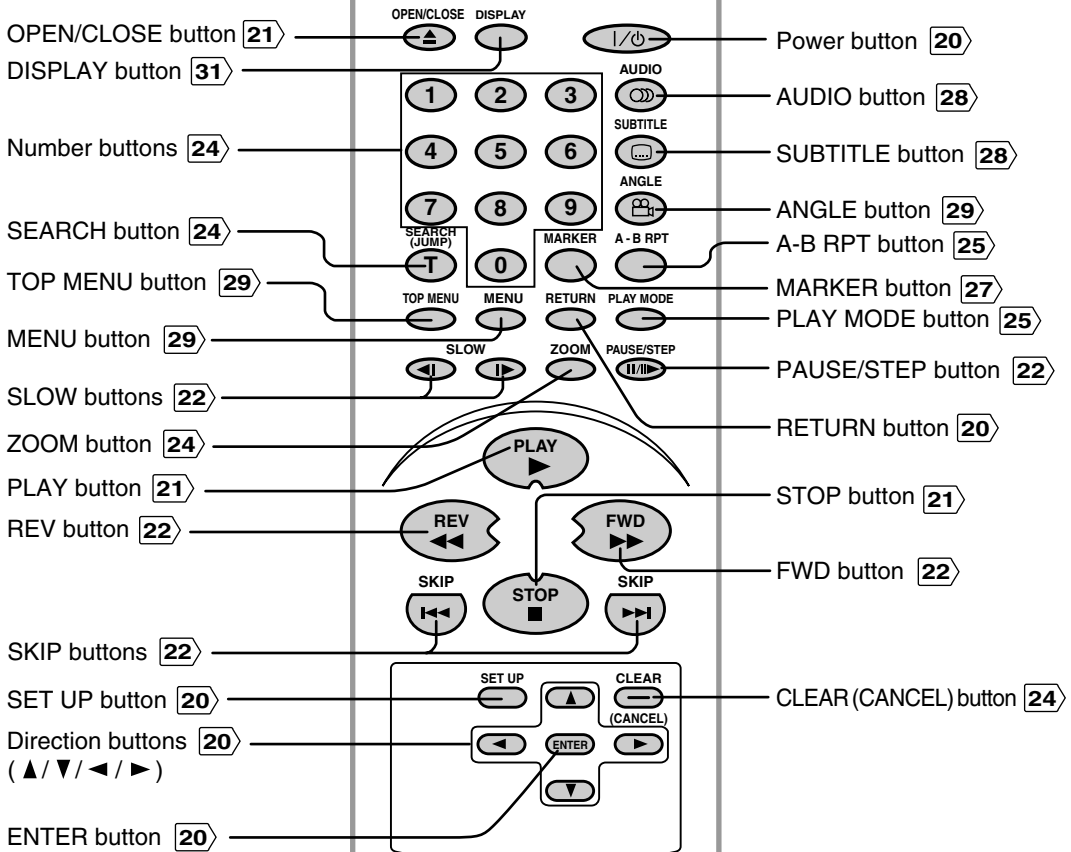

Loading batteries

- 1 Slide the battery compartment cover in the direction of the arrow.

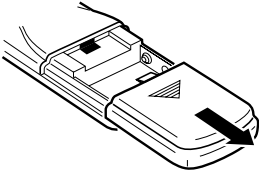

- 2 Install two "AAA" batteries (supplied), paying attention to the polarity diagram in the battery compartment.

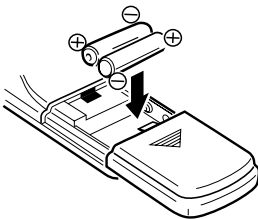

- 3 Replace the compartment cover.

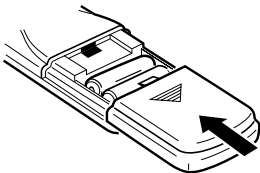

Notes on batteries

Improper use of batteries may cause battery leakage and corrosion. To operate the remote control correctly, follow the instructions below.

- Do not insert batteries into the remote control in the wrong direction.
- Do not charge, heat, open, or short-circuit the batteries. Do not throw batteries into a fire.
- Do not leave dead or exhausted batteries in the remote control.
- Do not use different types of batteries together, or mix old and new batteries.
- If you do not use the remote control for a long period of time, remove the batteries to avoid possible damage from battery corrosion.
- If the remote control does not function correctly or if the operating range becomes reduced, replace all batteries with new ones.
- If battery leakage occurs, wipe the battery liquid from the battery compartment, then insert new batteries.

Operating with the remote control

Point the remote control at the remote sensor and press the buttons.

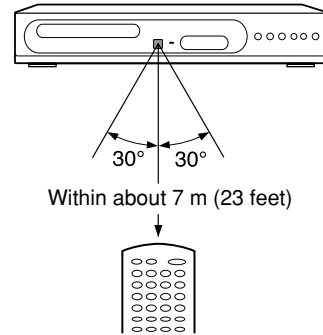

Distance: About 7 m (23 feet) from the front of the remote sensor

Angle: About 30° in each direction of the front of the remote sensor

* Do not expose the remote sensor of the DVD video player to a strong light source such as direct sunlight or other illumination. If you do so, you may not be able to operate the DVD video player via the remote control.

Notes on the remote control

- Direct the remote control at the remote sensor of the DVD video player.
- Do not drop or give the remote control a shock.
- Do not leave the remote control near an extremely hot or humid place.
- Do not spill water or put anything wet on the remote control.
- Do not disassemble the remote control.
- When using the remote control, press the button at intervals of about 1 second to ensure the correct mode of operation.

Connecting to a TV

Connect the DVD video player to your TV.

Connecting to a TV

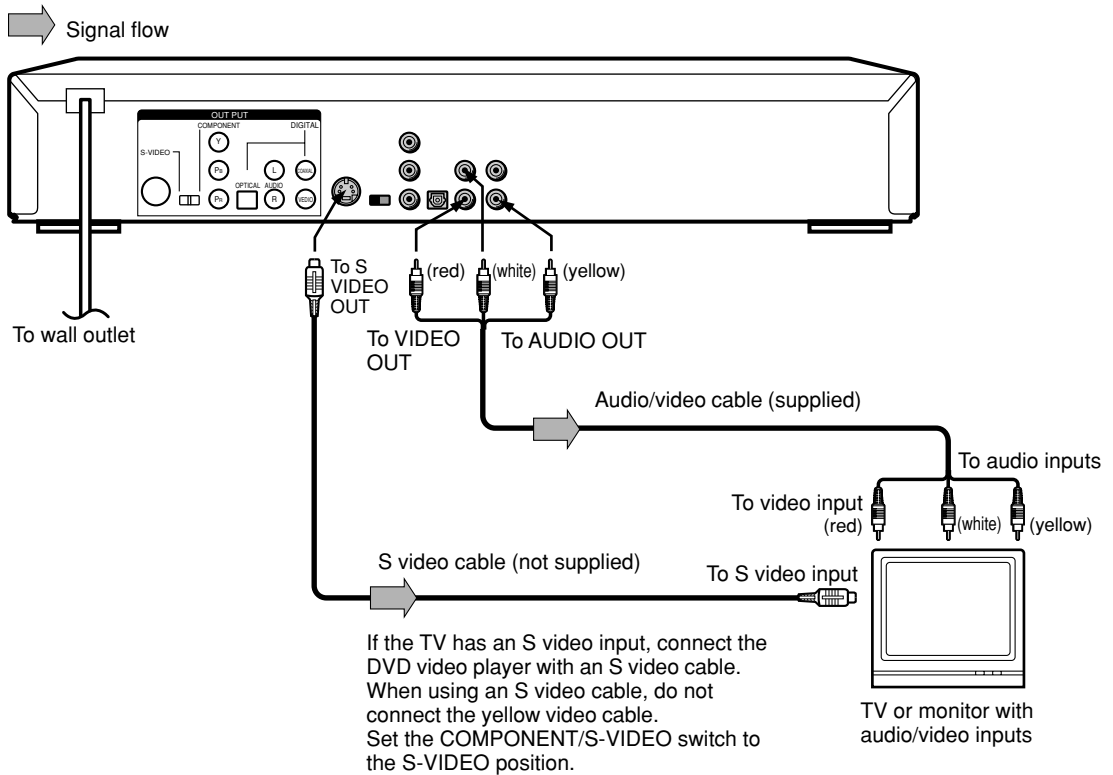

Notes

- Refer to the owner's manual of the connected TV as well.
- When you connect the DVD video player to your TV, be sure to turn off the power and unplug both units from the wall outlet before making any connections.
- If your television set has one audio input, connect the left and right audio outputs of the DVD video player to a Y cable adapter (not supplied) and then connect to your TV.
- Connect the DVD video player directly to your TV. If you connect the DVD video player to a VCR, TV/VCR combination or video selector, the playback picture may be distorted as DVD video discs are copy protected.

Connecting to an audio system and TV equipped with component video inputs

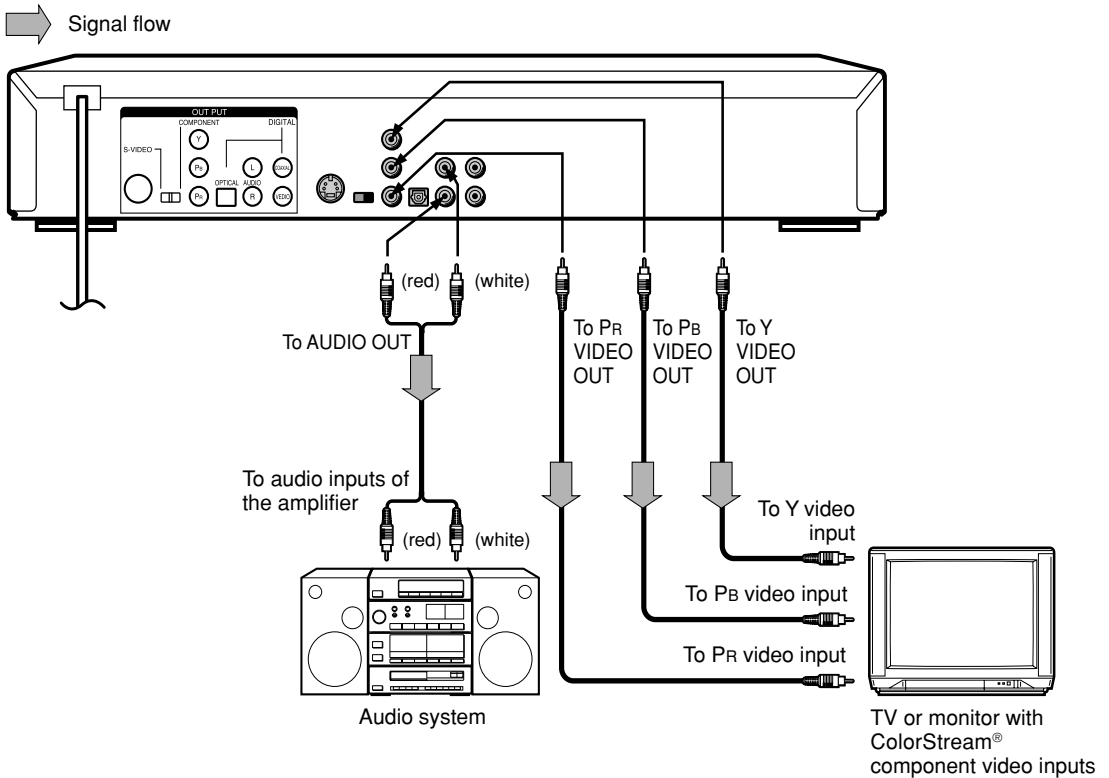

Component video (ColorStream®) outputs/inputs

Some TVs or monitors are equipped with component video inputs. Connecting to these inputs allows you to enjoy the highest quality DVD picture playback.

Set the COMPONENT/S-VIDEO switch to the COMPONENT position.

Actual labels for component video inputs may vary depending on the TV manufacturer. (ex. Y, R-Y, B-Y or Y, C_B, C_R) In some TVs or monitors, the color levels of the playback picture may be reduced slightly or the tint may change. In such a case, adjust the TV or monitor for optimum performance.

Notes

- Refer to the owner's manual of the connected equipment as well.
- When you connect the DVD video player to other equipment, be sure to turn off the power and unplug all of the equipment from the wall outlet before making any connections.
- If you place the DVD video player near a tuner or radio, the radio broadcast sound might be distorted. In this case, place the DVD video player away from the tuner and radio.
- The output sound of the DVD video player has a wide dynamic range. Be sure to adjust the receiver's volume to a moderate listening level. Otherwise, the speakers may be damaged by a sudden high volume sound.
- Turn off the amplifier before you connect or disconnect the DVD video player's power cord. If you leave the amplifier power on, the speakers may be damaged.

Connecting to Optional Equipment

You can enjoy high quality dynamic sounds by connecting the DVD video player to optional audio equipment.

For connection to your TV, see "Connecting to a TV" **16** **17**.

	: Front speaker		: Center speaker
	: Rear speaker		: Signal flow
	: Sub woofer		

Connecting to an amplifier equipped with a Dolby Digital decoder

Dolby Digital

Dolby Digital is the surround sound technology used in theaters showing the latest movies, and is now available to reproduce this realistic effect in the home. You can enjoy motion picture and live concert DVD video discs with this dynamic realistic sound by connecting the DVD video player to a 6 channel amplifier equipped with a Dolby Digital decoder or Dolby Digital processor. If you have a Dolby Pro Logic Surround decoder, you will obtain the full benefit of Pro Logic from the same DVD movies that provide full 5.1-channel Dolby Digital soundtracks, as well as from titles with the Dolby Surround mark.

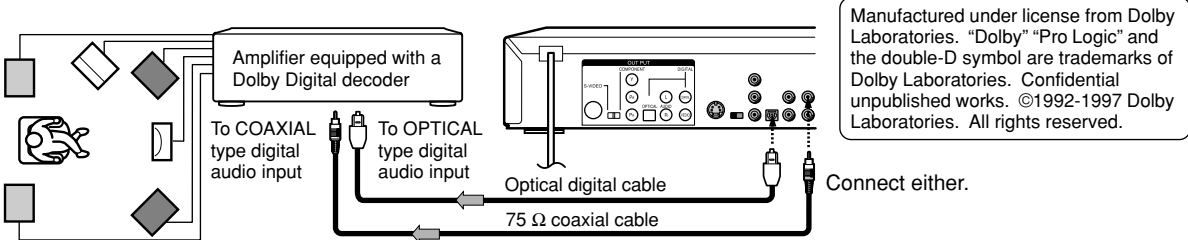

Connecting to an amplifier equipped with Dolby Pro Logic Surround

Dolby Pro Logic Surround

You can enjoy the dynamic realistic sound of Dolby Pro Logic Surround by connecting an amplifier and speaker system (right and left front speakers, a center speaker, and one or two rear speakers).

- With an amplifier equipped with Dolby Digital Connect the equipment the same way as described in "Connecting to an amplifier equipped with a Dolby Digital decoder." Refer to that amplifier's owner's manual and set the amplifier so you can enjoy Dolby Pro Logic Surround sound.
- With an amplifier not equipped with Dolby Digital Connect the equipment as follows.

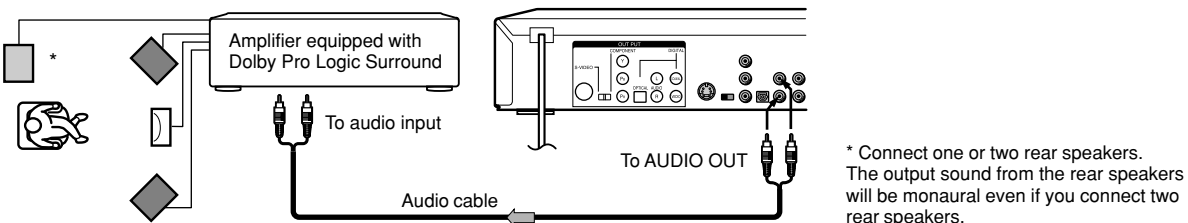

Connecting to an amplifier equipped with a DTS decoder

Digital Theater Systems (DTS)

DTS is a high quality surround technology used in theaters and now available for home use, on DVD video discs or audio CDs. If you have a DTS decoder or processor, you can obtain the full benefit of 5.1 channel DTS encoded sound tracks on DVD video discs or audio CDs.

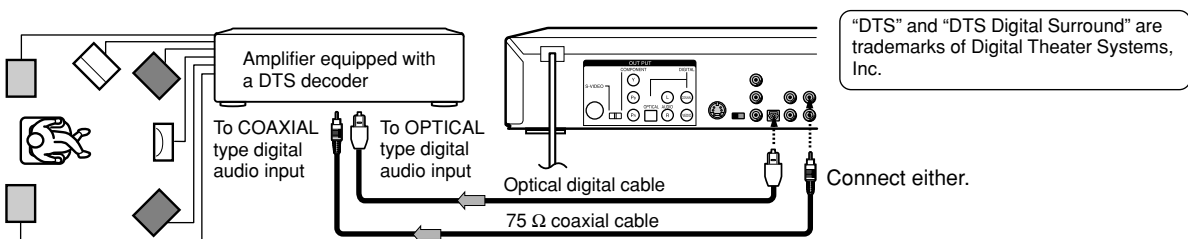

Warning

- When playing DTS-encoded discs (DVD video discs and audio CDs), excessive noise may be output from the analog stereo jacks. To avoid possible damage to the audio system, you should take proper precautions when the AUDIO OUT (L/R) jacks of the DVD video player are connected to an amplification system. To enjoy DTS Digital Surround™ playback, an external 5.1 channel DTS Digital Surround™ decoder system must be connected to the OPTICAL AUDIO OUT jack or COAXIAL AUDIO OUT jack of the DVD video player.

Connecting to an amplifier equipped with an MPEG2 audio decoder

MPEG2 sound

You can enjoy motion picture and live concert DVD video discs with dynamic realistic sound by connecting an amplifier equipped with an MPEG2 audio decoder or MPEG2 audio processor.

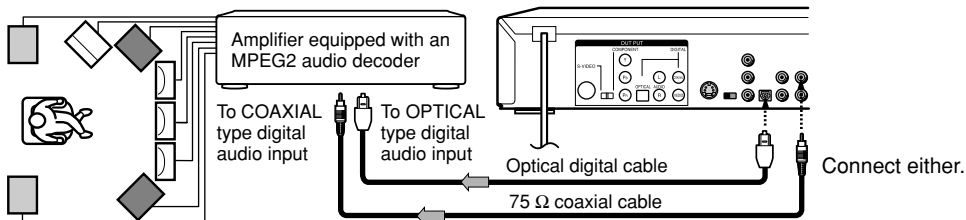

Connecting to an amplifier equipped with a digital audio input

2 channel digital stereo

You can enjoy the dynamic sound of 2 channel digital stereo by connecting an amplifier equipped with a digital audio input and speaker system (right and left front speakers).

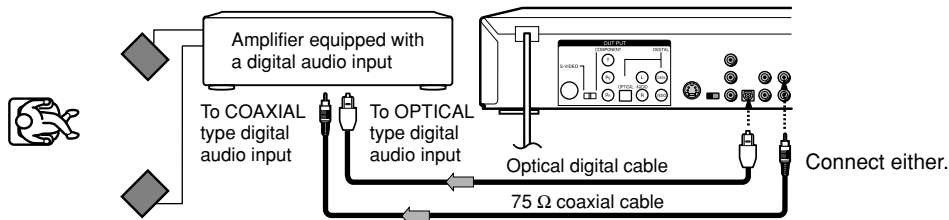

Notes

- DO NOT connect the OPTICAL AUDIO OUT jack or COAXIAL AUDIO OUT jack of the DVD video player to the AC-3 RF input of a Dolby Digital Receiver. This input on your A/V Receiver is reserved for Laserdisc use only and is incompatible with the OPTICAL AUDIO OUT jack or COAXIAL AUDIO OUT jack of the DVD video player.
- Connect the OPTICAL AUDIO OUT jack or COAXIAL AUDIO OUT jack of the DVD video player to the "OPTICAL" or "COAXIAL" input of a Receiver or Processor.
- Refer to the owner's manual of the connected equipment as well.
- When you connect the DVD video player to other equipment, be sure to turn off the power and unplug all of the equipment from the wall outlet before making any connections.
- The output sound of the DVD video player has a wide dynamic range. Be sure to adjust the receiver's volume to a moderate listening level. Otherwise, the speakers may be damaged by a sudden high volume sound.
- Turn off the amplifier before you connect or disconnect the DVD video player's power cord. If you leave the amplifier power on, the speakers may be damaged.

Language setup

The setup language can be selected.

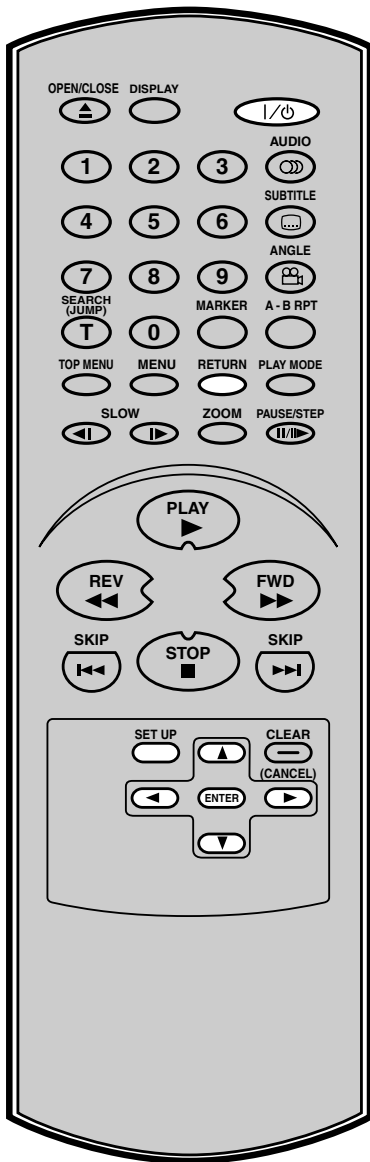

Preparation

- Turn ON the TV and select to the corresponding video input.
- When using an amplifier, switch on the amplifier.

1 Press **I/O** (**POWER**) on the unit or on the remote control to turn on the unit. The **POWER** indicator will light up.

“Reading” display will change to “No Disc”. (If DVD disc has already loaded, playback will start automatically.)



2 From the stop mode press **SET UP**. Press **◀** or **▶** to select “Other”.

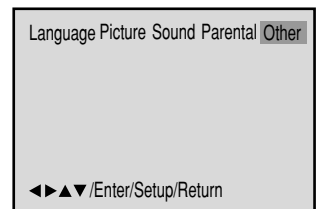

3 Press **▼** or **ENTER** to select “OSD Language”.

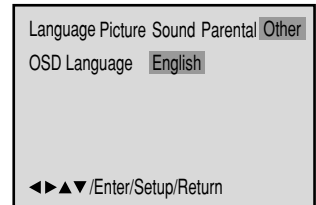

4 Press **▶** or **ENTER** and then press **▲** or **▼** to select desired language (e.g. English), then press **ENTER**.

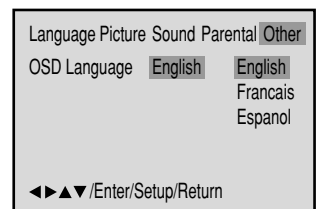

NOTE: To exit the **SETUP** screen, press **SET UP** (or **RETURN**) while the **SETUP** screen is displayed.

• **If the unit does not operate properly:** Static electricity, etc., may affect the player's operation. Disconnect the AC power cord once, then connect it again.

Playback procedure

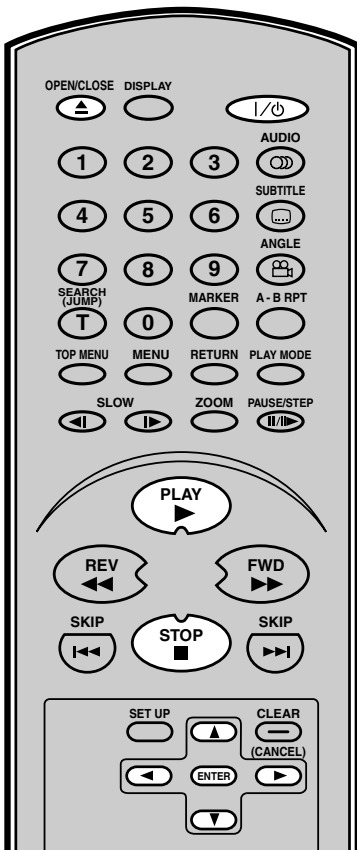

1 Press **OPEN/CLOSE** on the unit or on the remote control. The disc tray will open.

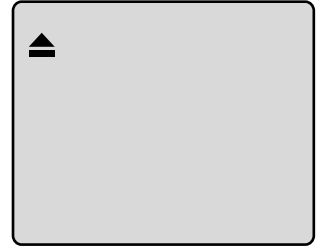

2 Place a disc onto the tray. Hold the disc, position it with the printed label side up, align it with the guides, and place it in its proper position.

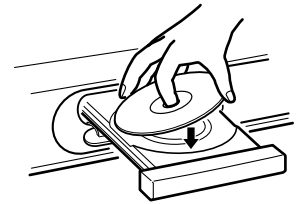

3 Press **PLAY** or **OPEN/CLOSE** on the unit or on the remote control. The disc tray closes automatically. The TV-screen display, ▲ changes to "Reading" and then playback commences.

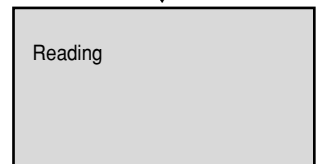

- A menu screen will appear on the TV screen, if the disc has a menu feature.

4 Press ▲/▼ or ◀/▶ to select desired title.

5 Press **ENTER** or **PLAY**.
• Title is selected and play commences.

6 Press **STOP** to end playback.
• The unit memorizes the stop location, depending on the disc. "■" appears on the screen. Press **PLAY** to resume playback (from the stopped location).
• If you press **STOP** again or unload the disc ("■" appears on the screen.), the unit will clear the stopped location from its memory.

7 To stop playback, press **STOP**. Then press **OPEN/CLOSE** on the unit or on the remote control. The disc tray opens. Remove the disc and press **OPEN/CLOSE** on the unit or on the remote control then press I/⏻ (**POWER**). The disc tray closes automatically and unit turns off.

Note:

- If a non-compatible disc is loaded, "Incorrect Disc", "Region Code Error" or "Parental Error" will appear on the TV screen according to the type of loaded disc. In this case, check your disc again (See pages 10 and 33).
- Some discs may take a minute or so to start playback.
- When you insert a disc with the label facing downwards (ie. the wrong way up) and press **PLAY** or **CLOSE** on the unit, "Reading" will appear on the display and then "Incorrect Disc" will be displayed.
- Some playback functions of DVDs may be intentionally fixed by software producers. This unit plays DVDs in accordance with the design intent of the software producers. Some playback features may not be available. Also refer to the instructions supplied with the DVD.
- When playing DTS-encoded Audio CDs, excessive noise will be heard from the analogue stereo outputs. To avoid possible damage to the audio system, take proper precautions when the analogue stereo outputs of the DVD player are connected to an amplification system.

Special playback

Note: there may be a slight delay between you pressing the button and the function activating.

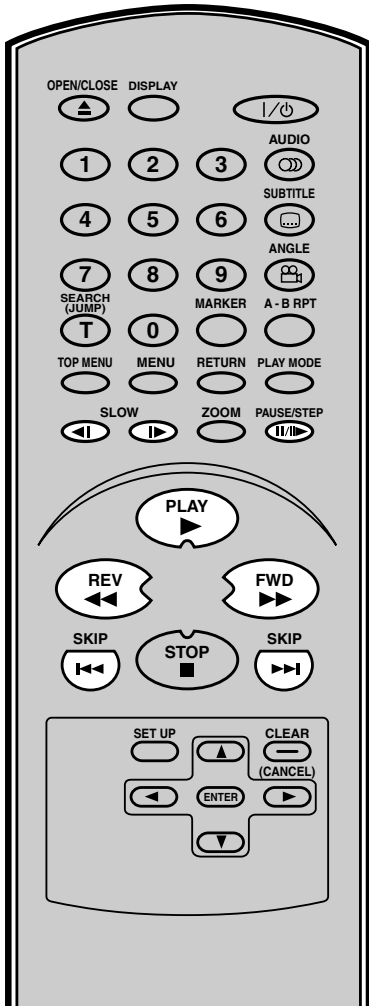

Note: The unit is capable of displaying a still video image or On Screen Display image on your television indefinitely. If you leave a still video image or On screen display image displayed on your TV for an extended period of time, you risk permanent damage to your television screen. Projection televisions are particularly susceptible. If you must display a still image for a prolonged time, reduce the contrast and brightness of your set. This, however, will not insure damage will not occur to your screen always exercise caution when displaying still images.

Fast Forward Playback

Press **FWD** during normal playback. Each press of the **FWD** button will increase the speed of the search ►►, ►►►, ►►►►, ►►►►►.

- To resume normal playback, press **PLAY**.

Review Playback

Press **REV** during normal playback. Each press of the **REV** button will increase the speed of the search ◀◀, ◀◀◀, ◀◀◀◀, ◀◀◀◀◀.

- To resume normal playback, press **PLAY**.

Still Playback

Press **PAUSE/STEP** during normal playback to pause playback.

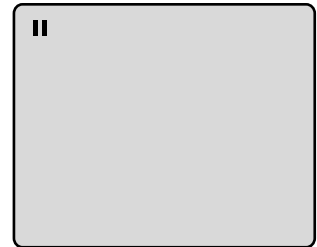

To resume normal playback, press **PLAY**.

Frame Advance

Press **PAUSE/STEP** during still playback. One frame is advanced each time you press **PAUSE/STEP**.

To resume normal playback, press **PLAY**.

Slow-motion Playback

Press **SLOW**(◀|) Reverse or **SLOW**(|▶) Forward during normal playback or still playback. Each press of **SLOW** will change the speed of the slow x1/2, x1/4, x1/6, x1/7.

Note:

The VIDEO CD can not play Reverse Slow.

- To resume normal playback, press **PLAY**.
- To resume the still playback, press **PAUSE/STEP**.

Locating a chapter or track

Press **SKIP**(▶▶) Forward or **SKIP**(◀◀) Reverse during playback to locate a chapter that you want to watch. Each time you press the button, a chapter or track is skipped.

MP3 Playback

This player can play back the MP3-data which has been recorded on CD-R or CD-RW. To produce the MP3-data, you need a Windows-PC with CD-ROM drive and a MP3-encoding Software (not supplied). The Apple-HFS-System can not be played.

MP3 CD Information

Limitations on MP3 CD playback

- MP3 CD is the disc that is standardized by ISO9660, its file name must include 3-digits extension letters, "mp3".
- The directory and file names of the MP3 CD must correspond to the ISO standardized files.
- This unit can read 200 files per disc. If one directory has more than 200 files, it reads up to 200 files, the remaining files will be omitted.
- As for multi-session disc, only the first session can be played.
- If the CD has both audio tracks and MP3 files, only audio tracks are played.
- It may take more than one minute for this unit to read MP3 files depending on its structure.
- Music recorded by "Joliet Recording Specification" can be played back, the file name is displayed (within 17 letters) on the screen. Long file names will be condensed.
- The music files recorded by "Hierarchical File System" (HFS) cannot be played.

Limitations on display

- The maximum number for display is 17 letters. Available letters for display are the following: capital or small alphabets of A through Z, numbers of 0 through 9, and _ (under score).
- Other characters than those above are replaced in hyphen.

Notes on MP3 files

To play back a MP3 CD in the recorded order,

1. Use MP3 software that records data alphabetically or numerically.
2. Name each file including two-digit or three-digit number (e.g. "01" "02" or "001" "002").
3. Refrain from making too many sub-folders.

CAUTION:

- Some MP3 CDs cannot be played back depending on the recording conditions.
- A CD-R/RW that has no music data or non-MP3 files cannot be played back.

Preparation:

- Turn ON the TV and select the corresponding video input.

- 1 Press **OPEN/CLOSE**.
The disc tray will open.
Place a disc onto the tray.

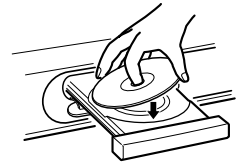

- 2 Press **PLAY** or **OPEN/CLOSE**.
The disc tray closes automatically.
"Reading" will appear on screen.
Reading time will change depending on the quantity of files on the disc.

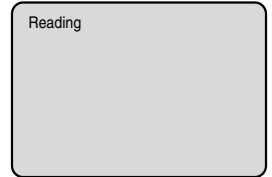

- 3 A MP3 menu screen will appear on the TV screen.
Press **◀/▶** or **ENTER** to select desired folder.

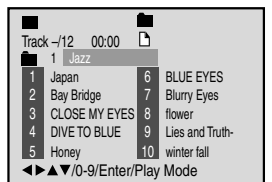

- 4 Press **▲/▼** or **◀/▶** or **Number keys** to select the desired track, then press **ENTER**. Track is selected and play commences.
• In the event the folder includes more than 11 tracks, press **◀** or **▶** to display next track list.

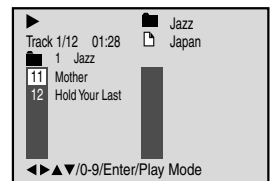
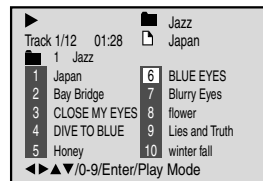

- 5 Press **STOP** to end playback.
• The unit memorizes the stopped point. "■" appears on the screen. Press **PLAY** to resume playback (from the memorized location point).
• If you press **STOP** again or unload the disc, the unit will clear the memorized location from its memory.

- 6 Then press **OPEN/CLOSE**.
The disc tray opens.
Remove the disc and press **POWER**.
The disc tray closes automatically and DVD turns off.

NOTES:

- During MP3-Playback, you cannot use SEARCH, or A-B Repeat functions.
- You can use Repeat (Track and All), Random and Program functions for MP3 CD Playback. (See page 25 and 26)
- MP3-Playback may take two minutes or so to start the reading for the first time.

Zooming/Locating desired scene

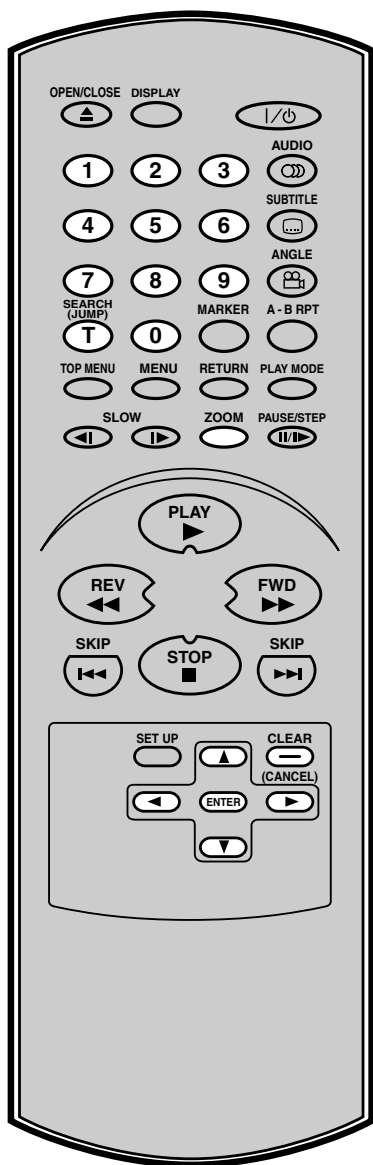

Zooming

This unit will allow you to zoom in on an image. You can then make selections by switching the position of the zoom point on the frame.

1 Press **ZOOM** during playback.

The center part of the image will be zoomed.

Each press of **ZOOM** will change the ZOOM power.

Q 1 (x 1.3), Q 2 (x 1.5) and Q 3 (x 2.0).

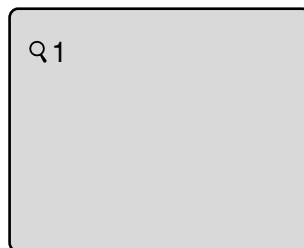

2 Press **▲ / ▼ / ◀ / ▶** to view a different part of the frame. You may move the frame from the center position to UP, DOWN, LEFT or RIGHT direction.

3 In the zoom mode press **ZOOM** repeatedly to return to a 1:1 view (Q Off).

Locating Desired Scene

Use the title, chapter and time recorded on the disc to locate the desired to play back point.

1 Press **SEARCH (JUMP)** during playback.

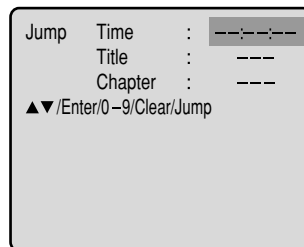

2 Press **▲** or **▼** to select the "Time", "Title" or "Chapter".

3 Press **Number buttons (0-9)** to change the number.

- If you input a wrong number, press **CLEAR (CANCEL)**.
- Refer to the package supplied with the disc to check the numbers.

4 Press **ENTER**.

- Playback starts.
- When you change the title, playback starts from Chapter 1 of the selected title.
- Some discs may not be compatible with the above operation.

Note:

- You can select Pause, Slow or Search playback from the zoom mode.
- Some discs may not respond to the zoom feature.

Repeat playback

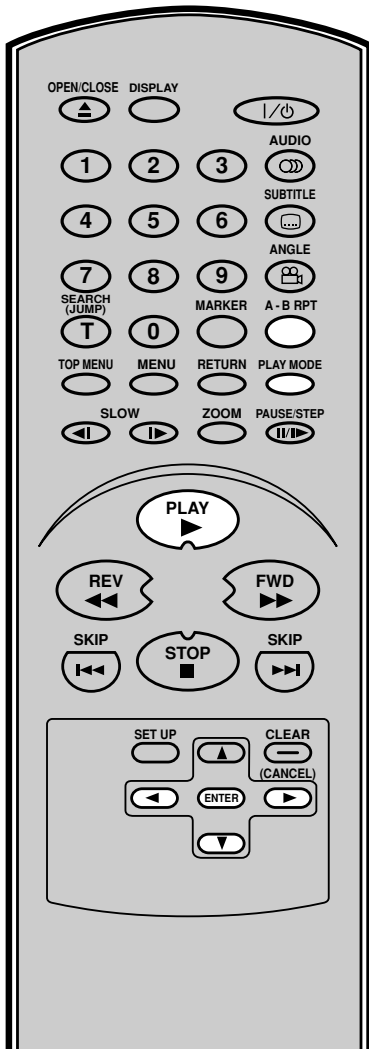

Note:

- Some discs may not be compatible with the repeat operation.
- In A-B Repeat mode, subtitles near the A or B locations may not be displayed.
- You can not set the A-B Repeat for the scenes that include multiple angles.
- You may not be able to set A-B Repeat, during certain on the scenes of the DVD.
- A-B Repeat does not work with an interactive DVD.

Title, Chapter and Track Playback

Press **PLAY MODE** during playback or stop mode.

DVD

Press ◀/▶ or **ENTER** once or twice to select “Chapter” or “Title”.

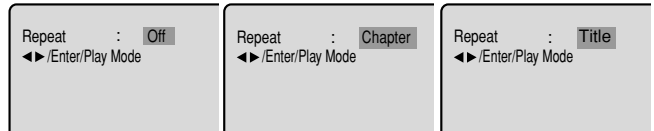

Audio/MP3 CD

Press ▼ to select “Repeat”.

Press ◀/▶ or **ENTER** once or twice to select “Track” or “All”.

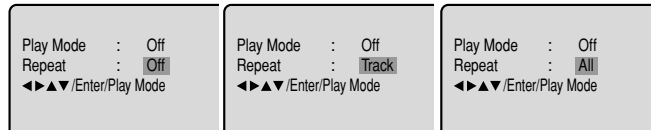

Press **PLAY MODE** again to exit the On Screen Display.

Press **PLAY** to start Repeat playback.

To resume normal playback, select Repeat “Off”.

A-B Repeat Playback

A-B repeat playback allows you to repeat material between two selected points.

- 1 Press **A-B RPT** during playback.
The start point is selected.



- 2 Press **A-B RPT** again.
The end point is selected. Playback starts at the point that you selected. Playback stops at the end point, and resumes again at point A.

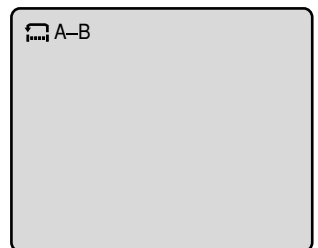

To resume normal playback press **A-B RPT** again.

“Off” appears on the screen.

Program playback/Random playback (CD/ VCD/MP3)

You can arrange the playback order of tracks on the disc.

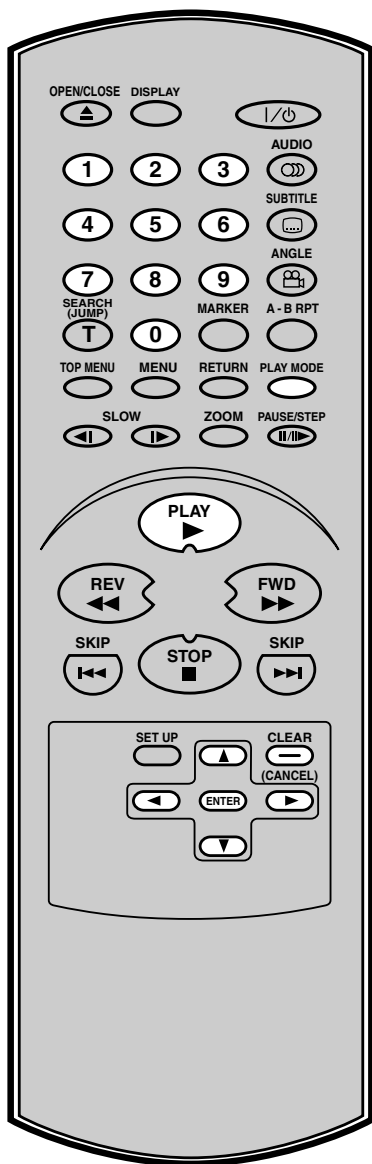

Program playback

1 Press **PLAY MODE** in the stop mode.

2 Press **▲/▼** to select Play Mode, then press **◀/▶** to select "Program".

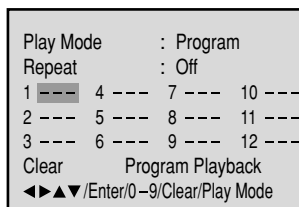

3 Press **▲/▼** or **◀/▶** to select the programming position. Use **Numbered buttons (0-9)** to input the Track numbers.

- To program others, repeat Step 3.
- If you input a wrong number, press **CLEAR (CANCEL)**.

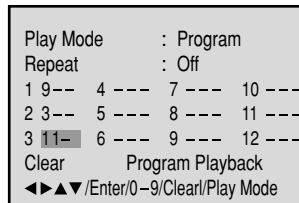

4 Press **▲/▼** or **◀/▶** to select "Program Playback" and press **ENTER**.

The programs in the order you selected will start playback.

To return to normal playback, select Play Mode: "Off".

- To cancel program play, select "Clear" and press **ENTER** in step 3.
- The program is cancelled when you open the disc tray or turn the power off.

CD/VCD

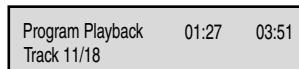

MP3 CD

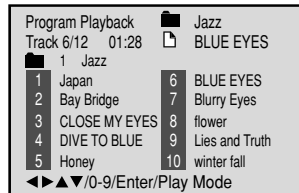

Random playback

1 Press **PLAY MODE** in the stop mode.

2 Press **▲/▼** to select Play Mode, then press **◀/▶** to select "Random".

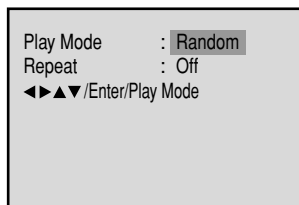

3 Press **PLAY**.

- To cancel Random playback, press **STOP** twice.

Marking desired scenes/Karaoke playback

The unit stores the points that you want to watch again up to 3 points. You can resume playback from each scene.

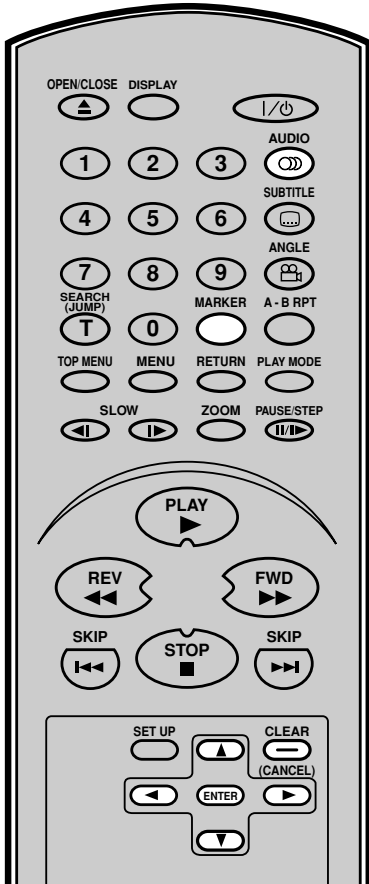

NOTES:

- Some discs may not work with the marking operation.
- The marking is canceled when you open the disc tray or turn the power off.
- Some subtitles recorded around the marker may fail to appear.
- The vocal output feature is used during playback of Dolby Digital (multi-channel) recorded DVD KARAOKE discs. This feature allows you to turn off vocal audio tracks, or restore them for background accompaniment.
- When playing KARAOKE, connect appropriate audio equipment such as an amplifier to the DVD.

Marking the scenes

- 1 Press **MARKER** during playback.
 - 2 Select the blank Marker using **▲/▼**.
Then press **ENTER** at the desired scene.
- Repeat this procedure to set the other 2 scenes.

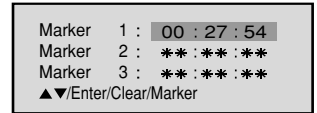
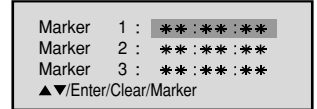

- 3 Press **MARKER** to remove this display.

Returning to the scenes

- 1 Press **MARKER** during playback or stop mode.
- 2 Press **▲/▼** to select the Marker 1-3.
- 3 Press **ENTER**.
Playback starts from the marked scene.

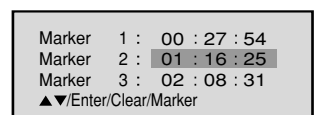
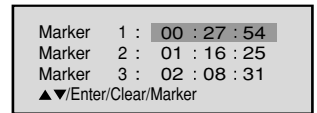

To cancel the mark

- 1 Press **MARKER**.
- 2 Press **▲/▼** to select the Marker 1-3.
- 3 Press **CLEAR**.
To remove this display, press **MARKER**.

Karaoke playback

You can turn the vocal on or off recorded on the DVD KARAOKE.

- 1 During DVD KARAOKE disc playback, press **AUDIO**.
- 2 Press **▲** or **▼** until the KARAOKE symbol (🎤) appears.
- 3 Press **◀/▶** to select "On" or "Off".

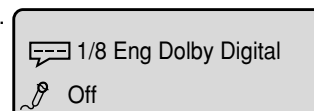
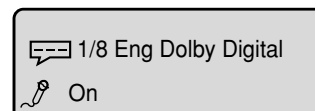
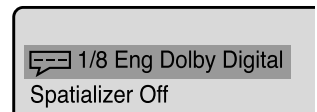

- On : The primary vocal is output when it is recorded on the disc.
- Off : The primary vocal is not output.

Changing soundtrack language/Setting the Spatializer/Subtitles

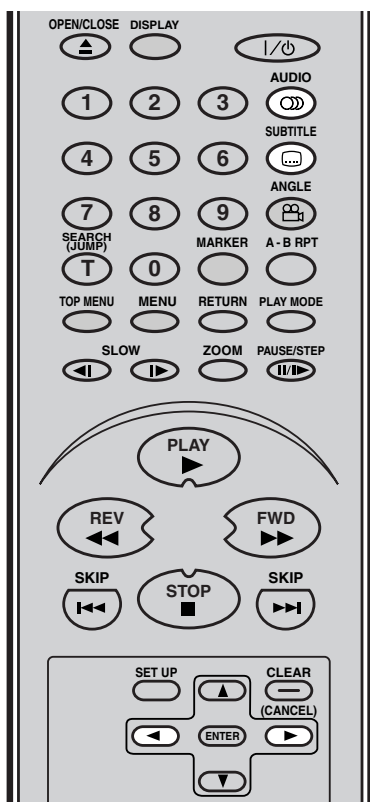

Changing soundtrack language

You can select a desired language from a multilingual disc.

1 Press **AUDIO** during playback.

The current soundtrack language will appear.

1/8 Eng DolbyDigital
Spatializer Off

2 Press **AUDIO** repeatedly until the desired language is selected.

2/8 Fra DolbyDigital
Spatializer Off

■ In case of VIDEO CD playback

Audio type changes as follows each time you press **AUDIO**.

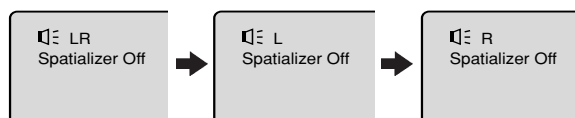

Setting the Spatializer

You can enjoy virtual surround sound effects from your stereo TV, on stereo system.

1 Press **AUDIO** during playback. "Spatializer Off" will appear.

2/8 Fra DolbyDigital
Spatializer Off

2 Press ◀ or ▶ to select the "Spatializer On".

2/8 Fra DolbyDigital
Spatializer On

Subtitles

Turning the Subtitles On and Off

When playing back a disc recorded with subtitles, you can turn the subtitles on or off.

Press **SUBTITLE** during playback until "Off" appears.

Off

Changing the subtitle language

You can select the language when playing back a disc recorded with multilingual subtitles.

1 Press **SUBTITLE** repeatedly during playback until your desired language appears.

1/32 Eng

2 The on-screen display will disappear after a few seconds.

Note:

- If the desired language is not heard after pressing the button several times, the soundtrack language is not recorded on the disc.
- A selected soundtrack language may be cancelled when you open the disc tray or turn the power off. The initial default language or available language will be heard if the disc is played back again.
- Depending on the DVD, you may not be able to change subtitles, on turn subtitles on or off.
- While playing a DVD, the subtitle may change when: -you open or close the disc tray.
- In some cases, a selected subtitle language may not be changed immediately.
- During MP3 playback, the "SPATIALIZER VIRTUAL SURROUND" feature is not effective.

Spatializer® 3-Dimensional Sound Processing provided by Desper Products, Inc.
Certain audio features of this product manufactured under a license from Desper Products, Inc., Spatializer® and the circle-in-square device are trademarks owned by Desper Products, Inc.

Changing angles/Title selection/DVD menu

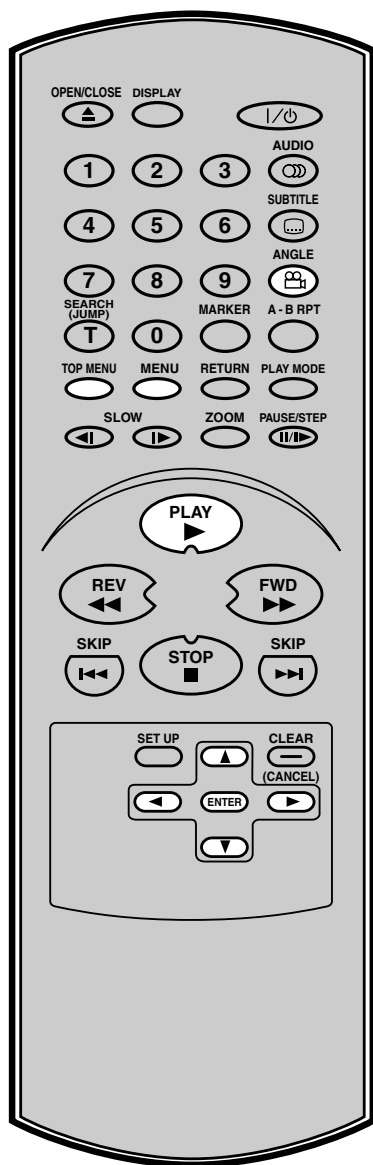

Note:

- Depending on the DVD, you may not be able to change the angles even if multi-angles are recorded on the DVD.
- Depending on the DVD, you may not be able to select the title. On some DVD's a "title menu" may simply be called a "menu" or "top menu" in the instructions supplied with the disc.

Changing Angles

When playing back a disc recorded with multiple camera angles, you can change the angle that you are viewing.

- 1 Press **ANGLE** during playback.

The current angle will appear.



- 2 Press **ANGLE** repeatedly until the desired angle is selected.

Title Selection

Two or more titles may be recorded on some discs. If a title menu is recorded on the disc, you can select the desired title.

- 1 Press **TOP MENU** during playback. Title menu appears on the screen.
- 2 Press **▲/▼** or **◀/▶** to select the desired title.
- 3 Press **ENTER** or **PLAY**. The playback of the selected title will start.

DVD Menu

Some DVDs allow you to select the disc contents via the disc menu.

When you play back these DVDs, you can select the subtitle language and sound-track language, etc. from the **MENU**.

- 1 Press **MENU** during playback. The DVD menu appears on the screen.
 - Press **MENU** again to resume playback at the scene when you pressed **MENU**.
- 2 Press **▲/▼** or **◀/▶** to select the desired item.
- 3 Press **ENTER**. The menu continues to another screen. Repeat steps 2 and 3 to set the item completely.

Setting the aspect ratio of TV screen

You can select an aspect ratio appropriate to your TV.

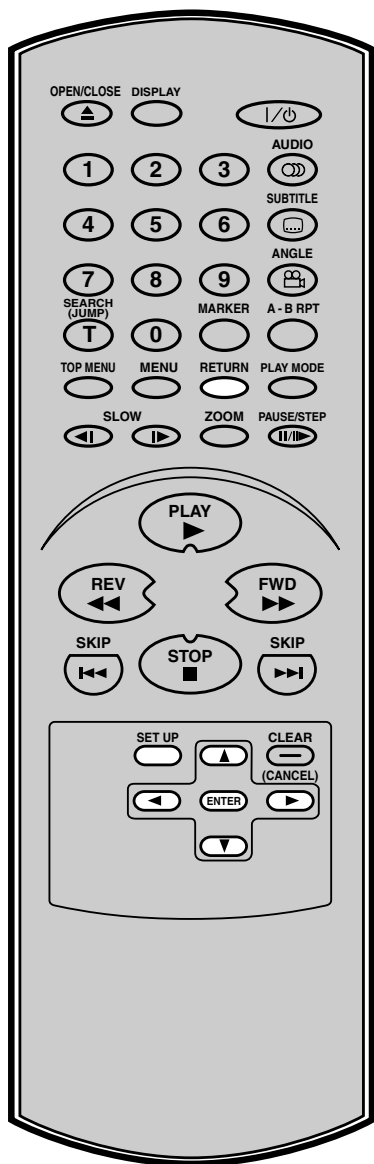

- 1 Press **SET UP** from the stop mode. Press **◀** or **▶** to select "Picture".

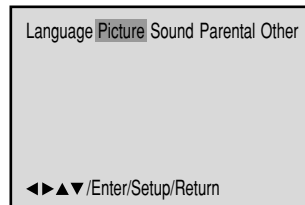

- 2 Press **▼** or **ENTER**, then press **▲** or **▼** to select "Tv Screen".

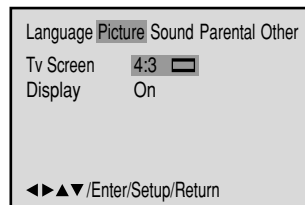

- 3 Press **▶** or **ENTER**. Press **▲** or **▼** to select your desired screen type, then press **ENTER**.

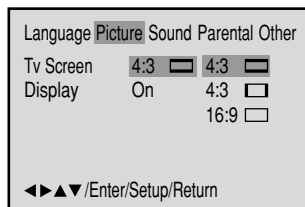

You have the following screen sizes to choose from:

4:3 Normal TV

Select this mode when connecting to a conventional TV. When playing back a wide screen-DVD disc, it displays the wide picture with black bands at the top and bottom of screen.

4:3 PAN SCAN (Conventional mode)

Displays the wide picture on the whole screen with left and right edges automatically cut off.

16:9 WIDE SCREEN

Select this mode when connecting to a wide-screen TV. A wide screen picture is displayed full size.

- 4 To exit the SETUP menu, press **SET UP** or **RETURN**.

Note:

If the DVD disc is not formatted in the pan & scan style, it will display a letterboxed picture.

Setting on Screen display/Disc status

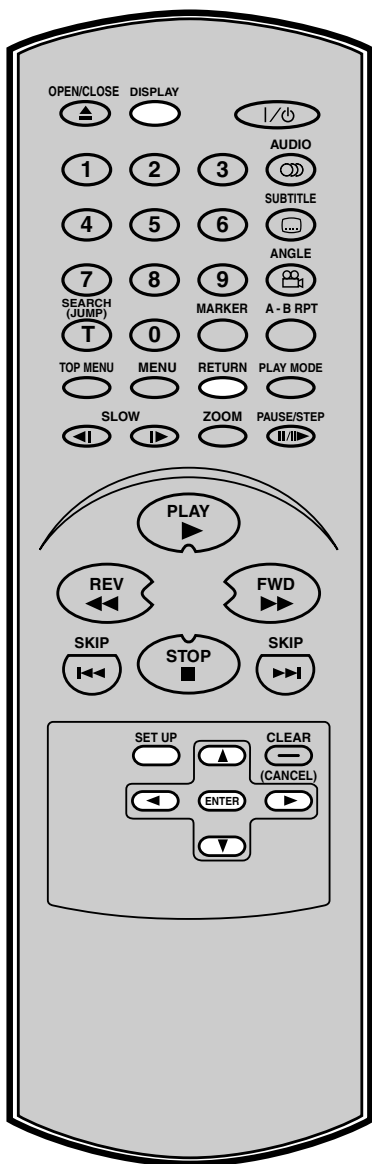

Setting on Screen display

On screen display can be viewed when you press the operation buttons.

1 Press **SET UP** from the stop mode. Press **◀** or **▶** to select "Picture".

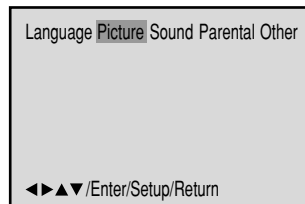

2 Press **▼** or **ENTER**, then press **▲** or **▼** to select "Display".

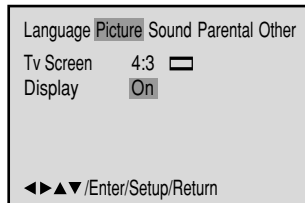

3 Press **◀/▶** or **ENTER** to select "On" or "Off".

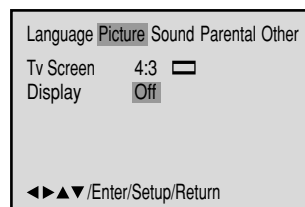

On: On screen displays appear when you press the operation buttons (factory setting).

Off: On screen displays do not appear when operation buttons are pressed.

4 To exit the SETUP screen, press **SET UP** or **RETURN** while the SETUP screen is displayed.

Disc status

With each Press of **DISPLAY**, the status of the disc will appear on the screen and change as follows.

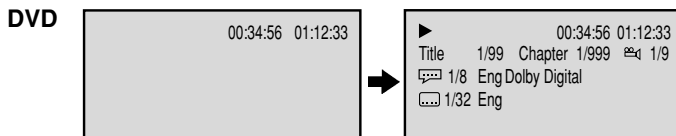

To make status display disappear, press **DISPLAY** again.

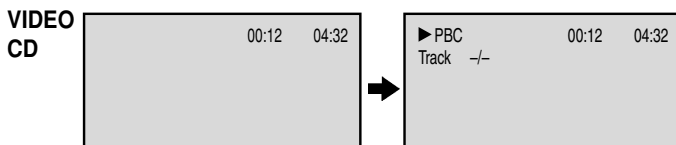

When you playback the CD disc, the status display will appear on the screen and continue displaying.

Dynamic Range Control

DRC (Dynamic Range Control) reduces the range between the quietest and loudest scenes on the disc.

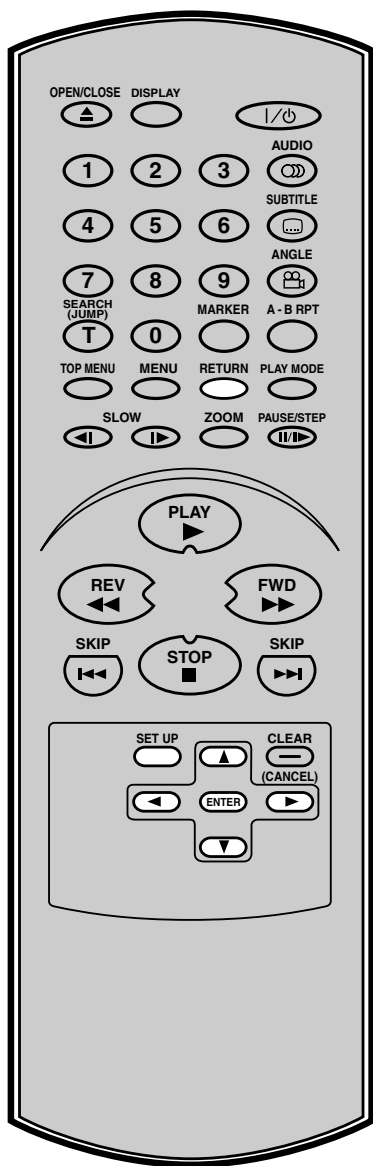

1 Press **SET UP** from the stop mode.
Press ◀ or ▶ to select "Sound".

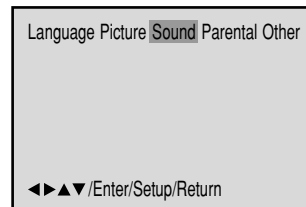

2 Press ▼ or **ENTER** to select "DRC".

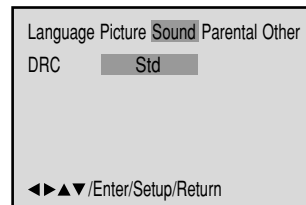

3 Press ▶ or **ENTER**, then press ▲ or ▼ to select desired setting.

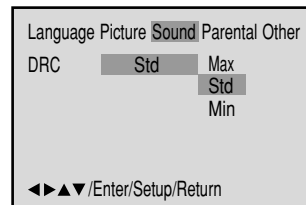

Max: Level difference is big.

Std: Level difference is medium.

Min: Level difference is small.

4 To exit the **SETUP** screen, press **SET UP** or **RETURN** while the **SETUP** screen is displayed.

Note:

- This function works only during playback of Dolby Digital recorded discs.
- The level of Dynamic Range Reduction may differ depending on DVD video disc.

Parental control setting

Some discs are specified as not suitable for children. Playback of such discs can be restricted with this unit.

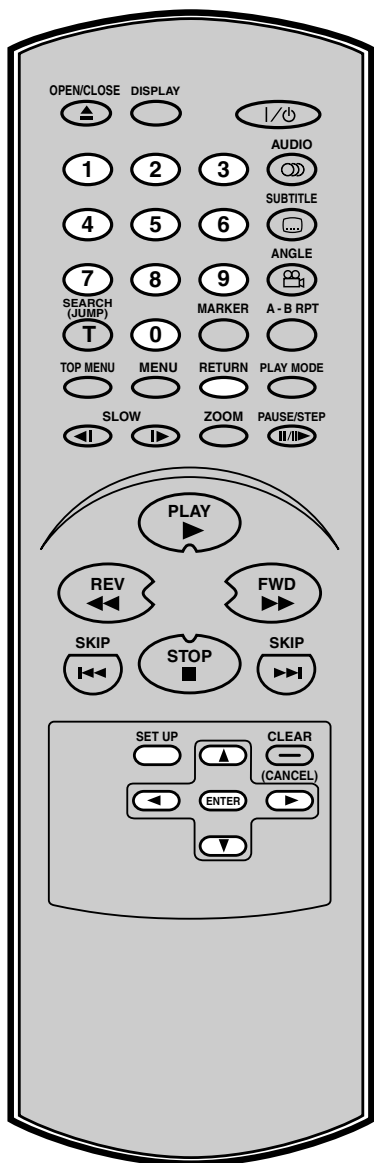

Note:

• When each setup function (P.30~38) has been completed, the unit can always be operated under the same conditions (especially with DVD discs).

Each setup command will be retained in the memory even if you turn the power off.

- Depending on the discs, the unit may not be able to limit playback.
- Some discs may not be encoded with specific rating level information though its disc jacket says "adult." For those discs, the parental control feature will not work.

1 Press **SET UP** from the stop mode. Press ◀ or ▶ to select "Parental". Then press ▼ or **ENTER**.

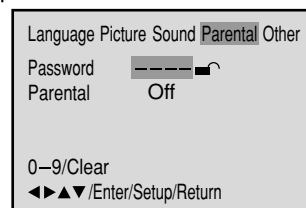

2 Press ▲ or ▼ to select "Parental", then press ◀ or ▶ until the level you require appears.

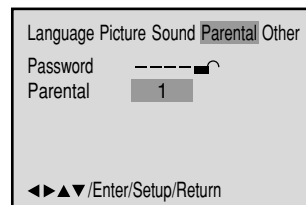

- **Level Off** : The parental control setting does not function.
- **Level 8** : Virtually all DVD software can be played back.
- **Level 1** : DVD software for adults cannot be played back.
- Select from level 1 to level 8. The limitation will be more severe as the level number decreases.

3 Press ▲ or ▼ to select "Password". Press **number buttons (0-9)** to input a 4-digit password. Be sure to remember this number!
• If you input a wrong number, press **CLEAR (CANCEL)**.

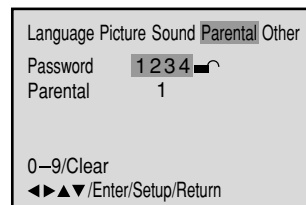

4 Press **ENTER** to store the password.

Note: Now the rating is locked and the setting cannot be changed unless you enter the correct password.

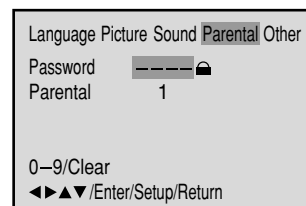

5 Press **SET UP** or **RETURN** to exit the parental control screen.

To change the parental level

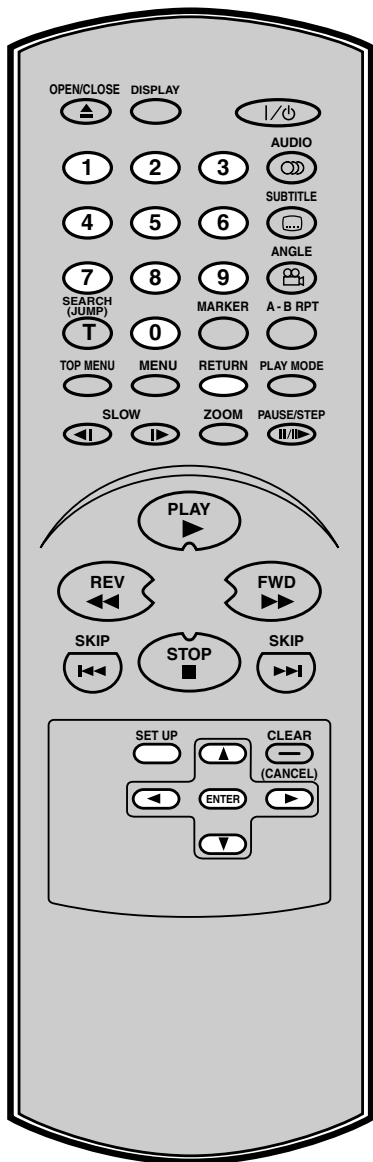

1 Press **SET UP** from the stop mode.

Press ◀ or ▶ to select "Parental". Then press ▼ or **ENTER**.

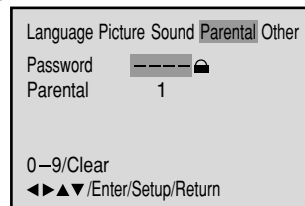

2 Press **number buttons (0-9)** to enter the password you have stored.

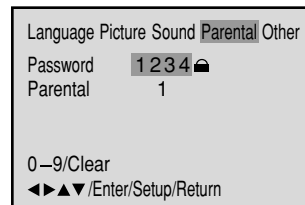

3 Press **ENTER**.
The rating is now unlocked.

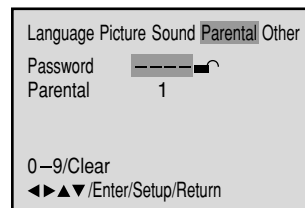

4 Press ▲ or ▼ to select "Parental", then press ◀ or ▶ to change the parental level.

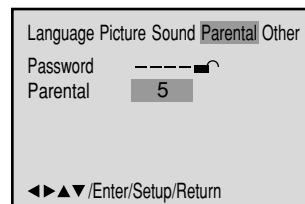

5 Press ▲ or ▼ to select "Password", then press **number buttons (0-9)** to enter the password.

Note: You can change the password at this time if you want.

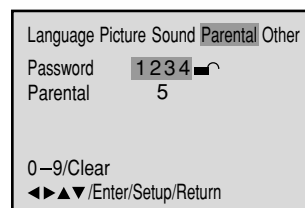

6 Press **ENTER**.
The parental level is changed and locked.

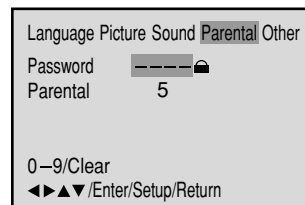

7 Press **SET UP** or **RETURN** to exit the parental control screen.

If you forget the password...

1. Press **OPEN/CLOSE** to open the disc tray.
2. Remove the disc.
3. Press **OPEN/CLOSE** again to close the tray. "No Disc" appears on the TV screen.
4. While holding **STOP** down on the front panel, press **7** on the remote control. "PASSWORD CLEAR" appears on the TV screen.
5. Enter a new password again.

Temporary disabling of rating level of DVD disc

Some DVD discs may permit you to temporarily cancel the rating level that you have set. It is up to you to decide whether or not to cancel the rating level.

- 1 Load a DVD disc and press **PLAY** or **OPEN/CLOSE** on the unit (see P.21).

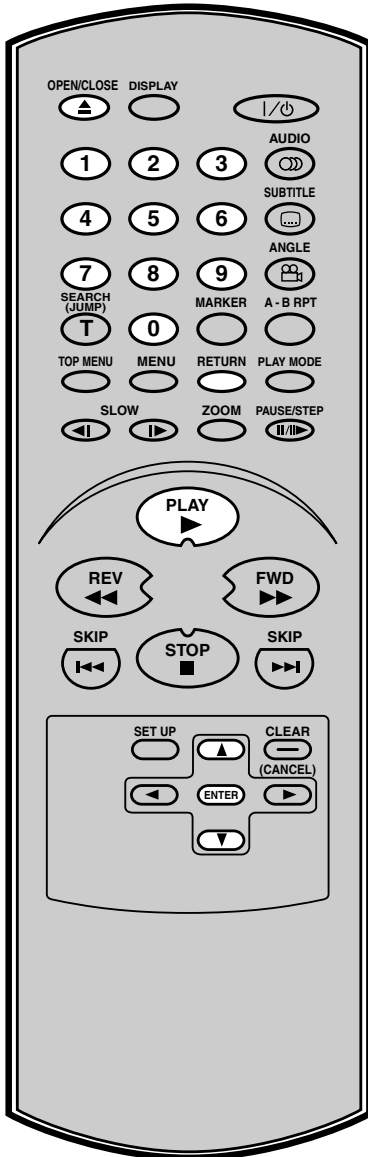
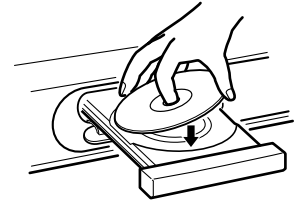

- 2 If the DVD disc has been designed to temporarily cancel the Rating level, the screen which follows the "Reading" screen will change, depending on which disc is played. If you select "YES" with the SELECT key, "Your disc exceeds the parental control level#." screen will then appear.

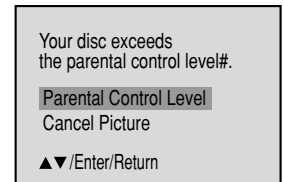
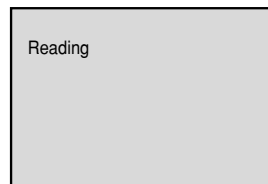

- 3 If you wish to cancel the set rating level temporarily, select "Parental Control Level" with ▲ or ▼, then press **ENTER**. If the 4-digit password at step 3 on P.33 has been set, the password entering screen will appear as shown in step 4 below.

Alternatively, if the password has not been set, playback will commence. If you don't know (or have forgotten) the password, select "Cancel Picture".

The setting screen will disappear. Press **OPEN/CLOSE** to remove the disc.

- 4 Enter the password with **number buttons (0-9)**. Then press **ENTER**.

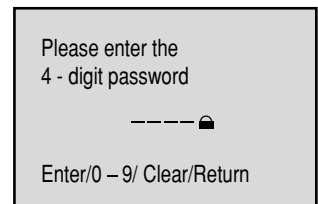

If you interrupt the entering, press **RETURN**.

- 5 Playback will commence if the entered password was correct.

Note:

This temporary cancellation of rating level will be maintained until the disc is ejected. When the disc is ejected, the original rating level will be set again automatically.

Setting menu language

You can select the language of the DVD disc menu display.

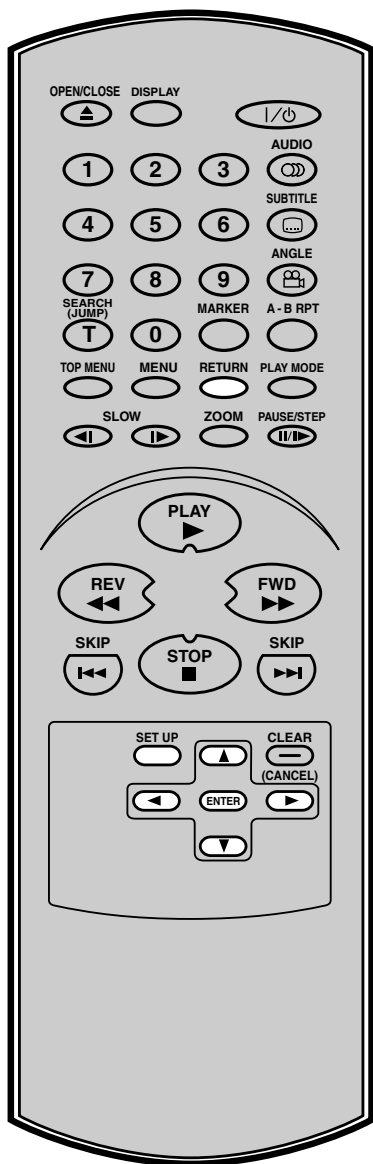

- 1 Press **SET UP** from the stop mode.
Press ◀ or ▶ to select "Language".

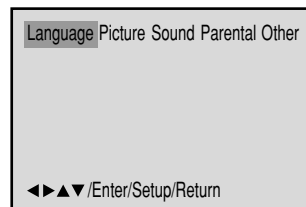

- 2 Press ▼ or **ENTER**, then press ▲ or ▼ to select "Menu".

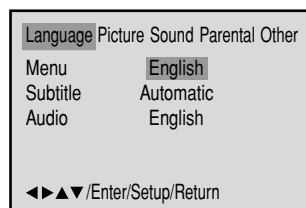

- 3 Press ▶ or **ENTER**.
Press ▲ or ▼ to select your desired language, then press **ENTER**.

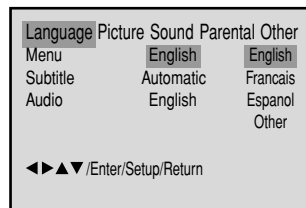

English, Francais, Espanol:

The selected language is the first-priority Menu language.

Other: Other language can be selected (See the Language Code List on page 39).

- 4 To exit the SETUP screen, press **SET UP** or **RETURN** while the SETUP screen is displayed.

Setting subtitle language

The same subtitle language can always be selected even if you replace the disc or turn the power off.

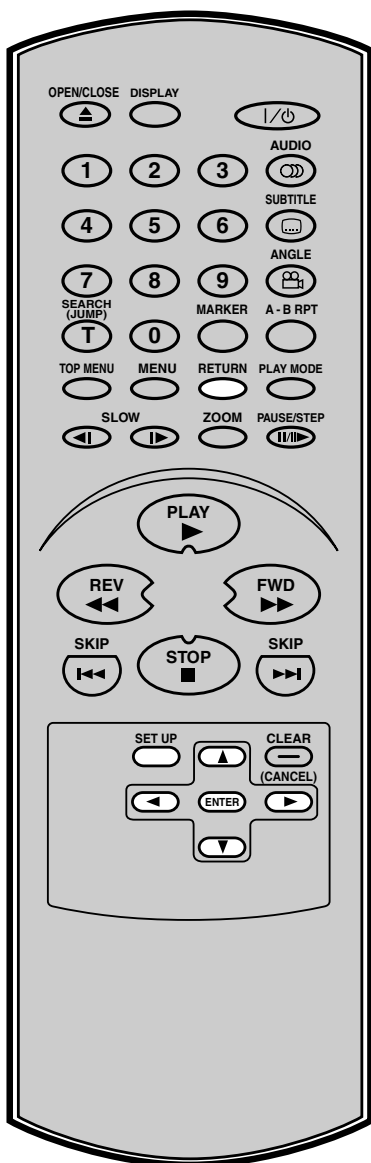

Note:

If the selected language is not recorded on the disc, the first-priority language is selected.

1 Press **SET UP** from the stop mode. Press ◀ or ▶ to select "Language".

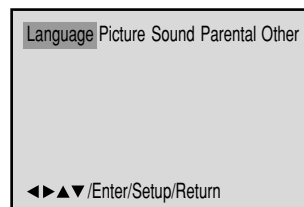

2 Press ▼ or **ENTER**, then press ▲ or ▼ to select "Subtitle".

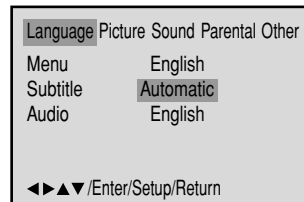

3 Press ▶ or **ENTER**. Press ▲ or ▼ to select your desired language, then press **ENTER**.

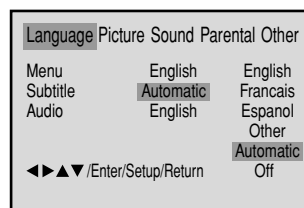

English, Francais, Espanol:

The subtitle is displayed with the selected language if it is recorded on the disc.

Other:

If you want to select another language, enter the language code (see the language code list on page 39).

Automatic:

- The unit will automatically select the same language chosen for the AUDIO setting.
- When the same language as the AUDIO is recorded on the disc, the subtitles will not appear during playback.
- When the same language as the AUDIO is not recorded on the disc, the subtitles will appear during playback.

Off:

Subtitles do not appear.

4 To exit the SETUP screen, press **SET UP** or **RETURN** while the SETUP screen is displayed.

Setting audio soundtrack language

The same audio soundtrack language can always be selected by your unit even if you replace the disc or turn the power off.

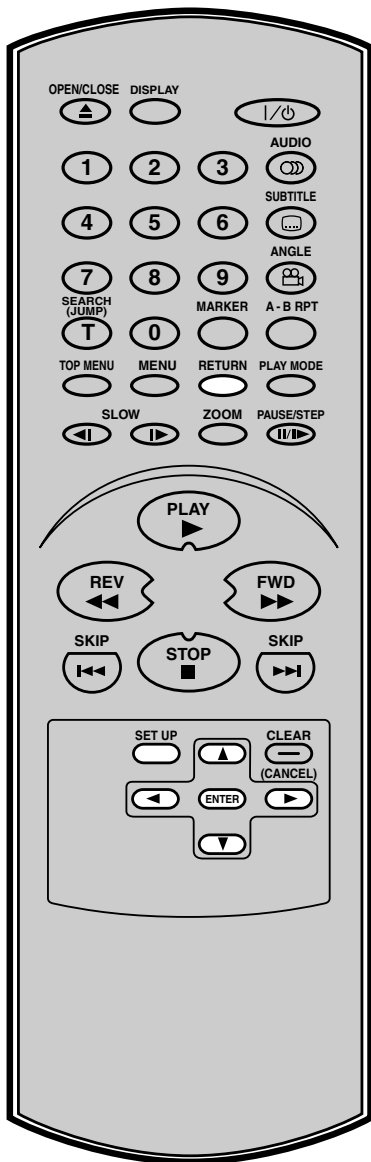

- 1 Press **SET UP** from the stop mode. Press ◀ or ▶ to select "Language".

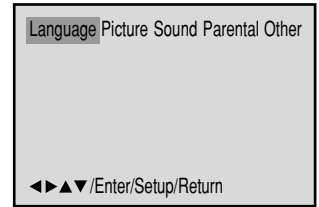

- 2 Press ▼ or **ENTER**, then press ▲ or ▼ to select "Audio".

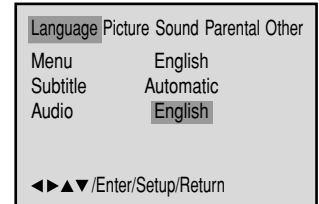

- 3 Press ▶ or **ENTER**. Press ▲ or ▼ to select your desired Audio Language, then press **ENTER**.

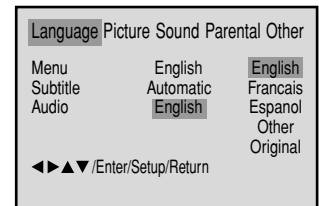

- **English, Francais, Espanol:** The language you have selected will play if it is recorded on the disc.
- **Other:** If you want to select another language, enter the language code (See the Language Code List on page 39).
- **Original:** The unit will select the first priority language of each disc.

- 4 To exit the SETUP screen, press **SET UP** or **RETURN** while the SETUP screen is displayed.

Note:

If the selected language is not recorded on the disc, the original language will be heard.

Language code list

Enter the appropriate code number for the initial settings "AUDIO", "SUBTITLE" and/or "MENU LANGUAGE" (see pages 36-38).

Language Name	Code	Language Name	Code	Language Name	Code	Language Name	Code
Abkhazian	1112	Fiji	1620	Lingala	2224	Singhalese	2919
Afar	1111	Finnish	1619	Lithuanian	2230	Slovak	2921
Afrikaans	1116	French	1628	Macedonian	2321	Slovenian	2922
Albanian	2927	Frisian	1635	Malagasy	2317	Somali	2925
Amharic	1123	Galician	1722	Malay	2329	Spanish	1529
Arabic	1128	Georgian	2111	Malayalam	2322	Sundanese	2931
Armenian	1835	German	1415	Maltese	2330	Swahili	2933
Assamese	1129	Greek	1522	Maori	2319	Swedish	2932
Aymara	1135	Greenlandic	2122	Marathi	2328	Tagalog	3022
Azerbaijani	1136	Guarani	1724	Moldavian	2325	Tajik	3017
Bashkir	1211	Gujarati	1731	Mongolian	2324	Tamil	3011
Basque	1531	Hausa	1811	Nauru	2411	Tatar	3030
Bengali; Bangla	1224	Hebrew	1933	Nepali	2415	Telugu	3015
Bhutani	1436	Hindi	1819	Norwegian	2425	Thai	3018
Bihari	1218	Hungarian	1831	Oriya	2528	Tibetan	1225
Breton	1228	Icelandic	1929	Panjabi	2611	Tigrinya	3019
Bulgarian	1217	Indonesian	1924	Pashto, Pushto	2629	Tonga	3025
Burmese	2335	Interlingua	1911	Persian	1611	Turkish	3028
Byelorussian	1215	Irish	1711	Polish	2622	Turkmen	3021
Cambodian	2123	Italian	1930	Portuguese	2630	Twi	3033
Catalan	1311	Japanese	2011	Quechua	2731	Ukrainian	3121
Chinese	3618	Javanese	2033	Rhaeto-Romance	2823	Urdu	3128
Corsican	1325	Kannada	2124	Romanian	2825	Uzbek	3136
Croatian	1828	Kashmiri	2129	Russian	2831	Vietnamese	3219
Czech	1329	Kazakh	2121	Samoan	2923	Volapük	3225
Danish	1411	Kirghiz	2135	Sanskrit	2911	Welsh	1335
Dutch	2422	Korean	2125	Scots Gaelic	1714	Wolof	3325
English	1524	Kurdish	2131	Serbian	2928	Xhosa	3418
Esperanto	1525	Laothian	2225	Serbo-Croatian	2918	Yiddish	2019
Estonian	1530	Latin	2211	Shona	2924	Yoruba	3525
Faroese	1625	Latvian, Lettish	2232	Sindhi	2914	Zulu	3631

Before Calling Service Personnel

Check the following guide for the possible cause of a problem before contacting service.

Symptoms and correction

Symptom	Cause	Correction	Page
No power.	<ul style="list-style-type: none"> The power plug is disconnected. 	<ul style="list-style-type: none"> Connect the power plug securely into the wall outlet. 	16
No picture.	<ul style="list-style-type: none"> The TV is not set to receive DVD signal output. 	<ul style="list-style-type: none"> Select the appropriate video input mode on the TV so the picture from the DVD video player appears on the TV screen. 	—
	<ul style="list-style-type: none"> The video cable is not connected securely. 	<ul style="list-style-type: none"> Connect the video cable securely into the appropriate jacks. 	16, 17
No sound.	<ul style="list-style-type: none"> The equipment connected with the audio cable is not set to receive DVD signal output. 	<ul style="list-style-type: none"> Select the correct input mode of the audio receiver so you can listen to the sound from the DVD video player. 	—
	<ul style="list-style-type: none"> The audio cable is not connected securely. 	<ul style="list-style-type: none"> Connect the audio cable securely into the appropriate jacks. 	16, 17 18, 19
	<ul style="list-style-type: none"> The audio receiver or TV is turned off. 	<ul style="list-style-type: none"> Turn on the equipment connected with the audio cable. 	—
	<ul style="list-style-type: none"> The unit is in the special playback mode. 	<ul style="list-style-type: none"> Resume the normal playback. 	22
The playback picture has occasional distortion.	<ul style="list-style-type: none"> The disc is dirty. 	<ul style="list-style-type: none"> Eject the disc and clean it. 	9
	<ul style="list-style-type: none"> It is in fast forward or fast reverse playback. 	<ul style="list-style-type: none"> Sometimes a small amount of picture distortion may appear. This is not a malfunction. 	—
Brightness is unstable or noises are present in the playback pictures.	<ul style="list-style-type: none"> The effect of copy protection. 	<ul style="list-style-type: none"> Connect the DVD video player directly to the TV. Avoid connecting the DVD video player to a VCR or TV/VCR combination. 	16
The DVD video player does not start playback.	<ul style="list-style-type: none"> No disc is inserted. 	<ul style="list-style-type: none"> Insert a disc. 	21
	<ul style="list-style-type: none"> An unplayable disc is inserted. 	<ul style="list-style-type: none"> Insert a playable disc. (Check the disc type and color system.) 	10
	<ul style="list-style-type: none"> The disc is placed upside down. 	<ul style="list-style-type: none"> Place the disc with the playback side down. 	21
	<ul style="list-style-type: none"> The disc is not placed within the guide. 	<ul style="list-style-type: none"> Place the disc correctly inside the guide on the disc tray. 	21
	<ul style="list-style-type: none"> The disc is dirty. 	<ul style="list-style-type: none"> Clean the disc. 	9
	<ul style="list-style-type: none"> The parental lock function is set. 	<ul style="list-style-type: none"> Cancel the parental lock function or change the parental lock level. 	34
	<ul style="list-style-type: none"> ⚡ appears on the screen. 	<ul style="list-style-type: none"> The function is prohibited with the unit or the disc. 	10
Playback does not follow the course of the disc's program.	<ul style="list-style-type: none"> It is in the mode of repeat playback, program playback, etc. 	<ul style="list-style-type: none"> These operations may prevent a proper progress of the contents. 	—
Buttons do not work.	<ul style="list-style-type: none"> Power supply fluctuations or other abnormalities such as static electricity may interrupt correct operations. 	<ul style="list-style-type: none"> Turn the power on or off with POWER. Or disconnect the power plug and insert it into the wall outlet again. 	—
The remote control does not work properly.	<ul style="list-style-type: none"> The remote control is not pointed at the remote sensor of the DVD video player. 	<ul style="list-style-type: none"> Point the remote control at the remote sensor of the DVD video player. 	15
	<ul style="list-style-type: none"> The remote control is too far from the DVD video player. 	<ul style="list-style-type: none"> Operate the remote control within about 7 m. 	15
	<ul style="list-style-type: none"> The batteries in the remote control are exhausted. 	<ul style="list-style-type: none"> Replace the batteries with new ones. 	15

DVD video player / outputs / supplied accessories

DVD Video Player

Power supply	120 V AC, 60 Hz
Power consumption	Operation : 10 W Standby : 4 W
Mass	4.4 lbs (2.0 kg)
External dimensions	Width : 16 - 15/16 inches (430mm) Height : 2 - 5/16 inches (59mm) Depth : 8 - 1/8 inches (206.5mm)
Signal system	Standard NTSC
Pickup	CD : Wavelength: 775 - 815 nm Maximum output power: 0.5 mW DVD : Wavelength: 650 - 666 nm Maximum output power: 2.0 mW
Frequency response	DVD : 4 Hz - 22 kHz CD : 4 Hz - 20 kHz
Harmonic distortion	0.008 %
Wow and flutter	Below measurable level
Operating conditions	Temperature: 5 °C to 40 °C, Operation status: Horizontal

Outputs

Video output	1.0 V (p-p), 75 Ω, negative sync., pin jack × 1
S video output	(Y) 1.0 V (p-p), 75 Ω, negative sync., Mini DIN 4-pin × 1 (C) 0.286 V (p-p), 75 Ω
Component video output	(Y) 1.0 V (p-p), 75 Ω, negative sync., pin jack × 1 (P _B)/(P _R) 0.7 V (p-p), 75 Ω, pin jack × 2
Audio output (BITSTREAM/PCM COAXIAL)	0.5V (p-p), 75 Ω, pin jack × 1
Audio output (BITSTREAM/PCM OPTICAL)	Optical connector × 1
Audio output (ANALOG)	2.0 V (rms), 220 Ω, pin jacks (L, R) × 1

Supplied Accessories

Audio/video cable	1
Remote control	1
Batteries (AAA)	2

• Designs and specifications are subject to change without notice.

LIMITED WARRANTY DVD VIDEO PLAYER

Toshiba America Consumer Products, Inc. ("TACP"), Toshiba Hawaii ("THI") and Toshiba Canada Limited ("TCL") make the following limited warranties. These limited warranties extend to original purchaser or any person receiving this set as a gift from the original purchaser and to no other purchaser or transferee.

Limited Ninety (90) Day Warranty

TACP/THI warrant this product against defects in materials or workmanship for a period of ninety (90) days after the date of original retail purchase. During this period, TACP/THI will repair or replace a defective product or part, at their option, with a new or refurbished product or part without charge to you. You must deliver the entire product to a TACP/THI Authorized Service Station. You are responsible for all transportation and insurance charges for the unit to and from the Authorized Service Station. If you live in the U.S.A. you may, at your option, return your DVD Unit to:

Toshiba America Consumer Products Inc.
Returns Center
1420C Toshiba Dr.
Lebanon, TN 37087

Upon receipt we will, at our option, exchange the DVD Unit with a new or refurbished unit. **Canadian consumers are requested to contact TCL. In Hawaii consumers are requested to contact THI.**

Limited One (1) Year Warranty

TACP/THI further warrant the parts in this product against defects in materials or workmanship for a period of one (1) year after the date of original retail purchase. During this period, TACP/THI will repair or replace a defective product or part, at their option, with a new or refurbished product or part without charge to you, except that if a defective part is replaced after ninety (90) days from the date of the original retail purchase you pay labor charges involved in the replacement. You must also deliver the entire product to a TACP/THI Authorized Service Station. You are responsible for all transportation and insurance charges for the unit to and from the Authorized Service Station. If you live in the U.S.A. you may, at your option, return your DVD Unit to:

Toshiba America Consumer Products Inc.
Returns Center
1420C Toshiba Dr.
Lebanon, TN 37087

Upon receipt we will, at our option, exchange the DVD Unit with a new or refurbished unit. **Canadian Consumers are requested to contact TCL. In Hawaii consumers are requested to contact THI.**

Rental Units

The warranty for rental units begin with the first rental or thirty (30) days from the date of shipment to the rental firm, whichever comes first.

Commercial Units

Products sold and used for commercial use have a limited ninety (90) day warranty for all parts and labor.

Owner's Manual

You should read the owner's manual thoroughly before operating this product. You should complete and mail the enclosed Demographic card within ten (10) days after you, or the person who has given you this product as a gift, purchased this product. This is one way to enable TACP to provide you with better customer service and improved products. Failure to return the card will not affect your rights under this warranty.

Your Responsibility

The above warranties are subject to the following conditions:

- (1) You must retain your bill of sale or provide other proof of purchase.
- (2) You must notify a TACP/THI/TCL /Authorized Service Station within thirty (30) days after you discover a defective product or part.
- (3) All warranty servicing of this product must be made by a TACP/THI/TCL Authorized Service Station.
- (4) U.S.A. warranties are effective only if the product is purchased and operated in the Continental U.S.A. or Puerto Rico.
- (5) Labor service charges for set installation. Set up, adjustment of customer controls and installation or repair of antenna systems are not covered by this warranty. Reception problems caused by inadequate antenna systems are your responsibility.
- (6) Warranties extend only to defects in materials or workmanship as limited above and do not extend to any product or parts which have been lost or discarded by you or to damage to products or parts caused by misuse, accident, damage caused by Acts of God, such as lighting or fluctuations in electric power, improper installation, improper maintenance or use in violation of instructions furnished by us; or to units which have been altered or modified without authorization of TACP/THI/TCL or to damage to products or part thereof which have had the serial number removed, altered, defaced or rendered illegible.
- (7) Should you elect to return your DVD Unit to TACP after the ninety (90) days and within one (1) year, or after the warranty period has expired: Call (800)-631-3811 to receive information concerning an exchange price. Payment must be enclosed with product in the form of a certified check or money order including reason for return.
- (8) Physically damaged DVD Units are not acceptable for repair or exchange whether in or out of warranty and will be returned as received.

(Continued)

LIMITED WARRANTY DVD VIDEO PLAYER (continued)

How to Obtain Warranty Service

- (1) Refer to the troubleshooting guide in your owner's manual. This check list may solve your problem.
- (2) In the U.S.A., only call the TACP toll free number 800-631-3811, or if in Hawaii or Canada see listing below within (30) days after you find a defective product or part.
- (3) Arrange for the delivery of the product to the TACP/THI/TCL Authorized Service Station or TACP Return Center. Products shipped to the Service Station must be insured and safely and securely packed, preferably in the original shipping carton, and a letter explaining the defect and also a copy of the bill of sale or other proof of purchase must be enclosed.

In the Continental United States contact:



In Hawaii contact:

Toshiba Hawaii Inc.
327 Kamakee Street
Honolulu, HA 96814
(808)-521-5377

In Canada contact:

Consumer Electronics Group
191 McNabb Street
Markham, Ontario L3R 8H2
(905)-470-5400

Consumer Electronics Group
22171 Fraserwood Way
Richmond, B.C. V6W 1J5
(604)-303-2500

Consumer Electronics Group
18050 Trans canada
Kirkland, Quebec H9J 4A1
(514)-390-7766

All warranties implied by state law, including the implied warranties of merchantability and fitness for a particular purpose, are expressly limited to the duration of the limited warranties set forth above. With the exception of any warranties implied by state law as hereby limited, the foregoing warranty is exclusive and in lieu of all other warranties, guarantees, agreements and similar obligations of manufacturer or seller with respect to the repair or replacement of any parts. In no event shall TACP/THI be liable for consequential or incidental damages.

No person, agent, distributor, dealer or company is authorized to change, modify or extend the terms of these warranties in any manner whatsoever. The time within which an action must be commenced to enforce any obligation of TACP/THI arising under the warranty or under any statute, or law of the United States or any state thereof, is hereby limited to ninety (90) days from the date you discover or should have discovered, the defect. This limitation does not apply to implied warranties arising under state law.

This warranty gives you specific legal rights and you may also have other rights which may vary from state to state. Some states do not allow limitation on how long an implied warranty lasts, when an action may be brought, or the exclusion or limitation of incidental or consequential damages, so the above provisions may not apply to you.

ATTENTION CANADIAN CONSUMERS:

Canadian consumers are requested to complete the special Canadian "Warranty Registration Form" enclosed, and forward this completed form with a copy of bill of sale to TOSHIBA OF CANADA to "Register and Validate" their warranty. Product must be purchased from an Authorized Canadian Dealer. Products purchased in the U.S.A. and used in Canada are not covered by these warranties.

IMPORTANT: PACKING AND SHIPPING INSTRUCTION

When you send the product to a Service Station, you must use the original carton box and packing material, then insert the original carton box containing the unit into another carton using more packing material.

TOSHIBA

TOSHIBA AMERICA CONSUMER PRODUCTS, INC.