

DENON

CD AUTO CHANGER

DCM-390

OPERATING INSTRUCTIONS

■ SAFETY PRECAUTIONS



CAUTION

RISK OF ELECTRIC SHOCK

DO NOT OPEN



CAUTION:
TO REDUCE THE RISK OF ELECTRIC SHOCK, DO NOT REMOVE COVER (OR BACK). NO USER-SERVICEABLE PARTS INSIDE. REFER SERVICING TO QUALIFIED SERVICE PERSONNEL.

The lightning flash with arrowhead symbol, within an equilateral triangle, is intended to alert the user to the presence of uninsulated "dangerous voltage" within the product's enclosure that may be of sufficient magnitude to constitute a risk of electric shock to persons.

The exclamation point within an equilateral triangle is intended to alert the user to the presence of important operating and maintenance (servicing) instructions in the literature accompanying the appliance.

WARNING:
TO REDUCE THE RISK OF FIRE OR ELECTRIC SHOCK, DO NOT EXPOSE THIS APPLIANCE TO RAIN OR MOISTURE.

LABELS (for U.S.A. model only)

CERTIFICATION

THIS PRODUCT COMPLIES WITH DHHS RULES 21CFR SUBCHAPTER J APPLICABLE AT DATE OF MANUFACTURE.

CAUTION:
USE OF CONTROLS OR ADJUSTMENTS OR PERFORMANCE OF PROCEDURES OTHER THAN THOSE SPECIFIED HEREIN MAY RESULT IN HAZARDOUS RADIATION EXPOSURE.
THE COMPACT DISC PLAYER SHOULD NOT BE ADJUSTED OR REPAIRED BY ANYONE EXCEPT PROPERLY QUALIFIED SERVICE PERSONNEL.

SAFETY INSTRUCTIONS

1. Read Instructions – All the safety and operating instructions should be read before the product is operated.
2. Retain Instructions – The safety and operating instructions should be retained for future reference.
3. Heed Warnings – All warnings on the product and in the operating instructions should be adhered to.
4. Follow Instructions – All operating and use instructions should be followed.
5. Cleaning – Unplug this product from the wall outlet before cleaning. Do not use liquid cleaners or aerosol cleaners.
6. Attachments – Do not use attachments not recommended by the product manufacturer as they may cause hazards.
7. Water and Moisture – Do not use this product near water – for example, near a bath tub, wash bowl, kitchen sink, or laundry tub; in a wet basement; or near a swimming pool; and the like.
8. Accessories – Do not place this product on an unstable cart, stand, tripod, bracket, or table. The product may fall, causing serious injury to a child or adult, and serious damage to the product. Use only with a cart, stand, tripod, bracket, or table recommended by the manufacturer, or sold with the product. Any mounting of the product should follow the manufacturer's instructions, and should use a mounting accessory recommended by the manufacturer.
9. A product and cart combination should be moved with care. Quick stops, excessive force, and uneven surfaces may cause the product and cart combination to overturn.
10. Ventilation – Slots and openings in the cabinet are provided for ventilation and to ensure reliable operation of the product and to protect it from overheating, and these openings must not be blocked or covered. The openings should never be blocked by placing the product on a bed, sofa, rug, or other similar surface. This product should not be placed in a built-in installation such as a bookcase or rack unless proper ventilation is provided or the manufacturer's instructions have been adhered to.
11. Power Sources – This product should be operated only from the type of power source indicated on the marking label. If you are not sure of the type of power supply to your home, consult your product dealer or local power company. For products intended to operate from battery power, or other sources, refer to the operating instructions.
12. Grounding or Polarization – This product may be equipped with a polarized alternating-current line plug (a plug having one blade wider than the other). This plug will fit into the power outlet only one way. This is a safety feature. If you are unable to insert the plug fully into the outlet, try reversing the plug. If the plug should still fail to fit, contact your electrician to replace your obsolete outlet. Do not defeat the safety purpose of the polarized plug.



13. Power-Cord Protection – Power-supply cords should be routed so that they are not likely to be walked on or pinched by items placed upon or against them, paying particular attention to cords at plugs, convenience receptacles, and the point where they exit from the product.
15. Outdoor Antenna Grounding – If an outside antenna or cable system is connected to the product, be sure the antenna or cable system is grounded so as to provide some protection against voltage surges and built-up static charges. Article 810 of the National Electrical Code, ANSI/NFPA 70, provides information with regard to proper grounding of the mast and supporting structure, grounding of the lead-in wire to an antenna discharge unit, size of grounding conductors, location of antenna-discharge unit, connection to grounding electrodes, and requirements for the grounding electrode. See Figure A.
16. Lightning – For added protection for this product during a lightning storm, or when it is left unattended and unused for long periods of time, unplug it from the wall outlet and disconnect the antenna or cable system. This will prevent damage to the product due to lightning and power-line surges.
17. Power Lines – An outside antenna system should not be located in the vicinity of overhead power lines or other electric light or power circuits, or where it can fall into such power lines or circuits. When installing an outside antenna system, extreme care should be taken to keep from touching such power lines or circuits as contact with them might be fatal.
18. Overloading – Do not overload wall outlets, extension cords, or integral convenience receptacles as this can result in a risk of fire or electric shock.
19. Object and Liquid Entry – Never push objects of any kind into this product through openings as they may touch dangerous voltage points or short-out parts that could result in a fire or electric shock. Never spill liquid of any kind on the product.
20. Servicing – Do not attempt to service this product yourself as opening or removing covers may expose you to dangerous voltage or other hazards. Refer all servicing to qualified service personnel.
21. Damage Requiring Service – Unplug this product from the wall outlet and refer servicing to qualified service personnel under the following conditions:
 - a) When the power-supply cord or plug is damaged,
 - b) If liquid has been spilled, or objects have fallen into the product,
 - c) If the product has been exposed to rain or water,
 - d) If the product does not operate normally by following the operating instructions. Adjust only those controls that are covered by the operating instructions as an improper adjustment of other controls may result in damage and will often require extensive work by a qualified technician to restore the product to its normal operation,
 - e) If the product has been dropped or damaged in any way, and
 - f) When the product exhibits a distinct change in performance – this indicates a need for service.
22. Replacement Parts – When replacement parts are required, be sure the service technician has used replacement parts specified by the manufacturer or have the same characteristics as the original part. Unauthorized substitutions may result in fire, electric shock, or other hazards.
23. Safety Check – Upon completion of any service or repairs to this product, ask the service technician to perform safety checks to determine that the product is in proper operating condition.
24. Wall or Ceiling Mounting – The product should be mounted to a wall or ceiling only as recommended by the manufacturer.
25. Heat – The product should be situated away from heat sources such as radiators, heat registers, stoves, or other products (including amplifiers) that produce heat.

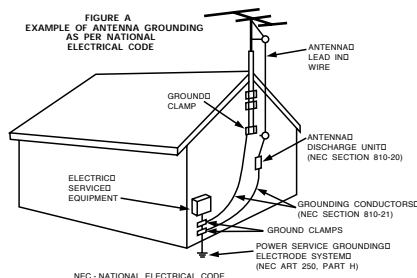

FCC INFORMATION (For US customers)

1. PRODUCT

This product complies with Part 15 of the FCC Rules. Operation is subject to the following two conditions: (1) this product may not cause harmful interference, and (2) this product must accept any interference received, including interference that may cause undesired operation.

2. IMPORTANT NOTICE: DO NOT MODIFY THIS PRODUCT

This product, when installed as indicated in the instructions contained in this manual, meets FCC requirements. Modification not expressly approved by DENON may void your authority, granted by the FCC, to use the product.

3. NOTE

This product has been tested and found to comply with the limits for a Class B digital device, pursuant to Part 15 of the FCC Rules. These limits are designed to provide reasonable protection against harmful interference in a residential installation.

This product generates, uses and can radiate radio frequency energy and, if not installed and used in accordance with the instructions, may cause harmful interference to radio communications. However, there is no guarantee that interference will not occur in a particular installation. If this product does cause harmful interference to radio or television reception, which can be determined by turning the product OFF and ON, the user is encouraged to try to correct the interference by one or more of the following measures:

- Reorient or relocate the receiving antenna.
- Increase the separation between the equipment and receiver.
- Connect the product into an outlet on a circuit different from that to which the receiver is connected.
- Consult the local retailer authorized to distribute this type of product or an experienced radio/TV technician for help.







This Class B apparatus complies with Canadian ICES-003.

Cet appareil numérique de la classe B est conforme à la norme NMB-003 du Canada.

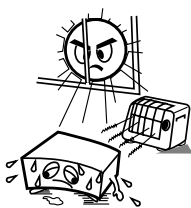
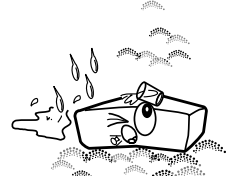
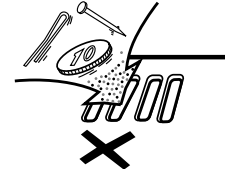
Copyrights

- It is prohibited by law to reproduce, broadcast, rent or play discs in public without the consent of the copyright holder.
- La reproduction, la diffusion, la location, le prêt ou la lecture publique de ces disques sont interdits sans le consentement du détenteur des droits d'auteur.
- De acuerdo con las leyes está prohibido reproducir, emitir, alquilar o interpretar discos en público sin la autorización del propietario de los derechos de autor.

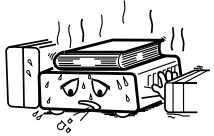
NOTE ON USE

 <ul style="list-style-type: none"> • Avoid high temperatures. Allow for sufficient heat dispersion when installed in a rack. 	 <ul style="list-style-type: none"> • Keep the apparatus free from moisture, water, and dust. 	 <ul style="list-style-type: none"> • Do not let foreign objects into the apparatus.
 <ul style="list-style-type: none"> • Unplug the power cord when not using the apparatus for long periods of time. 	 <ul style="list-style-type: none"> • Do not let insecticides, benzene, and thinner come in contact with the apparatus. 	
 <ul style="list-style-type: none"> • Handle the power cord carefully. Hold the plug when unplugging the cord. 	 <p>* (For apparatuses with ventilation holes)</p> <ul style="list-style-type: none"> • Do not obstruct the ventilation holes. 	
		 <ul style="list-style-type: none"> • Never disassemble or modify the apparatus in any way.

Getting Started

Thank you for purchasing this DENON CD Player. Please read the operation instructions thoroughly in order to acquaint yourself with the CD player and achieve maximum satisfaction from it. Be sure to keep these instructions for future reference, should any questions or problems arise.

Contents

Getting Started	
Accessories	1
Before using	1, 2
About discs	
Discs usable on this set	2
Before playing MP3 or WMA (Windows Media® Audio) files	2
Holding discs	2
Loading discs	2
Cautions on loading discs	3
Cautions on handling	3
Cautions on storing discs	3
Cleaning discs	3
About the remote control unit	
Inserting the batteries	3
Operating range of the remote control unit	3
Part names and functions	
Front panel	4
Display	4
Rear panel	5
Remote control unit	5
Connections	
Cable indications	6
Analog connections	6
Digital connections	6
Connecting the power supply cord	6

Operation	
Turning the power on	7
Opening and closing the drawer and loading a disc	7
Starting playback	8
To stop playback	8
Various playback functions	
Playing the desired disc and desired track [Direct play]	8
To move to the next disc during playback	8
To pause playback	8
Automatic search	8
Manual search	9
Programmed play	9
Random play	10
Repeat play	10
Other functions	10

Troubleshooting	11
-----------------	----

Specifications	12
----------------	----

Accessories

Check that the following parts are attached in addition to the main unit:

① Operating instructions	1
② Service station list	1
③ Remote control unit (RC-1033)	1
④ R03/AAA batteries	2
⑤ Pin-plug cable (Cable length: Approx. 39-3/8 ft 1 m)	1
⑥ Power supply cord (Cable length: Approx. 78-47/64 ft 2 m)	1

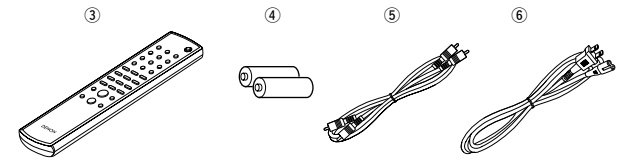

Before using

Remove two shipping screws.

At the bottom of the player there are two red shipping screws for use when the player is transported. Before using the player, turn these screws counterclockwise and remove them. If the shipping screws are still in place and the power is turned on, the disc tray will not open. If this happens, turn off the power, unplug the power supply cord from the power outlet and remove the shipping screws. Retain these screws as they will be needed when the player is transported.

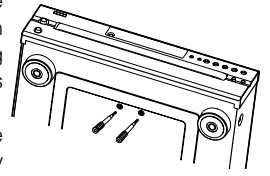

Before transporting the player, take out the discs, close the disc tray, turn off the power after "0 000 00:00" is displayed and unplug the power supply cord from the power outlet. Then install the shipping screws by turning them clockwise. Be sure to fasten them securely.

Handle the power supply cord carefully.

Do not damage or deform the power supply cord. If it is damaged or deformed, it may cause electric shock or malfunction when used. When disconnecting the power supply cord from the wall outlet, hold the plug and do not pull on the cable.

Do not open the top cover.

In order to prevent electric shock, do not open the top cover. If problems occur, contact your DENON dealer.

Do not place anything inside.

Prevent metal objects from entering the CD player and avoid spilling liquids on it. Electric shock or malfunction may result.

Cautions on moving.

First, if a disc is loaded, eject it, then turn off the power, unplug the power supply cord from the power outlet and disconnect the connection cables with other devices.

Cautions on using mobile phones.

Using a mobile phone near this unit may result in noise. If so, move the mobile phone away from this unit when using it.

Store these instructions in a safe place.

After reading, store this instructions along with the warranty card in a safe place.

Note that the illustrations in these instructions may differ from the actual unit for explanation purposes.

Getting Started

NOTE:

- This CD player uses a semiconductor laser. To ensure stable operation, it is recommended to use the set indoors at a temperature of 5°C (41°F) ~ 35°C (95°F).

About discs

Discs usable on this set

1 Music CDs

Discs with the mark at the right can be used on this set.

Note however that discs with special shapes (heart-shaped discs, octagonal discs, etc.) cannot be played. Do not attempt to play them, as doing so could damage the set.



2 CD-R/CD-RW

- Some discs and some recording formats may not be playable.
- Non-finalized discs cannot be played.

*** Finalization:**

Finalization is the process that makes recorded CD-R/CD-RW discs playable on compatible players.

Before playing MP3 or WMA (Windows Media® Audio) files

There are many music distribution sites on the Internet allowing you to download music files in MP3 or WMA format. The music (files) downloaded from such sites can be stored on CD-R or CD-RW discs and played on the this CD player.

“Windows Media” and “Windows” are registered trademarks or trademarks in the United States and other countries of the Microsoft Corporation of the United States.

*** According to copyright laws, recordings you have made should only be used for your personal enjoyment and must not be used in other ways without the consent of the copyright holder.**

NOTE:

- This CD player is compatible with “MPEG-1 Audio Layer-3” standards (sampling frequency of 44.1 and 48 kHz). It is not compatible with “MPEG-2 Audio Layer-3”, “MPEG-2.5 Audio Layer-3”, MP1 or MP2 standards.
- The signals are output with a sampling frequency of 44.1 kHz.
- When writing MP3 files on a CD-R or CD-RW disc, set the writing software’s format to “ISO9660 Level 1”. The files may not play properly if they are recorded in other formats. Also note that with some writing software it is not possible to record in ISO9660 format. If so, use a different program allowing you to record in ISO9660 format.
- With MP3 files, the higher the bit rate, the better the sound quality. The compatible bit rate range is 32 to 320 kbps for MP3 files, 64 to 160 kbps for WMA files. We recommend using MP3 files with bit rates of 128 kbps or greater on the this CD player.
- Be sure to add the extensions “.MP3” or “.WMA” to MP3 or WMA files, respectively. Files with extensions other than “.MP3” or “.WMA” or files without extensions cannot be played. (On Macintosh computers, MP3 files can be played by giving the extension “.MP3” after the file name consisting up a maximum of 8 alphanumeric characters and storing the files on a CD-R or CD-RW disc.)
- This CD player is not compatible with packet write software or playlists.
- The time may not be displayed properly when searching or pausing during variable bit rate playback.
- The time display cannot be switched “TOTAL REMAIN” using the **TIME** button on the remote control unit.

Getting Started

NOTE:

- Multisession and CD-R/CD-RW discs that have not been completely written can be played, but we recommend using discs closed after a maximum of 10 sessions or discs that have been completed.
- The maximum number of files and folders playable is 512 (total of the number of folders and files). The maximum number of folders is 256.
- Copyright-protected WMA files cannot be played. (“-- : --” is displayed. Use the **◀◀/▶▶** or **▶▶/▶▶** button on the main unit (the **◀◀** or **▶▶** button on the remote control unit) to select a different file.)

Holding discs

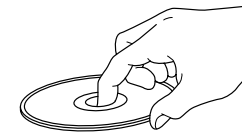

Do not touch the signal surface.

Loading discs

- Set the disc with the labeled side facing up.
- Make sure the disc tray is fully open when inserting the disc.
- Place the discs flatly, 12 cm discs in the outer tray guide (Figure 1), 8 cm discs in the inner tray guide (Figure 2).

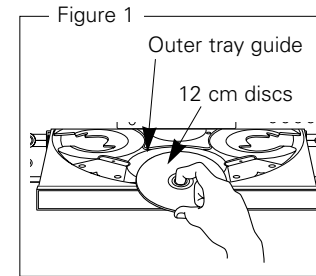

Figure 1

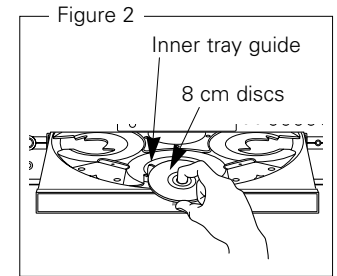

Figure 2

- Place 8 cm discs in the inner tray guide without using an adapter.



- “0 000 00:00” is displayed if no disc is loaded, if a disc that cannot be played is loaded or if the disc is loaded upside-down.

Getting Started

Cautions on loading discs

- Only load one disc per tray at a time. Loading two or more discs per tray can damage the set or scratch the discs.
- Do not use cracked or warped discs or discs that have been repaired with adhesive, etc.
- Do not use discs on which the sticky part of cellophane tape or labels is exposed or on which there are traces of where labels have been removed. Such discs could get caught inside the player and damage it.

Cautions on handling

- Do not get fingerprints, oil or dirt on discs.
- Take special care not to scratch discs when removing them from their cases.
- Do not bend or heat discs.
- Do not enlarge the hole at the center.
- Do not write on the labeled (printed) surface with ball-point pens, pencils, etc., or stick new labels on discs.
- Water droplets may form on discs if they are moved suddenly from a cold place (outdoors for example) to a warm place, but do not try to dry them off using a hairdryer, etc.

Cautions on storing discs

- Be sure to remove discs after using them.
- Be sure to store discs in their cases to protect them from dust, scratches, warping, etc.
- Do not store discs in the following places:
 1. Places exposed to direct sunlight for long periods of time
 2. Dusty or humid places
 3. Places exposed to heat from heating appliances, etc.

Cleaning discs

- If there are fingerprints or dirt on discs, wipe them off before using the disc. If not the sound quality could be reduced and the sound may be broken.
- Use a commercially available disc cleaning set or a soft cloth to clean discs.

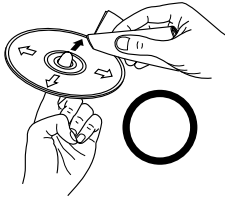

Gently wipe the disc from the inside towards the outside.

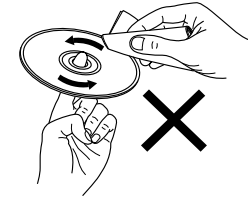

Do not wipe with a circular motion.

NOTE:

- Do not use record spray, antistatic agents, or benzene, thinner or other solvents.

About the remote control unit

Inserting the batteries

- ① Remove the remote control unit's rear cover.
- ② Set two R03/AAA batteries in the battery compartment in the indicated direction.

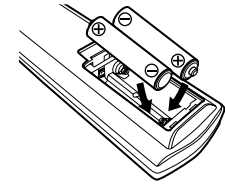
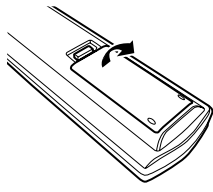

- ③ Put the rear cover back on.

Getting Started

Notes on batteries:

- Replace the batteries with new ones if the set does not operate even when the remote control unit is operated nearby the unit. (The attached batteries are only for verifying operation.)
- When inserting the batteries, be sure to do so in the proper direction, following the "⊕" and "⊖" marks in the battery compartment.
- To prevent damage or leakage of battery fluid:
 - Do not use a new battery together with an old one.
 - Do not use two different types of batteries.
 - Do not short-circuit, disassemble, heat or dispose of batteries in flames.
- If the battery fluid should leak, carefully wipe the fluid off the inside of the battery compartment and insert new batteries.
- Remove the batteries from the remote if it will not be in use for long periods.

Operating range of the remote control unit

- Point the remote control unit at the remote sensor when operating it.
- The remote control unit can be used from a distance of up to about 8 meters, at a horizontal angle of up to 30° with respect to the sensor.

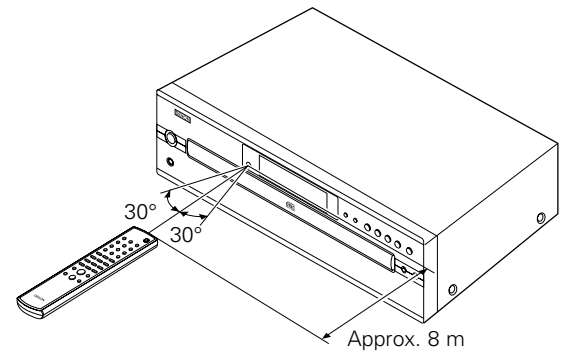

NOTE:

- It may be difficult to operate the remote control unit if the remote sensor is exposed to direct sunlight or strong artificial light.

Getting Started

Part names and functions

For buttons not explained here, see the page indicated in parentheses ().

Front panel

※ DCM-390

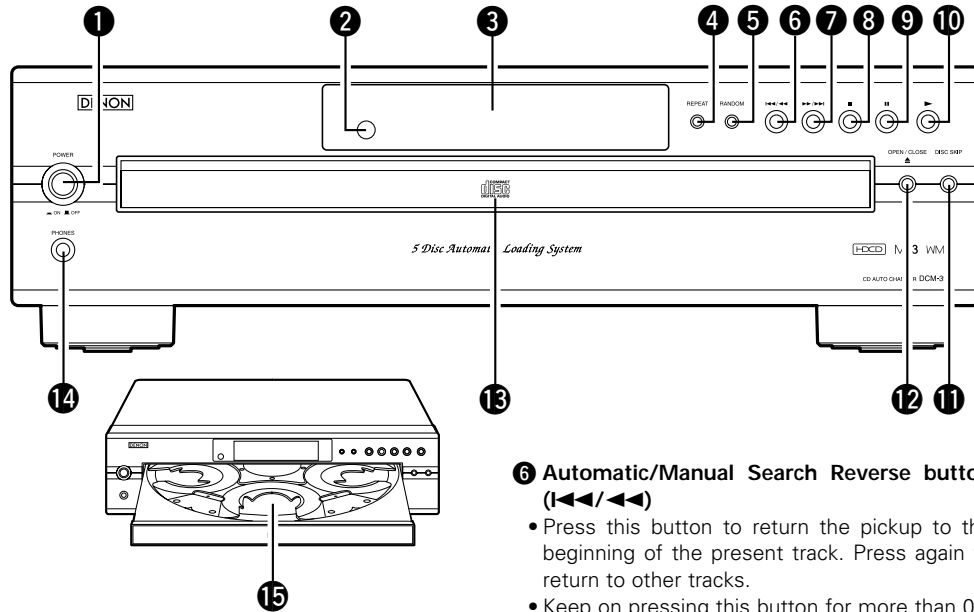

- 1 POWER switch**
 - Press once to turn the power on.
 - If a disc is loaded when the power is turned on, playback starts automatically.
- 2 Remote control sensor**

This sensor receives the infrared light transmitted from the wireless remote control unit.
- 3 Display**
- 4 REPEAT button**

Press this button for repeated playback. The "REPEAT" indicator appears on the display. Three types of repeat modes are available. (See page 10)
- 5 RANDOM button**

Press this button to begin random play.

- 6 Automatic/Manual Search Reverse button (◀◀/◀)**
 - Press this button to return the pickup to the beginning of the present track. Press again to return to other tracks.
 - Keep on pressing this button for more than 0.5 seconds during playback for fast reverse search.
- 7 Automatic/Manual Search Forward button (▶/▶▶)**
 - Press this button to move the pickup forward to the beginning of the next track. Press again to move ahead to other tracks.
 - Keep on pressing this button for more than 0.5 seconds during playback for fast forward search.
- 8 Stop button (■)**

Press this button to stop playback.
- 9 Pause button (||)**

Press this button to stop play temporarily.
- 10 Play button (▶ PLAY)**

Press this button to play a disc.

- 11 DISC SKIP button**

Each time this button is pressed, the carousel will rotate in a clockwise direction to the next tray position. This allows for loading or unloading of discs.

This button is also used to select the next disc, in the normal play continuously.
- 12 OPEN/CLOSE button (▲)**
 - Press this button when opening.
 - The drawer is opened toward the front.
 - Press the button again to close the drawer.
- 13 Loading Drawer**

Discs can be loaded and unloaded when this drawer is open. Do not force the drawer closed by hand.
- 14 PHONES jack**

For private listening, you can connect your headphones (commercially available) to this jack.
- 15 Disc Trays (1 ~ 5)**

One disc per tray can be loaded.

Getting Started

Display

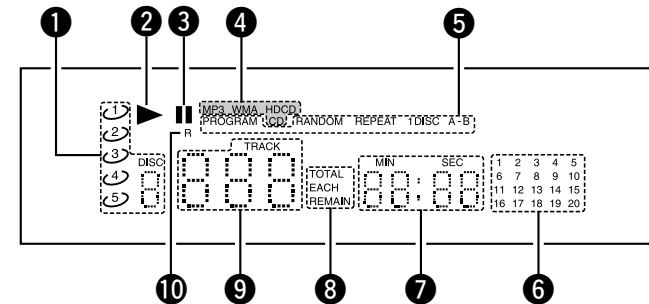

- 1 Disc indicator**
- 2 Play indicator**
- 3 Pause indicator**
- 4 Playing disc indicator**
 - HDCD indicator (DCM-390 only)
- 5 Playing mode indicator**
- 6 20-track music calendar**
- 7 Time indicator**
- 8 Time display mode indicator**
- 9 Track number indicator**
- 10 Remote control signal receive indicator**

• **HDCD**®, **HDCD**®, **High Definition Compatible Digital**® and **Microsoft**® are either registered trademarks or trademarks of Microsoft Corporation, Inc. in the United States and/or other countries. **HDCD** system manufactured under license from Microsoft Corporation, Inc. This product is covered by one or more of the following: In the USA: 5,479,168, 5,638,074, 5,640,161, 5,808,574, 5,838,274, 5,854,600, 5,864,311, 5,872,531, and in Australia: 669114. Other patents pending.

• "Windows Media®", "Windows®" are trademarks of Microsoft Corporation, Inc.

Getting Started

Rear panel

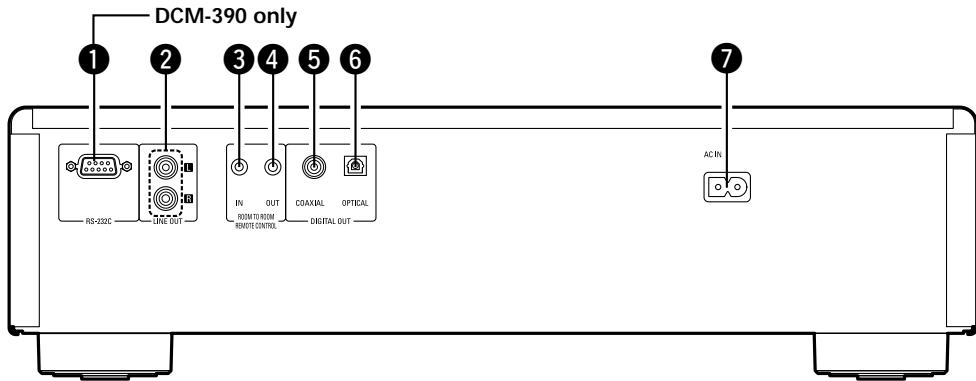

- 1 RS-232C terminal (DCM-390 only)**
This is a terminal for future system expansion.
- 2 LINE OUT terminal**
Connect these to the amplifier's input terminal.
- 3 REMOTE CONTROL jack (ROOM TO ROOM IN)**
This is the input connector for wired remote control.
Consult your DENON dealer if you wish to use this connector.
- 4 REMOTE CONTROL jack (ROOM TO ROOM OUT)**
This is the output connector for wired remote control.
Consult your DENON dealer if you wish to use this connector.

- 5 COAXIAL terminal**
This terminal outputs digital data.
Connect using a 75 Ω/ohms coaxial cable (commercially available) intended for digital audio connections.
- 6 OPTICAL terminal**
Digital data is output in optical form from this terminal.
Connect using an optical fiber cable (commercially available).
- 7 AC inlet**
Connect to an AC power supply using the included power supply cord.

Getting Started

Remote control unit

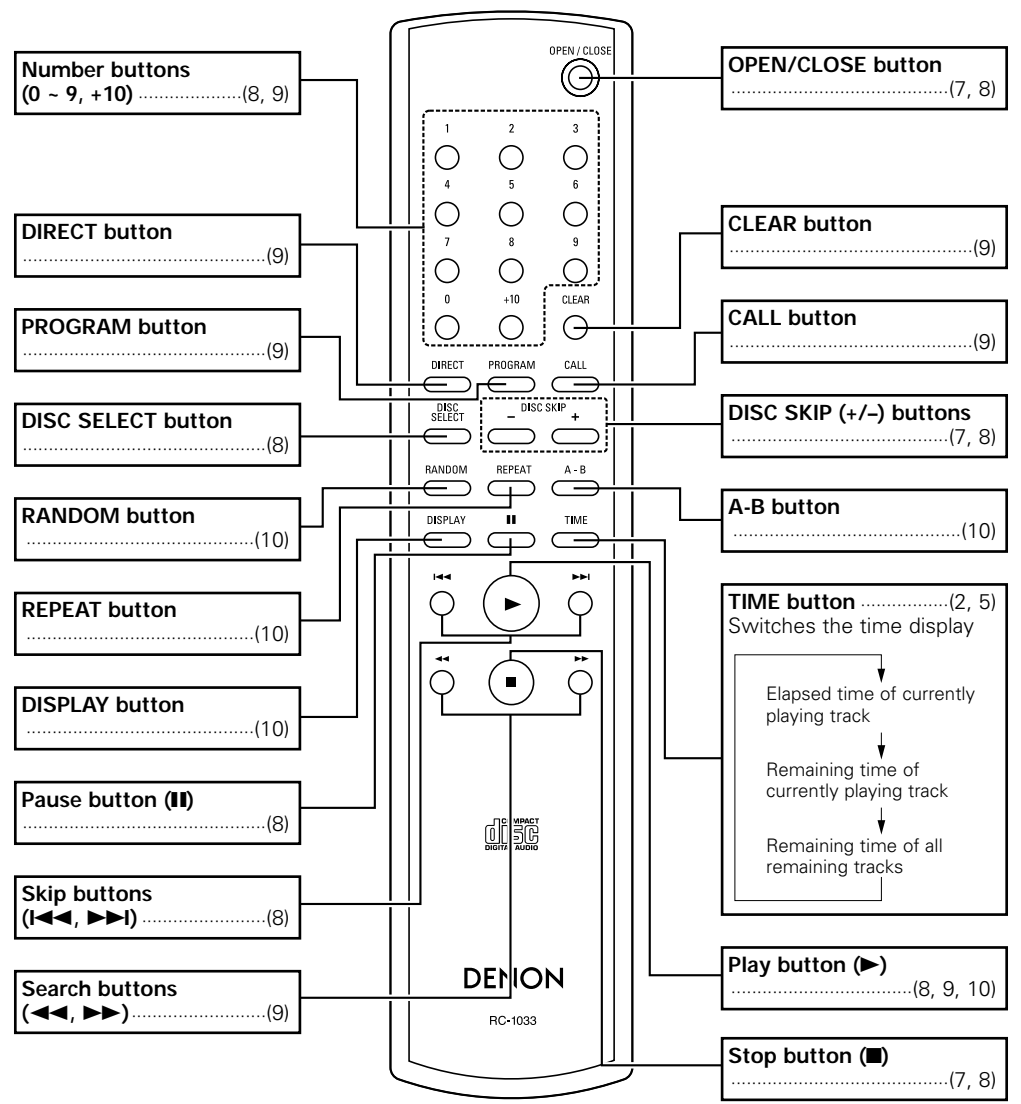

• If the automatic search forward button (▶▶▶), automatic search reverse button (I<<<) or +10 button are held in, the function of these button will be repeated.

Connections

NOTE:

- Do not plug in the power supply cord until all connections have been completed.
- When making connections, also refer to the operating instructions of the other components.
- Be sure to connect the left and right channels properly (left with left, right with right).
- Making connections with the power turned on could result in noise or damage the speakers.
- Bunching the power supply cords and connection cables together could result in humming or noise.

Cable indications

Connect using the connection cables shown below.

Audio cable	Signal direction
<p>A Analog connections (Stereo)</p> <p>Pin-plug cable</p>	<p>Audio signal</p> <p>OUT IN</p>
<p>B Digital connections (Coaxial)</p> <p>Coaxial cable (75 Ω/ohms pin-plug cable)</p>	
<p>C Digital connections (Optical)</p> <p>Optical fiber cable</p>	

Analog connections

Use the included pin-plug cable to connect the left (L) and right (R) output terminal (LINE OUT) of the CD Player to the CD, AUX or TAPE PLAY left (L) and right (R) input terminal of the amplifier.

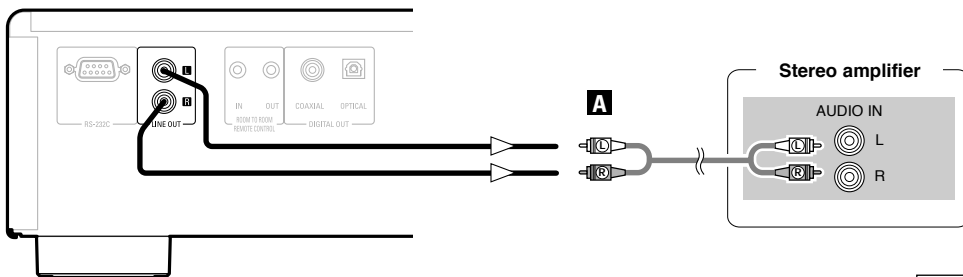

Digital connections

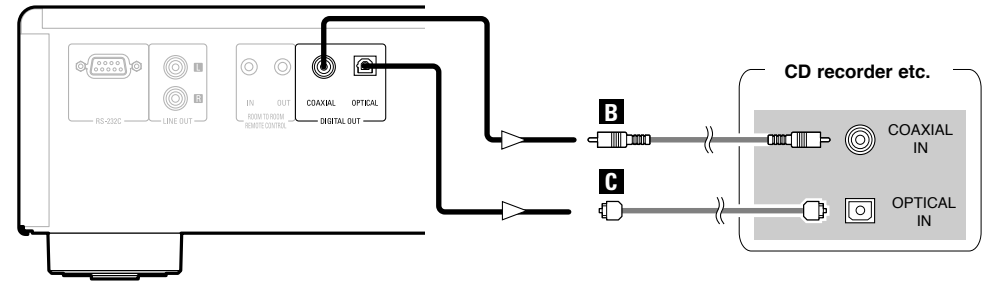

• Digital signals are output from optical terminal and coaxial terminal with parallel.

□ When connecting the **OPTICAL** digital output connector with an optical transmission cable (commercially available)

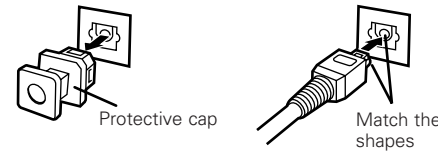

Remove the protective cap, match the shapes then insert firmly all the way in.



• Store the protective cap in a safe place so as not to lose it, and use it when not using the terminal.

Connecting the power supply cord

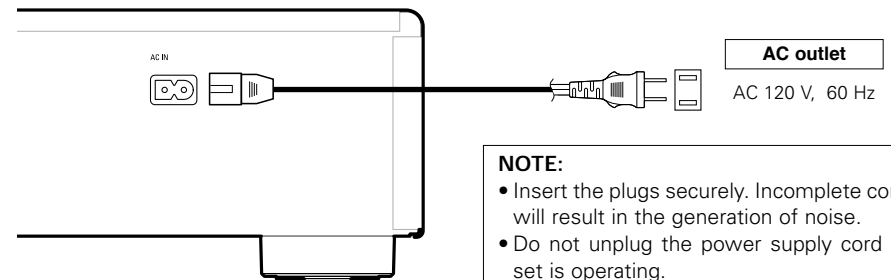

NOTE:

- Insert the plugs securely. Incomplete connections will result in the generation of noise.
- Do not unplug the power supply cord while the set is operating.

Operation

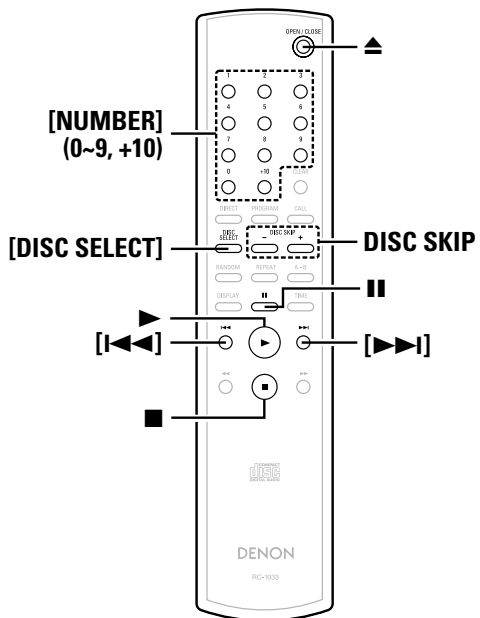
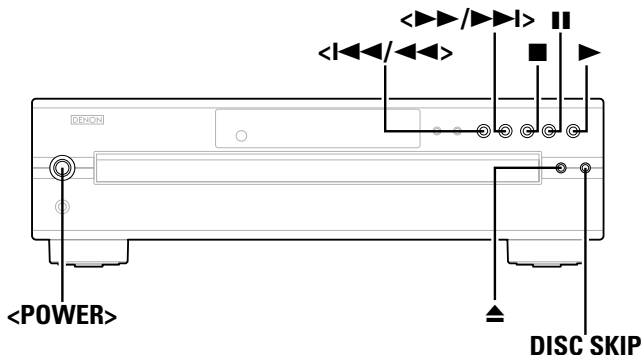

About the button names in this explanation
 < > : Buttons on the main unit
 [] : Buttons on the remote control unit
Button name only :
 Buttons on the main unit and remote control unit

Turning the power on

Press <POWER>.

- When a disc is loaded, playback starts automatically.
- If no disc is loaded "0 000 00:00" is displayed.

To turn off the power:
 Press <POWER> again.

NOTE:

- To turn off the power while a disc is playing, be sure to press ■ to stop playback before turning off the power.

Opening and closing the drawer and loading a disc

1 Press ▲.

- Make sure the drawer is completely open.

※ Hold the disc by the edges and place it on the disc tray. (Do not touch the signal surface, i.e., the glossy side.)

2 Set the disc properly in the tray according to its size.

- Set 8 cm discs in the center hole.
- Set 12 cm discs in the outer hole.

3 Press DISC SKIP.

- The carousel turns and a disc can be loaded in the another disc tray.
- When the drawer is opened during the play mode, it is possible to load and unload discs in all of the disc trays other than the one whose disc is currently playing.

4 Press ▲ again.

NOTE:

- The player will not operate properly and the disc may even be damaged if it is not set correctly.
- If your finger should get caught in the drawer when it closes, press ▲.
- Do not place any foreign objects on the disc tray, and do not place more than one disc on the tray at a time. Otherwise malfunction may occur.
- Do not push in the disc tray manually when the power is off as this may cause malfunction and damage the CD player.
- Do not touch the carousel while it is turning. Also, do not turn the carousel by hand when it is stopped. Doing so could damage it.
- Do not insert disc where indicated by arrow. This could damage the internal mechanism in the unit.

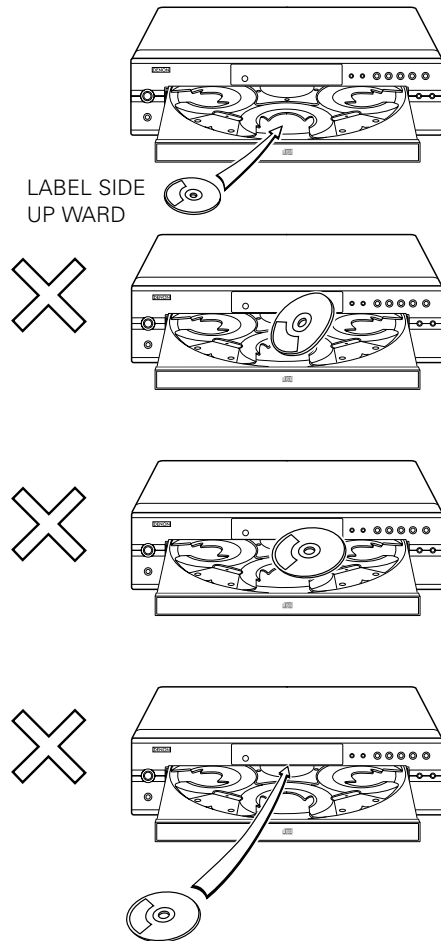

Operation

Starting playback

Press ▶.

- The drawer closes and the disc just loaded is played.
- Playback starts.

- ※ If ▲ is pressed while a disc is playing, playback continues, but the drawer opens and four discs can be replaced. The disc that can be replaced switches when **DISC SKIP** is pressed.
- ※ Playback stops automatically after the last track on the disc has been played.

To stop playback

Press ■ during playback.

- Playback stops.

Various playback functions

Playing the desired disc and desired track
[Direct play]**1** Press [DISC SELECT].**2** Use [NUMBER] (1 to 5) to select the disc.**3** Use [NUMBER] (0 ~ 9, +10) to select the track.

Example: To play the 4th track on the 3rd disc:
Press [DISC SELECT] [3] [4].

Example: To play the 12th track on the 5th disc:
Press [DISC SELECT] [5] [+10] [2].

4 Playback begins from the number of the disc and track selected.

To move to the next disc during playback

1 Press DISC SKIP.

- ※ The carousel in the drawer turns and the disc on the next tray is played.

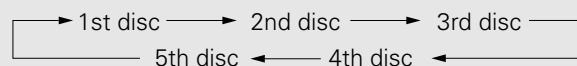

- When [DISC SKIP-] on the remote control unit is pressed, the carousel turns in the opposite direction and the previous disc is played.

Operation

To pause playback

Use this function to stop playback temporarily, and later resume playback from that point.

Press || during playback.

- Playback pauses.

 To resume playback:

Press ▶.

Automatic search

 Moving ahead to the beginning of the next track (file):**Press [▶▶▶] or <▶▶▶/▶▶▶> during playback.**

- The pickup will advance to the beginning of the next track and playback will continue. Pressing the button several times will forward the pickup the corresponding number tracks.

- ※ Normal playback resumes when you release your finger from the button.

 Moving back to the beginning of the current track (file):**Press [◀◀◀] or <◀◀◀/◀◀◀> during playback.**

- The pickup will advance to the beginning of the next track and playback will continue. Pressing the button several times will forward the pickup the corresponding number tracks.

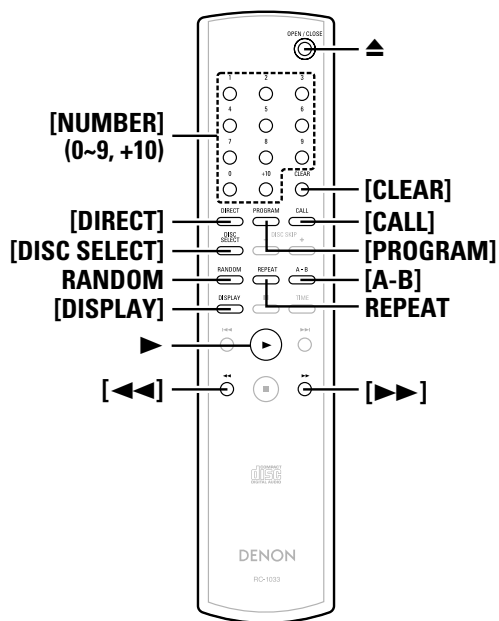
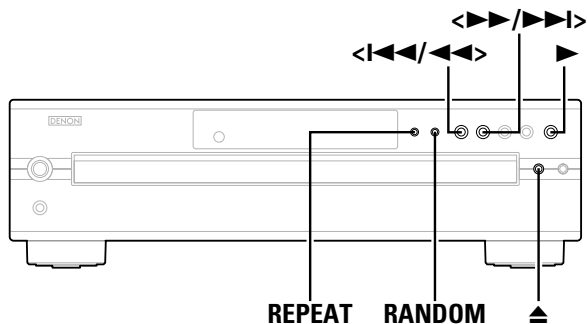

About the button names in this explanation
 < > : Buttons on the main unit
 [] : Buttons on the remote control unit
Button name only :
 Buttons on the main unit and remote control unit

Manual search

Use this function to skip forward or backward while listening to the sound.

Searching forward:

Press [▶▶] or press and hold <▶▶/▶▶▶ during playback.

- "]]" is displayed if the end of the last track is reached during manual searching. If this happens, use [◀◀] or <◀◀/◀◀◀ to turn the display off.

Searching backward:

Press [◀◀] or press and hold <◀◀/◀◀◀ during playback.

- "[[" is displayed if the beginning of the first track is reached during manual searching. If this happens, use [▶▶] or <▶▶/▶▶▶ to turn the display off.

NOTE:
 • The sound may be interrupted momentarily when resuming normal playback from the manual search mode. This is not a malfunction.

Programmed play

You can play certain tracks on the loaded discs in any order. Up to 32 tracks can be set in a program.

1 Press [PROGRAM].
 • The "PROGRAM" indicator lights.

2 Press [DISC SELECT], [NUMBER] to select the disc to be programmed.

Example: To program the 3rd track on the 2nd disc and the 12 track on the 5th disc:
 Press [PROGRAM] [DISC SELECT] [2] [3], [DISC SELECT] [5] [+10] [2].

3 Press ▶.
 • The tracks are played in the programmed order.

Checking the programmed tracks:
 Press [CALL].
 The tracks are displayed in the programmed order each time the button is pressed.

Clearing tracks from the program:
 Press [CLEAR] while the track you want to clear is displayed during the "Checking the programmed tracks" operation above.

Stopping programmed playback:
 Press [DIRECT] or press ▲ to open the disc tray.

- Tracks on a disc not loaded can also be programmed, but if you try to play that disc, the microprocessor detects that it is not loaded and the following disc is played automatically.
- When programming, do not program a track number which is not recorded on the disc. If such a number is programmed by mistake, the player ignore the program.
- For programmed playback, the remaining time for the program is only displayed when the programmed tracks are all on the same disc.
 " - - : - - " is displayed when tracks on more than one disc are programmed.
- In the case that the total playing time of programmed tracks becomes more than 99:59, " - - : - - " is displayed.

Operation

Random play

Use this function to play all the tracks on the all discs or a disc once in random order.

 Full Random Play:

- 1 Press RANDOM.**
- The "RANDOM" indicator lights.

- 2 Press ►.**
- A track is selected automatically and playback starts.

- ※ During programmed playback:
The programmed tracks are played in random order.
- ※ During repeat playback:
The tracks are played once in random order, then played again in a different order, and this is repeated.

 Stopping random playback:

Press **RANDOM** or **[DIRECT]**.

NOTE:

- During random play, the player may display the number of disc which is not loaded in the tray. In such a case, the player will read the disc information, then reset automatically to correct. This is not a malfunction.

 Disc Sequential Random Play:

- 1 Press RANDOM and specify the disc numbers (1 to 5) with the [DISC SELECT] and the [NUMBER].**

- 2 Press ►.**
- A track is selected automatically and playback starts.

Repeat play**1 Press REPEAT once.****2 Press ►.**

- ※ During regular playback:
All the tracks are played repeatedly.
- ※ During programmed playback:
The tracks are played repeatedly in the programmed order.
- ※ In the random play mode:
The tracks are played once each in random order, then played again in a different order.

 Stopping all-track repeat playback:

Press **REPEAT** twice in a row or press **▲** to open the disc tray.



- In the programmed play or random play mode during all-track repeat playback, normal playback resumes when **REPEAT** is pressed once.

 A-B repeat play:

- 1 During playback, press [A-B] at the point at which you want to start repeating (point A).**

- The "A-B" indicator blinks.

- 2 During playback, press [A-B] at the point at which you want to stop repeating (point B).**

- The "A-B" indicator lights and the A-B section is played repeatedly.

 Stopping A-B repeat playback:

Press **[A-B]** again.



- The pickup will now return to the starting point and repeat playback of the selected interval.
- A-B repeat playback is not possible during programmed playback or random playback.

Other functions **Switching the display brightness:**

The brightness can be switched in three steps or turned off. Press **[DISPLAY]**.

Troubleshooting

If a problem should arise, first check the following.

1. Are the connections correct?

2. Have you operated the player according to the Operating Instructions?

If this unit is not operating properly, check the items listed in the table below. Should the problem persist, there may be a malfunction. Disconnect the power immediately and contact your store of purchase.

Symptom	Cause	Measures	Page
Disc tray does not open.	<ul style="list-style-type: none"> The power is not on. 	<ul style="list-style-type: none"> Turn on the power. 	7
"0 000 00:00" is displayed even though a disc is loaded.	<ul style="list-style-type: none"> The disc is not properly loaded. The loaded disc is not a CD. 	<ul style="list-style-type: none"> Reload the disc. Load a CD. 	2, 3 2
Disc is not played when ► button is pressed.	<ul style="list-style-type: none"> The disc is dirty or scratched. 	<ul style="list-style-type: none"> Wipe the dirt off the disc or replace the disc. 	3
No sound is produced or sound is distorted.	<ul style="list-style-type: none"> The output cables are not properly connected to the amplifier. The amplifier's function setting or adjustments are not right. 	<ul style="list-style-type: none"> Check the connections. Check the amplifier's function and controls and adjust as necessary. 	6 –
No digital signals are output.	<ul style="list-style-type: none"> The connection cables are not properly connected. 	<ul style="list-style-type: none"> Check the connections. 	6
Specific section of the disc cannot be played properly.	<ul style="list-style-type: none"> The disc is dirty or scratched. 	<ul style="list-style-type: none"> Wipe the dirt off the disc or replace the disc. 	3
Programmed playback is not possible.	<ul style="list-style-type: none"> The tracks have not been programmed properly. 	<ul style="list-style-type: none"> Program properly. 	9
A CD-R or CD-RW disc cannot be played.	<ul style="list-style-type: none"> The disc has not been finalized. The recording conditions are bad or the quality of the disc itself is poor. 	<ul style="list-style-type: none"> Finalize the disc then play it. Use a properly recorded disc. 	2 2
Set does not operate properly when remote control unit is operated.	<ul style="list-style-type: none"> The batteries are spent. The remote control unit is too far from the set. 	<ul style="list-style-type: none"> Replace the batteries with new ones. Move the remote control unit closer to the set. 	3 3
"– : –" is displayed when playing files recorded in MP3 or WMA format.	<ul style="list-style-type: none"> You have selected a copyright-protected WMA file or a file that cannot be played normally. 	<ul style="list-style-type: none"> Use the ◀◀/◀◀ or ▶▶/▶▶ button on the main unit (the ◀◀ or ▶▶ button on the remote control unit) to select a different file. 	2

Specifications

□ Audio performance

	DCM-390	DCM-290/27
• Analog output		
Channels:	2 channels	
Playable frequency range:	2 Hz ~ 20 kHz	
S/N:	112 dB	108 dB
Dynamic range:	100 dB	98 dB
Harmonic distortion:	0.0027 % (1 kHz)	0.003 %
Separation:	98 dB	98 dB
Wow & flutter:	Less than the measuring	
Output level:	Fix 2.0 V (10 k Ω /kohms)	
Signal type:	16-bit linear PCM	
Sampling frequency:	44.1 kHz	
Usable discs:	Audio compact discs are used 12 cm (5 inch) and 8 cm (3 inch)	
• Digital output		
Coaxial:	0.5 Vp-p (75 Ω /ohms)	
OPTICAL:	- 15 ~ - 21 dBm	
Light emission wavelength:	660 nm	
• Phones output	0.04mW	

□ General

Power supply:	AC 120 V, 60 Hz
Power consumption:	15 W
Maximum external dimensions:	434 (W) x 120 (H) x 400 (D) mm (17-3/32" x 4-3/4" x 15-3/4") (including protruding parts)
Mass:	6.3 kg (13.1 lbs.)

□ Remote control unit (RC-1033)

Remote control type:	Infrared pulse
Batteries:	R03/AAA Type (two batteries)
External dimensions:	49 (W) x 220 (H) x 21 (D) mm (1-15/16" x 8-11/16" x 7/8")
Mass:	106 g (0.23 lbs.) (included batteries)

* For purposes of improvement, specifications and design are subject to change without notice.

DENON

TOKYO, JAPAN
www.denon.com

Denon Brand Company, D&M Holdings Inc.
Printed in China 00D 511 4437 001