

Panasonic®

Palmcorder® PalmSight™

Camcorder

Operating Instructions

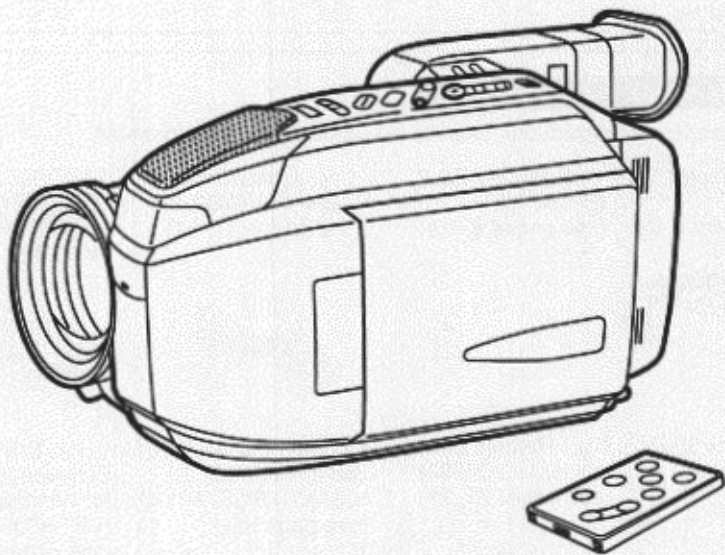

VHS

PV-L958

Please read these instructions carefully before attempting to operate this product. Please save this manual.

Spanish Quick Use Guide is included.

Guía para rápida consulta en español está incluida.

VQW0689(A)

Things You Should Know

Thank you for choosing Panasonic!

You have purchased one of the most sophisticated and reliable products on the market today. Used properly, it will bring you years of enjoyment. Please take time to fill in the information below. The serial number is on the tag located on the underside of your Camcorder. Be sure to **retain this manual** as your convenient Camcorder information source.

Date of Purchase _____

Dealer Purchased From _____

Dealer Address _____

Dealer Phone No. _____

Model No. _____

Serial No. _____

Unpack your Camcorder

These accessories are provided in order to set up or use your Camcorder.

1 pc. AC Adaptor
(PV-A17)
with DC Power Cable
(see page 11)

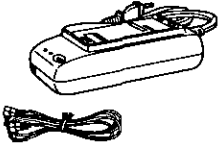

1 pc. Battery Pack
(PV-BP18)
(see pages 9, 10)



1 pc. Audio/Video
Cable (VJAW0039)
(see pages 31, 51)



1 pc. VHS PlayPak
(PV-P1/VYMW0009)
and one "AA" battery
(see page 32)

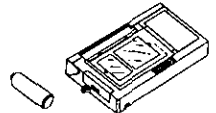

1 pc. Shoulder Strap
(VYCW0149)
(see page 21)



1 pc. Remote Control
Holder (VGQ6893)
(see pages 21, 28)



1 pc. PC Connection
cable (RS232C-3P)
(LSJA0185/LSJA0190)
(see page 58)

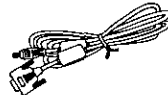

1 pcs. Driver
Software Floppy Disk
for Windows 95
(VFTW0006)
(see page 59)

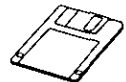

1 pc. CR2025 Clock
Battery (VSBW0004)
(installed in
Camcorder)
(see page 17)



1 pc. 8-Function Remote
(VSQW0038) with one
CR2025 Battery



Remote has been loaded with
battery. (see page 28)

1 pc. Wiping Cloth
(VFCW0001)



Use this wiping cloth to clean
the display screen of finger
prints and other smudges.

Things You Should Know





Safety Precautions

WARNING: TO PREVENT FIRE OR SHOCK HAZARD, DO NOT EXPOSE THIS EQUIPMENT TO RAIN OR MOISTURE.

Your Compact VHS Camcorder is designed to record and play back in Standard Play (SP) and Super Long Play (SLP) modes. You can also play a Compact VHS Camcorder recording on your VHS VCR using the VHS PlayPak supplied.

This Camcorder is equipped with the HQ System to provide excellent video pictures, and is compatible with standard VHS equipment.

It is recommended that only cassette tapes that have been tested and inspected for use in VCR machines with the **VHS** and/or **VHS** mark be used.

	CAUTION RISK OF ELECTRIC SHOCK DO NOT OPEN			This symbol warns the user that uninsulated voltage within the unit may have sufficient magnitude to cause electric shock. Therefore, it is dangerous to make any kind of contact with any inside part of this unit.
CAUTION: TO REDUCE THE RISK OF ELECTRIC SHOCK, DO NOT REMOVE COVER (OR BACK) NO USER-SERVICEABLE PARTS INSIDE REFER SERVICING TO QUALIFIED SERVICE PERSONNEL				This symbol alerts the user that important literature concerning the operation and maintenance of this unit has been included. Therefore, it should be read carefully in order to avoid any problems.

The above markings are located on the appliance bottom cover.

FCC Warning: To assure continued FCC compliance, the user must use only provided shielded interfacing cable with ferrite cores when connecting to computer. Also, any unauthorized changes or modifications to this equipment would void the users authority to operate.

This device complies with Part 15 of the FCC Rules. Operation is subject to the following two conditions: (1) This device may not cause harmful interference, and (2) this device must accept any interference received, including interference that may cause undesired operation.

Note: This equipment has been tested and found to comply with the limits for a Class B digital device and a RF Lighting device, pursuant to part 15 and Part 18 of the FCC Rules.

These limits are designed to provide reasonable protection against harmful interference in a residential installation. This equipment generates, uses and can radiate radio frequency energy and, if not installed and used in accordance with the instructions, may cause harmful interference to radio communications. However, there is no guarantee that interference will not occur in a particular installation. If this equipment does cause harmful interference to radio or television reception, which can be determined by turning the equipment off and on, the user is encouraged to try to correct the interference by one or more of the following measures:

- Reorient or relocate the receiving antenna.
- Increase the separation between the equipment and receiver.
- Connect the equipment into an outlet on a circuit different from that to which the receiver is connected.
- Consult the dealer or an experienced radio/TV technician for help.

Important Safeguards

1. **Read Instructions** — All the safety and operating instructions should be read before the unit is operated.
2. **Retain Instructions** — The safety and operating instructions should be retained for future reference.
3. **Heed Warnings** — All warnings on the unit and in the operating instructions should be adhered to.
4. **Follow Instructions** — All operating and maintenance instructions should be followed.
5. **Cleaning** — Unplug this video unit from the wall outlet before cleaning. Do not use liquid or aerosol cleaners. Use a dry cloth for cleaning.
6. **Attachments** — Do not use attachments not recommended by the video product manufacturer as they may be hazardous.
7. **Water and Moisture** — Do not use this video unit near water — for example near a bath tub, wash bowl, kitchen sink, or laundry tub, in a wet basement, or near a swimming pool, and the like.
8. **Accessories** — Do not place this video unit on an unstable cart, stand, tripod, bracket, or table. The video unit may fall, causing serious injury to a child or adult, and serious damage to the unit. Use only with a cart, stand, tripod, bracket, or table recommended by the manufacturer, or sold with the video unit. Any mounting of the unit should follow the manufacturer's instructions and should use a mounting accessory recommended by the manufacturer. An appliance and cart combination should be moved with care. Quick stops, excessive force, and uneven surfaces may cause the appliance and cart combination to overturn.
9. **Ventilation** — Slots and openings in the cabinet are provided for ventilation and to ensure reliable operation of the video unit and to protect it from overheating. These openings must not be blocked or covered. Never place the video unit on a bed, sofa, rug, or other similar surface, or near or over a radiator or heat register. This video unit should not be placed in a built-in installation such as a bookcase or rack unless proper ventilation is provided or the manufacturer's instructions have been adhered to.



10. **Power Sources** — This video unit should be operated only from the type of power source indicated on the marking label. If you are not sure of the type of power supply to your home, consult your appliance dealer or local power company. For video units intended to be operated from battery power, or other sources, refer to the operating instructions.

11. **Grounding or Polarization** — This video unit may be equipped with either a polarized 2-wire AC (Alternating Current) line plug (a plug having one blade wider than the other) or 3-wire grounding type plug, a plug having a third (grounding) pin. The 2-wire polarized plug will fit into the power outlet only one way. This is a safety feature. If you are unable to insert the plug fully into the outlet, try reversing the plug. If the plug still fails to fit, contact your electrician to replace your obsolete outlet. Do not defeat the safety purpose of the polarized plug. The 3-wire grounding type plug will fit into a grounding type power outlet. This is a safety feature. If you are unable to insert the plug into the outlet, contact your electrician to replace your obsolete outlet. Do not defeat the safety purpose of the grounding type plug.
12. **Power-Cord Protection** — Power-supply cords should be routed so that they are not likely to be walked on or pinched by items placed upon or against them. Paying particular attention to cords of plugs, convenience receptacles, and the point where they exit from the unit.
13. **Outdoor Antenna Grounding** — If an outside antenna or cable system is connected to the video unit, be sure the antenna or cable system is grounded so as to provide some protection against voltage surges and built-up static charges. Part 1 of the Canadian Electrical Code, in USA Section 810 of the National Electrical Code, provides information with respect to proper grounding of the mast and supporting structure, grounding of the lead-in wire to an antenna discharge unit, size of grounding conductors, location of antenna discharge unit, connection to grounding electrodes, and requirements for the grounding electrode.

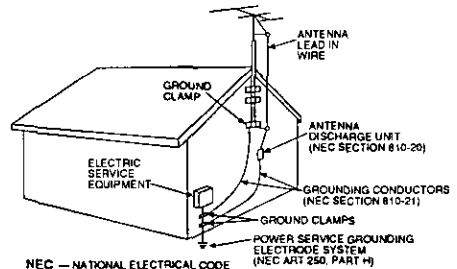

14. **Lightning** — For added protection of this video unit receiver during a lightning storm, or when it is left unattended and unused for long periods of time, unplug it from the wall outlet and disconnect the antenna or cable system. This will prevent damage to the video unit due to lightning and power-line surges.

Important Safeguards

15. **Power Lines** — An outside antenna system should not be located in the vicinity of overhead power lines or other electric light or power circuits, or where it can fall into such power lines or circuits. When installing an outside antenna system, extreme care should be taken to keep from touching such power lines or circuits as contact with them might be fatal.
16. **Overloading** — Do not overload wall outlets and extension cords as this can result in a risk of fire or electric shock.
17. **Objects and Liquids** — Never push objects of any kind into this video unit through openings as they may touch dangerous voltage points or short out parts that could result in a fire or electric shock. Never spill liquid of any kind onto the video unit.
18. **Service** — Do not attempt to service this video unit yourself as opening or removing covers may expose you to dangerous voltage or other hazards. Refer all servicing to qualified service personnel.
19. **Damage Requiring Service** — Unplug this video unit from the wall outlet and refer servicing to qualified service personnel under the following conditions:
 - a. When the power-supply cord or plug is damaged.
 - b. If any liquid has been spilled onto, or objects have fallen into the video unit.
 - c. If the video unit has been exposed to rain or water.
 - d. If the video unit does not operate normally by following the operating instructions. Adjust only those controls that are covered by the operating instructions, as an improper adjustment of other controls may result in damage and will often require extensive work by a qualified technician to restore the video unit to its normal operation.
 - e. If the video unit has been dropped or the cabinet has been damaged.
 - f. When the video unit exhibits a distinct change in performance — this indicates a need for service.
20. **Replacement Parts** — When replacement parts are required, be sure the service technician has used replacement parts specified by the manufacturer or have the same characteristics as the original part. Unauthorized substitutions may result in fire, electric shock or other hazards.
21. **Safety Check**— Upon completion of any service or repairs to this video unit, ask the service technician to perform safety checks to determine that the video unit is in safe operating order.

Precautions

USE & LOCATION

- **TO AVOID SHOCK HAZARD ...** Your Camcorder and power supply should not be exposed to rain or moisture. Do not connect the power supply or operate your Camcorder if it gets wet. Your Camcorder has been designed for outdoor use, however it is not designed to sustain direct exposure to water, rain, sleet, snow, sand, dust, or a direct splashing from a pool or even a cup of coffee. This action could permanently damage the internal parts of your Camcorder. Do not attempt to disassemble this unit. There are no user serviceable parts inside. Unplug your Camcorder from the power supply before cleaning.
- **DO NOT AIM YOUR CAMCORDER AT THE SUN OR OTHER BRIGHT OBJECTS.**
- **DO NOT LEAVE THE CAMCORDER WITH THE EVF AIMED DIRECTLY AT THE SUN AS THIS MAY CAUSE DAMAGE TO THE INTERNAL PARTS OF THE EVF.**
- **DO NOT EXPOSE YOUR CAMCORDER TO EXTENDED HIGH TEMPERATURE ...** Such as, in direct sunlight, inside a closed car, next to a heater, etc... This action could permanently damage the internal parts of your Camcorder.
- **AVOID SUDDEN CHANGES IN TEMPERATURE ...** If the unit is suddenly moved from a cold place to a warm place, moisture may form on the tape and inside the unit.
- **DO NOT LEAVE YOUR CAMCORDER OR THE POWER SUPPLY TURNED ON WHEN NOT IN USE.**
- **STORAGE OF YOUR CAMCORDER ...** Store and handle your Camcorder in a manner that will not subject it to unnecessary movement (avoid shaking and striking). Your Camcorder contains a sensitive pick-up device which could be damaged by improper handling or storage.

CARE

- **TO CLEAN YOUR CAMCORDER ...** Do not use strong or abrasive detergents when cleaning your Camcorder body.
- **TO PROTECT THE LENS ...** Do not touch the surface of the lens with your hand. Use a commercial camcorder lens solution and lens paper when cleaning the lens. Improper cleaning can scratch the lens coating.
- **TO PROTECT THE FINISH OF YOUR CAMCORDER ...** Before handling your Camcorder, make sure your hands and face are free from any chemical products, such as suntan lotion, as it may damage the finish.

Table of Contents

Getting Started

Things You Should Know	2
Important Safeguards	4
Precautions	5
Self Demo Mode	7
Quick Operation Guide	8
Supplying Power	9
Cassette Information	12
MENU Mode	13
Setting the Clock	14
Electronic Viewfinder/LCD Monitor Indications	18
Attaching the Shoulder Strap and Remote Control Holder	21
Built-in Auto Light	22

Basic Operation

Camera Recording	23
8-Function Remote Control	28
Playing Back your Recordings	29

Special Features

Four-Speed Power Zoom	33
Backlight	33
Focus	34
High Speed Shutter	35
Fade	36
Color Digital Filter	38
Digital Zoom	39
Digital Electronic Image Stabilization System	40
Still / Strobe / Wide	41
Digital Wipe	42
Security Mode	43
Audio Sensitivity	44
Time Lapse	45
Tally Lamp	46
Intelligent Titler	47
Message Mode	50
Copying your Tapes (dubbing)	51
Using the Digital Still Camera	52
PC Connection	58

For Your Information

Palmcorder Accessory System	61
Palmcorder Accessory Order Form	62
Notes Regarding Operations	63
Specifications	64
Before Requesting Service	65
Request for Service Notice	66
Index of Controls	67
Index	72
Warranty	73
Spanish Quick Use Guide/Guía Para Uso Rápido	75

Self Demo Mode

If the screen at right appears in the EVF/LCD Monitor, the Self Demo mode is on. To turn it off, please follow the steps below.

EVF Screen

Panasonic
IT'S VHS!
SO ITS TAPES PLAY
IN YOUR VCR
23x HI-DEFINITION LENS
300x 50x DIGITAL ZOOM
DIGITAL STABILIZATION
DEDICATED 5-HEAD
DIGITAL PHOTOSHOT

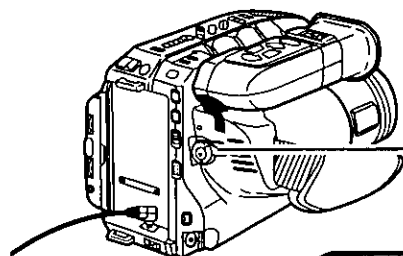

1 Set the POWER switch to CAMERA.

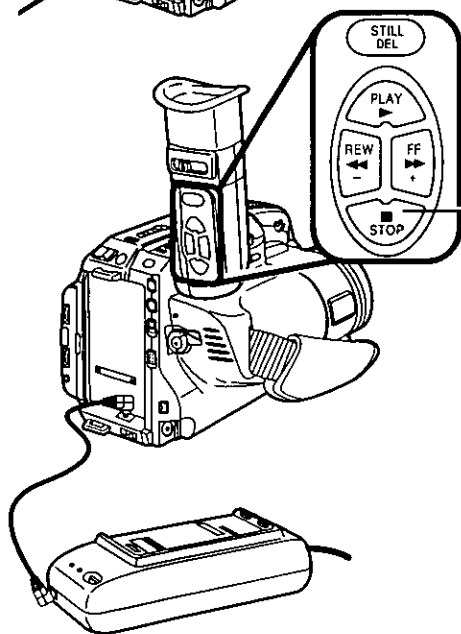

2 Hold down the STOP button for more than 5 seconds.

Note:

- The Self Demo mode will automatically turn itself off if a battery is attached (see page 9) and a cassette tape is inserted (see page 12).
- Inserting a tape alone (or attaching a partially charged battery) will only temporarily turn the Self Demo mode off.
- The Self Demo mode will temporarily stop for 30 seconds when a function key other than Power, Tape Speed Selector, Light, Message, and Digital Select is pressed.

To turn the Self Demo mode on, follow the steps below.

- With the DISPLAY button held down, slide the POWER switch to CAMERA and wait for the Self Demo screen to appear in the EVF/LCD Monitor.

Quick Operation Guide

Camera Recording

Charge the Battery Pack fully before operation (see page 9).

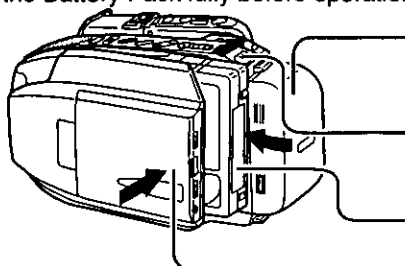

- 1** Attach a fully charged Battery (see page 9).
- 2** Slide the TAPE EJECT switch to open door.
- 3** Insert cassette (see page 12).
- 4** Press here to close door.

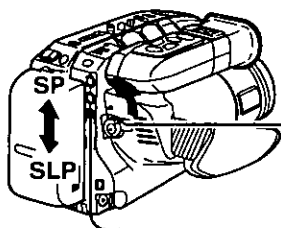

- 5** Set POWER switch to CAMERA. Built-In Lens Cover opens and POWER Lamp lights.
- 6** Slide TAPE SPEED Selector to SP or SLP (see page 12).

POWER Lamp

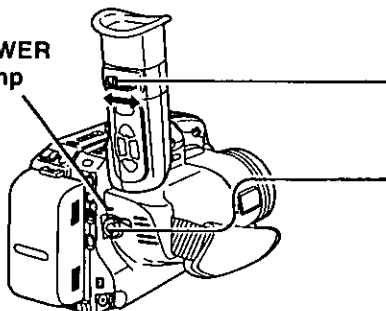

- 7** While looking into the Viewfinder, adjust the Vision Adjustment Control to your eyesight.
- 8** Press RECORD/PAUSE to start recording. Press RECORD/PAUSE again to pause recording (see page 23).

To Watch Playback in the EVF (Electronic Viewfinder)

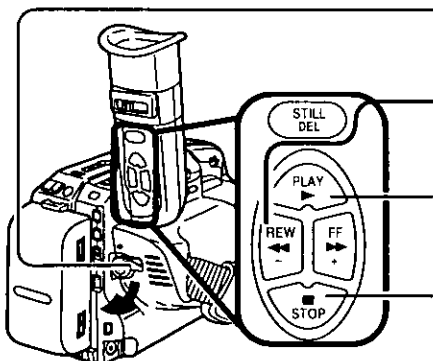

- 1** Set the POWER switch to VCR.
- 2** Press the REWIND/SEARCH to rewind tape.
- 3** Press PLAY to start playback.
- 4** Press STOP to stop playback.

Charge the Battery Pack

Charge the Battery Pack fully before operation.

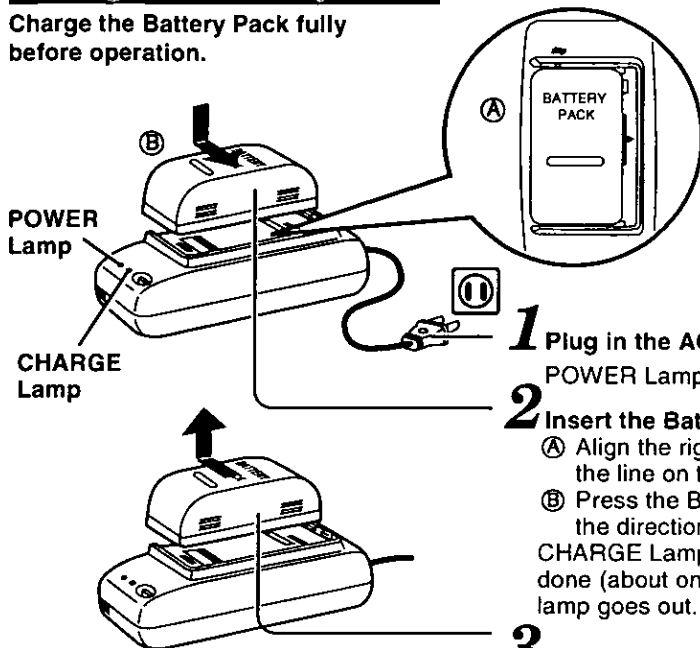

1 Plug in the AC Adaptor.
POWER Lamp lights.

2 Insert the Battery
Ⓐ Align the right side of the Battery with the line on the AC Adaptor.
Ⓑ Press the Battery down and slide it in the direction of the arrow.
CHARGE Lamp lights. When charging is done (about one and a half hours) the lamp goes out.

3 Remove the Battery
Slide the Battery out and lift up.

Note:

After recharging the Battery Pack about 5 times, use the BATTERY REFRESH feature as explained on page 10.

- The useful operation time of the Battery will gradually decrease after repeated use and recharging. The Battery is no longer serviceable if the operation time is very short, even after a sufficient charge.

Use the Battery Pack

With a fully charged Battery Pack, you will have a maximum of about 1.8 hours of continuous use (LCD monitor is off) or about 1 hour of continuous use (LCD monitor is on). (The actual operating time may vary due to operation conditions. If the Built-in Light is used, battery operating time decreases.)

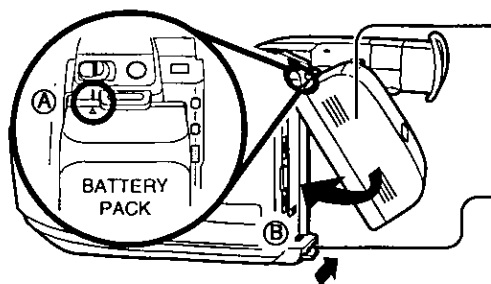

1 Attach the Battery
Ⓐ Align the Battery with the top of the mounting surface.
Ⓑ Press it into place until it locks with a click.

2 Remove the Battery
While sliding the BATTERY RELEASE button, remove the Battery.

Supplying Power

Battery Refresh Feature

This feature completely discharges the Battery before recharging begins. To maintain your Battery's operating capacity, use the refresh feature after about every five charges.

CHARGE Lamp



1 Plug in the AC Adaptor.

- The POWER Lamp remains lit as long as the AC Adaptor is plugged in.

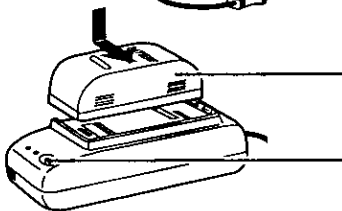

2 Place the Battery into the AC Adaptor.

3 Press the BATTERY REFRESH button.

The CHARGE Lamp flashes until discharge is complete and then stays lit until the Battery is fully charged.

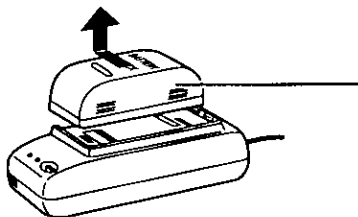

4 Remove the Battery.

- Should you accidentally press the BATTERY REFRESH button, remove the Battery and then re-insert it to begin charging.
- It takes about 7 and a half hours when both Battery Refresh and recharging are performed.

Battery Care

Caution:

- Charge only with specified charger.
- Battery can be charged within a temperature range of 50° F (10° C) and 95° F (35° C).
- Battery may be warm after charging or just after use. This is normal.
- Do not use an insufficiently charged or worn-out Battery.

Safety precautions:

- Do not get the Battery near, or dispose of in fire.
- Do not directly connect (short circuit) the positive (+) and negative (-) terminals.
- Never attempt to disassemble or reassemble the Battery.

To avoid damage to the Battery:

- Do not drop or jar Battery.
- Use Battery with specified units only.
- If Battery is used in extremely high temperatures, a safety device will automatically prevent operation.

To prolong battery life:

- While not in use, remove Battery from the Camcorder and AC Adaptor and store in a cool, dark, dry place.
- Keep Battery terminals clean.

U.S.A. CONSUMERS:

ATTENTION:

The product you have purchased is powered by a nickel cadmium battery which is recyclable. At the end of its useful life, under various state and local laws, it is illegal to dispose of this battery into your municipal waste stream. Please call 1-800-8-BATTERY for information on how to recycle this battery.



AC Adaptor

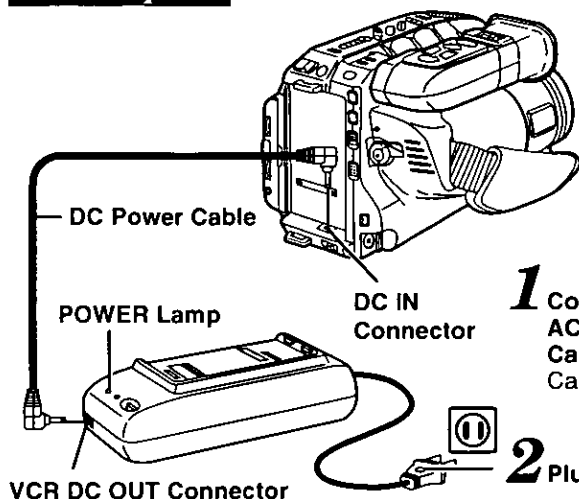

1 Connect VCR DC OUT on the AC Adaptor to DC IN on the Camcorder with the DC Power Cable (supplied).

2 Plug in the AC Adaptor.

- The POWER Lamp will light.

Notes:

- AC Adaptor cannot be used to power the Camcorder while charging the Battery.
- While not in use, unplug the AC Adaptor from the AC outlet. (When plugged into an AC outlet, the AC Adaptor consumes 1.2W of electric power when not in use.)

Car Battery Cord (Optional)

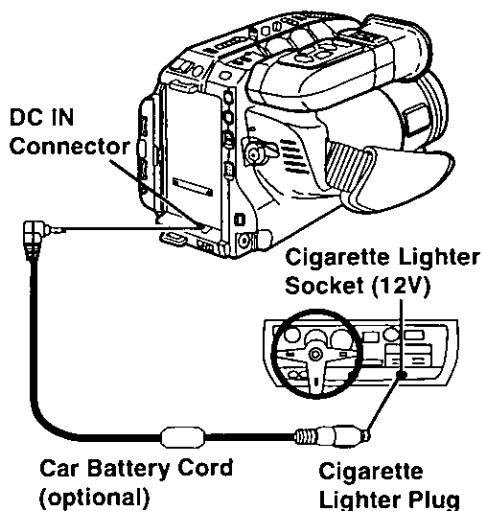

1 Connect a PV-C16 Car Battery Cord (optional) to DC IN on the Camcorder.

2 First, start your car engine, and then insert the Car Battery Cord plug into your cigarette lighter socket.

- A fuse is located in the lighter plug end of the cord.
Should fuse replacement be necessary use the exact current rating (in amps).

Notes:

- This cord can only be used in vehicles equipped with DC 12V (negative ground) batteries. Use only the specified car battery cord. If you are not sure, check with your local car/truck dealer.
- To avoid blowing the fuse, be sure to start your car engine before inserting the cigarette lighter plug of the Car Battery Cord into the lighter socket.
- Because the car is running while your Camcorder is in operation, make sure you're in a well ventilated area.
- Disconnect the cigarette lighter plug when your Camcorder is not being used.

Cassette Information

Cassette Insertion/Removal

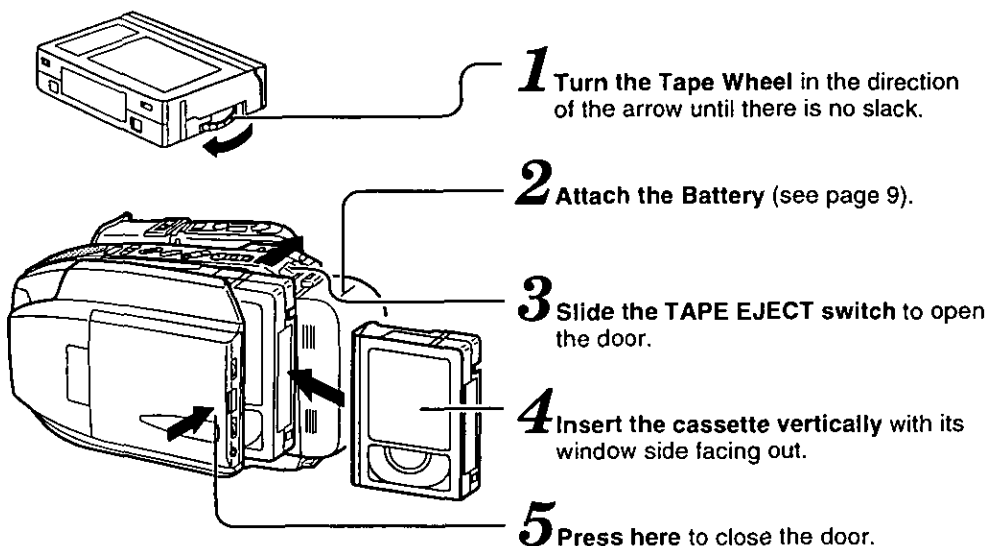

• To remove the cassette, slide the TAPE EJECT switch.

Record/Playback Time

Use tapes with the **VHS C** mark in this unit.

Tape Speed Selector Position	Cassette type		
	T-20	T-30	T-40
SP (Standard Play)	20 minutes	30 minutes	40 minutes
SLP (Super Long Play)	1 hour	1 hour 30 minutes	2 hours

TAPE SPEED Selector

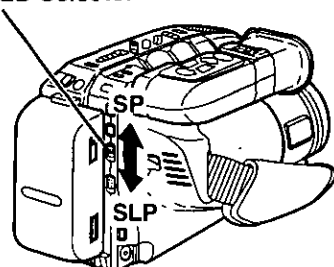

• SLP may have slightly more picture noise during playback.

Erase Protection Tab

Cassettes have a record tab to ensure that recordings are not accidentally erased.

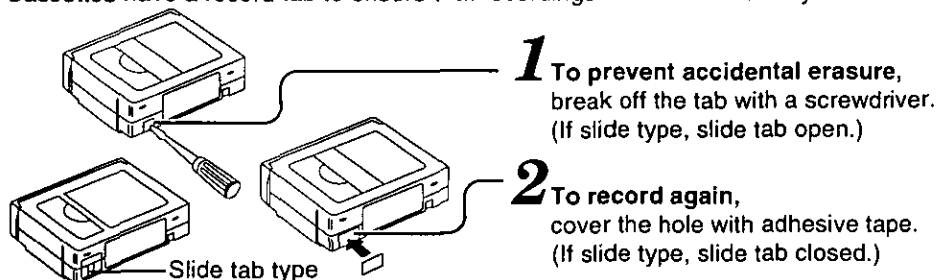

MENU Mode Setting

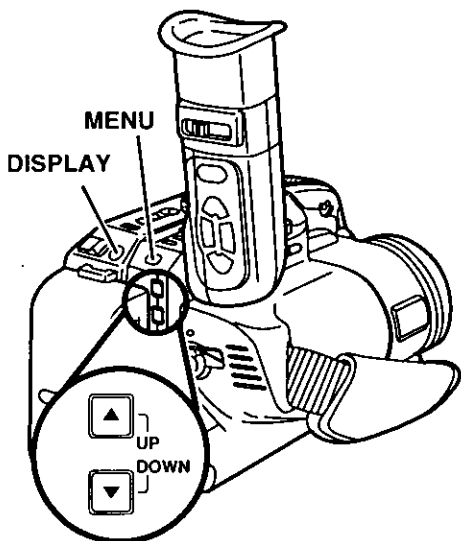

Before you begin...

- Connect the Camcorder to a power source.
- Set the POWER switch to CAMERA.

1 Press the MENU button to display the MENU mode.

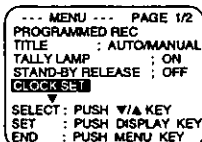

2 Press UP ▲ or DOWN ▼ repeatedly to select a menu item.

3 Press the DISPLAY button to set your selection.

4 Press the MENU button to exit the Menu mode.

Note:

- The Camcorder will exit the Menu mode if, after activation, none of the UP/DOWN(▲/▼), DISPLAY, or MENU buttons are pressed within 5 minutes.

MENU Mode Screen

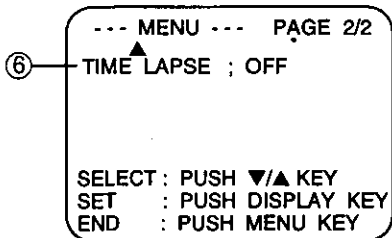
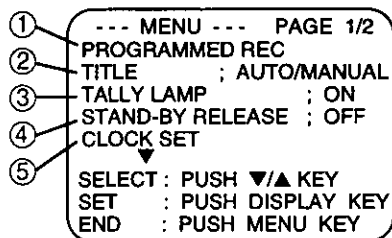

① **PROGRAMMED REC** (see page 27).
You can program the Camcorder to start and stop recording at a preset time.

② **TITLE** (see pages 47~49).
AUTO/MANUAL : 16 items
PHRASE : 10 items

③ **TALLY LAMP** (see page 46).
The Tally Lamp comes on during recording when set to ON.

④ **STAND-BY RELEASE** (see page 25).
To resume recording from Stand-by mode, when set to ON.

⑤ **CLOCK SET** (see pages 14~16).
To set the clock, select CLOCK SET.

⑥ **TIME LAPSE** (see page 45).
To set the TIME LAPSE, when set to ON.

Setting the Clock

Setting the clock is divided into four sections: Time Zone, Daylight Saving Time, Date and Time, and Clock Battery. Follow instructions in the order presented.

Setting the Time Zone

The Camcorder is set to Eastern time zone at the factory. If you live, or are traveling, in a different time zone, follow the steps to select the appropriate time zone from the menu screen.

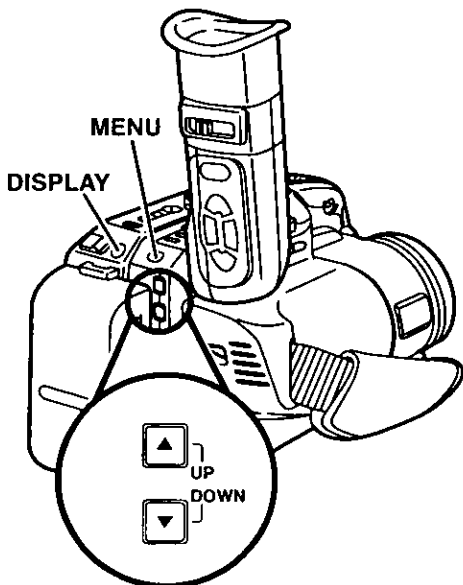

Time Zone chart

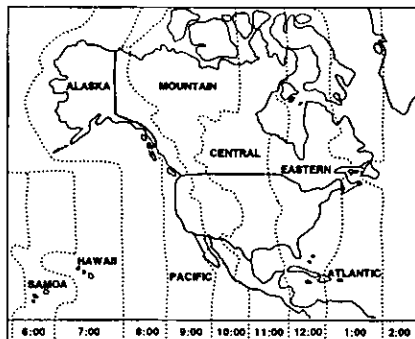

Note:

When you travel outside the eight time zone chart above, please set the clock manually (see page 16).

Before you begin...

- Connect the Camcorder to a power source.
- Set the POWER switch to CAMERA.

Note:

- When the POWER switch is set to VCR, the CLOCK SET menu will be displayed.
- The Camcorder's clock may lose or gain up to two minutes per month. Please adjust as necessary (refer to page 16).

1 Press the MENU button to display the MENU mode. Press UP ▲ or DOWN ▼ repeatedly to select **CLOCK SET**.

```
... MENU ... PAGE 1/2
PROGRAMMED REC
TITLE      : AUTOMANUAL
TALLY LAMP : ON
STAND-BY RELEASE : OFF
CLOCK SET
↓
SELECT : PUSH V/A KEY
SET    : PUSH DISPLAY KEY
END    : PUSH MENU KEY
```

2 Press the DISPLAY button to display the CLOCK SET menu. Press UP ▲ or DOWN ▼ repeatedly to select **TIME ZONE**.

```
... CLOCK SET ...
TIME ZONE : EASTERN
D. S. T.   : AUTO
DATE / TIME : 12:00:00AM
              JAN 1 1998
SELECT : PUSH V/A KEY
SET    : PUSH DISPLAY KEY
END    : PUSH MENU KEY
```

3 Press the DISPLAY button to display the SELECT TIME ZONE menu. Press UP ▲ or DOWN ▼ repeatedly to select desired time zone.

```
... SELECT TIME ZONE ...
ATLANTIC  PACIFIC
EASTERN ALASKA
CENTRAL  HAWAII
MOUNTAIN SAMOA
SELECT : PUSH V/A KEY
SET    : PUSH DISPLAY KEY
```

4 Press the DISPLAY button to fix the Time Zone. The CLOCK SET menu appears. Press the MENU button to display the MENU.

To exit from the MENU mode, press the MENU button.

Setting the Clock

Setting the Daylight Saving Time

The clock will automatically adjust to daylight saving time.

The Camcorder is preset to Daylight Saving Time **AUTO**. If you do not want the clock to be automatically adjusted to daylight saving time, please select **OFF** by following steps 1-4.

Before you begin...

- Connect the Camcorder to a power source.
- Set the POWER switch to CAMERA.

Note:

- When the POWER switch is set to VCR, the CLOCK SET menu will be displayed.
- Daylight saving time feature will not function if time zone is set to Hawaii or Samoa.

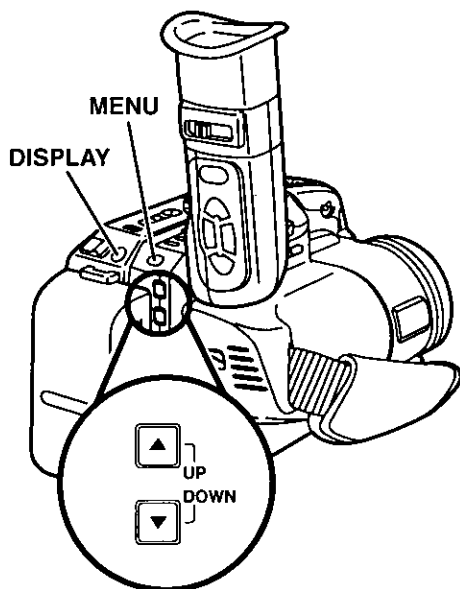

Spring (First Sunday in April):

In DAYLIGHT SAVING TIME: AUTO mode, the clock is automatically moved ahead one hour.

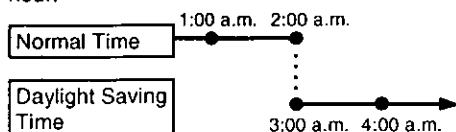

Autumn (Last Sunday in October):

In DAYLIGHT SAVING TIME: AUTO mode, the clock is automatically turned back one hour.

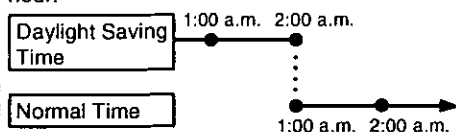

- 1 Press the MENU button to display the MENU mode. Press UP ▲ or DOWN ▼ repeatedly to select **CLOCK SET**.

```
--- MENU --- PAGE 1/2
PROGRAMMED REC
TITLE      : AUTOMANUAL
TALLY LAMP : ON
STAND-BY RELEASE : OFF
CLOCK SET
↓
SELECT : PUSH ▼/▲ KEY
SET    : PUSH DISPLAY KEY
END    : PUSH MENU KEY
```

- 2 Press the DISPLAY button to display the CLOCK SET menu. Press UP ▲ or DOWN ▼ repeatedly to select **D. S. T.**

```
--- CLOCK SET ---
TIME ZONE : EASTERN
D.S.T.   : AUTO
DATE/TIME : 12:00:00AM
          JAN 1 1998
SELECT : PUSH ▼/▲ KEY
SET    : PUSH DISPLAY KEY
END    : PUSH MENU KEY
```

- 3 Press the DISPLAY button to display the DAYLIGHT SAVING TIME menu. Press UP ▲ or DOWN ▼ to select AUTO or OFF.

```
-- DAYLIGHT SAVING TIME --
AUTO
OFF
SELECT : PUSH ▼/▲ KEY
SET    : PUSH DISPLAY KEY
```

- 4 Press the DISPLAY button to fix the DAYLIGHT SAVING TIME setting. The CLOCK SET menu appears. Press the MENU button to display the MENU.

To exit from the MENU mode, press the MENU button.

Setting the Clock

Setting the Date and Time

The date and time are calculated, including leap year, up to DEC 31 2096.

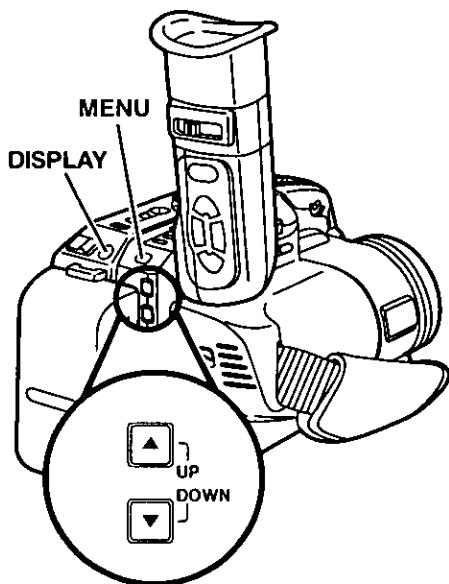

Before you begin...

- Connect the Camcorder to a power source.
- Set the POWER switch to CAMERA.

Note:

- When the POWER switch is set to VCR, the CLOCK SET menu will be displayed.

- 1 Press the MENU button to display the MENU mode. Press UP ▲ or DOWN ▼ repeatedly to select **CLOCK SET**.

```
--- MENU --- PAGE 1/2
PROGRAMMED REC
TITLE : AUTOMANUAL
TALLY LAMP : ON
STAND-BY RELEASE : OFF
CLOCK SET
↓
SELECT : PUSH ▼/▲ KEY
SET : PUSH DISPLAY KEY
END : PUSH MENU KEY
```

- 2 Press the DISPLAY button to display the CLOCK SET menu. Press UP ▲ or DOWN ▼ repeatedly to select **DATE/TIME**.

```
--- CLOCK SET ---
TIME ZONE : EASTERN
D. S. T. : AUTO
DATE/TIME : 12:00:00AM
JAN 1 1998
SELECT : PUSH ▼/▲ KEY
SET : PUSH DISPLAY KEY
END : PUSH MENU KEY
```

- 3 Press the DISPLAY button to display the DATE/TIME SETTING menu.

```
--- DATE/TIME SETTING ---
-12:00:00AM-
JAN 1 1998
SELECT : PUSH ▼/▲ KEY
SET : PUSH DISPLAY KEY
```

- 4 Press UP ▲ or DOWN ▼ repeatedly (or hold down) to enter the desired numbers, then press the DISPLAY button to fix that portion and move on. Adjust the flashing digits for the hour, minute, month, day, and year.

When you finish setting the year, the clock starts operating, and the CLOCK SET menu appears.

Press the MENU button to display the MENU.

To exit from the MENU mode, press the MENU button.

EXAMPLE

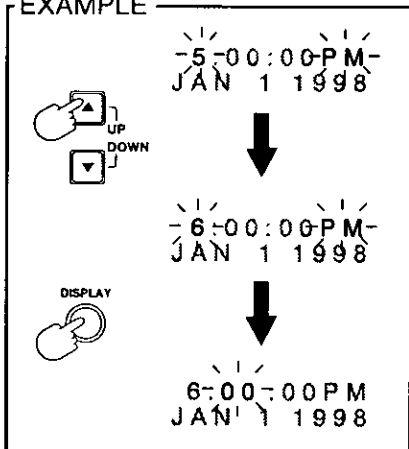

Replacing the Battery

The date and time operates on a miniature battery preinstalled in the underside of your Camcorder.

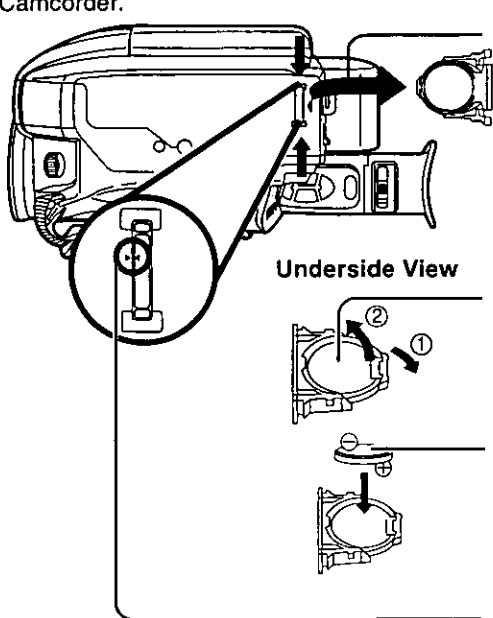

1 While pinching the stopper tabs, pull the Battery Tray out of the Battery Compartment.

2 Remove the Battery by bending the locking tab outward.

3 Place the new Battery into the Battery tray with the ⊕ mark facing down. Press down until it snaps into place.
• Do not reverse the polarity.

4 Insert the Battery Tray until both triangle marks meet.

WARNING:

Replace battery with Panasonic PART NO. VSBW0004 (CR2025) only. Use of another battery may present a risk of fire or explosion. Caution-battery may explode if mistreated. Dispose of used battery promptly. Keep away from children. Do not recharge, disassemble or dispose of in fire.

Note:

- Make sure your Camcorder is off when replacing the Battery.
- Keep the Battery out of the reach of children as swallowing it may be harmful.
- Improperly installed, discharged, or missing battery will cause "CLOCK BATTERY" to appear when the DISPLAY button is pressed.
- Battery life is approximately 5 years.

Electronic Viewfinder/LCD Monitor Indications

Tape/Battery Remaining

The tape remaining and battery charge level can be displayed during recording.

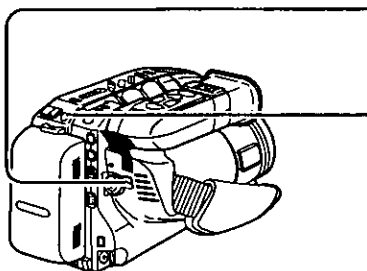

1 Set the POWER switch to CAMERA.

2 Press DISPLAY repeatedly to select the desired display.

EVF/LCD Monitor Indications

Battery Charge Remaining:

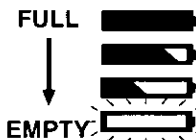

Tape Remaining:

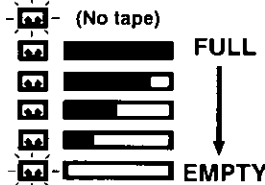

- It will take several seconds for the tape remaining indicator to operate after the tape starts moving.

Recording the Date and Time

1 Set the POWER switch to CAMERA. When placed in Record mode, the time and date will be recorded on the tape.

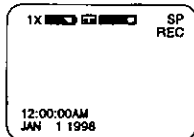

2 Press DISPLAY twice to change the display to date only. Press once or twice more to remove the date/time display.

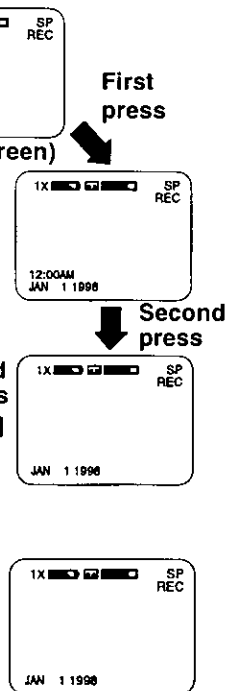

Note:

Only the Date and/or Time indications are recorded on the Tape.

Display-Off Mode

This feature allows you to remove all Electronic Viewfinder/LCD Monitor Indications except Intelligent Titler (see pages 47-49).

Before inserting a tape, press DISPLAY and STOP together for more than one second to remove the indications except time and date*.

To display the Indications again, turn the Camcorder Power off and then on again.

* To remove the time and date, press the DISPLAY button repeatedly.

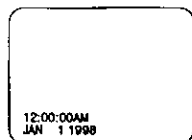

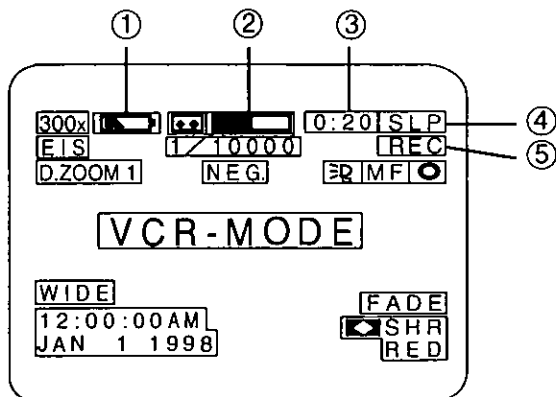

Electronic Viewfinder/LCD Monitor Indications



① **Battery Remaining Indication**  (see page 18)

When a battery recharge is necessary, "WARNING LOW BATTERY" will appear in the EVF. The external Power Lamp will start to flash and the Camcorder will automatically turn OFF in 15 seconds.

② **Tape Remaining Indication**

- If the Camcorder is in the camera mode (RECORD), with no cassette tape inserted, or the record tab is missing,  will flash for one minute and "CHECK TAPE" will appear for 5 seconds.
- As the tape reaches the end during recording,  will flash and "TAPE END" will appear for 5 seconds as a warning.

③ **10-Second Reminder**

An elapsed time indicator appears one second for every 10 seconds that recording continues. This is a reminder of how long you have been shooting a particular scene and can help keep your recordings fresh and interesting.

0:00 0:10 0:20 59:50

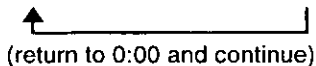

- The 10-Second Reminder will reset to 0:00 whenever you press the RECORD/PAUSE button.

④ **TAPE SPEED Indication** (see pages 12, 45)

Indicates the tape speed (SP or SLP or T.LAPSE).

⑤ **Operating Mode Indications**

REC (record)

(Appears in large then small characters.)

PAUSE

(Appears in large then small characters.)

FF (fast forward)

PLAY

REW (rewind)

Electronic Viewfinder/LCD Monitor Indications

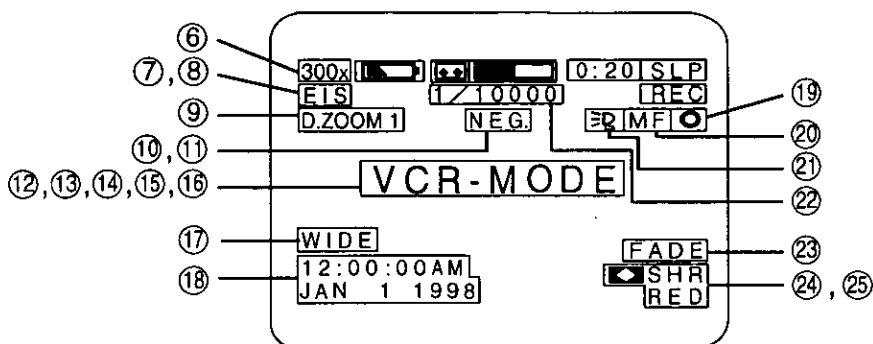

- ⑥ Zoom Magnification level (see page 33).
- ⑦ Digital E.I.S. Indication (see page 40).
- ⑧ Digital Wipe Indication (see page 42).
- ⑨ Digital Zoom Indication (see page 39).
- ⑩ Negative/Positive Indication (see page 38).
- ⑪ Still/Strobe Indication (see page 41).
- ⑫ VCR-MODE Indication
Appears for one minute if the POWER switch is set to VCR or the RECORD/PAUSE button is pushed in VCR MODE.
- ⑬ DEW Indication
If excessive moisture condenses in the unit, "WARNING DEW DETECTED" will appear, Power Lamp will flash, and the Camcorder will automatically turn OFF in 15 seconds.
Wait until the indicator no longer flashes when your Camcorder is turned on before use.
- ⑭ Time Lapse Indication (see page 45).
- ⑮ Security Mode Indication (see page 43).
- ⑯ Message Mode Indication (see page 50).
- ⑰ Wide Screen Indication (see page 41).
- ⑱ Date and Time Indication (see page 16).
- ⑲ Backlight Indication (see page 33).
- ⑳ Manual Focus Indication (see page 34).
- ㉑ Light ON/OFF Indication (see page 22).
- ㉒ High Speed Shutter Indication (see page 35).
- ㉓ Fade Indication (see page 36).
- ㉔ Color Digital Fade Indication (see page 37).
- ㉕ Color Digital Filter Indication (see page 38).

Attaching the Shoulder Strap and Remote Control Holder

Make sure the Battery Pack is not attached.

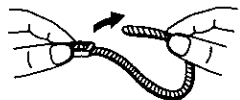

1 Undo the two strap ends from their buckles.



2 Remove the buckle from one end of the strap.

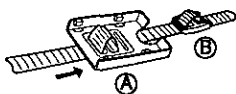

3 Ⓐ Thread the strap (with no buckle) through the Control Holder so that it faces outward.
Ⓑ Then reinsert the buckle.

Ⓑ Then reinsert the buckle.

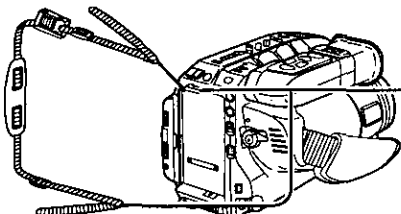

4 Thread the strap ends through the Strap Attachment Rings.



5 Reinsert the strap ends through their buckles.

min. 1 inch (25.4mm)

• Make sure the straps are not twisted.

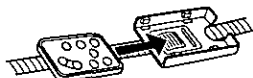

6 Insert the Remote into the Remote Control Holder for storage.

Adjusting the Length

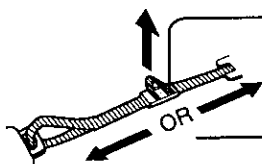

1 Pull a loop of the strap loose from the buckle.

2 Pull the strap firmly through the buckle to shorten or lengthen the strap.

Hand Strap

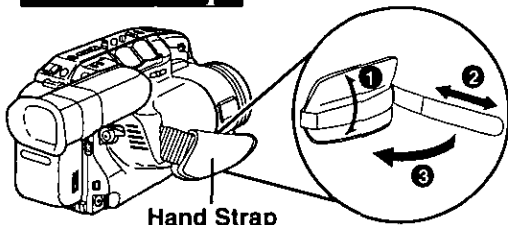

Hand Strap

Adjust the length of the Hand Strap to the size of your hand as illustrated.

Built-in Auto Light

Using the Built-in Auto Light

To improve recording indoors or outdoors in dim lighting conditions.

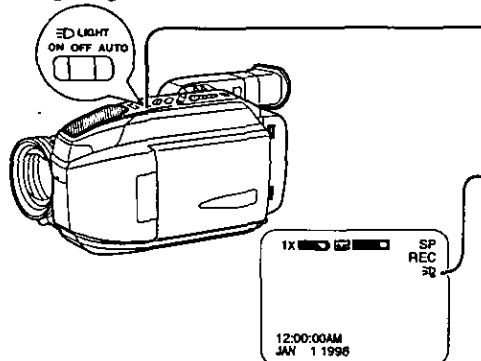

Before you begin...

- Connect the Camcorder to a power source.
- Set the POWER switch to CAMERA.

Set the LIGHT switch to AUTO.

The built-in light automatically turns on and off depending on lighting conditions.

Or set LIGHT to ON/OFF to turn the light on and off manually.

☞ will appear in the EVF while the light is turned on.

Caution:

This light becomes hot during operation. Make sure nothing covers the Light during operation.

Replacing the Bulb

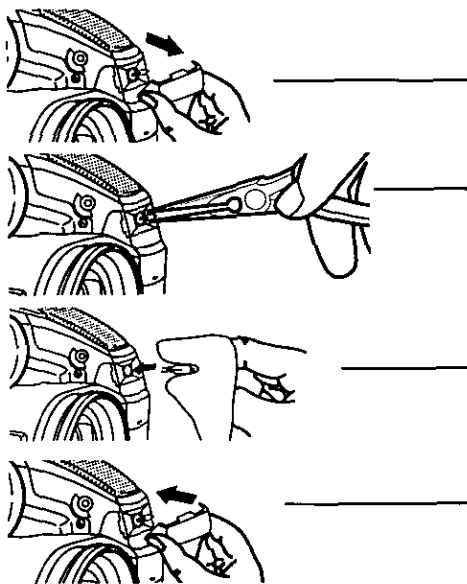

Before you begin...

- Set the POWER switch to OFF.
- When ordering replacement bulbs, use PART No. VULS0001

1 Push in on the both sides of the lens cover to unlock and pull it straight out from the Camcorder.

2 Using Tweezers or Needle-nose pliers, carefully remove the bulb from the Camcorder.

- If you have trouble replacing the bulb, please take the unit to your nearest service center for assistance.

3 Using a clean cloth or tissue, replace the bulb.

4 Push the lens cover straight back into place.

Note:

- Using the light reduces battery operating time.
- If using the Built-in Light in a hot environment for an extended period of time, be sure to provide ventilation.
- Using the Built-in Light when the Camcorder is powered by a car battery may shorten bulb life.
- Be sure LIGHT switch is set to OFF when not in use or before placing Camcorder into an optional carrying case.
- Be very gentle when handling the bulb. Excessive force may cause the bulb to crack.

DANGER:

When replacing the bulb, use only lamp bulbs (PART NO. VLLW0015) supplied by Panasonic to reduce the risk of fire.

Use a cloth or tissue when handling the bulb as finger oils will decrease the bulb life.

To prevent possible burn hazard, remove the lens cover and allow the lamp to cool before replacing.

Camera Recording

Simple Recording

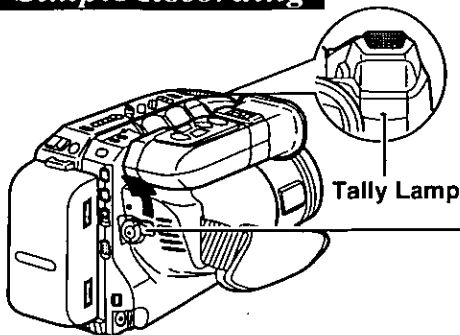

Before you begin...

- Connect the Camcorder to a power source.
- Insert a cassette with record tab (see page 12).

1 Set the POWER switch to CAMERA. The built-in Lens Cover opens.

EVF

- Make sure the POWER switch is fully rotated to the CAMERA position.

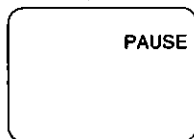

Record/Pause mode.

2 With the Viewfinder Eye Cup against your eye, adjust the Vision Adjustment Control to your eyesight.

3 Slide the TAPE SPEED Selector to SP or SLP (refer to page 12).

4 Press RECORD/PAUSE to start recording. The Tally Lamp and REC Indicator are lit during recording.

TAPE
EJECT

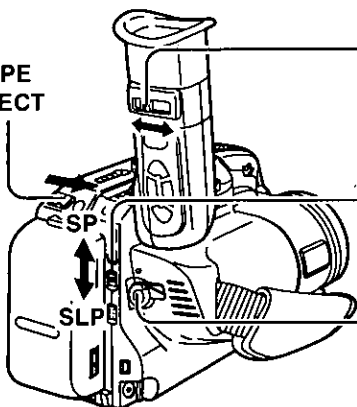

WARNING:

- Do not leave the Camcorder with the EVF aimed directly at the sun as this may cause damage to the internal parts of the EVF.

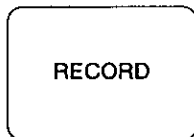

Press the RECORD/PAUSE again to pause the recording.

Set the Power switch to OFF after recording is finished.

• To remove the cassette

In Record/Pause mode, slide the TAPE EJECT switch (refer to page 12).

- When your Camcorder is aimed at excessively bright objects, or bright lights, a vertical bar may appear in the picture. This is a normal characteristic of the CCD pick-up device. Try to avoid this when possible.

Camera Recording

Using the LCD Monitor

The LCD (Liquid Crystal Display) monitor can be used while recording.

Before you begin...

- Connect the Camcorder to a power source.

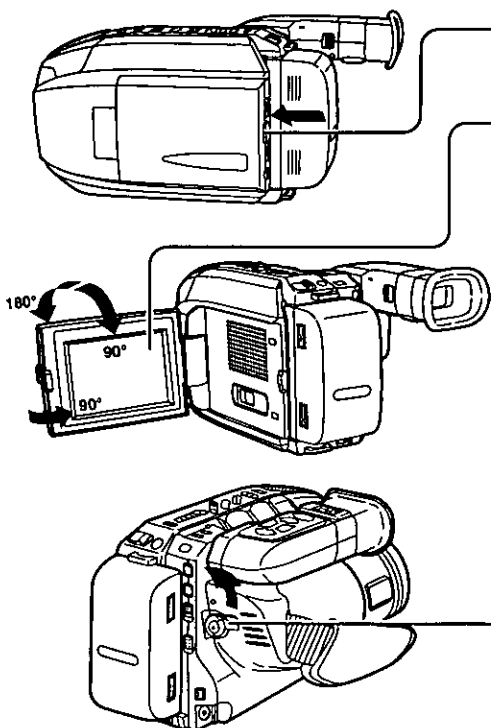

1 Press the LCD-OPEN button to unlock the LCD monitor.

2 Swing the LCD monitor fully open and adjust the angle.

Caution:

Rotating the LCD monitor while it is only partially open may block the cassette door and cause damage to the Camcorder body.

3 Set the POWER switch to CAMERA.

- The LCD monitor turns on and off according to the POWER switch setting.
- When the LCD monitor is fully open, the Viewfinder automatically turns OFF.
- When the LCD monitor is completely closed, the Viewfinder turns on automatically.
- By rotating the LCD monitor 180°, so that it faces the same direction as the lens, the Viewfinder turns back on allowing you and the subject to monitor the recording.

4 Rotate the BRIGHT control to adjust the brightness of the LCD monitor.

5 Start recording (see page 23).

Note:

- Using the LCD monitor reduces battery operating time.
- You cannot monitor the sound from the speaker during recording. Connect the earphone (M3 type, not supplied) to PHONE (earphone) jack and adjust the volume of the earphone using the VOLUME control.
- Close the LCD monitor completely when not in use.

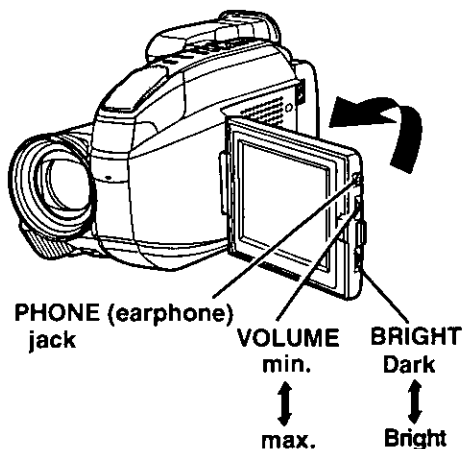

Stand-by Quick Release

Whenever the Camcorder is left in RECORD/PAUSE mode for 5 minutes, it will automatically switch to Stand-by mode to conserve energy. Activating the Stand-by Quick Release feature allows you to release the Stand-by mode and resume recording by simply pressing the RECORD/PAUSE button. If this feature is not activated, it is necessary to turn the Camcorder OFF, and then back to CAMERA to start recording again. The default setting from the factory is OFF mode.

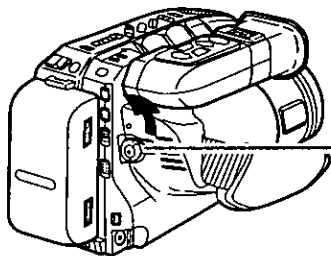

Before you begin...

- Connect the Camcorder to a power source.
- Insert a cassette with record tab (see page 12).

1 Set the POWER switch to CAMERA.

2 Press the MENU button to display the MENU mode. Press UP ▲ or DOWN ▼ repeatedly to select **STAND-BY RELEASE**.

---	MENU	---	PAGE 1/2
PROGRAMMED REC			
TITLE	:	AUTO/MANUAL	
TALLY LAMP	:	ON	
STAND-BY RELEASE	:	ON	
CLOCK SET	:		
SELECT	:	PUSH ▼/▲ KEY	
SET	:	PUSH DISPLAY KEY	
END	:	PUSH MENU KEY	

3 Press the DISPLAY button to set ON or OFF.

ON:

You can resume recording from Stand-by mode by pressing the RECORD/PAUSE button.

OFF:

You must set the POWER switch to OFF, and then to CAMERA to release the Stand-by mode.

4 Press the MENU button to set your selection and exit the Menu mode.

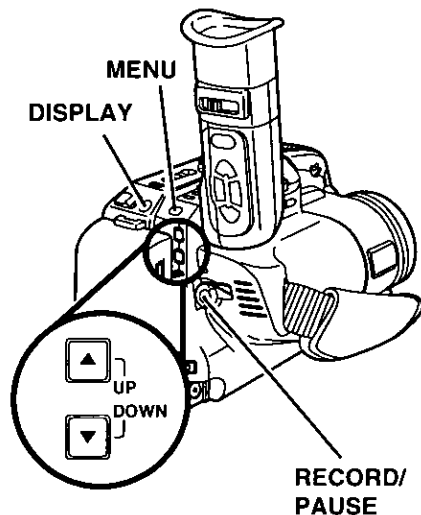

Camera Recording

Easy Edit Stand-by

If you stop recording but plan to resume within 24 hours, use the Edit Standby feature to make a smooth transition between scenes.

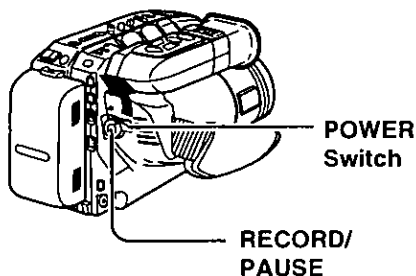

- 1** Press RECORD/PAUSE while recording.
- 2** Set the POWER switch to OFF and leave the cassette in the Camcorder.
- 3** When ready to resume recording, set the POWER switch to CAMERA and press RECORD/PAUSE.

Note:

- If it is going to be longer than 24 hours before you resume recording, you will need to use the manual Easy Edit feature described below.

Manual Easy Editing

For proper continuity when taping from the Stop mode, or after changing the Battery Pack.

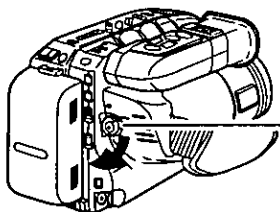

- 1** Set the POWER switch to VCR.

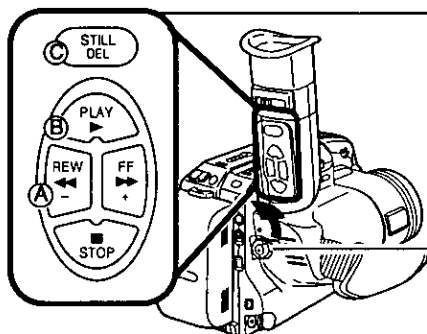

- 2**
 - A** Press REWIND/SEARCH to go back a few seconds on the tape.
 - B** Press PLAY to review the picture on the Viewfinder.
 - C** Press STILL at the location you wish to continue your recording.

- 3** Set the POWER switch to CAMERA.

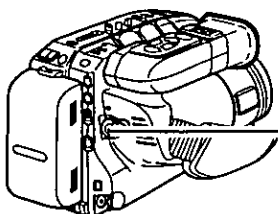

- 4** Press RECORD/PAUSE to continue recording.

Camera Recording

Programmed Recording

You can program the Camcorder to start and stop recording at a preset time. You can also do an Interval Recording which allows you to record 5 or 10 second intervals per minute.

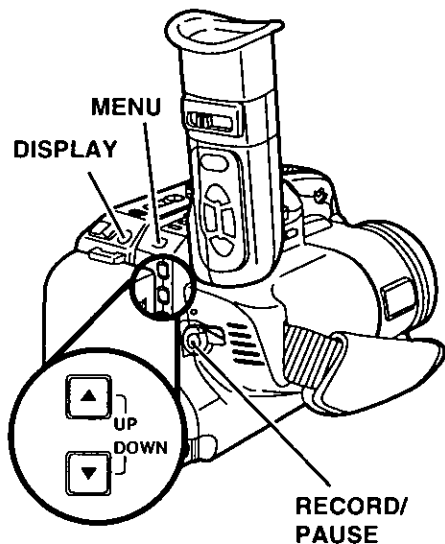

10MIN. → 20MIN. → 30MIN. → TO TAPE END	
INTERVAL *2 10 SEC/MIN.	INTERVAL *1 5 SEC/MIN.

***1 Interval 5 SEC/MIN:**
A 5 second recording is performed each minute.

***2 Interval 10 SEC/MIN:**
A 10 second recording is performed each minute.

Note:

- The start time cannot be set for over 24 hours in advance from the current time.
- The Camcorder will automatically shut itself off when the tape reaches its end or 12 hours after an Interval recording is started.
- Set the POWER switch to OFF to cancel the Programmed Recording feature.

Before you begin...

- Connect the Camcorder to a power source. For extended periods of recording, it is recommended to use the AC Adaptor for a power source.
- Insert a cassette with record tab (see page 12).
- Set the POWER switch to CAMERA.

1 Press the MENU button to display the MENU mode. Press UP ▲ or DOWN ▼ repeatedly to select **PROGRAMMED REC**.

```
--- MENU --- PAGE 1/2
PROGRAMMED REC
TITLE          : AUTOMANUAL
TALLY LAMP     : ON
STAND-BY RELEASE : OFF
CLOCK SET
SELECT : PUSH ▼/▲ KEY
SET    : PUSH DISPLAY KEY
END    : PUSH MENU KEY
```

2 Press the DISPLAY button to display the current time in the EVF. To change the start time, press the DISPLAY button repeatedly. Each press increases the time by 30 minutes.

```
START: 10:20PM
REC TIME: 10MIN.
SELECT : PUSH ▼/▲ KEY
SET    : PUSH DISPLAY KEY
START  : PUSH REC/PAUSE
CANCEL : PUSH MENU KEY
10:20:00PM
```

3 Press DOWN ▼ to select **REC TIME**. Press the DISPLAY button repeatedly to select one of the recording lengths shown at left.

```
START: 10:30PM
REC TIME: 10MIN.
SELECT : PUSH ▼/▲ KEY
SET    : PUSH DISPLAY KEY
START  : PUSH REC/PAUSE
CANCEL : PUSH MENU KEY
10:20:00PM
```

If you want to cancel the setup, press the MENU button twice.

4 After setting the START and REC TIME, press the REC/PAUSE button to place the Camcorder in stand-by mode.

```
STAND-BY
START: 10:30PM
REC TIME: 10MIN.
10:20:00PM
JUN 1 1998
```

The Camcorder will automatically start recording at the preset time and turn itself off when the recording is finished.

8-Function Remote Control

To Store Your Remote Control

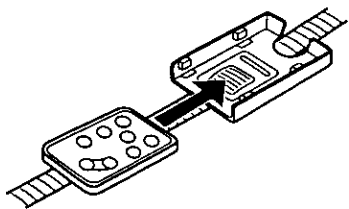

This holder (supplied) can be attached to the shoulder strap (see page 21). When the Remote is not in use, slide it into the holder as shown.

Remote Control Operation

Operate the major functions of your Camcorder from up to 16 feet (5 m) (approx.) away. Aim the Remote Control at the Remote Sensor of the Camcorder and press the desired buttons.

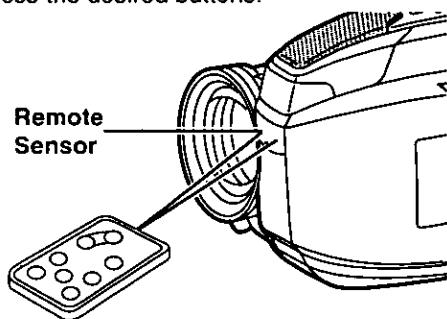

Controlled Functions

Rec/Pause (see page 23)
T (telephoto) Zoom
W (wide angle) Zoom
Play (see page 29)
Fast Forward/Search (see page 30)
Rewind/Search (see page 29)
Stop (see page 29)
Still (see page 30)

Important Note:

- After 5 minutes in the Rec/Pause mode, the Camcorder will shut off to conserve battery life. If Camcorder is needed within 30 minutes, press the REC/PAUSE button down for about one second. This will resume power in the Record mode. If more than 30 minutes have elapsed, set the POWER switch to OFF and then back to CAMERA before recording again.

Replace the Battery

Replace battery with Panasonic PART NO. VSBW0004 (CR2025) only. Use of another battery may present a risk of fire or explosion. Caution-battery may explode if mistreated. Dispose of used battery promptly. Keep away from children. Do not recharge, disassemble or dispose of in fire.

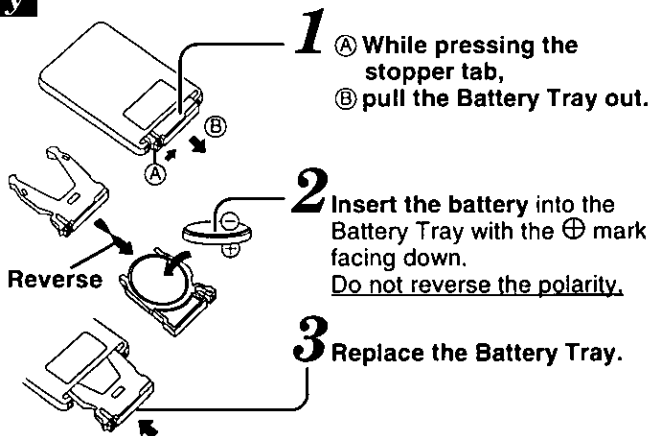

1 While pressing the stopper tab, pull the Battery Tray out.

2 Insert the battery into the Battery Tray with the ⊕ mark facing down. Do not reverse the polarity.

3 Replace the Battery Tray.

Playing Back your Recordings

Playback using the EVF or LCD Monitor

Before you begin...

- Connect the Camcorder to a power source.
- Insert a recorded cassette.

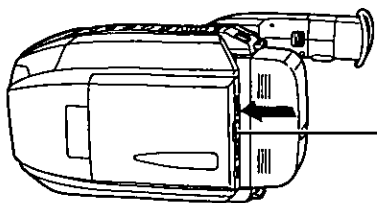

1 Press the LCD-OPEN button to unlock the LCD monitor and swing it open.

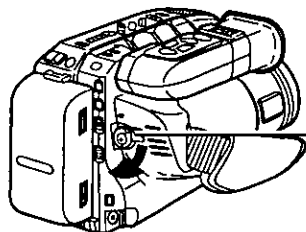

2 Set the POWER switch to VCR.

- The LCD monitor turns on and off according to the POWER switch setting.
- When the LCD monitor is fully open, the Viewfinder automatically turns OFF.
- When the LCD monitor is in the closed position, you can view your recording through the EVF.
- When not in use, close the LCD monitor so that it faces inward.

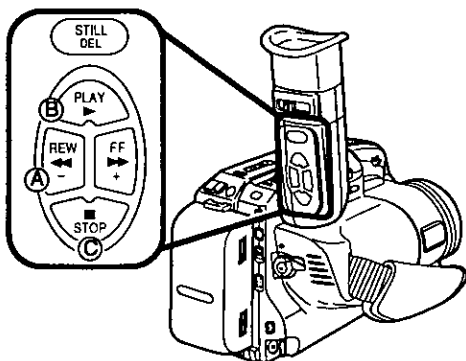

3 Start Tape Playback.

- Ⓐ Press the REWIND/SEARCH button to rewind the tape.
- Ⓑ Press PLAY to start playback.
- Ⓒ Press STOP to stop playback.
- Adjust the volume of the speaker or earphone (if connected) using the VOLUME control.
- Adjust the brightness of the LCD monitor using the BRIGHT control.

Auto Play

When the POWER switch is set to VCR, playback will automatically begin if the record tab has been removed on the cassette.

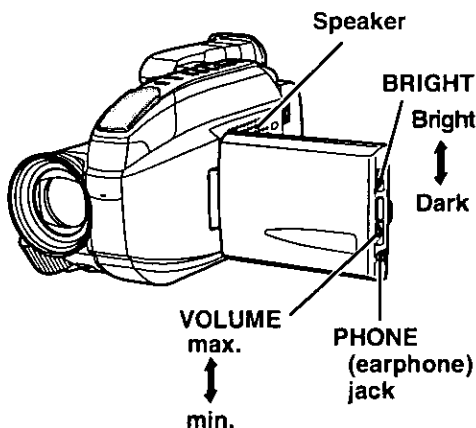

4 When you are finished viewing, close the LCD monitor completely. (The EVF will turn on.)

Note:

- Using the LCD monitor reduces battery operating time.
- If you connect the earphone (M3 type, not supplied) to PHONE (earphone) jack, the sound from the speaker will be muted.

Playing Back your Recordings

Special Effects Playback

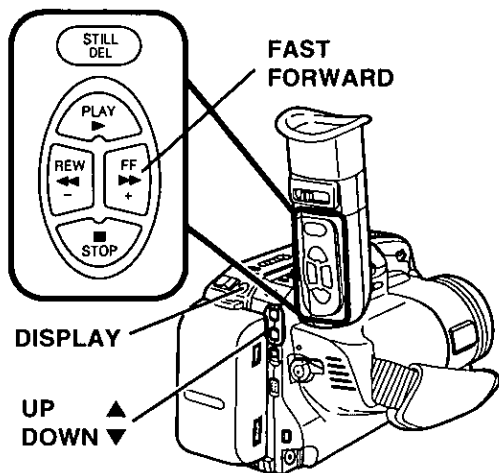

Before you begin...

- Connect the Palmcorder to a power source.
- Insert a recorded cassette.
- Set the POWER switch to VCR.

To rapidly locate a scene

Press **PLAY** then press **FAST FORWARD/SEARCH** or **REWIND/SEARCH** for rapid visual search. Press again, or press **PLAY** to resume normal speed.

View a Still Picture

Press **STILL** to freeze the picture. Press again to resume normal playback.

Search Speed

Standard Play (SP) Search is about 3 times the normal speed, and Super Long Play (SLP) Search is about 9 times the normal speed.

Note:

- During search playback, horizontal noise bars will appear and there will be no audio.
- To protect the tape and the video heads, your Palmcorder's operating modes will revert as follows:
STILL → STAND-BY after 5 minutes.
STANDBY → POWER OFF after 5 minutes when using a Battery Pack.
- When the tape reaches its end during playback, or fast forward, it will rewind automatically.

Tracking Control

Auto Tracking

Continuously analyzes the signal of each recording for optimum picture quality.

Manual Tracking

To minimize the noise in some recordings, manual tracking may be necessary.

For Noise in Playback mode:

Press **UP ▲** or **DOWN ▼** until picture clears up.
Press **DISPLAY** to return to Auto Tracking.

For Noise in Still mode:

Press **UP ▲** or **DOWN ▼** until picture clears up.

V-Lock Control (Reduces jitter in Still mode.)

Press **DISPLAY** and **UP ▲** or **DOWN ▼** until picture is stable.

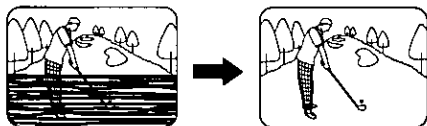

Playing Back your Recordings

TV Playback or Viewing

Your Camcorder may be connected to a TV to play back tapes or to view what you are recording.

TV with AUDIO/VIDEO IN Jacks.

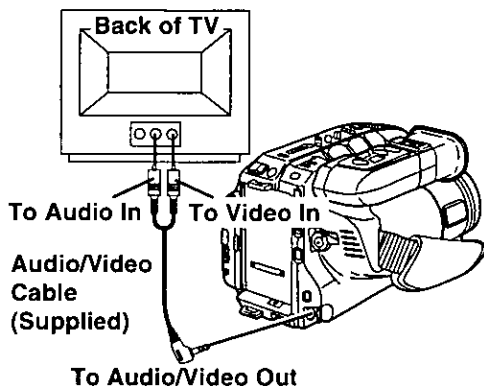

TV without AUDIO/VIDEO IN Jacks.

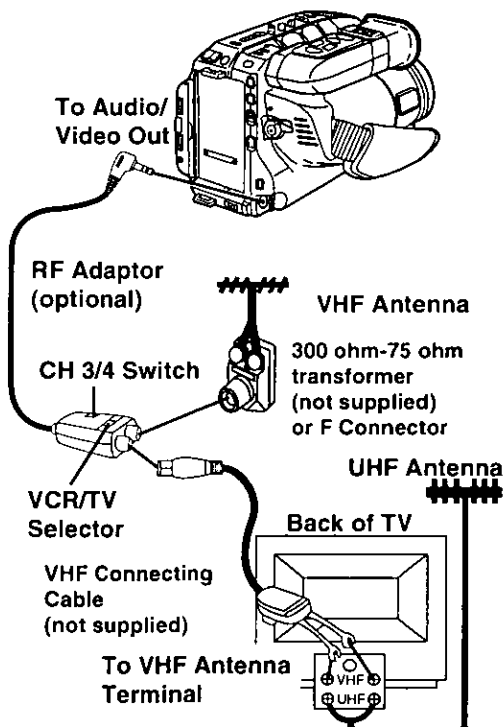

Before you begin...

- Connect the Camcorder to a power source.

1 Set the **POWER** switch to **VCR** for tape playback.
Or, set to **CAMERA** to view what your Camcorder is recording.

2 Turn the TV **ON** and set it to **LINE INPUT**.

Check your TV operating instructions.

Note:

If your TV has no VIDEO or AUDIO IN jacks, select CH 3 or 4 on your TV to match the CH 3/4 switch setting on the OPTIONAL PV-RF16 RF Adaptor. Set the VCR/TV selector on the RF Adaptor to VCR for playback.

3 Start playback or begin a recording.

If you have connected the Camcorder to your TV using the PV-RF16 RF Adaptor and want to watch TV only:

Set the **POWER** switch to **OFF** on the Camcorder.

Then, set the **VCR/TV Selector** on the RF Adaptor to **TV**.

Now, turn the TV **ON** and select a channel.

CATV System Installer

This reminder is provided to call the CATV system installer's attention to Article 820-40 of the NEC in USA (and to the Canadian Electrical Code in Canada) that provides guidelines for proper grounding and, in particular, specifies that the cable ground shall be connected to the grounding system of the building, as close to the point of cable entry as practical.

Playing Back your Recordings in your VCR

Playback using the PlayPak

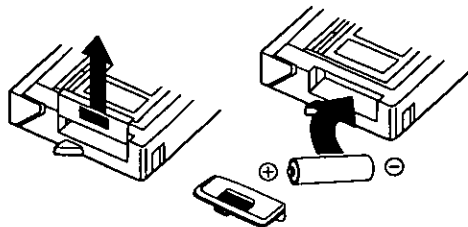

Remove the Battery Compartment lid and insert the AA size battery.

- Make sure polarities are aligned properly.
- When tape loading and unloading time becomes longer than normal, battery replacement is necessary.

Insert VHS Cassette

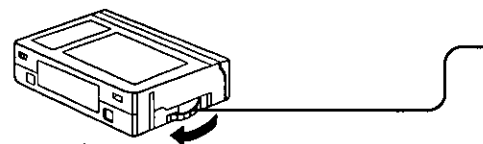

1 Turn the Tape Wheel on the **VHS** cassette in the direction of the arrow to take up any slack.

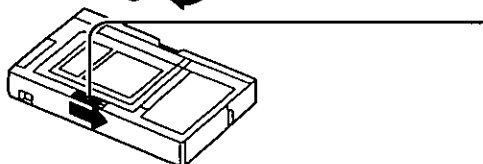

2 Slide the **RELEASE** button in the direction of the arrow to open the PlayPak door.

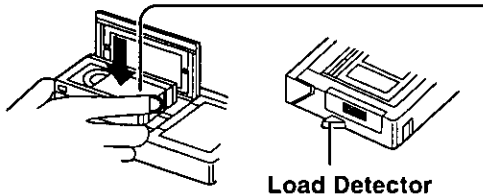

3 Insert the **VHS** cassette with the window facing up and to the left. Then, snap the lid shut.

- Be sure the cassette reel area under the PlayPak is free to turn while loading.
- Allow the Load Detector to fully retract before using the PlayPak in your standard VHS VCR.

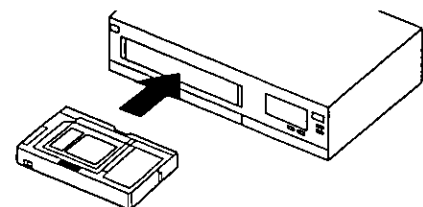

Remove VHS Cassette

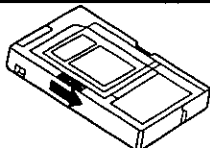

1 Slide the **RELEASE** button and wait for the lid to open.

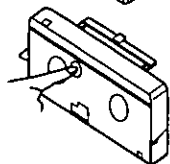

2 Hold the PlayPak securely in one hand. Using your finger, reach through the hole in the bottom of the PlayPak Adaptor and push the tape out the top.

Four-Speed Power Zoom / Backlight

Four-Speed Power Zoom

You can gradually zoom in for close ups or zoom out for wide angle shots.

The zooming speed ranges from a slow speed of 16 seconds to a fast 2 seconds according to the pressure applied to the zoom buttons.

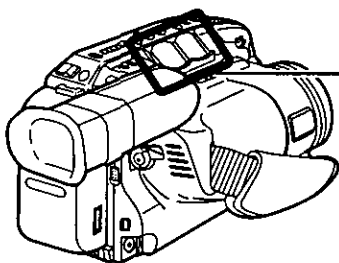

Before you begin...

- Connect the Camcorder to a power source.
- Set the POWER switch to CAMERA.

Zoom In ("T")



Zoom Out ("W")

Zoom slowly by lightly pressing the "T" (Telephoto) or the "W" (Wide Angle) side of the POWER ZOOM switch.

Zoom quickly by applying more pressure.

- The magnification level is displayed in the EVF.

Backlight

Use when recording a subject that is darker than the surrounding scene, in a shadowed area or when the light source is in the back of your subject.

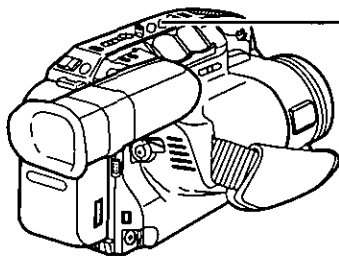

Before you begin...

- Connect the Camcorder to a power source.
- Set the POWER switch to CAMERA.

There are three levels of backlight compensation. Press the BACKLIGHT button to obtain the desired level while recording.

When lighting conditions are normal, press the BACKLIGHT button until the indicator disappears in the EVF.

EVF Indications

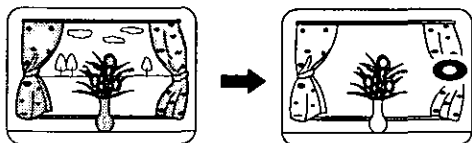

Select a level that makes the subject appear clearly in the EVF.

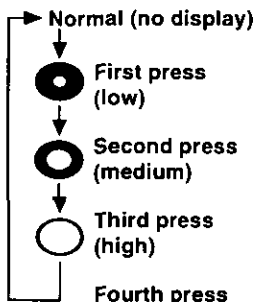

Focus

Auto Focus

The Camcorder will automatically focus on the subject even during zooming.

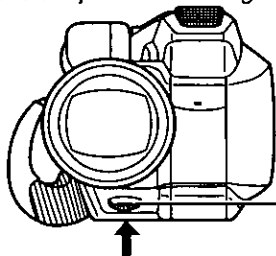

Before you begin...

- Connect the Camcorder to a power source.
- Set the POWER switch to CAMERA.

If necessary, press **MANUAL FOCUS** so that "MF" does not appear in the EVF.

Manual Focus

Use Manual Focus (MF) when recording:

- a subject through glass.
- a subject that is far from the Camcorder with objects in the foreground.
- a subject with distinct horizontal stripes.
- a subject not centered in the Viewfinder.
- a subject with a shiny surface.
- an obliquely angled subject.
- a bright, flat subject such as a white wall.
- in low light situations.
- a scene with fast motions, like a golf swing.

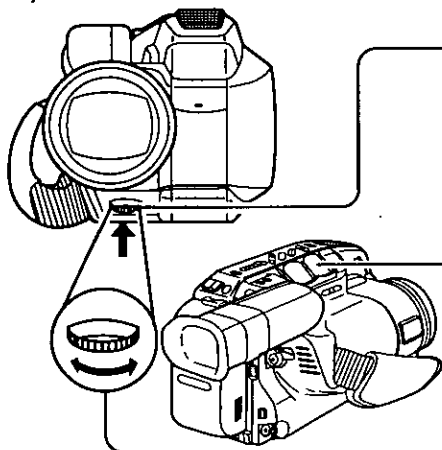

1 Press **MANUAL FOCUS** so that "MF" (Manual Focus) appears in the EVF.

EVF Indication

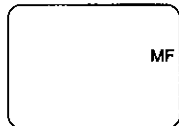

2 Press and hold the "T" side of the **POWER ZOOM** switch until the lens is zoomed in all the way (subject at maximum size).

3 Turn the **MANUAL FOCUS** control until the picture is in focus.

- It may be necessary to back away from the subject to focus the image properly.

4 Press the "W" side of the **POWER ZOOM** switch to frame the picture as desired.

- **Re-focusing may be required** when your Camcorder is aimed at a new scene.

Macro Focus (for close-ups)

Auto Focus will function as close as 1/2 inch (12.7mm) from the subject.

Press the "W" side of the **POWER ZOOM** switch to the wide angle position. Then, bring the Camcorder as close to the subject as desired.

High Speed Shutter

To record high speed motion (e.g. a tennis stroke) for improved STILL or SLOW MOTION playback, when watching the tape on this Camcorder or a VHS 3 or 4 head VCR.

Before you begin...

- Connect the Camcorder to a power source.
- Set the POWER switch to CAMERA.
- Insert a cassette with record tab (see page 12).

Auto Shutter

In the AUTO mode (no indication in the EVF), the Camcorder will automatically adjust the shutter speed from 1/60 to 1/350 according to the brightness of the subject.

- AUTO mode is automatically selected whenever the POWER switch is set to CAMERA.

Manual Selection

The High Speed Shutter indicator flashes when the light level is inadequate. More light should be provided to achieve better picture quality and color.

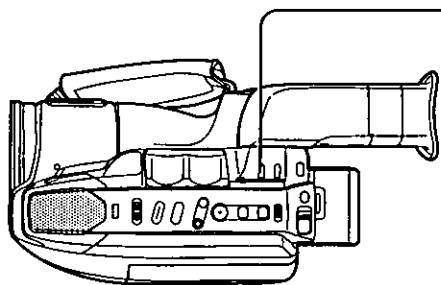

1 Press HIGH SPEED SHUTTER while recording.

2 Press repeatedly to obtain one of the eight higher shutter speeds shown below.

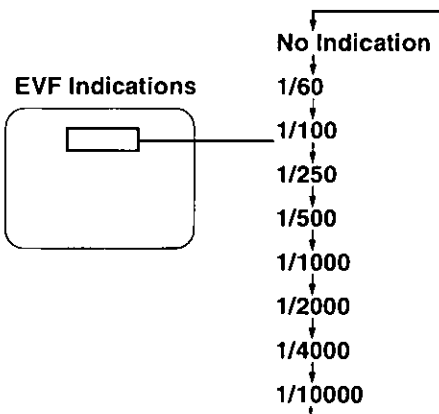

Note:

- For proper color reproduction, it is recommended that you use this feature outdoors. For indoor High Speed Shutter recording, additional halogen or tungsten light should be provided. Fluorescent light will degrade the picture quality.
- This feature requires ample light. More light is required for the fastest shutter speeds.
- The Auto Focus system may not operate properly in insufficient light when using the High Speed Shutter.

Fade

One-Touch Auto Fade (BLACK or WHITE only)

Make smooth scene transitions for a more professional look.

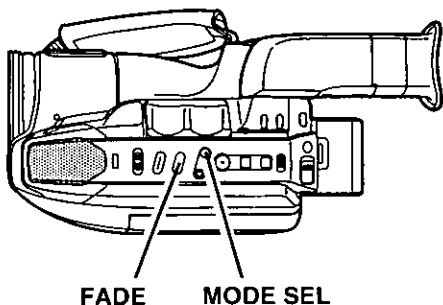

Before you begin...

- Connect the Camcorder to a power source.
- Set the POWER switch to CAMERA.

Fade In:

Starting the first scene with "fade in" can be very effective.

- 1** Press the **MODE SEL** button repeatedly to select **BLACK** or **WHITE** fade.
- 2** During the **RECORD/PAUSE** mode, press the **FADE** button to make "FADE" flash in the EVF.
- 3** Press the **RECORD/PAUSE** button. The screen will turn black and the recording will start as picture and sound gradually fade in.

Fade Out:

Use to create a soft ending or, when used together with fade in, a soft transition from one scene to the next.

- 1** Press the **MODE SEL** button repeatedly to select **BLACK** or **WHITE** fade.
- 2** Press the **FADE** button to make "FADE" flash in the EVF while recording.
- 3** Press the **RECORD/PAUSE** button. The picture and sound will gradually fade out and the recording will **PAUSE**.

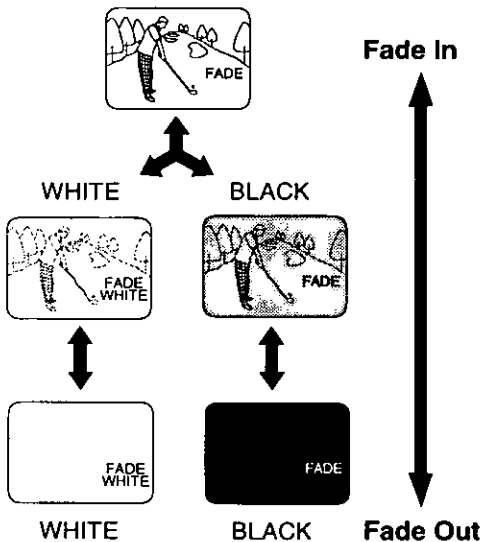

If **FADE** is accidentally pressed, simply press it again so that "FADE" disappears in the EVF.

Color Digital Fade (other than BLACK and WHITE)

This feature offers 7 fade variations in your choice of eight colors for a wide variety of fade effects.

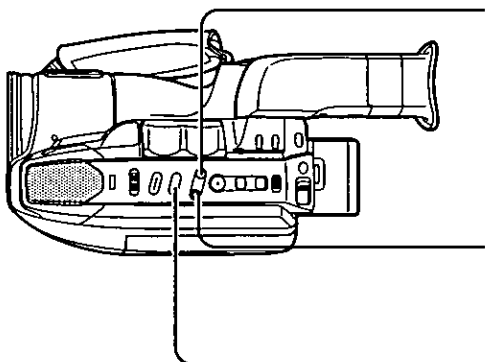

- 1** Press the **MODE SEL** button repeatedly to select the desired fade effect other than BLACK and WHITE.
 - Excluding BLACK, the mode selected will appear in the EVF.
- 2** Press the **COLOR** button to select the desired color other than BLACK or WHITE.
- 3** Hold the **FADE** button down while recording until the picture fades out. Release to fade back in.

(no indication)	black
WHITE	(white)
◀ SFT	(soft)
◀ SHR	(sharp)
◀ MSC	(mosaic)
□ SFT	(soft)
□ SHR	(sharp)
□ STR	(stripe)
▤ RDM	(random)

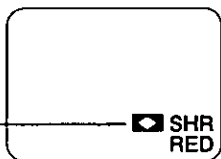

WHT	(white)
YEL	(yellow)
RED	(red)
MAG	(magenta)
BLU	(blue)
CYN	(cyan)
GRN	(green)
BLK	(black)

■ To create more effects: You can stop the fade at any time by pressing the **MODE SEL** button (other than BLACK, WHITE, and RANDOM modes). Pressing the **FADE** button will continue the fade.

Note:

- Other than BLACK and WHITE modes, the audio is not affected by the fade operation.

Color Digital Filter

This feature adds any of the six colors to the whole screen just like a color filter. The addition of color will give your recordings special nuance.

Before you begin...

- Connect the Camcorder to a power source.
- Set the POWER switch to CAMERA.
- Insert a cassette with record tab (see page 12).

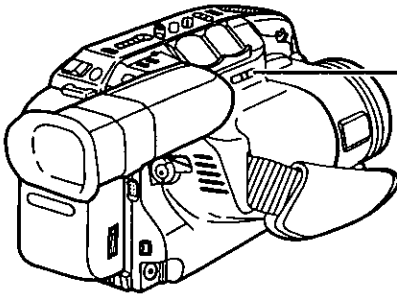

- 1** Hold down the D. FILTER, NEG/POS button for 2 seconds (approx.) to view or record a negative image.
 - The NEG. filter changes the picture from a positive to a negative image.

- 2** Press the D. FILTER, NEG/POS button repeatedly until the desired color filter appears.

- 3** Press the D. FILTER, NEG/POS button repeatedly until the normal image appears.

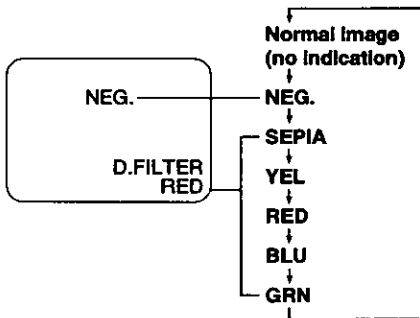

Note:

- During Digital Wipe or Digital Still/Strobe/Wide, the Color Digital Filter will not activate.
- Colored images will revert back to a normal image when viewed in still mode.

This feature allows you to increase the magnification of the Power Zoom.

Before you begin...

- Set the POWER switch to CAMERA.

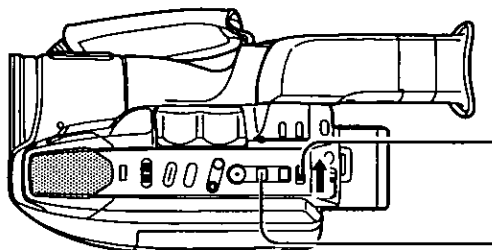
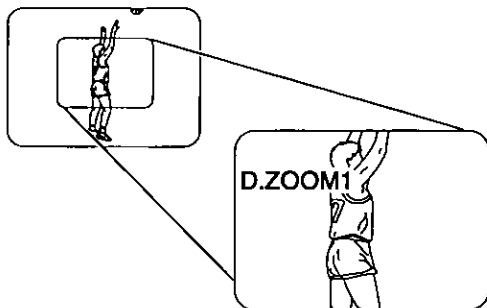

- 1** Slide the DIGITAL SELECT switch to D.ZOOM mode.

- 2** Press the DIGITAL ZOOM button once to select D.ZOOM 1 for partial increase (50x max.), or twice to select D.ZOOM 2 (300x max.) for an even greater increase.

Because the image is enlarged digitally, the picture may become distorted when higher magnification levels are used.

- 3** Press and hold the "T" side of the POWER ZOOM switch. Digital Zoom engages when the Optical Power Zoom reaches its maximum of 23x.

- Zoom level is displayed in the EVF.
- Press the "T" or "W" side of the POWER ZOOM switch to control the digital zoom level.
- When the level falls below 23x, the optical zooming function will resume.

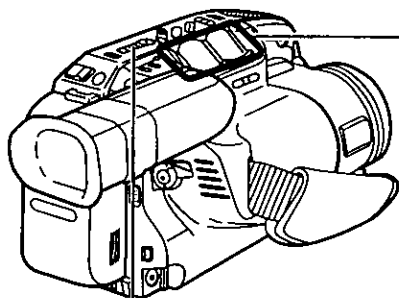

- 4** Press DIGITAL ZOOM until no indication appears in the EVF to turn the Digital Zoom feature off. (The zoom ratio will adjust to 23x.) (refer to page 33 for normal zoom operation.)

Digital E.I.S.

Digital Electronic Image Stabilization System

This feature helps stabilize the picture in situations such as walking or shooting from a moving vehicle.

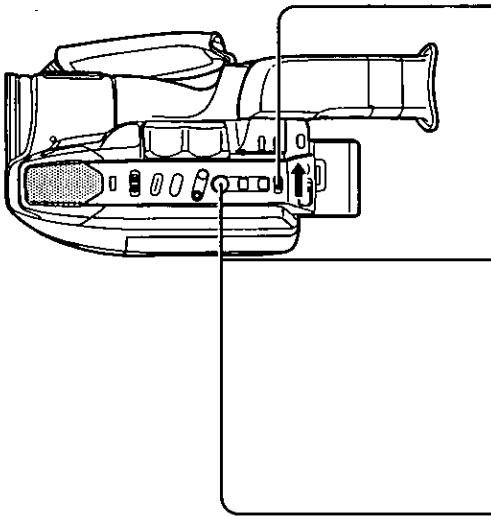

Before you begin...

- Set the POWER switch to CAMERA.

1 Slide the DIGITAL SELECT switch to EIS.

2 Press the EIS button to activate the Digital E.I.S. function. ("EIS" will appear in the EVF.)

- The image in the EVF will be enlarged slightly and the shutter speed will automatically adjust from 1/80 to 1/350 according to the brightness of the subject.

3 Press the EIS button again to cancel.

- You may also use the High Speed Shutter function (from 1/100 to 1/10000). The shutter speed you select remains active even after you cancel the Digital E.I.S. function.
- Be sure that the Digital E.I.S. is turned off when not in use.



NORMAL

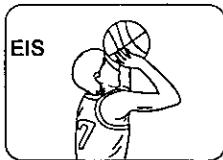

Digital EIS ON

Digital E.I.S. may not function when...

- Camcorder movement is too extreme.
- recording a subject with distinct horizontal or vertical stripes.
- recording in low light situations.
- EIS indicator flashes when the light level is inadequate.
- recording a subject under intense fluorescent light.
- recording a scene with very fast motions.

Slide the DIGITAL SELECT switch to STILL/STROBE.

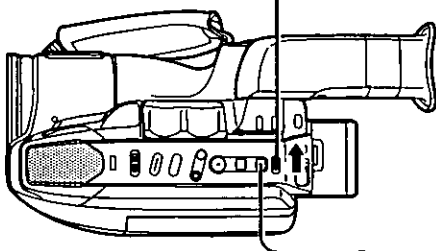

Still

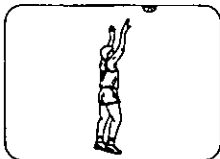

Strobe

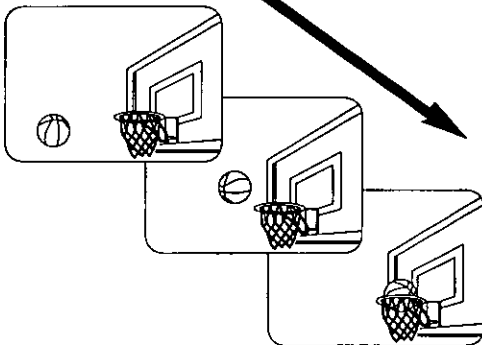

Wide Screen

EVF

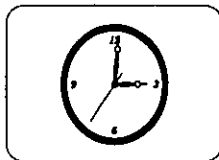
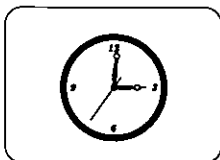

Normal

Wide

Before you begin...

- Set the POWER switch to CAMERA.

STILL/STROBE/WIDE Selection order

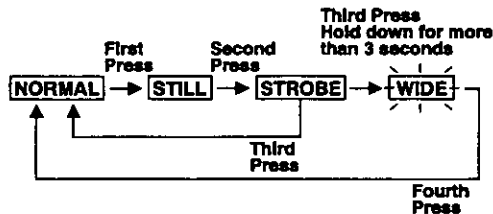

STILL

Use this feature to record a still image from the current camera picture.

Press the STILL/STROBE button once. Press two more times to return to normal recording.

STROBE

Use this feature to record a strobing progression of still images, (in 1/6 of a second intervals).

Press the STILL/STROBE button twice. Press once to return to normal recording.

WIDE SCREEN

Use this feature to fill the entire screen of your Wide Screen TV.

Hold down the STILL/STROBE button for more than 3 seconds while in Strobe mode (see above).

Press once again to return to a normal sized picture recording.

Note:

- Wide screen recordings must be played back using a wide screen (16x9 aspect ratio) TV or the picture will appear distorted.
- If you add titles (see pages 47-49) while recording in the Wide mode, they will appear distorted when played back on a wide screen (16x9 aspect ratio) TV.

Digital Wipe

This feature makes it possible to replace the current recorded scene with a memorized scene.

- 1** Slide the **DIGITAL SELECT** switch to **DIGITAL WIPE**.

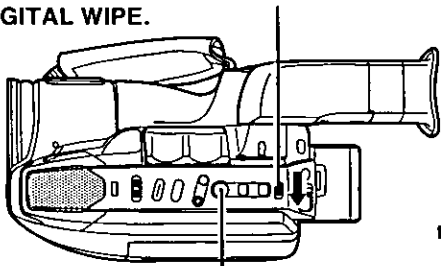

- 2** Press the **MEMORY** button while in the **Record/Pause** mode to memorize the desired scene.

- The picture fades out and then fades in. The memorized scene is displayed in the EVF for one second and "MEM." is displayed while the scene is memorized.
- The **MEMORY** button does not function when recording or when a scene from memory is being displayed.

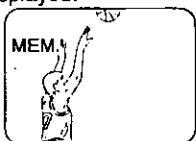

- 3** Press the **MODE** button repeatedly to select the desired Wipe effect.

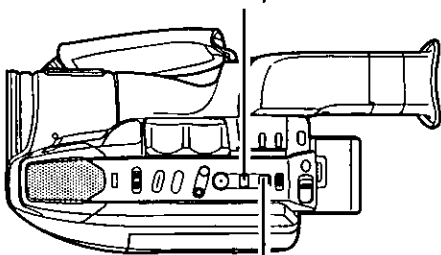

- 4** Press the **START** button to start the effect. The memorized scene gradually replaces the current recording. If **START** is pressed once more, the current recording will gradually replace the memorized scene.

- You can freeze the wipe in progress by pressing the **START** button. Press **START** again to continue the wipe.

Before you begin...

- Set the **POWER** switch to **CAMERA**.

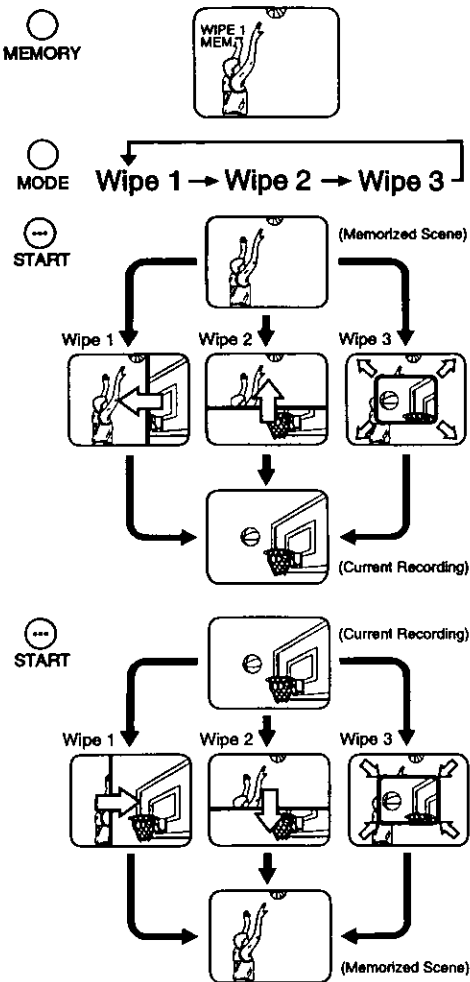

Note:

- The memorized scene will be cleared when the Camcorder is turned off.

Great for amateur surveillance applications. You can select Motion, Audio, or Motion•Audio Security mode.

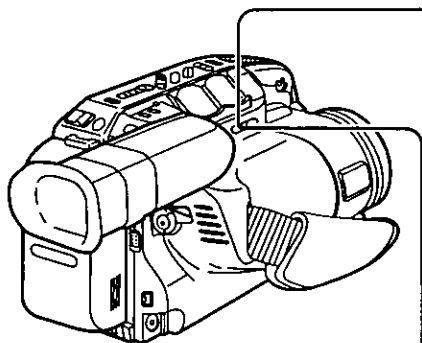

Motion Security recording may start, regardless of subject motion, when...

- the background is plain, such as a white wall.
- the Camcorder is pointed at something with distinct horizontal, vertical or oblique stripes, such as a window shade.
- the brightness suddenly changes.

Motion Security recording may not start when...

- motion is very slow or very fast.
- moving object is very small.
- motion is in 1 corner of the viewing area.
- in low light situations (MOTION SECURITY will flash if the light level is inadequate.)
- the background has distinct horizontal or vertical stripes.
- the background is plain, such as a white wall.

Audio Security recording may start when...

- The mic picks up wind noise (even a breeze).

Audio Security recording may not start when...

- The sound is too abrupt.

Before you begin...

- Connect the Camcorder to a power source. For extended Camcorder use, the AC Adaptor is recommended as the power source.
- Insert a cassette with record tab (see page 12).
- Set the POWER switch to CAMERA.
- Aim the Camcorder at the desired area.

1 In Record/Pause mode, hold down the **SECURITY MODE** button for about **2 seconds** to place the Camcorder in Motion Security stand-by mode.

2 Press the **SECURITY MODE** button **once** for Audio Security stand-by mode. **Or, press twice** for Motion•Audio Security stand-by mode. (If no cassette tape is inserted, "Ⓜ" will flash.)

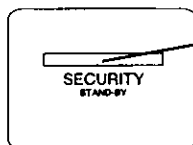

MOTION
↓
AUDIO
↓
MOTION•AUDIO

- The Camcorder will start recording approximately 3 seconds after motion and/or audio is detected.
- The date and time are also recorded if displayed (see page 16).
- Recording will stop 30 seconds after the motion and/or audio ceases.

3 Press the **SECURITY MODE** button **once, twice, or three times**, depending on the current mode, to cancel the Motion Security feature.

Note:

- Make sure the Camcorder is firmly secure before activating Motion Security feature. If the Camcorder is moved, Motion Security recording will start.
- While normal recording is being performed, the Camcorder cannot be placed in Motion, Audio, or Motion•Audio Security stand-by mode.
- While Camcorder is in Motion, Audio, or Motion•Audio Security stand-by mode, Record/Pause, Stand-by mode, Digital E.I.S., Color Digital Fade, One-Touch Auto Fade, Negative/Positive Transposer and Time Lapse mode can not be activated.

Audio Sensitivity

You can choose HIGH or LOW Audio sensitivity during Audio or Motion•Audio Security recording. The Camcorder is set to **LOW** at the factory.

Before you begin...

- Connect the Camcorder to a power source.
- Insert a cassette with record tab (see page 12).

During Audio Security or Motion•Audio Security stand-by mode (see page 43), press **UP ▲** or **DOWN ▼** to select **HIGH** or **LOW**.

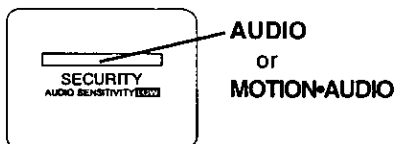
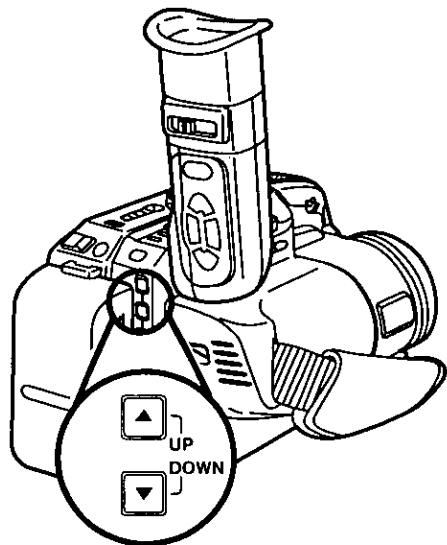

HIGH

Camcorder is sensitive to sound (normal conversation etc.) up to approx. 32.8 feet (10m).

LOW

Camcorder is sensitive to sound (normal conversation etc.) up to approx. 3.28 feet (1m).

- The Audio Sensitivity setting screen will revert to Audio or Motion•Audio Security stand-by mode after five seconds.
- The Audio Sensitivity setting will revert to **LOW** when Palmcorder is turned off.

Note:

- Because the Audio Security feature may be activated by surrounding natural noises, the Camcorder should be placed in as quiet a place as possible.
- When setting the Audio sensitivity level, the recording location should be taken into consideration.
- The performance level may vary depending on the spaciousness of the area used as well as differences in noise reflection and resonance.
- A test should be done to confirm that performance is satisfactory.

Time Lapse

You can use this feature for security purposes by recording over a long period of time (up to 6 hours with a T-40 tape).

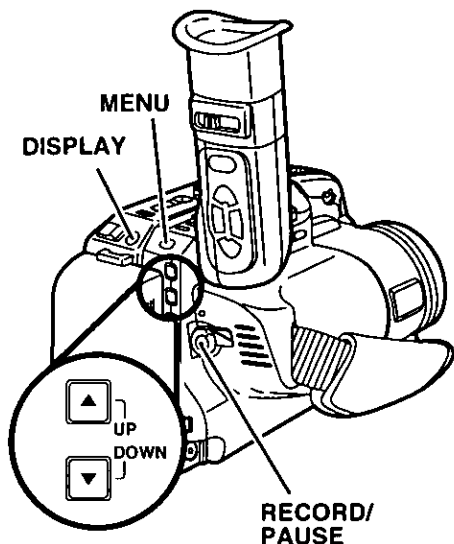

Note (in Time Lapse mode) :

- Sounds can not be recorded.
- Picture quality is lower than SLP mode.
- The tape is recorded at 1/3 the speed of SLP.
- The tape is played back at normal SLP speed (3 times faster than it was originally recorded).
- Video noise may occur during playback.
- SP/SLP indications will not be displayed.
- Titles will not be displayed.
- Interval REC cannot be activated.
- Vertical jitter may occur depending on monitor used.
- 10-Second Reminder (see page 19) will not display during Time Lapse recording.
- Vertical jitter may occur in color-EVF during playback.

CAUTION:

- Because recording system for the Time Lapse feature is not part of VHS standard, it is recommended to playback tapes recorded in Time Lapse mode on this Camcorder.
- Tapes not recorded in Time Lapse mode may be played back on other

VHS type camcorders or **VHS** type VCRs.

Before you begin...

- Connect the Camcorder to a power source.
For extended Camcorder use, the AC Adaptor is recommended as the power source.
- Insert a cassette with record tab (see page 12).
- Set the POWER switch to CAMERA.
- Slide the TAPE SPEED Selector to SLP.

1 Press the MENU button to display the MENU mode. Press UP ▲ or DOWN ▼ repeatedly to select **TIME LAPSE**.

- PROGRAMMED REC
- TITLE
- TALLY LAMP
- STAND-BY RELEASE
- CLOCK SET
- TIME LAPSE

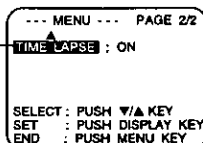

2 Press the DISPLAY button to set ON or OFF.

ON:

You can create an extended recording (up to 6 hours). This recording can then be played back at x3 speed.

OFF:

An extended recording (up to 6 hours) will not be possible.

3 Press the MENU button to set your selection and exit this screen.

4 Press RECORD/PAUSE button for recording START and STOP.

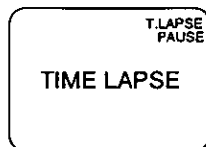

To cancel Time Lapse mode: Select **TIME LAPSE**; OFF from the menu screen.

Tally Lamp

You can choose to have the Tally lamp come on or stay off during recording. The default setting from the factory is ON mode.

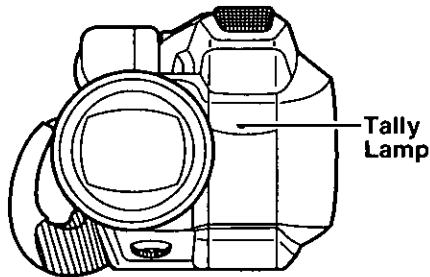

Before you begin...

- Connect the Camcorder to a power source.
- Set the POWER switch to CAMERA.
- Insert a cassette with record tab (see page 12).

1 Press the MENU button to display the MENU mode. Press UP ▲ or DOWN ▼ repeatedly to select **TALLY LAMP**.

```
--- MENU --- PAGE 1/2
PROGRAMMED REC
TITLE      : AUTOMANUAL
TALLY LAMP : ON
STAND-BY RELEASE : OFF
CLOCK SET
SELECT : PUSH ▼/▲ KEY
SET    : PUSH DISPLAY KEY
END    : PUSH MENU KEY
```

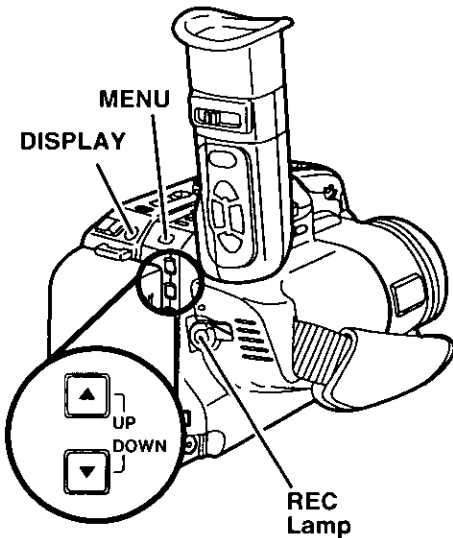

2 Press the DISPLAY button to set ON or OFF.

ON:

Tally Lamp comes on during recording.

OFF:

Tally Lamp and REC Lamp stay off during recording.

3 Press the MENU button to set your selection and exit the Menu mode.

Automatic Title

On selected holidays, such as New Year's Day, the Camcorder will automatically display the appropriate title when the power is first turned on.

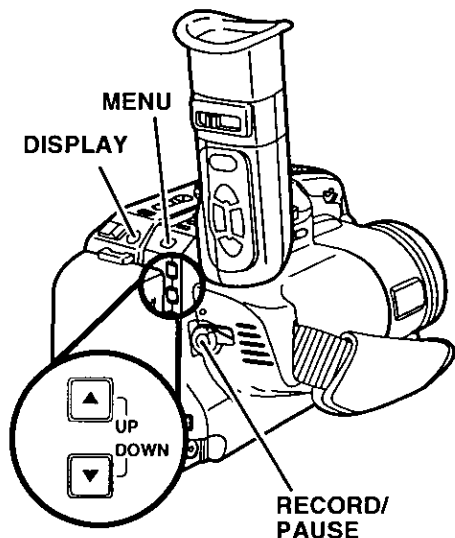

Before you begin...

- Connect the Camcorder to a power source.
- Set the POWER switch to CAMERA.
- Insert a cassette with record tab (see page 12).

1 Press the MENU button to display the MENU mode. Press UP ▲ or DOWN ▼ repeatedly to select **TITLE**.

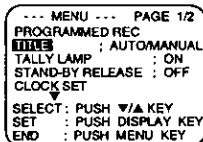

2 Press the DISPLAY button to select AUTO/MANUAL.

3 Press the MENU button to set your selection and exit the Menu mode.

4 To record the automatically displayed title, press the RECORD/ PAUSE button. (refer to page 48 for Automatic/ Manual Title Display List.)

5 To remove the title while recording, press the TITLE button.

Note:

- To remove the title before recording, press the TITLE button repeatedly until the On Screen Display disappears.
- You can display HAPPY ANNIVERSARY, HAPPY BIRTHDAY, VACATION, WEDDING DAY, or A SPECIAL DAY by pressing the TITLE button repeatedly in Pause (Record mode).
- The Camcorder will not automatically display a title once it has been removed. To redisplay the title, press TITLE in Pause (Record mode).

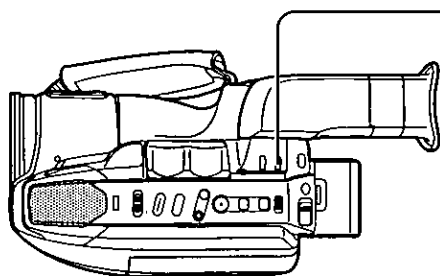

Intelligent Titler

Automatic/Manual Title Display List

Dec. 31–Jan. 1	HAPPY NEW YEAR! / CHEERS!
Feb. 14	VALENTINE'S DAY / BE MY VALENTINE
2nd Sunday in May	HAPPY MOTHER'S DAY / WE LOVE YOU!
Last Monday in May	MEMORIAL DAY
3rd Sunday in Jun.	HAPPY FATHER'S DAY / WE LOVE YOU!
Jul. 4	INDEPENDENCE DAY
1st Monday in Sep.	LABOR DAY
Oct. 31	HAPPY HALLOWEEN
4th Thursday in Nov.	HAPPY THANKSGIVING
Dec. 24–25	MERRY CHRISTMAS / HO! HO! HO!
These Titles must be displayed manually.	HAPPY EASTER HAPPY ANNIVERSARY HAPPY BIRTHDAY VACATION WEDDING DAY A SPECIAL DAY

Manual Title

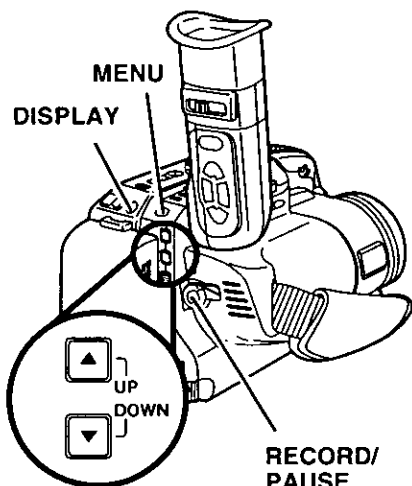

Before you begin...

- Connect the Camcorder to a power source.
- Set the POWER switch to CAMERA.
- Insert a cassette with record tab (see page 12).

- 1** Make sure that TITLE, in the Menu mode, is set to AUTO/MANUAL. (see steps 1~3 on page 47.)
- 2** In Pause (Record mode), press the **TITLE** button repeatedly to display the desired title from the list shown above.
- 3** Press the **RECORD/PAUSE** button to record the displayed title.
- 4** Press the **TITLE** button while recording to remove the title.

Note:

- To redisplay the title, press TITLE in Pause (Record mode).

Intelligent Titler

Phrase Title

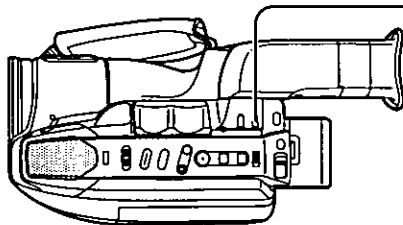
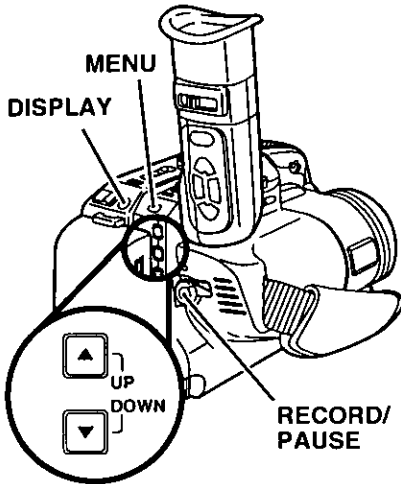

EVF Indications

(no indication)
↓
BEAUTIFUL
↓
BRAVO!
↓
CHEERS!
↓
CONGRATULATIONS
↓
GIMME A BREAK!
↓
GOOD LUCK
↓
I LOVE YOU
↓
OOPS!
↓
OUR LITTLE ANGEL
↓
WAY TO GO

Before you begin...

- Connect the Camcorder to a power source.
- Set the POWER switch to CAMERA.
- Insert a cassette with record tab (see page 12).

- 1** Press the MENU button to display the MENU mode. Press UP ▲ or DOWN ▼ repeatedly to select **TITLE**.

```
--- MENU --- PAGE 1/2
PROGRAMMED REC
TALLY LAMP : PHRASE : ON
STAND-BY RELEASE : OFF
CLOCK SET
SELECT : PUSH V/A KEY
SET : PUSH DISPLAY KEY
END : PUSH MENU KEY
```

- 2** Press the DISPLAY button to select PHRASE.
- 3** Press the MENU button to set your selection and exit the Menu mode.
- 4** In Pause (Record mode), press the **TITLE** button repeatedly to display the desired title from the list shown below.
- 5** Press the RECORD/PAUSE button to record the displayed title.
- 6** Press the **TITLE** button while recording to remove the title.

Note:

- To redisplay the title, press TITLE in Pause (Record mode).

Message Mode

You can leave audio/video messages for family or friends.

Before you begin...

- Connect the Camcorder to a power source. For extended Camcorder use, it is recommended to use the AC Adaptor as a power source.
- Insert a cassette with record tab (see page 12).
- Set the POWER switch to CAMERA.

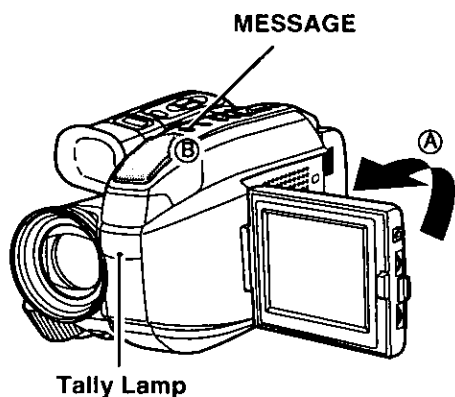

1 (A) Flip the LCD so that it faces toward the lens.

(B) Press the MESSAGE button to start recording your message.

- The LCD monitor must face forwards to activate Message mode.

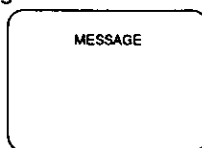

2 Press the MESSAGE button again to end message recording.

- The Camcorder automatically rewinds the tape to the message starting point, and then goes into Stand-by mode.
- The Tally Lamp flashes during Stand-by mode.



3 Press the PLAY button to playback the message.

- The LCD may be in any position for message playback.
- To cancel the MESSAGE mode: Set the POWER switch to OFF.

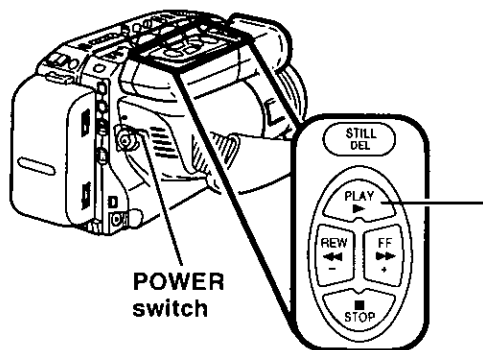

Note:

- Only one message can be recorded.
- If the tape is ejected or the battery (when used) becomes depleted while in Stand-by mode, the Message mode will be cancelled. To playback the message (tape is inserted and/or new power source is attached), Set the POWER switch to VCR and press the PLAY button.
- The MENU, TITLE and SECURITY MODE buttons are not activate during Message mode.
- Title display cannot be displayed during Message mode.
- The Message button is not <active> when in Time Lapse mode and Programmed Rec stand-by.

Copying your Tapes (dubbing)

Main Operation

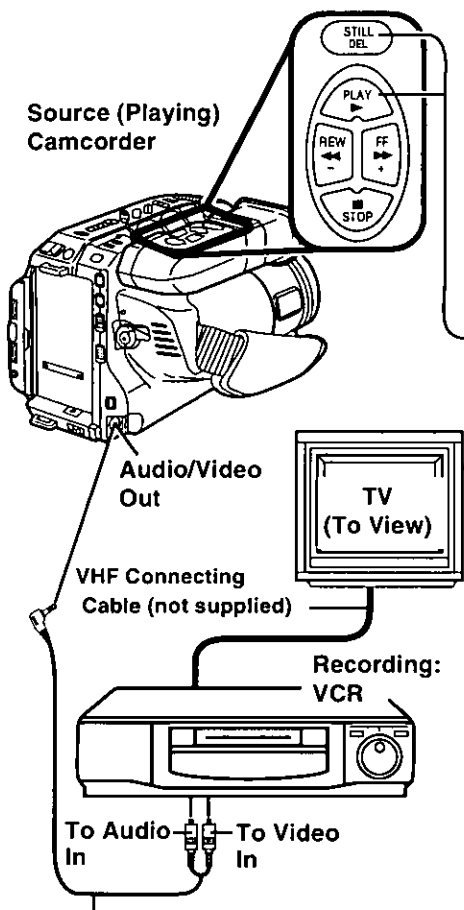

Audio/Video Cable (supplied)

Before you begin...

- Connect the Camcorder to VCR as shown at left.
- Turn ON both units.
- Set the recording VCR's Input Signal Selector to LINE.
- Set the Camcorder POWER switch to VCR.

- 1** Insert a pre-recorded tape into the Camcorder and a blank tape with a recording tab into your VCR.
- 2** Press **PLAY** on the Camcorder and when you find the starting point, press **STILL**.
- 3** Press **REC** on your VCR and then immediately press **STILL/PAUSE**.

VCR Buttons



- 4** Press **STILL** on the Camcorder and press **STILL/PAUSE** on the VCR to simultaneously start both units.
- 5** Press **STOP** on both units when dubbing is complete.

Note:

- Tapes recorded on other VCRs and used for playback in the Camcorder must be recorded in SP or SLP mode.
- For technical reasons, dubbing a tape may reduce its quality.

Monitor with your TV

- Turn the TV ON and select its VCR channel (CH3 or CH4).
- Set the VCR/TV Selector on the recording VCR to VCR.

CAUTION:

Unauthorized exchanging and/or copying of copyrighted recordings may be copyright infringement.

Using the Digital Still Camera

PHOTO REC Indications

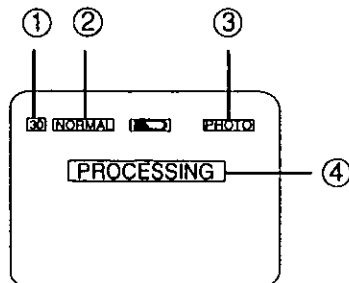

① Image Page Remaining Indication (see page 53)

- The number of the image pages left in the selected mode.
When no memory remains, "00" will flash.
- Approx 30 images can be stored in "NORMAL" mode, Approx 15 images can be stored in "FINE" mode.
(The number of pictures given for each mode applies when all the pictures are taken in the same mode.)

② REC MODE Indication

- The current REC MODE (NORMAL or FINE).
- Image Size is 640 X 480 pixels.

③ Recording Mode Indication

- The POWER switch is set to PHOTO.

④ Image Status Indication

When an image is captured, the image status is displayed.

PROCESSING:

Displayed while camera processes a captured image.

- Sliding the POWER switch to CAMERA while "PROCESSING" is displayed may cause the image to appear distorted.
Also, do not change the recording mode while "PROCESSING" is displayed.

COMPLETED:

Displayed after image has been completely processed.

- You can capture another image as soon as "COMPLETED" disappears.

PHOTO PLAY Indications

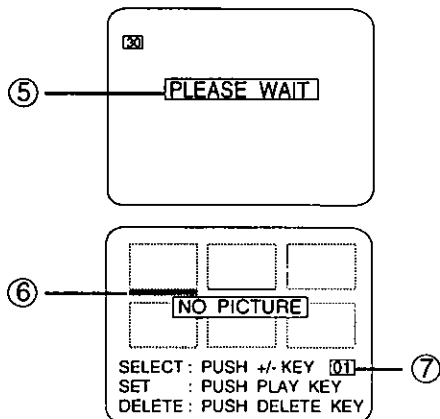

⑤ Image Status Indication (continued) PLEASE WAIT:

Displayed during image selection from the Multi Image Playback screen. Also displayed during image deletion.

- Sliding the POWER switch to CAMERA while "PLEASE WAIT" is displayed may cause the image to appear distorted.
Also, do not change the recording mode while "PLEASE WAIT" is displayed.

NO PICTURE:

Displayed when no image is captured, or when all the images are deleted from memory.

⑥ The currently selected image is underlined in red.

⑦ The current Multi Image Playback page number.

Using the Digital Still Camera

Recording

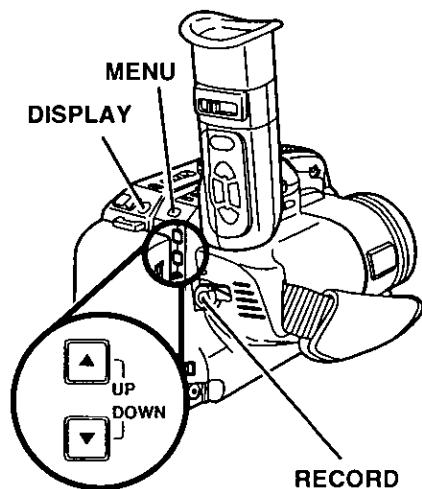
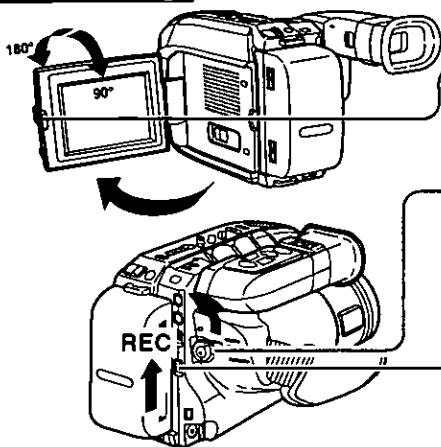

Before you begin...

- Connect the Camcorder to a power source.

1 Press the LCD-OPEN button to unlock the LCD monitor. Swing it fully open and adjust the angle.

2 Set the POWER switch to PHOTO. The built-in Lens Cover opens and POWER Lamp lights.

- Make sure the POWER switch is fully rotated to the PHOTO position.

3 Slide the PHOTO MODE Selector to REC.

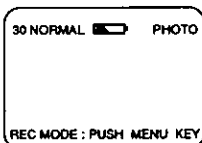

4 Press the MENU button to display the REC MODE screen. Press UP ▲ or DOWN ▼ to select the desired mode (refer to page 52) and then press the DISPLAY button to set.

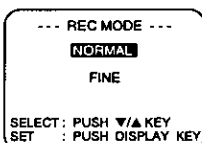

5 Press the RECORD button to capture the image.

- When you press the RECORD button, the two image status screens shown below will be displayed as the image is processed.

You may capture another image as soon as "COMPLETED" disappears.

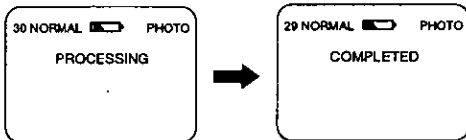

- Set the electronic shutter to a higher speed when shooting in bright surroundings such as outdoors. This helps eliminate blurring of the still image.

Note:

The following Features are not active during PHOTO mode.

- Fade
- Digital Zoom
- Still/Strobe / Wide
- Security Mode
- Time Lapse
- Message Mode
- Color Digital Filter
- Digital E.I.S.
- Digital Wipe
- Audio Sensitivity
- Intelligent Titrer

With this function, you can not record sound.

Using the Digital Still Camera

Playback

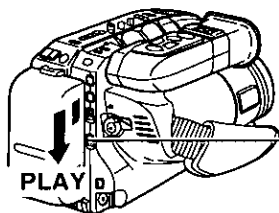
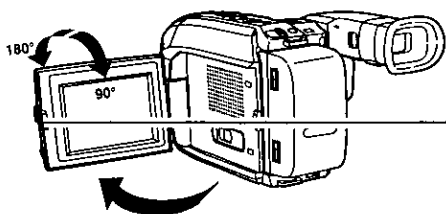

Before you begin...

- Connect the Camcorder to a power source.
- Set the POWER switch to PHOTO.

1 Press the LCD-OPEN button to unlock the LCD monitor. Swing it fully open and adjust the angle.

2 Slide the PHOTO MODE Selector to **PLAY**.

The first page of a Multi Image Playback screen appears. (Each page contains 6 images.)

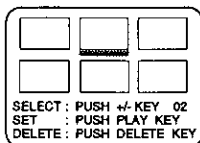

3 Press + (FF) for Next, or - (REW) for Previous until the image you want is underlined in red. (See below.)

- The image REC MODE (NORMAL or FINE) will not be displayed.

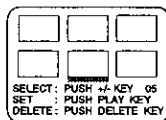
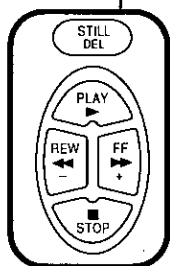

(+) KEY

(-) KEY

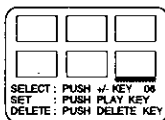

(+) KEY

(-) KEY

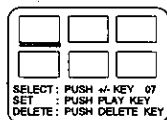

4 Press **PLAY** to display the selected image. This screen appears followed by the displayed image.

DISPLAY

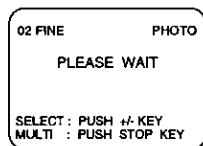
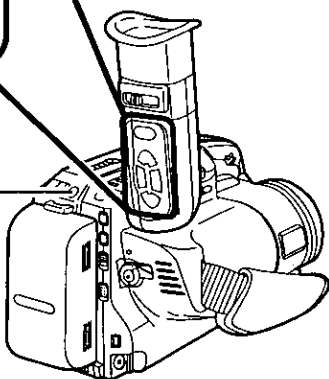

- Press the DISPLAY button, OSD will disappear. Press the DISPLAY button again, OSD will appear.
- Pressing + (FF) will display the image on the next page. Pressing - (REW) will display the image on the previous page.
- Press STOP to return to the Multi Image playback screen.

Using the Digital Still Camera

To delete specific image pages

You can delete unwanted images and increase the remaining image memory.

Warning : Once deleted, images cannot be restored.

Before you begin...

- Connect the Camcorder to a power source.
- Set the POWER switch to PHOTO and slide the PHOTO MODE selector to PLAY.

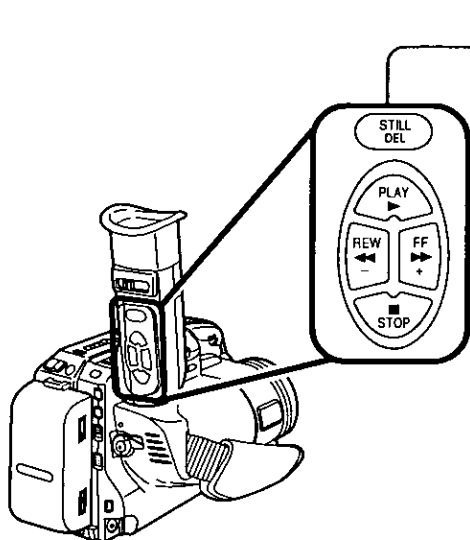

1 Press DEL(STILL) to display the DELETE menu.

- To exit this menu, press STOP.

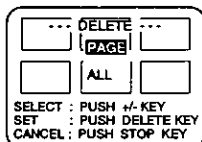

2 Press + (FF) or - (REW) to select PAGE, and then press DEL(STILL) to continue.

- To exit this menu, press STOP.

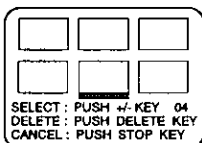

3 Press + (FF) or - (REW) to select the image page to be deleted.

- To exit this menu, press STOP.

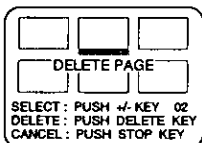

4 Press DEL(STILL) to delete the selected image page.

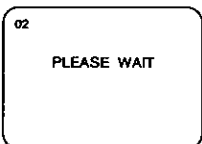

- "PLEASE WAIT" is displayed on-screen while the image page is deleted.
- Image page numbers are adjusted automatically as image pages are deleted.
- To delete other specific image pages, repeat steps 1 - 4.

Using the Digital Still Camera

To delete all image pages

You can delete all images from memory with one easy operation.

Warning : Once deleted, images cannot be restored.

Before you begin...

- Connect the Camcorder to a power source.
- Set the POWER switch to PHOTO and slide the PHOTO MODE selector to PLAY.

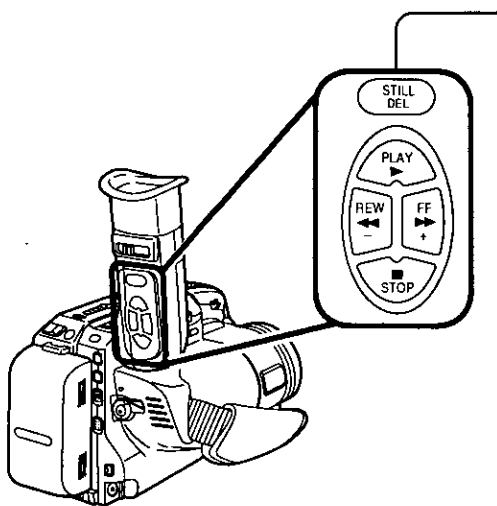

1 Press DEL(STILL) to display the DELETE menu and select **ALL**.

- To exit this menu, press STOP.

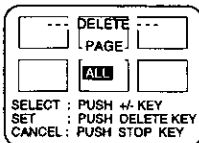

2 Press DEL(STILL). The following message will appear.

- To exit this menu, press STOP.

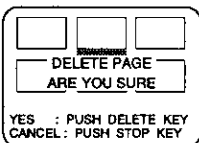

3 Press DEL(STILL) to delete all image pages from memory.

- "PLEASE WAIT" is displayed on-screen while all image pages are deleted.



- After deletion is completed, "NO PICTURE" will be displayed.

Note:

While "PLEASE WAIT" is displayed, do not turn off the Camcorder or unplug the AC Adapter.

Otherwise, the Camcorder will not work for about 30 seconds when turned back on or when the AC Adapter is plugged back in because the image deletion must be performed.

When it becomes impossible to record, playback, or delete image pages while in PHOTO mode, please delete all memorized image pages by doing the following.

While holding down NEG/POS, STILL and BACKLIGHT at the same time, slide the POWER switch from OFF to PHOTO.

All image page deletion will be completed in about 30 seconds. Slide the POWER switch to OFF, and then to PHOTO. You can now record, playback, or delete image pages normally.

Using the Digital Still Camera

Using the image as a Wipe

You can use the still image, captured in PHOTO Mode, as a WIPE screen for title memory. (See page 53.)

Before you begin...

- Connect the Camcorder to a power source.
- Set the POWER switch to PHOTO and slide the PHOTO MODE selector to PLAY.

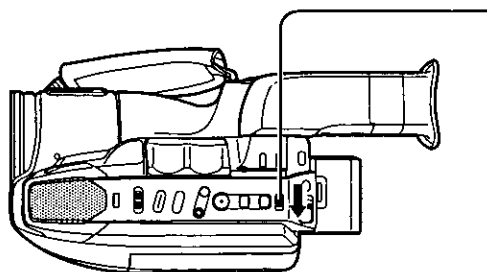

- 1** Set the DIGITAL SELECT Switch to DIGITAL WIPE. (Refer to page 42.)

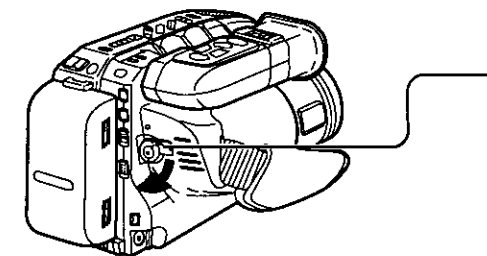

- 2** Select the image from the Multi Image screen that you want to use as a WIPE image.

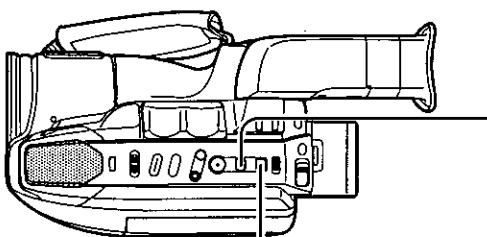
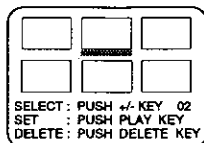

- 3** Slide the POWER switch to CAMERA.
- The memorized scene is displayed in the EVF for one second and "MEM." is displayed while the scene is memorized.

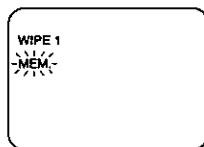

- 4** Select the WIPE MODE button (see page 42), and then press the START button to start the WIPE effect. The memorized image gradually replaces the current recording.

WIPE START

Note :

The selected scene will be cleared when the Camcorder is turned off.

PC Connection

Digital PhotoShot Software

A live image or stored still image in the Camcorder's memory can be transferred directly to your PC (Personal Computer). Likewise, the PC's memory can be transferred directly to Camcorder via an RS-232C connection.

You can also download title images from Panasonic's web site on the Internet (www.panasonic.com/photoshot).

System Requirements:

- IBM PC/AT or compatible.
- Windows 95.
- 486 CPU or higher. (Pentium® recommended.)
- RAM: 8MB
- 2MB minimum available hard disk space.
- 256 color monitor (full color recommended).
- 3.5 inch 1.44MB floppy disk drive (for installation).
- RS-232C serial port (D-Sub 9-pin). An adaptor (D-Sub 9-pin male to a D-Sub female) is required for a D-Sub 25-pin.
- Mouse or other pointing device.
- Microsoft, Windows, and Windows 95 are registered trademarks of Microsoft in the United States and other countries.
- All product/brand names are trademarks or registered trademarks of the respective holders.

PC-Camcorder Connection

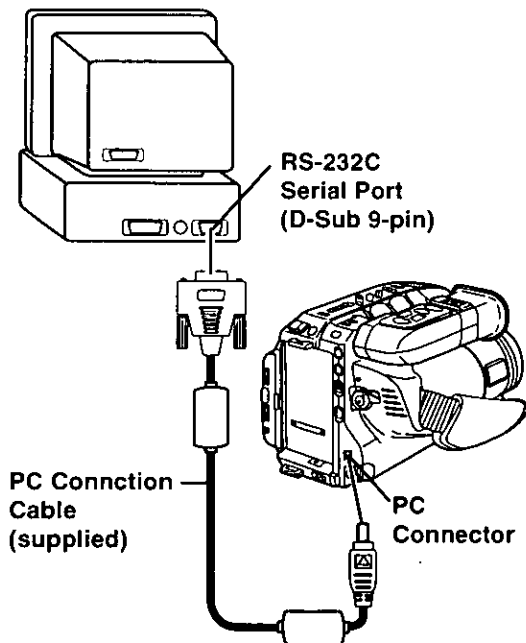

Connect the supplied PC connecting cable to the PC connection jack on the Camcorder and a serial port on the PC (Personal Computer).

(Please refer to the PC's instruction book to clarify what port should be used to connect.)

Note:

- Before connecting the Camcorder to the PC, make sure the PC power is off to insure that images are transferred properly.
- While the Camcorder is connected to a PC and the software is opened, you tape recording is not possible.

Software Installation (Windows 95)

- 1 Turn on the PC (Personal Computer) and start up Windows.
- 2 Insert the Digital PhotoShot disk (Windows 95) into a floppy disk drive.
- 3 Select **"Run..."** from the Windows 95 start menu.

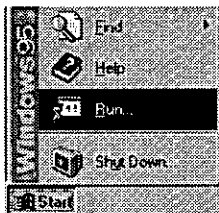

- 4 Type in **A:\setup.exe** and click OK.
 - It is assumed that your 3.5 inch floppy disk drive is assigned as "A" drive. If not, replace "A" with the appropriate letter.

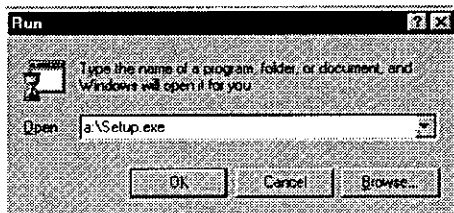

- 5 Follow the instructions as they appear on your PC screen.
- 6 When the installation has been completed, **"Setup has finished installing the application on your computer. You may launch the application by selecting the icons installed."** appears. Click the **Finish** button to complete Setup.

Running the Software (Windows 95)

- 7 From the Windows 95 Start Menu, select Programs/Digital PhotoShot.



- 8 Please read the Help information to operate the application.

PC Connection

Plug-in Driver for Adobe® PhotoDeluxe™ 2.0 Installation

The Plug-in Driver, when installed, allows your camera to communicate directly with PhotoDeluxe 2.0.

Note:

Please install Adobe PhotoDeluxe 2.0 before proceeding with the steps below.

1 Turn on the PC (Personal Computer) and start up Windows.

2 Insert this disk into Drive A.

3 Click the "Start" button, go to "Programs", and then click "Explorer".

4 Copy the "\Plug-in\Palmcorder.8ba" file to the "\PhotoDeluxe 2.0\Plug-ins" folder.

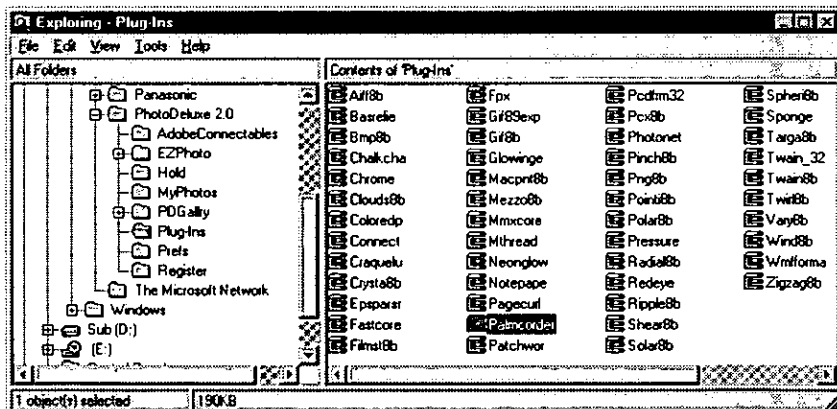
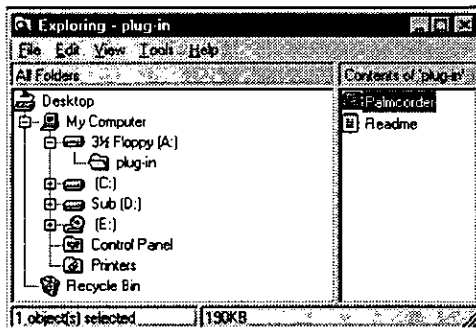
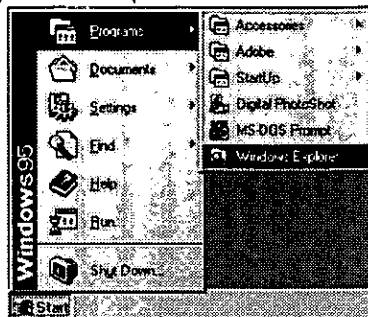







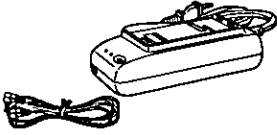

5 When installation is completed, start up PhotoDeluxe 2.0 and follow the instructions on how to transmit images.

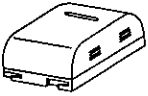
Adobe and PhotoDeluxe are trademarks of Adobe Systems Incorporated.

Palmcorder Accessory System

For ordering instructions, see the Accessory Order Form page.

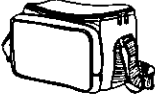
Accessory #	Figure	Description	Price
PV-A17		AC Adaptor with DC Power Cable	\$130.00
P-V215		3.0Ah Battery Pack	\$60.00
PV-BP17/ P-V214		2.4Ah Battery Pack	\$50.00
PV-BP18/ P-V611		1.8Ah Battery Pack	\$45.00
PV-BP15/ P-V213		1.2Ah Battery Pack	\$45.00
PV-AA6		"AA" Battery Case	\$20.00
PV-C16		Car Battery Cord	\$70.00
PV-RF16		RF Adaptor	\$40.00
PV-P1		VHS PlayPak	\$35.00
PV-H18		Soft Sided Carrying Case	\$49.00

For Your Information

Palmcorder Accessory Order Form

Please photocopy this form when placing an order.

1. Palmcorder Model # _____

2. Items Ordered

Accessory #	Description	Price Each	Quantity	Total Price
Subtotal				
Your State & Local Sales Tax				
Shipping & Handling				5.00
Total Enclosed				

3. Method of payment (check one)

- Check or Money Order enclosed (NO C.O.D.SHIPMENTS)
- VISA Credit Card # _____
- MasterCard Expiration Date _____
- Discover Customer Signature _____

Make Check or Money Order to: MATSUSHITA ACCESSORIES

(Please do not send cash)

4. Shipping information (UPS delivery requires complete street address)

Ship To:

Mr.

Mrs.

Ms.

First _____ Last _____

Phone #: .

Day () _____

Street Address _____

Night () _____

City _____ State _____ Zip _____

TO OBTAIN ANY OF OUR OMNIMOVIE/PALMCORDER ACCESSORIES YOU CAN DO ANY OF THE FOLLOWING:

VISIT YOUR LOCAL PANASONIC DEALER

OR

CALL PANASONIC'S ACCESSORY ORDER LINE AT 1-800-211-7262
[9 AM-9 PM M-F, 9 AM-7 AM SAT-SUN, EST]

OR

MAIL THIS ORDER TO: PANASONIC SERVICES COMPANY ACCESSORY
ORDER OFFICE

20421 84th Avenue South Kent, WA. 98032

Notes Regarding Operations

Attaching Optical Filters and Lenses

Be careful not to touch the lens itself when attaching optical filters and lenses.

Cleaning the EVF (Electronic Viewfinder)

To Remove

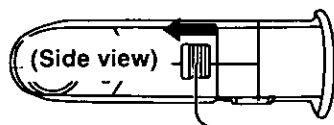

1 Slide and hold the EYEPIECE RELEASE button.

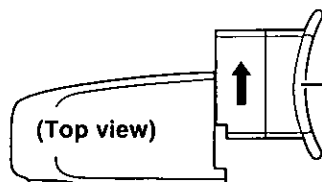

2 Slide the eyepiece in the direction of the arrow. (DO NOT TWIST)

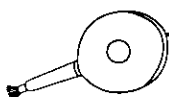
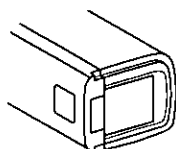

3 Remove any lint or dust particles with a blower, available at photography stores. Do not touch lenses with fingers. Then, replace the eyepiece.

Specifications

Power Source:	Compact VHS Camcorder: DC 6V AC Adaptor: 110/120/220/240V AC, 50/60 Hz Battery: Nickel-Cadmium Type DC 6V
Power Consumption:	Compact VHS Camcorder: 6V DC 8.5 W (Max. 11.5 W) AC Adaptor: 24W 1.2W (when not in use.)
Video Signal:	EIA Standard (525 lines, 60 fields) NTSC color signal
Video Recording System:	4 rotary heads plus flying erase head. Helical scanning system
Audio:	1 track
Pick-Up System:	Sequential color difference field reverse system
Pick-Up Device:	One integral color filter Charge Coupled Device (CCD)
Lens:	23:1 zoom lens, F1:1.6 with auto iris control Focal length: 3.8mm - 87.4mm Power zoom function Lens filter diameter: 52mm
Viewfinder:	0.5 inch (12.7mm) Liquid Crystal color Electronic Viewfinder
LCD Monitor:	3.2 inch (81.2mm) Liquid Crystal Display
Memory:	Built-in 1MB Memory
Image Size:	640 × 480 pixels
Image Storage:	FINE: Approx. 15 images Normal: Approx. 30 images
Image Format:	JPEG
Minimum Illumination Required:	1.2 lx (F1:1.6) 0.12 footcandles 7 lx (F1:1.6) 0.7 footcandles (EIA Standard)
Earphone Jack:	M3 Type
External Microphone Jack:	M3 Type
Operating Temperature:	32°F-104°F (0°C-40°C)
Operating Humidity:	10%-75%
Weight:	Compact VHS Camcorder: 2.4 lbs. 1.10 kg AC Adaptor: 0.77 lbs. 0.35 kg
Dimensions:	Compact VHS Camcorder: 4-3/8 (W) × 4-5/8 (H) × 7 (D) inch 110 (W) × 116 (H) × 177 (D) mm AC Adaptor: 2-3/4 (W) × 1-5/8 (H) × 5-3/4 (D) inch 70 (W) × 41 (H) × 145 (D) mm

Weight and dimensions shown are approximate.

Designs and specifications are subject to change without notice.

Before Requesting Service

If you have a problem with your Camcorder, it may be something you can correct yourself. Check the list below for symptoms and corrections.

Symptom	Correction
No picture in the EVF ...	<ul style="list-style-type: none"> • Make sure a Power Source is connected. (pp. 9, 11) • Make sure the POWER switch is set to VCR or CAMERA. (pp. 23, 29) • Check the Dew Indicator. (p. 20) • Make sure the battery is fully charged. (p. 9) • Make sure all necessary cables are connected correctly and firmly. (p. 31)
Video cassette cannot be inserted ...	<ul style="list-style-type: none"> • Make sure a Power Source is connected. (pp. 9, 11) • Insert the cassette with the window side facing out. (p. 12)
Video cassette cannot be removed ...	<ul style="list-style-type: none"> • Make sure a Power Source is connected. (pp. 9, 11)
No operation starts when operation buttons are pressed ...	<ul style="list-style-type: none"> • Check for the Dew Indicator. (p. 20)
Recording cannot be done ...	<ul style="list-style-type: none"> • Make sure the record tab is still intact. (p. 12) • Check the Battery Indicator. (p. 18) • Check the Dew Indicator. (p. 20)
Auto Focus does not operate ...	<ul style="list-style-type: none"> • Make sure the FOCUS button is set to AUTO. (p. 34) • Make sure the unit is ON, with the POWER switch set to CAMERA (p. 23).
The Message mode cannot be used ...	<ul style="list-style-type: none"> • Make sure a cassette is inserted and that the LCD monitor is facing the same direction as the lens (p. 50).
Sound from microphone can't be monitored ...	<ul style="list-style-type: none"> • Make sure the unit is set to REC or Record/Pause mode.
Camera picture is too dark ...	<ul style="list-style-type: none"> • Make sure the HIGH SPEED SHUTTER button is OFF (p. 35).
No playback picture, or the playback picture is noisy or contains streaks ...	<ul style="list-style-type: none"> • Press UP ▲/DOWN ▼ button during playback (Tracking Control) (p. 30).
During playback, the picture shows motion or blurred action ...	<ul style="list-style-type: none"> • Portions of the still picture where the normal speed motion was particularly rapid may produce this effect. This is normal.
The playback picture is fast and there is no sound ...	<ul style="list-style-type: none"> • Make sure the TIME LAPSE feature is set to OFF in the Menu mode (p. 45).
"Panasonic IT'S VHS! SO ITS TAPES PLAY IN YOUR VCR ..." appears in the EVF and Monitor ...	<ul style="list-style-type: none"> • Set the POWER switch to CAMERA, and then hold down STOP for 5 seconds (approx.) to exit the Demo mode (p. 7).
If the top of your playback picture waves back and forth excessively ...	<ul style="list-style-type: none"> • Because the playback signal is not as stable as an off the air TV signal, the top of your TV screen may be bent or unstable when the tape is played back. This symptom is more noticeable when a tape recorded on another VCR is played back. To solve this problem, locate the horizontal hold control on your TV. Turn it slowly to correct the wavy picture. If your TV does not have a horizontal hold control or adjusting the control does not help, some modifications may have to be made to the TV set. Technically this is called "Horizontal AFC time constant change." If such a problem exists, please contact your local TV service center. (Some nominal service charges may be required.)

Before Requesting Service

Cleaning Care for Video Heads



Clogged Video Head

(a) **Video Head Cleaning:** Your Camcorder will not normally require head cleaning; however, it is possible that the heads may become clogged when playing an old or damaged tape. If the image on your screen resembles the photograph on the left while playing back a tape, the heads may require cleaning.

(b) **Cleaning the Heads:** It is recommended that head cleaning be performed by a qualified service technician. Please contact your nearest Panasonic Service Center. An alternate solution is to obtain a head cleaning cassette. There are many types of cleaning cassettes, so be sure to follow the cleaning instructions carefully. Excessive use of the cleaning cassette could shorten head life. Use this cassette only when a head clogging symptom occurs.

Refer servicing to qualified service personnel.

Request for Service Notice

Please photocopy this form when making a request for service notice.

Request for Service Notice:

In the unlikely event this product needs service.

- Please include your **proof of purchase**.
(Failure to do so will delay your repair.)
- To further speed your repair please provide an explanation of what is wrong with the unit and any symptom it is exhibiting.

Mail this completed form and your Proof of Purchase along with your unit to:

Panasonic Services Company
1705 N. Randall Road
Elgin, IL. 60123-7847
Attn: Camcorder Repair

Index of Controls

Front View

Built-In Twin Capsule 2-Way Microphone System
See page 22.

Built-in Auto Light
See page 22.

Remote Sensor
See page 28.

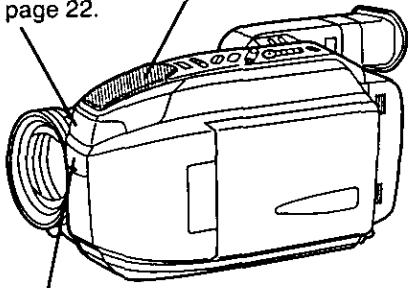

Built-In Lens Cover
Opens automatically when the Power Switch is set to CAMERA.
See pages 8, 23, 53.

Tally Lamp
See pages 23, 46, 50.

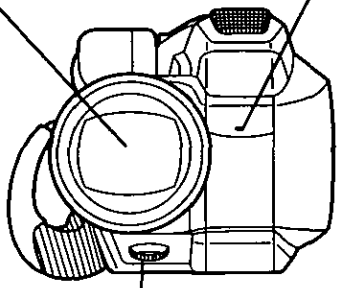

MANUAL FOCUS Wheel
See page 34.

Rear View

External MIC IN
Connect the external Microphone (using an M3 connector if necessary).
The built-in microphone is automatically disconnected when an external microphone is plugged in.



External Microphone (not supplied)

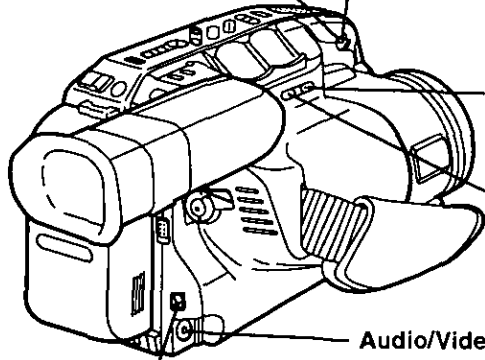

D.FILTER NEG/POS Button
See page 38.

SECURITY MODE Button
See page 43.

Audio/Video Output Connector
See pages 31, 51.
(This connector for use with supplied Audio/Video cable only.)

PC Connector
See pages 58.

For Your Information

Index of Controls

Rear View

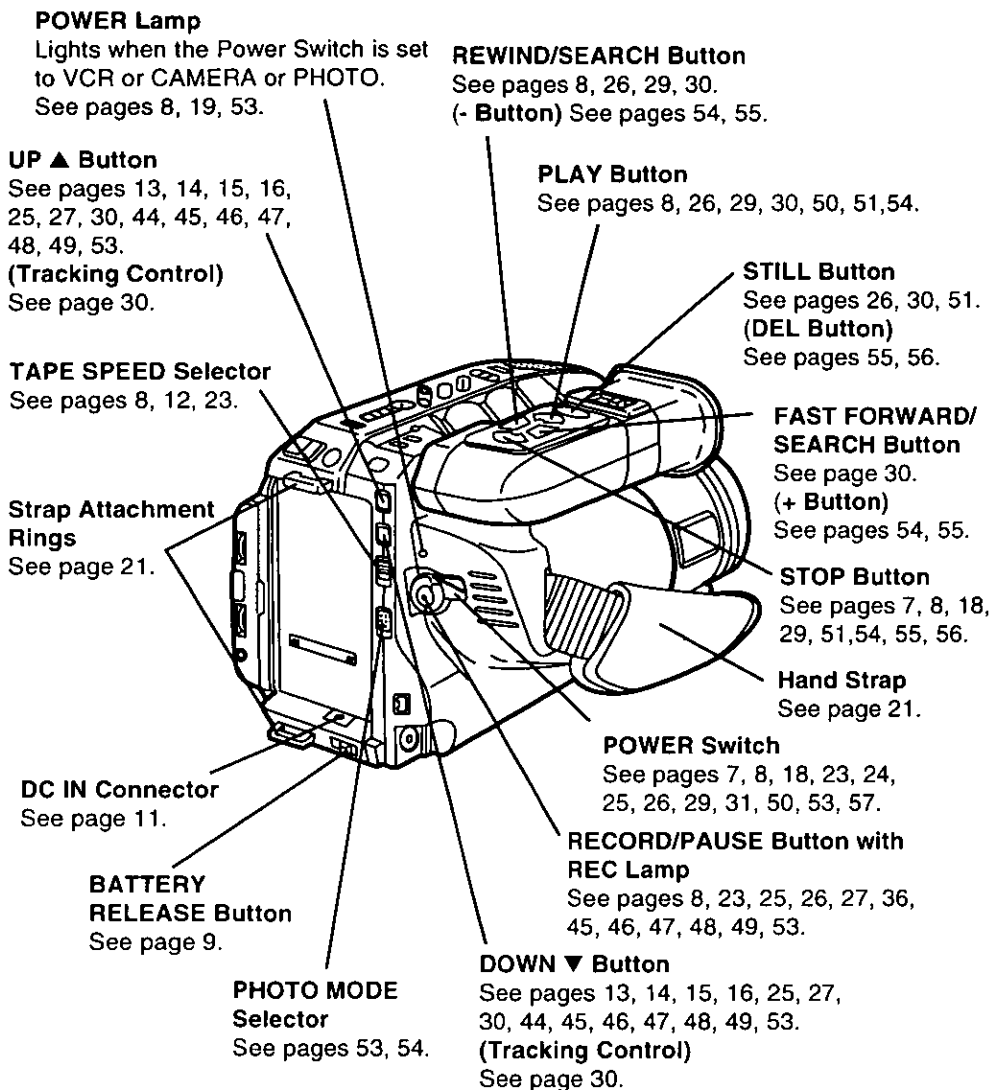

Index of Controls

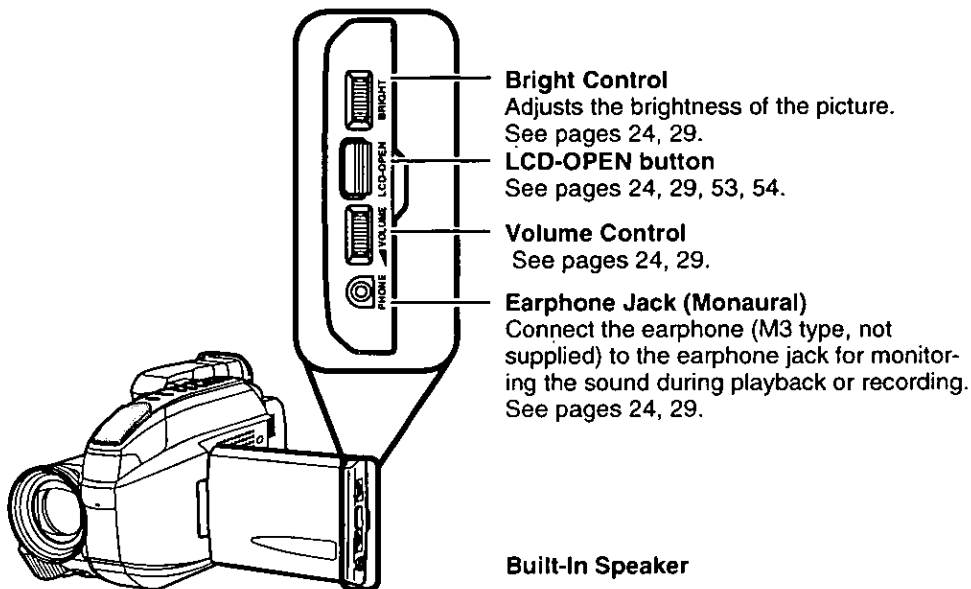

LCD (Liquid Crystal Display) Monitor
See pages 24, 29.

Built-In Speaker

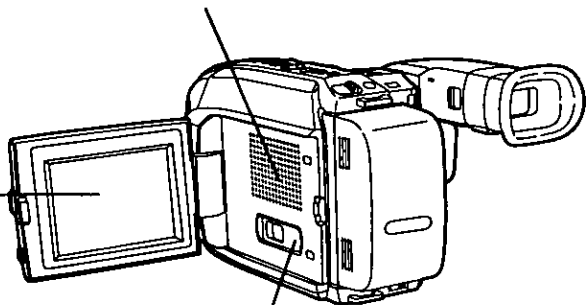

PUSH TO CLOSE Area

Underside View

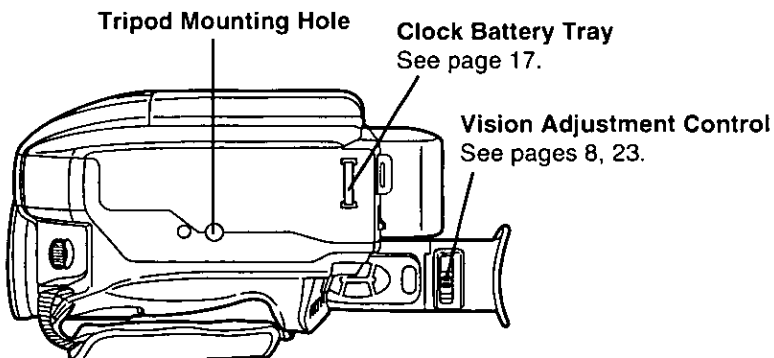

Index of Controls

Top View

HIGH SPEED SHUTTER Button
See page 35.

MODE SEL Button
See pages 36, 37.

TITLE Button
See pages 47, 48, 49.

POWER ZOOM Switch
See pages 33, 34.

MENU Button
See pages 13, 14, 15, 16, 25,
27, 45, 46, 47, 48, 49, 53.

MESSAGE Button
See page 50.

Electronic Viewfinder (EVF)
See pages 18, 19, 20, 63.

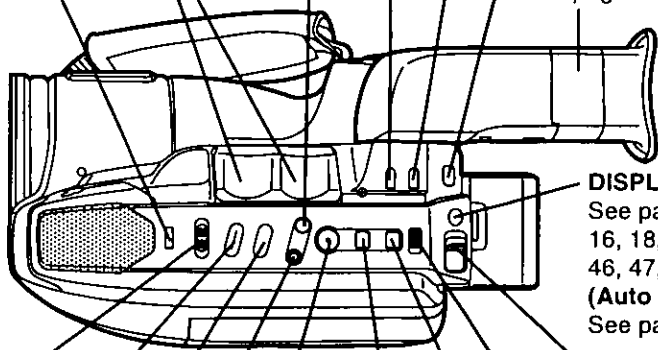

DISPLAY Button
See pages 13, 14, 15,
16, 18, 25, 27, 30, 45,
46, 47, 48, 49, 53, 54.
(Auto Tracking)
See page 30.

LIGHT Switch
See page 22.

TAPE EJECT Switch
See pages 8, 12, 23.

BACKLIGHT Button
See page 33.

DIGITAL SELECT Switch
See pages 39, 40, 41, 42, 57.

FADE Button
See pages 36, 37.

STILL/STROBE Button
See page 41.

COLOR Button
See page 37.

EIS Button
See page 40.
**DIGITAL WIPE
MEMORY Button**
See page 42.

**DIGITAL WIPE START
Button**
See pages 42, 57.

DIGITAL ZOOM Button
See page 39.

DIGITAL WIPE MODE Button
See pages 42, 57.

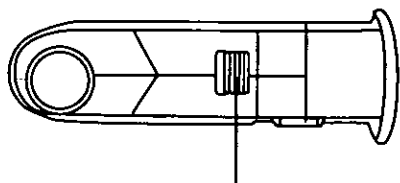

EYEPIECE RELEASE button
See page 63.

Index of Controls

8-Function Remote

POWER ZOOM Button
See page 28.

REWIND/SEARCH Button
See page 28.

PLAY Button
See page 28.

STOP Button
See page 28.

RECORD/PAUSE Button
See page 28.

FAST FORWARD/SEARCH Button
See page 28.

STILL Button
See page 28.

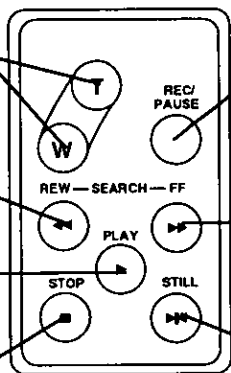

AC Adaptor

POWER Lamp
See pages 9, 11.

CHARGE Lamp
See pages 9, 10.

AC Power Cord
See pages 9, 10, 11.

VCR DC OUT Connector
See page 11.

Battery Charging Compartment
See page 9.

BATTERY REFRESH Button
See page 10.

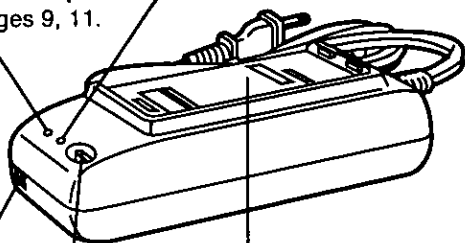

CAUTION:

This unit will operate on 110/120/220/240V AC. An AC plug adaptor may be required for voltages other than 120V AC. Please contact either a local or foreign electrical parts distributor for assistance in selecting an alternate AC plug. We recommend using the accessory power plug adaptor (VJSS0070) in an area which has special AC outlets.

Index

- A**
AC Adaptor 2, 11, 61
Accessories (Optional) 61
Accessories (Supplied) 2
Audio Sensitivity 44
Audio/Video Cable 2, 31, 51
Auto Daylight Saving Time 15
Auto Focus 34
- B**
Backlight 33
Battery Pack 2, 9, 10, 61
Battery Remaining Indication 18, 19
Battery Warning 19
- C**
Camera Recording 23, 24, 25, 26, 27
Car Battery Cord 11, 61
CH 3/4 Switch 31
Charging Battery 9
Cleaning Care for Video Heads 66
Clock Battery 2, 17
Clock Set 14, 15, 16, 17
Color Digital Fade 37
Color Digital Filter 38
Copying your Tapes 51
- D**
DC Power Cable 2, 11, 61
DEW Indication 20
Digital E.I.S. 40
Digital Still Camera 52, 53, 54, 55, 56, 57
Digital Wipe 42
Digital Zoom 39
Display-off Mode 18
- E**
Easy Edit Stand-by 26
Erase Protection Tab 12
EVF/LCD Monitor Indications 18, 19, 20
External Microphone jack 67
- F**
Fade 36, 37
- H**
High Speed Shutter 35
High Speed Shutter Indicator 20, 35
- L**
Light 22
- M**
Macro Focus 34
Manual Focus 34
MENU Mode 13
Message Mode 50
- O**
One-Touch Auto Fade 36
- P**
PC Connection 58, 59, 60
PHONE (earphone) jack 24, 29
PLAY Indicator 19
Playback 29, 30, 31, 32
PlayPak 2, 32, 61
Power Supply 9, 10, 11
Programmed Recording 27
- R**
REC Indicator 19
Remote Control 2, 28, 71
Remote Control Holder 2, 21, 28
Request for Service Notice 66
RF Adaptor 31, 61
- S**
Safety Precautions 3
Search Speed 30
Security Mode 43
Self Demo Mode 7
Shoulder Strap 2, 21
Special Effects Playback 30
Specifications 64
Stand-by Quick Release 25
Still / Strobe / Wide 41
Still Picture 30
Symptom/Correction 65
- T**
10-Second Reminder 19
Tab 12
Tally Lamp 46
Tape Speed 12
Tape Warning 19
Time Lapse 45
Titler 47, 48, 49
Tracking Control 30
- V**
VCR-MODE Indication 20
VHF Connecting Cable 31, 51
Video Cassettes (tapes) 12
Viewing 31
- W**
Warranty 73, 74
- Z**
Zoom In/Out 33

Panasonic Consumer Electronics Company, Division of Matsushita Electric Corporation of America
 One Panasonic Way Secaucus,
 New Jersey 07094

Panasonic Sales Company, Division of Matsushita Electric of Puerto Rico, Inc.
 Ave. 65 de Infanteria. Km. 9.5
 San Gabriel Industrial Park, Carolina, Puerto Rico 00985

PANASONIC/QUASAR Video Products Limited Warranty

Panasonic Consumer Electronics Company or Panasonic Sales Company (collectively referred to as "the Warrantor") will repair this product with new or refurbished parts, free of charge, in the USA or Puerto Rico, in the event of a defect in materials or workmanship as follows (all time periods commence from the date of the original purchase):

PRODUCT	PARTS	LABOR
CAMCORDER	ONE (1) YEAR, EXCEPT CCD IMAGE SENSOR	NINETY (90) DAYS
	CCD IMAGE SENSOR - SIX (6) MONTHS	NINETY (90) DAYS
VCR	ONE (1) YEAR	NINETY (90) DAYS
A/V MIXER	ONE (1) YEAR	NINETY (90) DAYS
MONITOR-VCR	ONE (1) YEAR, EXCEPT CRT	NINETY (90) DAYS
	CRT - TWO (2) YEARS	CRT - NINETY (90) DAYS
		CUSTOMER PAYS ALL LABOR CHARGES AFTER 90 DAYS

Monitor-VCR In-home or carry-in Service: 22" (diagonal) CRT / LCD and Larger
Monitor-VCR Carry-in Service: 21" (diagonal) CRT / LCD and smaller

Batteries (if included) - New rechargeable batteries in exchange for defective rechargeable batteries for ten (10) days. Non-rechargeable batteries are not warranted.

Tape (if included) - New video cassette tape in exchange for a defective video cassette tape for five (5) days.

In-home, carry-in or mail-in service, as applicable, in the USA can be obtained during the warranty period by contacting a Panasonic Services Company (PASC) Factory Servicenter listed in the Service Directory. Or call toll free 1-800-211-PANA(7262), to locate an authorized PASC Servicenter. Carry-in or mail-in service in Puerto Rico can be obtained during the warranty period by calling the Panasonic Sales Company telephone number listed in the Servicenter Directory.

This warranty is extended only to the original purchaser. A purchase receipt or other proof of the date of the original purchase is required before warranty service is rendered.

This warranty only covers failures due to defects in materials and workmanship which occur during normal use and does not cover normal maintenance, including, but not limited to, video and audio head cleaning. The warranty does not cover damage which occurs in shipment, or failures which are caused by products not supplied by the warrantor, or failures which result from accident, misuse, abuse, neglect, mishandling, misapplication, alteration, modification, faulty installation, set-up adjustments, improper antenna, inadequate signal pickup, maladjustment of consumer controls, improper operation, power line surge, improper voltage supply, lightning damage, commercial use such as hotel, office, restaurant, or other business or rental use of the product, or service by anyone other than a PASC Factory Servicenter or a PASC authorized Servicenter, or damage that is attributable to acts of God.

LIMITS AND EXCLUSIONS

There are no express warranties except as listed above. THE WARRANTOR SHALL NOT BE LIABLE FOR INCIDENTAL OR CONSEQUENTIAL DAMAGES (INCLUDING, WITHOUT LIMITATION, DAMAGE TO TAPES) RESULTING FROM THE USE OF THIS PRODUCTS, OR ARISING OUT OF ANY BREACH OF THE WARRANTY. ALL EXPRESS AND IMPLIED WARRANTIES, INCLUDING THE WARRANTIES OF MERCHANTABILITY AND FITNESS FOR PARTICULAR PURPOSE, ARE LIMITED TO THE APPLICABLE WARRANTY PERIOD SET FORTH ABOVE. Some states do not allow the exclusion or limitation of incidental or consequential damages, or limitations on how long an implied warranty lasts, so the above exclusions or limitations may not apply to you.

This warranty gives you specific legal rights and you may also have other rights which vary from state to state.

If a problem with this product develops during or after the warranty period, you may contact your dealer or Servicenter. If the problem is not handled to your satisfaction, then write to the Customer Satisfaction Center at the Panasonic Consumer Electronics Company address above.

SERVICE CALLS WHICH DO NOT INVOLVE DEFECTIVE MATERIALS OR WORKMANSHIP AS DETERMINED BY THE WARRANTOR, IN ITS SOLE DISCRETION, ARE NOT COVERED. COSTS OF SUCH SERVICE CALLS ARE THE RESPONSIBILITY OF THE PURCHASER.

warvid 10/20/97

Warranty

For Product Information, Operating Assistance, Literature Request, Dealer Locations, and all Customer Service inquiries please contact:

1-800-211-PANA(7262), Monday-Friday 9am-9pm Saturday-Sunday 9am-7am, EST.

Web Site: <http://www.panasonic.com>

You can purchase parts, accessories or locate your nearest servicer by visiting our Web Site.

Accessory Purchases:

1-800-332-5368 (Customer Orders Only)

Panasonic Services Company 20421 84th Avenue South, Kent, WA 98032

(6 am to 5 pm Monday - Friday; 6 am to 10:30 am Saturday; PST)

(Visa, MasterCard, Discover Card, American Express, Check)

Product Repairs

Centralized Factory Servicer

MAIL TO :

Panasonic Services Company
1705 N. Randall Road,
Elgin, IL 60123-7847

Attention: Camcorder Repair

Please carefully pack and ship, prepaid and insured, to the Elgin centralized repair Factory Servicer. While there will be added handling delays, you may bring your unit to one of the following locations who will then forward the unit to Elgin for repair.

Customer's in Puerto Rico, please ship or carry in to location below ("Service in Puerto Rico").

Factory Servicers Locations

CALIFORNIA

6550 Katella Avenue
Cypress, CA 90630

800 Dubuque Avenue
S. San Francisco
CA 94080

20201 Sherman Way
Suite 102
Canoga Park, CA 91306

3878 Ruffin Road
Suite A
San Diego, CA 92123

COLORADO

1640 South Abilene
Street Suite D
Aurora, CO 80012

FLORIDA

3700 North 29th Avenue
Suite 102
Hollywood, FL 33020

GEORGIA

8655 Roswell Road
Suite 100
Atlanta, GA 30350

ILLINOIS

9060 Golf Road
Niles, IL 60714

1703 North Randall Road
Elgin, IL 60123
(Pick-up/drop-off only)

MARYLAND

62 Mountain Road
Glen Burnie, MD 21061

MASSACHUSETTS

60 Glacier Drive
Suite G
Westwood, MA 02090

MICHIGAN

37048 Van Dyke Avenue
Sterling Heights,
MI 48312

MINNESOTA

7850-12th Avenue South
Airport Business Center
Bloomington, MN 55425

OHIO

2236 Waycross Road
Civic Center Plaza
ForestPark, OH 45240

PENNSYLVANIA

2221 Cabot Blvd. West
Suite B
Langhorne, PA 19047

Chartiers Valley
Shopping Center
1025 Washington Pike
Bridgeville, PA 15017

TENNESSEE

3800 Ezell Road
Suite 806
Nashville, TN 37211

TEXAS

7482 Harwin Drive
Houston, TX 77036

13615 Welch Road
Suite 101
Farmers Branch, TX
75244

WASHINGTON

20425-84th Avenue
South
Kent, WA 98032

HAWAII

99-859 Iwaiwa Street
Aiea, Hawaii 96701
Phone (808) 488-1996
Fax (808) 486-4369

Service in Puerto Rico

Matsushita Electric of Puerto Rico, Inc. Panasonic Sales Company/ Factory Servicer:

Ave. 65 de Infanteria. Km. 9.5 San Gabriel Industrial Park Carolina, Puerto Rico 00985

Phone (787) 750-4300 Fax (787) 768-2910

Spanish Quick Use Guide/Guía Para Uso Rápido

PREPARATIVOS

- Conectar la videocámara a una fuente de alimentación (batería, adaptador de CA o cable para batería de coche).
- Encender el aparato.
- Introducir el casete en el compartimiento de casetes.

GRABACION

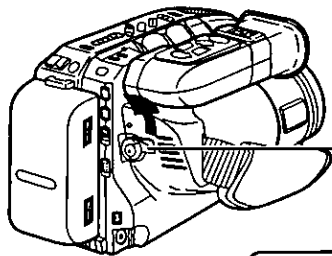

- 1** Fije el interruptor a la posición de CAMERA.

PAUSE

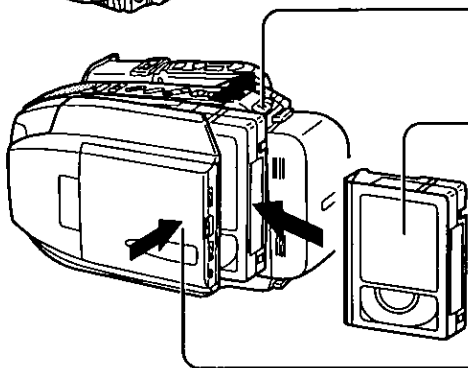

- 2** Deslice el botón EJECT para abrir la puerta.

PAUSE

- 3** Introduzca la cinta.

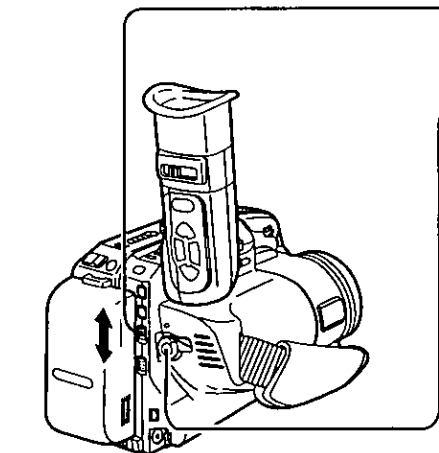

- 4** Cierre la puerta presionando el botón PUSH TO CLOSE.

- 5** Seleccionar la velocidad de grabación.

- 6** Oprimir el botón de grabación/pausa (RECORD/PAUSE) para comenzar a filmar.

REC

- 7** Volver a oprimir el botón de grabación/pausa (RECORD/PAUSE) cuando se desea hacer una pausa en la grabación.

PAUSE

Spanish Quick Use Guide/Guía Para Uso Rápido

- Conectar la videocámara a una fuente de alimentación (batería, adaptador de CA o cable para batería de coche).
- Encender el aparato.
- Introducir el casete en el compartimiento de casetes.

REPRODUCCION NORMAL

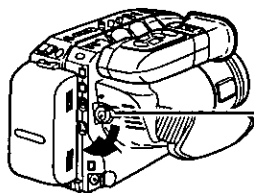

1 Fije el interruptor a la posición de VCR.

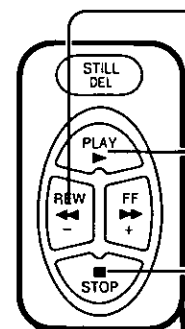

2 Rebobinar la cinta con el botón de rebobinado (REWIND) (si fuera necesario).

3 Oprimir el botón de reproducción (PLAY) para que aparezcan las imágenes en la pantalla.

4 Oprimir el botón de parada (STOP) cuando se desea parar la reproducción.

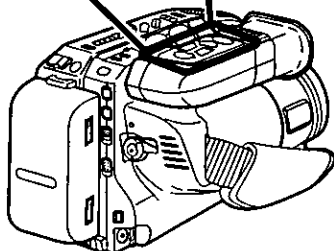

En el visor

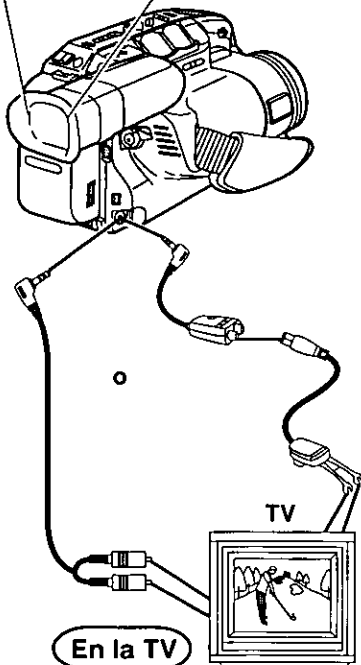

En la TV

REPRODUCCION CON EFECTOS ESPECIALES

PARA LOCALIZAR RAPIDAMENTE UNA ESCENA ESPECIFICA

- Oprimir el botón de localización (SEARCH).

PARA CONGELAR UNA IMAGEN

- Oprimir el botón de pausa/imagen fija (PAUSE/STILL).
- Oprimir nuevamente el botón cuando se desea continuar reproduciendo.

Panasonic Consumer Electronics
Company, Division of Matsushita
Electric Corporation of America
One Panasonic Way Secaucus,
New Jersey 07094

Panasonic Sales Company,
Division of Matsushita Electric of
Puerto Rico, Inc. ("PSC")
Ave. 65 de Infantería, Km. 9.5
San Gabriel Industrial Park
Carolina, Puerto Rico 00985

