

TOSHIBA

Color Television

OWNER'S MANUAL

CE20F10



SET UP

PREPARATION

BASIC OPERATION

ADVANCED
OPERATION

EQUIPMENT
CONNECTIONS

REFERENCE
SECTION

Dear Customer

Congratulations! You have purchased one of the finest Color TV's on the market!

This manual will help you use the many exciting and useful features to make your TV viewing more enjoyable than ever before.

Before operating your TV set, please read all these safety and operating instructions completely and then retain for future reference.

Customer's Record

You will find the model number and serial number on the back of your TV set.

Record these numbers in the spaces provided below. Refer to them whenever you call upon your TOSHIBA dealer regarding this product.

Model Number _____

Serial Number _____

Safety Precautions

WARNING:

TO REDUCE THE RISK OF FIRE OR ELECTRIC SHOCK, DO NOT EXPOSE THIS APPLIANCE TO RAIN OR MOISTURE.

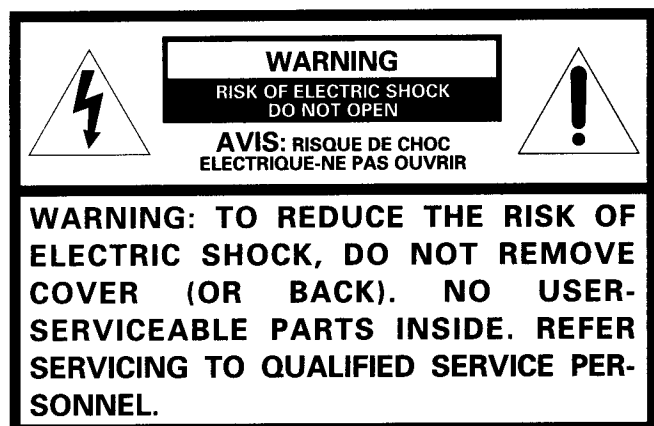

The lightning symbol in the triangle tells you that the voltage inside this product may be strong enough to cause an electric shock. **DO NOT TRY TO SERVICE THIS PRODUCT YOURSELF.**



The exclamation point in the triangle tells you that important operating and maintenance instructions follow this symbol.

CAUTIONS:

TO PREVENT ELECTRIC SHOCK, DO NOT USE THIS POLARIZED PLUG WITH AN EXTENSION CORD RECEPTACLE OR OTHER OUTLET UNLESS THE PRONGS CAN BE FULLY INSERTED INTO THE OUTLET TO PREVENT ANY EXPOSURE OF THE PRONGS ON THE POLARIZED PLUG.

ATTENTION:

POUR PRÉVENIR LES CHOCS ÉLECTRIQUES, NE PAS UTILISER CETTE FICHE POLARISÉE AVEC UN PROLONGATEUR, UNE PRISE DE COURANT OU UNE AUTRE SORTIE DE COURANT, SAUF SI LES LAMES PEUVENT ÊTRE INSÉRÉS À FOND SANS EN LAISSER AUCUNE PARTIE À DÉCOUVERT.

Avoid displaying stationary images on your TV screen for extended periods of time. Stationary patterns generated by computer displays, video games, stock market reports, etc. can become permanently engrained on the picture tube. This damage is not protected by your warranty as it is the result of misuse. Should you wish to use your TOSHIBA Television to display still images, it is always advisable to reduce brightness and contrast settings. Never leave a computer or video game display unattended.

NOTE TO CATV SYSTEM INSTALLER IN THE USA:

This reminder is provided to call the CATV system installer's attention to Article 820-40 of the NEC that provides guidelines for proper grounding and, in particular, specifies that the cable ground shall be connected to the grounding system of the building, as close to the point of cable entry as practical.

Table of Contents

Set Up

Installing Your TV Set	3
Antenna/Cable TV Connection	4

Preparation

Location of Controls (TV Set)	5
Location of Controls (Remote Control)	6
Menu Function (General Instructions)	7
Programming Channel Memory	8

Basic Operation

Watching TV Programs	10
Convenient Remote Functions	11
Selecting Stereo or Monaural Sound	12

Advanced Operation

Setting the Off-Timer (Sleep Timer)	13
Adjusting the Picture	14
Adjusting the Sound	15
Locking Channels	16
Using Closed-Captioned Function	18

Equipment Connections

Connecting Video Equipment	20
----------------------------------	----

Reference Section

Cleaning and Care	21
Specifications	21
Before Calling Service Personnel	22
Limited United States Warranty	23

Installing Your TV Set

Where to install

Place the TV on the floor or on a sturdy platform. The mounting surface should be flat and steady.

Lighting

Do not place the TV in a room where direct lighting strikes the screen. Use soft and indirect lighting.

Air circulation

Place the TV far enough from the walls to allow proper ventilation. This will prevent the TV from overheating and avoid possible damage to the TV. Avoid dusty places too.

Power supply

Plug into an electrical outlet with standard household power (120 volt AC, 60Hz). Do not change the plug's safety prong. See the right column.

WARNING : TO AVOID PERSONAL INJURY

- Do not stand or climb on the TV.
- Do not put a VCR or any heavy object on top of the TV.

CAUTION :

As a safety feature, the plug has one prong wider than the other. It will fit only one way into a standard electrical outlet. If the plug will not fit into the outlet, try turning it around. If the plug will not fit either way, the outlet is probably old and non-standard.

You will need to have a new outlet installed by an electrician. **DO NOT CHANGE THE SAFETY FEATURE OF THE PLUG.**

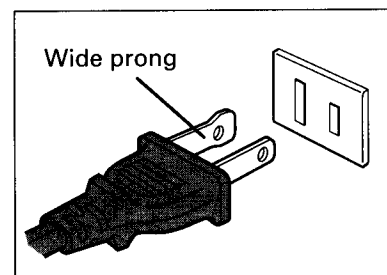

Antenna/Cable TV Connection

You can use either an indoor or outdoor antenna to receive VHF and/or UHF channels. Channels 2 - 13 are VHF channels, and channels 14 - 69 are UHF channels. We recommend using an outdoor antenna for better picture quality. You can receive Cable TV by connecting a cable supplied by your local cable company.

Connecting an antenna or Cable without a decoder box

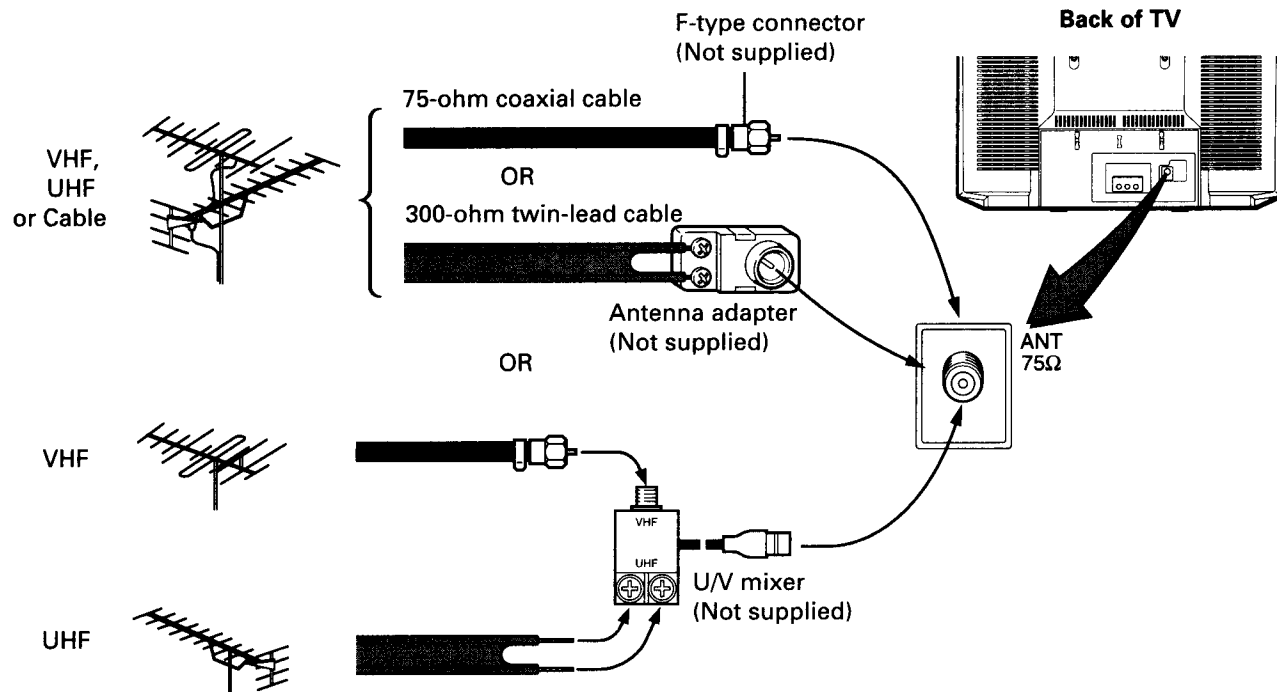

Connecting Cable with a decoder box

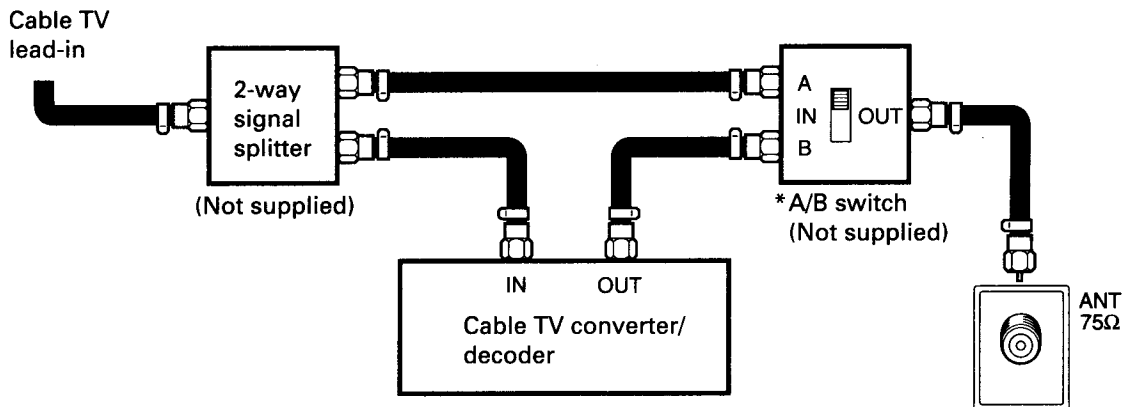

Notes:

- * "A" position on the A/B switch allows you to select unscrambled channels using the TV's channel keys.
- "B" position allows you to select scrambled channels via the converter/decoder box using the converter's channel keys. Place your TV on channel 3 or 4 to match the converter's output channel.
- If you use a VCR, connect its antenna in/out between the decoder box and A/B switch.

Location of Controls (TV Set)

For specific use of each control, consult the corresponding page numbers in brackets.

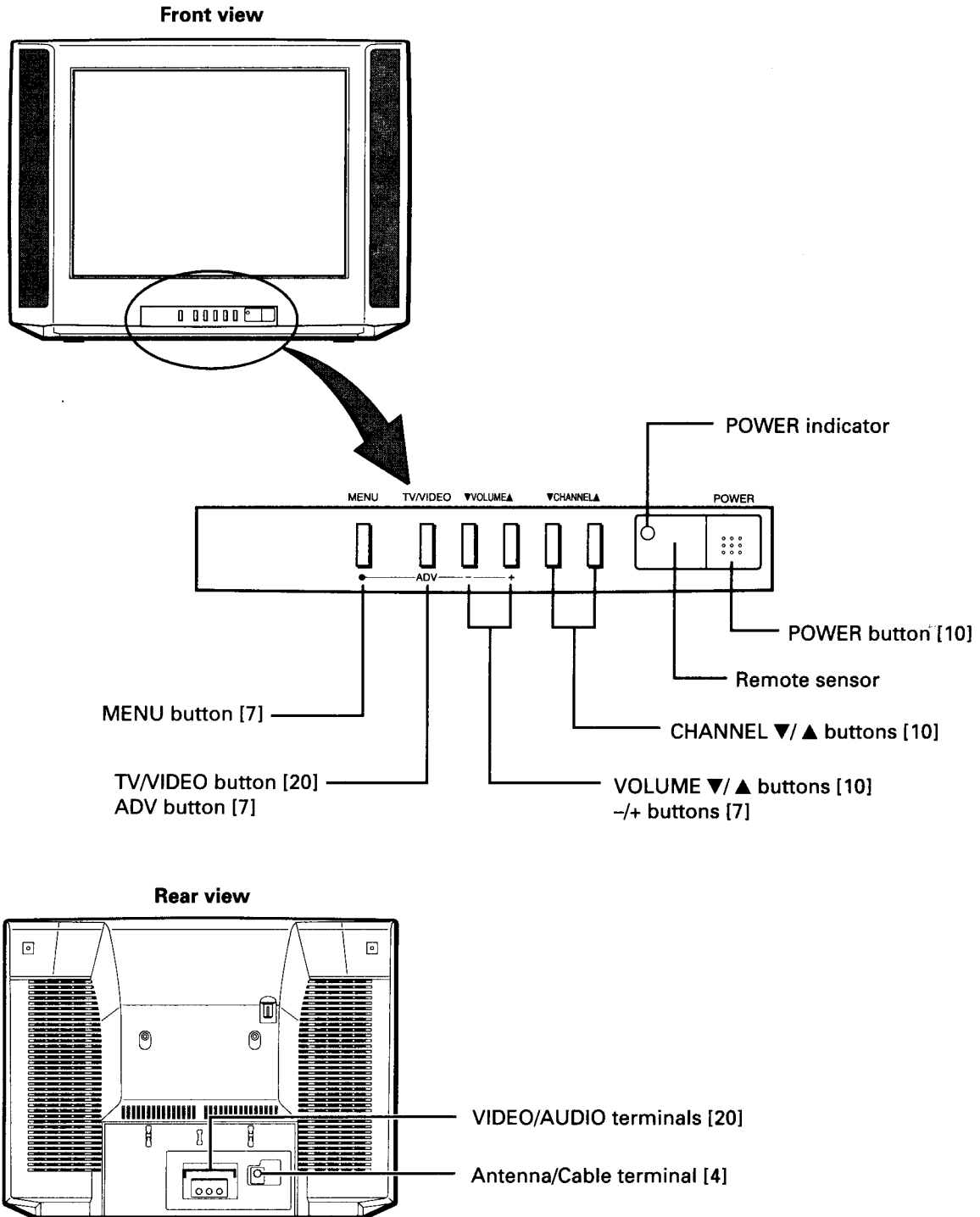

SET UP

PREPARATION

Antenna/Cable TV Connection
Location of Controls (TV Set)

Location of Controls (Remote Control)

This Remote Control allows you to control the functions of your TV set from 16 feet (5m) away. The "*" marked function buttons do not have duplicate locations on your TV set. They can be controlled only by the Remote Control. For the use of each control, refer to pages in brackets.

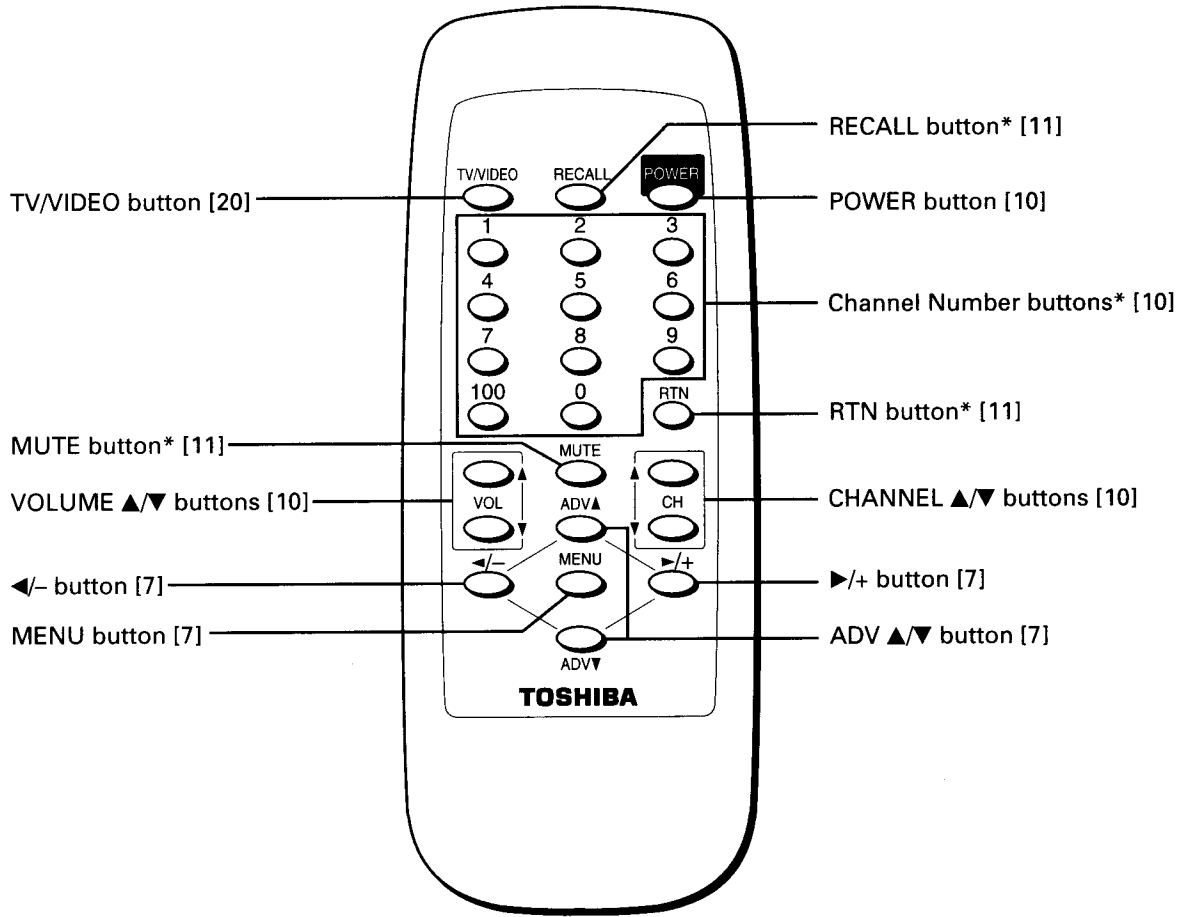

Installing and replacing batteries

- 1 Place the Remote Control with the face down, and remove the battery cover as shown.

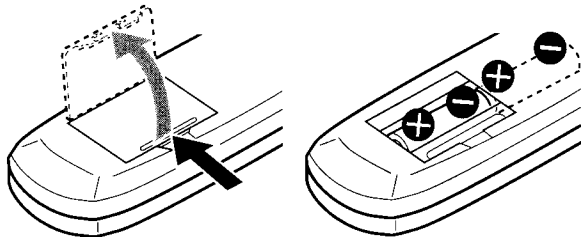

- 2 Place the two "AA" size batteries, matching the + and - signs on each battery to the + and - signs of the battery compartment.
- 3 Replace the battery cover until the lock snaps.

CAUTIONS:

- Do not throw your batteries into a fire. Dispose of your batteries in a designated disposal area.
- Do not combine used old batteries with new ones.
- Do not mix battery types.

Notes:

- If your Remote Control does not always adjust the set as you wish, you probably need to replace the batteries. The life expectancy of the battery is about one year.
- Remove dead batteries immediately to prevent battery acid from leaking into the battery compartment.
- If you do not intend to use the Remote Control for a long period, remove the batteries.

Menu Function (General Instructions)

We suggest you familiarize yourself with the procedure before using the Menu function. To adjust any TV feature, the use of the Menu function is required. The adjustments that can be made to the TV appear on the screen.

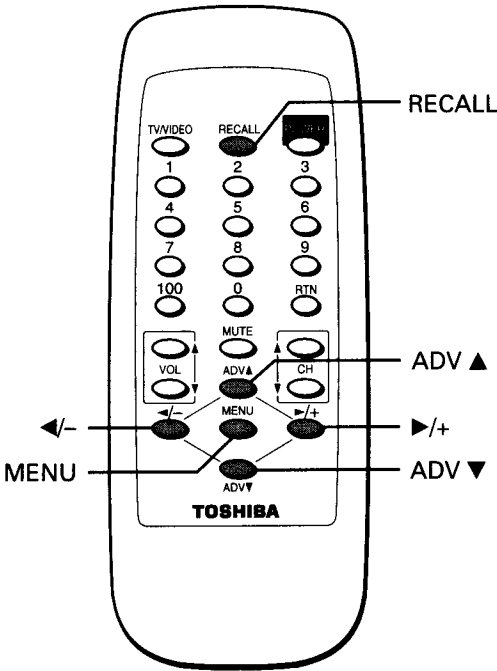
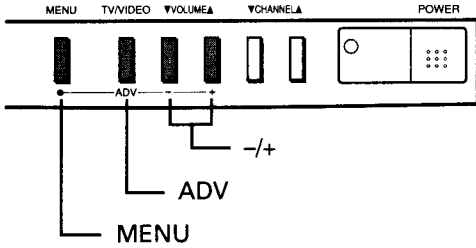

MENU button (on TV and on Remote)

Each time you press **MENU**, the Picture, Audio, Setup or Option menu on-screen display is selected in order, then press **ADV**.

Picture menu

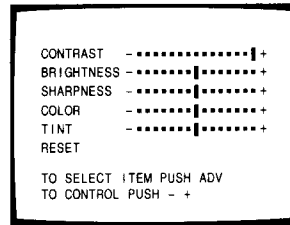

Audio menu

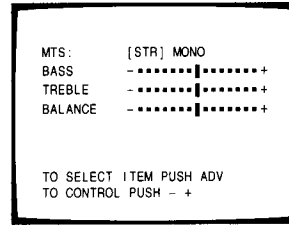

Option menu

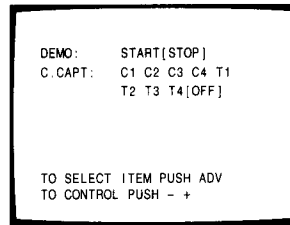

Setup menu

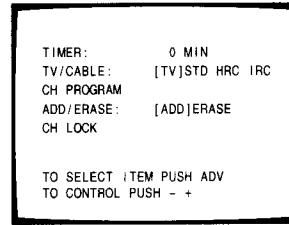

The above four menu displays will automatically disappear from the screen if no control has been operated for about 15 seconds.

ADV button (on TV and on Remote)

Use **ADV** after you have selected the on-screen menu you want to adjust with the **MENU** button.

Each time you press **ADV**, the function to be adjusted will be selected in order.

ADV ▲ button from bottom to top

ADV, ADV ▼ button from top to bottom

The selected function will be displayed in magenta.

◀/-, ▶/+ buttons (on TV and on Remote)

Use **◀/-** or **▶/+** to adjust the function you have selected with the **ADV** button.

RECALL button (on Remote)

The above four menu displays will automatically disappear from the screen if no control has been operated for about 15 seconds.

If you want to clear the Menu on-screen displays instantly, press **RECALL**.

Notes:

- The **ADV** button on the TV will function as the **TV/VIDEO** button when no menu display is on the screen.
- The **-/+** buttons on the TV will function as the **VOLUME ▼/▲** buttons when no menu display is on the screen.

Programming Channel Memory

The channel memory is the list of TV channel numbers your TV will stop on when you press the CHANNEL ▲ or ▼ button. **First, use the TV/CABLE and CH PROGRAM functions to preset all active channels in your area.** If necessary, arrange the preset channels with the ADD/ERASE function so that you can tune into only desired channels.

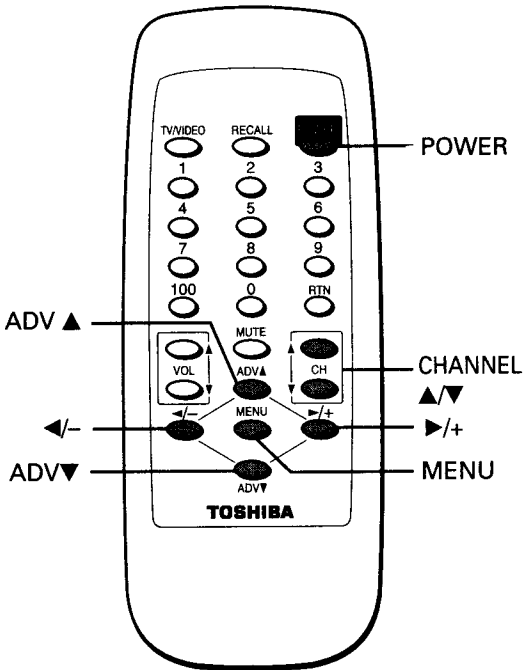
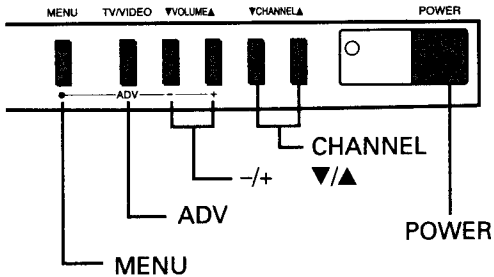

* This TV receives the following TV signals:

1. **TV:** TV broadcasts signals. (VHF channels 2 through 13 and UHF channels 14 through 69)
2. **STD CABLE:** Standard cable TV signals.
3. **HRC CABLE:** Harmonic Related Carrier cable TV signals.
4. **IRC CABLE:** Incremental Related Carrier cable TV signals.

If you are not sure what CABLE system they are using, consult your local cable company.

TV/CABLE function

- 1 Press **POWER** to turn on the TV.
- 2 Press **MENU** repeatedly until the Setup menu is displayed on the screen.
- 3 Press **ADV** repeatedly until "TV/CABLE" is displayed in magenta.
- 4 Press ◀/– or ▶/+ until the mode that corresponds to your TV signal system is displayed in magenta. Each time you press the button, the TV*, STD*, HRC* or IRC* mode will be selected in order.

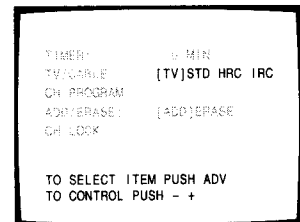
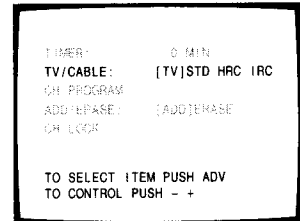

CH PROGRAM function

- 1 Press **MENU** repeatedly until the Setup menu is displayed on the screen.
- 2 Press **ADV** repeatedly until "CH PROGRAM" is displayed in magenta.
- 3 Press ◀/– or ▶/+ to start channel programming. The TV will automatically cycle through all the TV or CABLE channels depending on the mode selected, and store active channels in the channel memory.
- 4 When channel programming is complete, you will see the message at the right.
- 5 Press **CHANNEL ▲** or **▼** to make sure the channel programming has been done properly.

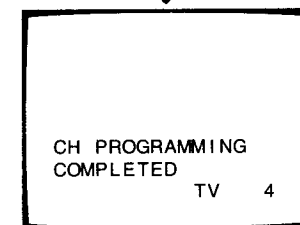
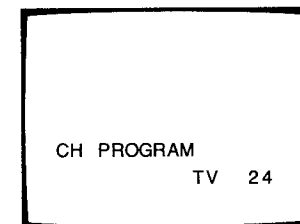
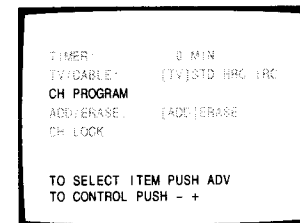

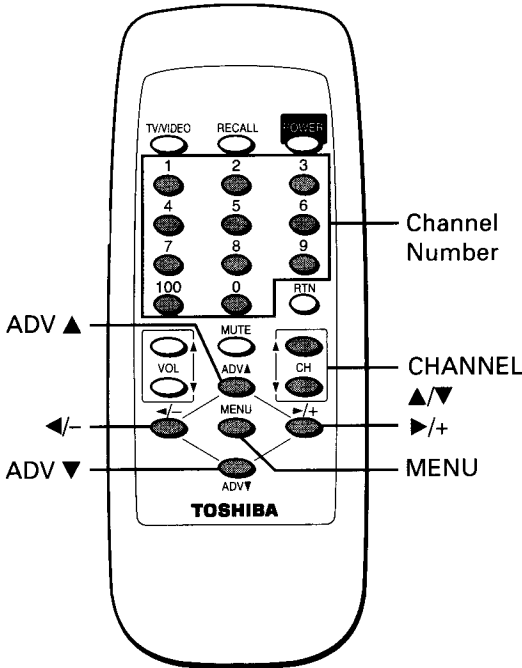
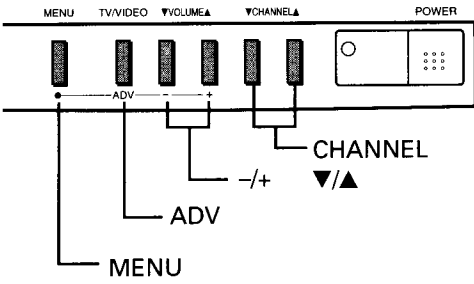

ADD/ERASE function

After performing the CH PROGRAM function, you can add or erase specific channels.

1 Select the channel you want to erase using the **CHANNEL ▲** or **▼** button, or select the channel you want to add using the **Channel Number** buttons.

2 Press **MENU** repeatedly until the Setup menu is displayed on the screen.

3 Press **ADV** repeatedly until "ADD/ERASE" is displayed in magenta.

4 Press **◀/-** or **▶/+** :
To erase the channel
 Press the button until "ERASE" is displayed in magenta indicating that the channel has been erased from the memory.

To add the channel
 Press the button until "ADD" is displayed in magenta indicating that the channel has been memorized.

5 Repeat steps 1 to 4 for other channels.

You have now completed the channel programming.

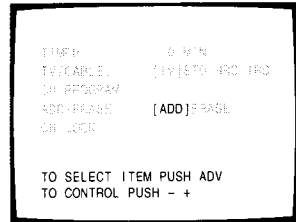
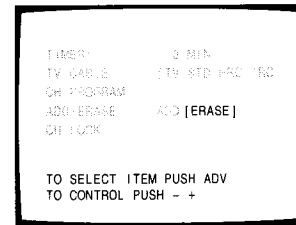
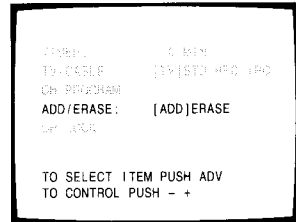

PREPARATION

Programming Channel Memory

CABLE channel reference chart

Number on this TV	1	5	6	14	15	16	34	35	36	37	38	60	61	62	63	64	65	66
Corresponding CABLE channel	A-8	5(A-7)	6(A-6)	A	B	C	U	V	W	AA	BB	XX	YY	ZZ	AAA	BBB	65	66
Number on this TV	67	68	69	92	93	94	95	96	97	98	99	100	101	102	123	124	125	
Corresponding CABLE channel	67	68	69	92	93	94	A-5	A-4	A-3	A-2	A-1	100	101	102	123	124	125	

The above chart is typical of many cable system channel allocations. If in doubt, consult your cable company.

Watching TV Programs

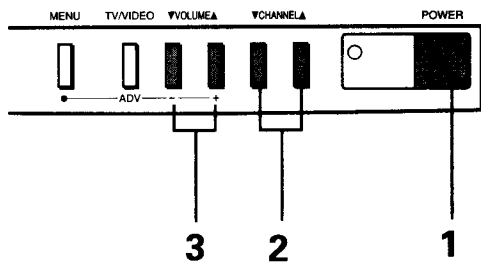

1 Press **POWER** to turn on the TV.

To turn off the TV, press **POWER** again.

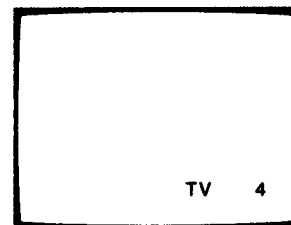

2 Select a channel in one of the following two ways.

- **To scan the memorized channels in numerical sequence**

Press **CHANNEL ▲** to select the next higher channel.

Press **CHANNEL ▼** to select the next lower channel.

Press the button again to select the next memorized channel.

- **To select a channel directly**

Press the **Channel Number** buttons (0-9 and 100).

To select channel 4, press "4" (or press "0", "4").

To select channel 38, press "3", "8".

To select channel 125, press "100", "2", "5" in sequence.

If you cannot select certain channels, either TV (off the air) or CABLE channels

Check if the TV/CABLE function is properly set. See page 8.

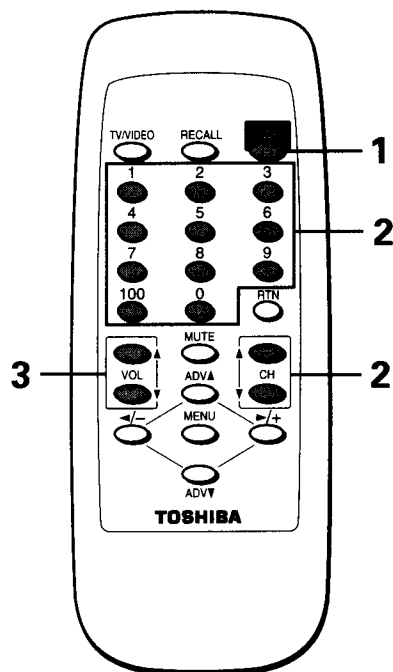

3 Press **VOLUME ▲/▼** to adjust the volume.

To increase the volume, press **▲**.

To decrease the volume, press **▼**.

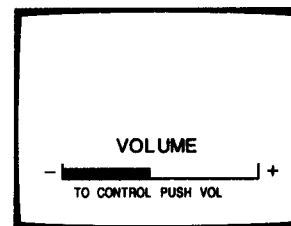

Watching Video Input

The TV/VIDEO button is used to view the signals coming from other devices like VCR's or Laserdisc Players connected to this TV.

Details are on page 20.

Note:

The VOLUME ▼/▲ buttons on the TV function as the -/+ buttons while any of the menu displays (Picture, Audio, Setup or Option) are on the screen.

Auto-Power-Off

If a vacant channel is tuned or TV broadcast for a day is finished, the TV will automatically turn off after about 15 minutes.

This feature does not operate in the VIDEO mode.

Last Mode Memory

If the power is cut off while you are viewing the TV and the power is resupplied, the TV is turned on automatically by the *Last Mode Memory* feature. If the power is going to be off or when you leave home for a long time, remove the power plug from the wall outlet to prevent the TV from turning on in your absence.

Demonstration Mode

When this function is activated, your TV will automatically display a variety of its on-screen menus and special features, this function is provided for demonstration purpose only.

To start the demonstration, select "DEMO [START]" in the Option menu. (See page 7.)

To stop, select "DEMO [STOP]" or press **POWER**.

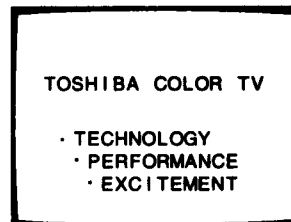

Convenient Remote Functions

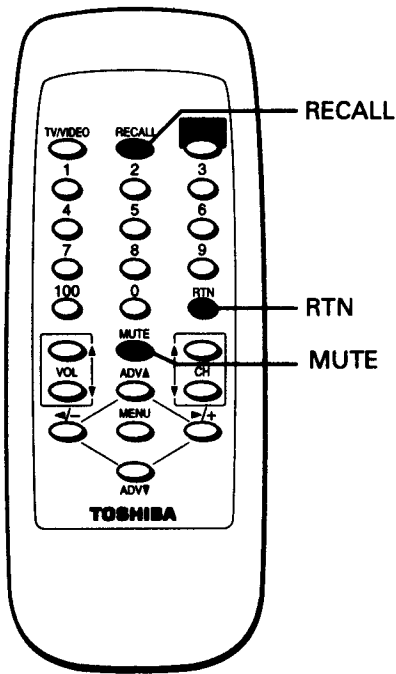

To display on-screen information

Press **RECALL** to display the following on-screen information.

- Channel number
- VIDEO mode selected
- Stereo status
- Closed Caption or Text program status

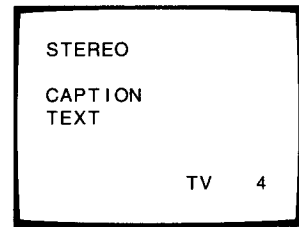

To mute the sound

Press **MUTE** to mute the sound. The word "MUTE" will be displayed on the screen as shown. This is useful during telephone calls or other interruptions.

To restore the sound, press **MUTE** again.

Note: When the MUTE button is pressed, the Closed-Captioned feature "C1" is activated. ("MUTE" on the screen display will disappear.) To deactivate, press the MUTE button again. (This feature only functions when the Closed Caption mode is set to "OFF".)

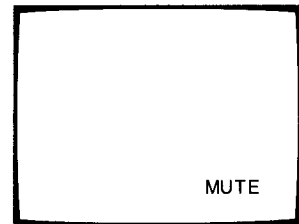

To change quickly between two channels

Press **RTN** to return to the last channel viewed.

This is useful should you want to view two channels. This allows you to view two programs without entering an actual channel number each time.

To operate this function

- 1 Select the first channel you want to view.
- 2 Select the other channel with the Channel Number buttons.
- 3 Press **RTN**.
The previous channel will return.

Each time you press **RTN**, the TV will switch back and forth between the two channels.

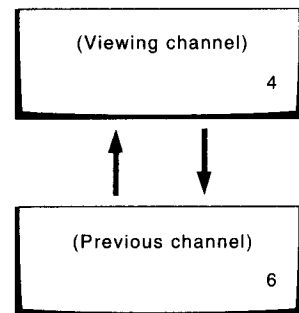

Selecting Stereo or Monaural Sounds

The MTS (Multi-channel TV Sound) feature allows you to improve your TV viewing with high fidelity stereo sound. This TV also allows you to activate or deactivate the stereo sound effect.

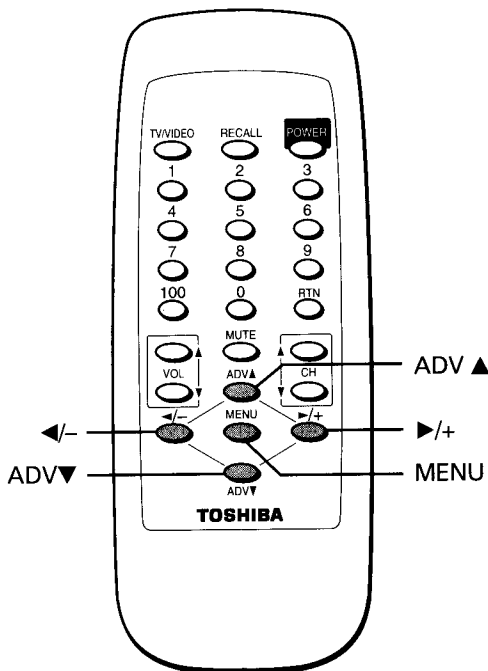
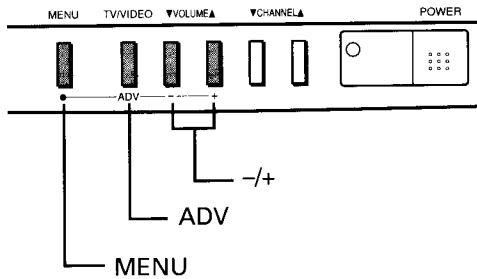

To listen to stereo sound

- 1 When the TV receives a stereo broadcast, the word "STEREO" is displayed on the screen whenever the TV is turned on, a channel is selected, or the RECALL button is pressed.
- 2 Press **MENU** repeatedly until the Audio menu is displayed on the screen.
- 3 Press **ADV** repeatedly until "MTS" is displayed in magenta. If a stereo broadcast is received, "STR" will be displayed in yellow.
- 4 Press **◀/-** or **▶/+** until "STR" (stereo) is displayed in magenta.

Normally this function can be left in the STR mode. Your TV will then automatically reproduce either stereo or monaural sound, whichever is broadcast.

If the stereo sound is noisy

Be sure you have selected the STR mode if broadcast is in stereo. However, if a broadcast signal is not strong enough, and noise-free stereo sound is not available, select "MONO" (monaural) mode. The noise should be reduced.

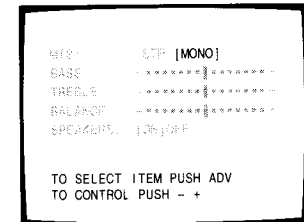
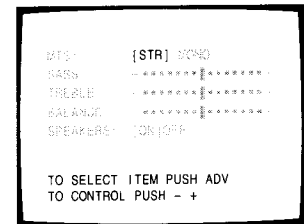
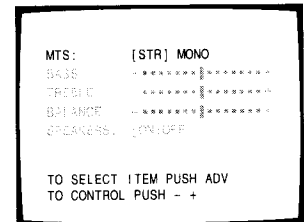
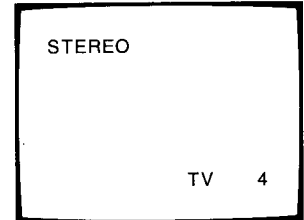

Setting the Off-Timer (Sleep Timer)

With the off-timer, you can set the TV to turn off automatically after a pre-determined period of time (up to 180 minutes in 10 minute units).

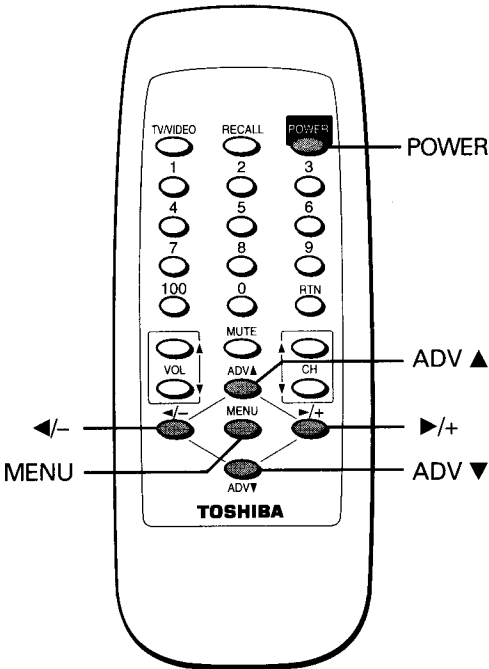
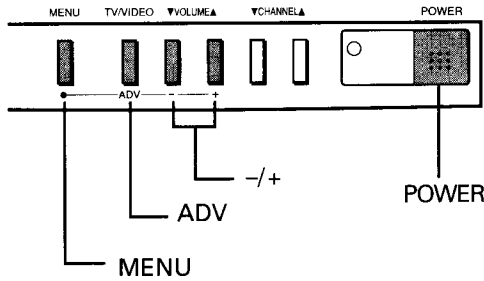

To set the off-timer

1 Press **MENU** repeatedly until the Setup menu is displayed on the screen.

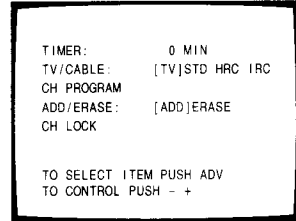

2 Press **ADV** repeatedly until "TIMER" is displayed in magenta.

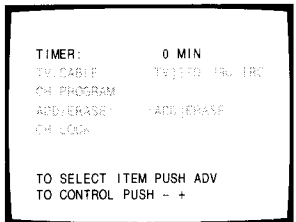

3 Press **◀/−** or **▶/+** to enter the length of time you want the TV to stay on. Each time you press the button, the time display will increase (▶/+) or decrease (◀/−) by 10 minutes.

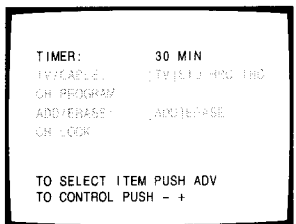

To cancel the setting

Press **POWER** twice, once to turn the TV off and once to turn it on again.

Selecting Stereo or Monaural Sound/
Setting the Off-Timer (Sleep Timer)

BASIC OPERATION

ADVANCED OPERATION

Adjusting the Picture

You can adjust the picture quality (CONTRAST, BRIGHTNESS, SHARPNESS, COLOR and TINT) to suit your taste.

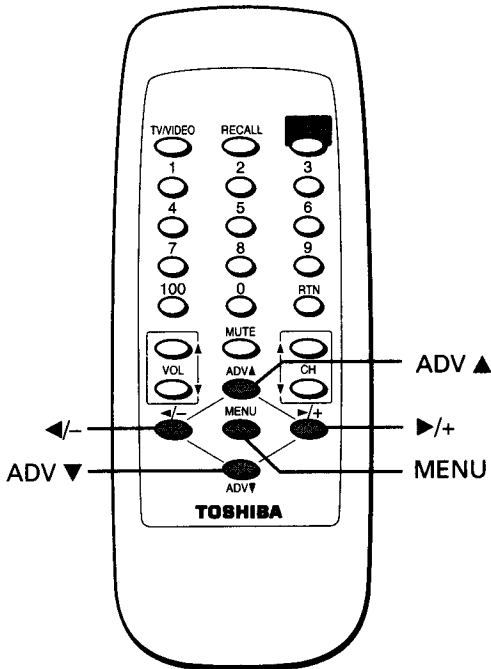
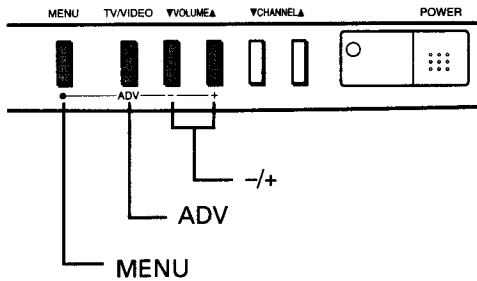

To adjust the picture quality

- 1 Press **MENU** repeatedly until the Picture menu is displayed on the screen.
- 2 Press **ADV** repeatedly until the item you want to adjust is displayed in magenta.
- 3 Press **◀/-** or **▶/+** to adjust the level.

Example: CONTRAST adjustment mode display

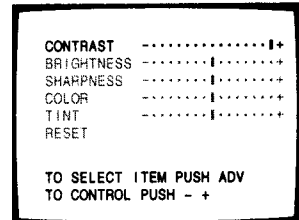
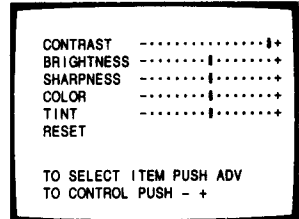

Selection	◀/-	▶/+
CONTRAST	lower	higher
BRIGHTNESS	darker	lighter
SHARPNESS	softer	sharper
COLOR	paler	deeper
TINT	reddish	greenish

RESET function

To reset the picture and sound adjustments to the factory-preset level (maximum CONTRAST and all other adjustments centered)

- 1 Press **MENU** repeatedly until the Picture menu is displayed on the screen.
- 2 Press **ADV** repeatedly until "RESET" is displayed in magenta.
- 3 Press **◀/-** or **▶/+**.

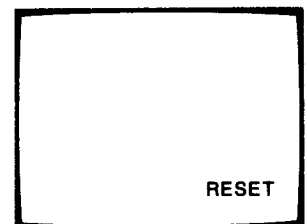
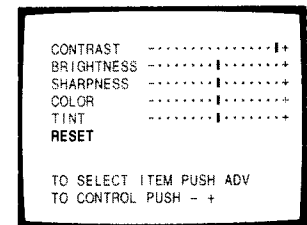

Adjusting the Sound

You can adjust the sound quality (BASS, TREBLE and BALANCE) to suit your taste.

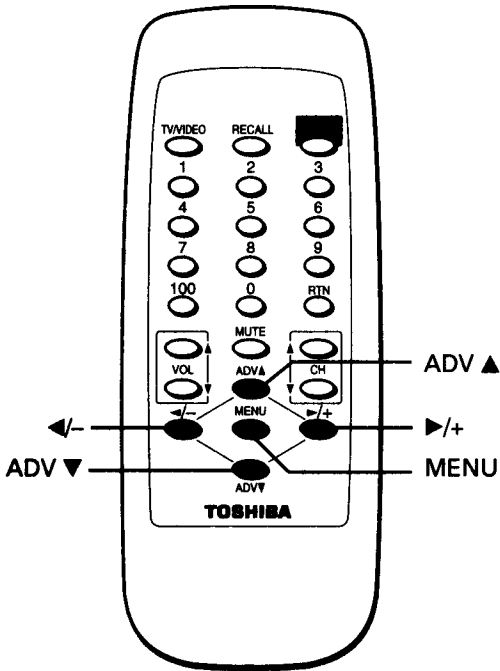
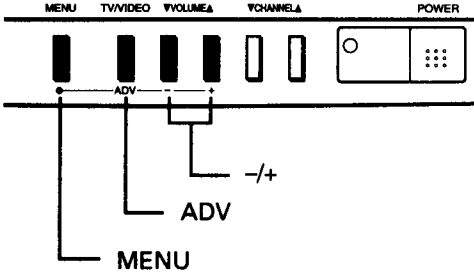

To adjust the sound quality

- 1 Press **MENU** repeatedly until the Audio menu is displayed on the screen.
- 2 Press **ADV** repeatedly until the item you want to adjust is displayed in magenta.
- 3 Press **◀/−** or **▶/+** to adjust the level.

Example: BASS adjustment mode display

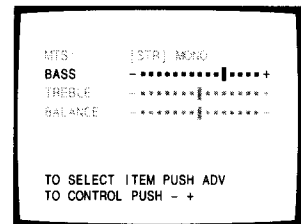
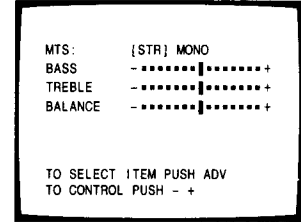

Selection	Pressing	
	◀/−	▶/+
BASS	weaker	stronger
TREBLE	weaker	stronger
BALANCE	decreases the right channel	decreases the left channel

To reset the sound adjustments to the factory-preset level
 Activate the RESET function. (See page 14.)
 (maximum CONTRAST and all other adjustments centered)

Locking Channels

With this function you can lock out specific channels (for example a channel that you do not want your children to watch) by entering your own 4-digit code. The TV will not be able to tune them for the next 24 hours, unless you cancel the locked out channels. This TV has 4 memory spaces total for the TV mode and CABLE mode respectively.

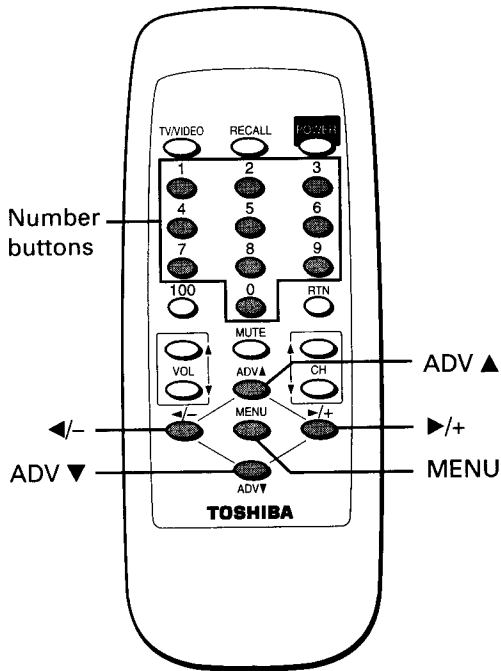
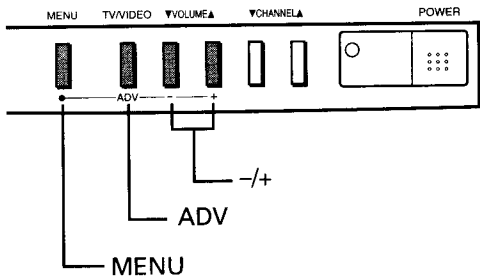

To lock out channels

1 Select a channel you want to lock out.

Example: channel 4

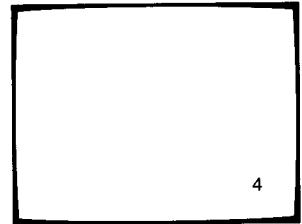

2 Press **MENU** repeatedly until the Setup menu is displayed on the screen.

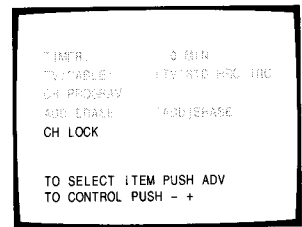

3 Press **ADV** repeatedly until "CH LOCK" is displayed in magenta.

4 Press **◀/–** or **▶/+** to call up the channel lock adjustment display shown below. Each time you press the button, you are guided between "SET" and "CLEAR". Select "SET"

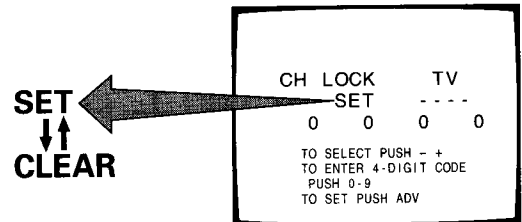

5 Press Number buttons (0 - 9) to enter a 4-digit code. The numbers you enter will replace the dashes in the display. **Pick a number that is easy to remember.**

Example: To enter "1234"

Press 1, 2, 3 and 4 in order.

1 - - - → 1 2 - - → 1 2 3 - → 1 2 3 4

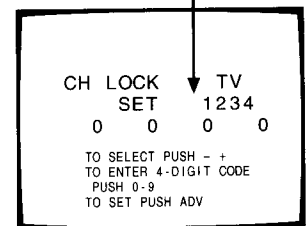

- 6** Press **ADV** to lock out the channel.
The display at the right will appear on the screen for about 4 seconds.

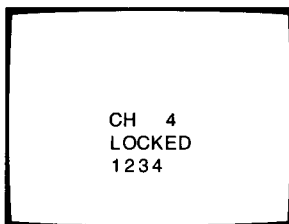

- 7** Repeat steps 1 to 6 for other channels.
This TV has 4 memory spaces total for the TV mode and CABLE mode respectively.

Note: If a different code number is used whenever you lock out a channel, the last one has priority over the preceding ones.

- 8** Select another channel.

To restore channels

- 1** Select "CLEAR" following the steps 2 to 4 on the previous page.

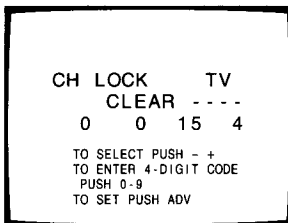

- 2** Press the 4-digit code used to lock out the channels with the Number buttons.

- 3** Press **ADV**.
If you have entered the correct code
The display shown at the right appears.

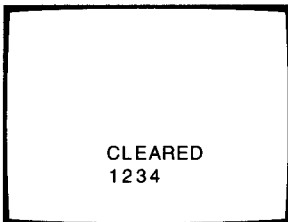

If a wrong code has been entered
These messages appear. Try to enter the correct code again.

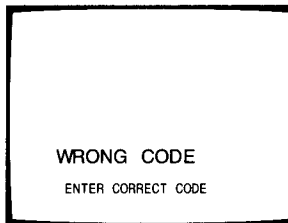

If you want to know the channels you have locked out
Call up the channel lock adjustment mode using the Setup menu.

Using Closed-Captioned Function

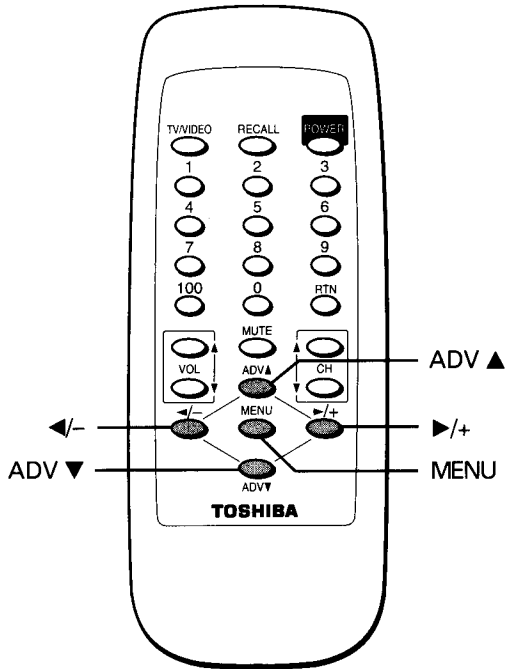
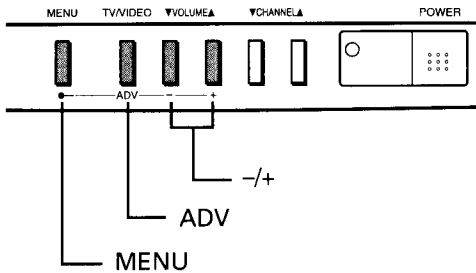
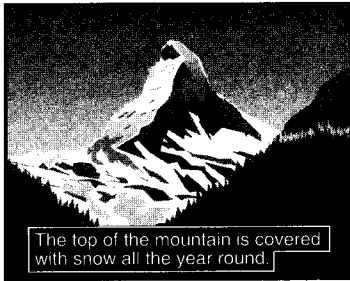

Note:

- A closed-captioned signal may not be decoded in the following situations.
- When a video tape has been dubbed.
 - When the signal reception is weak.
 - When the signal reception is non-standard.

To view captions

Closed-captioning is a printed version of the dialogue, narration, and/or sound effects of a TV program. Captions will appear at either the top or bottom of the screen during captioned broadcasts as shown. Captioning is especially helpful for hearing impaired individuals.

- 1 Select the desired program.
- 2 Press **RECALL** to check if the program is being captioned. If it is, the word "CAPTION" is displayed on the screen. The captioned programs are usually notated on your local TV listings by its service marks such as "CC".

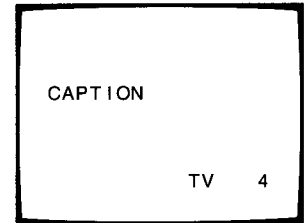

- 3 Press **MENU** repeatedly until the Option menu is displayed on the screen.

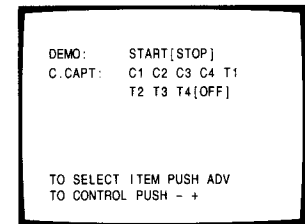

- 4 Press **ADV** repeatedly until "C.CAPT" is displayed in magenta.

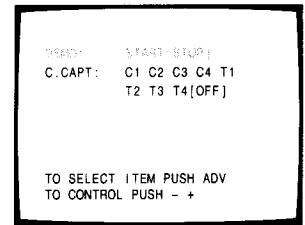

- 5 Press **←/−** or **→/+** to select "C1", "C2", "C3" or "C4".

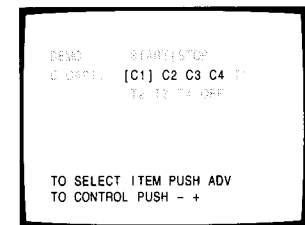

To deactivate this feature
Select "OFF" in step 3 above.

To view text

Text is information that is presented using from one half to full television screen. It is usually not related to the program. For example, it could be a listing of the closed-captioned programs, news, weather information or stock market reports.

- 1 Select the desired program.
- 2 Press **RECALL** to check if the program includes text information. If it is, the word "TEXT" is displayed on the screen.

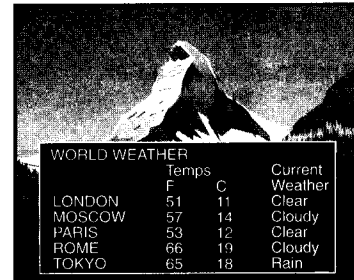
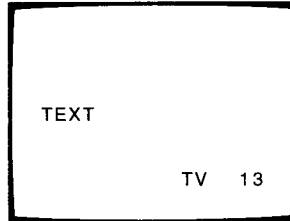

WORLD WEATHER			
	Temps		Current
	F	C	Weather
LONDON	51	11	Clear
MOSCOW	57	14	Cloudy
PARIS	53	12	Clear
ROME	66	19	Cloudy
TOKYO	65	18	Rain

- 3 Press **MENU** repeatedly until the Option menu is displayed on the screen.

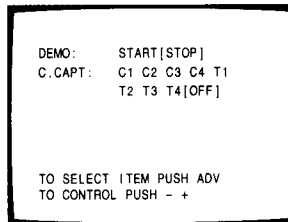

- 4 Press **ADV** repeatedly until "C.CAPT" is displayed in magenta.

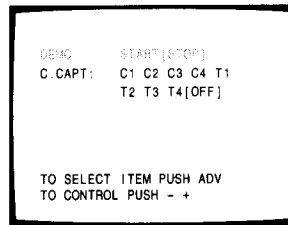

- 5 Press **←/−** or **→/+** to select "T1", "T2", "T3" or "T4".

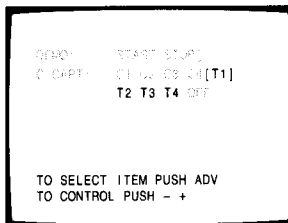

To deactivate this feature

Select "OFF" in step 3 above.

Note: If you select a closed-captioned channel and the "TEXT" mode, the text screen always appears. However, text characters are not displayed when no signal is aired.

Connecting Video Equipment

Connect VIDEO/AUDIO IN jacks on the rear of the TV to the video/audio output jacks of a VCR, Laserdisc player, etc. for playback of video material.

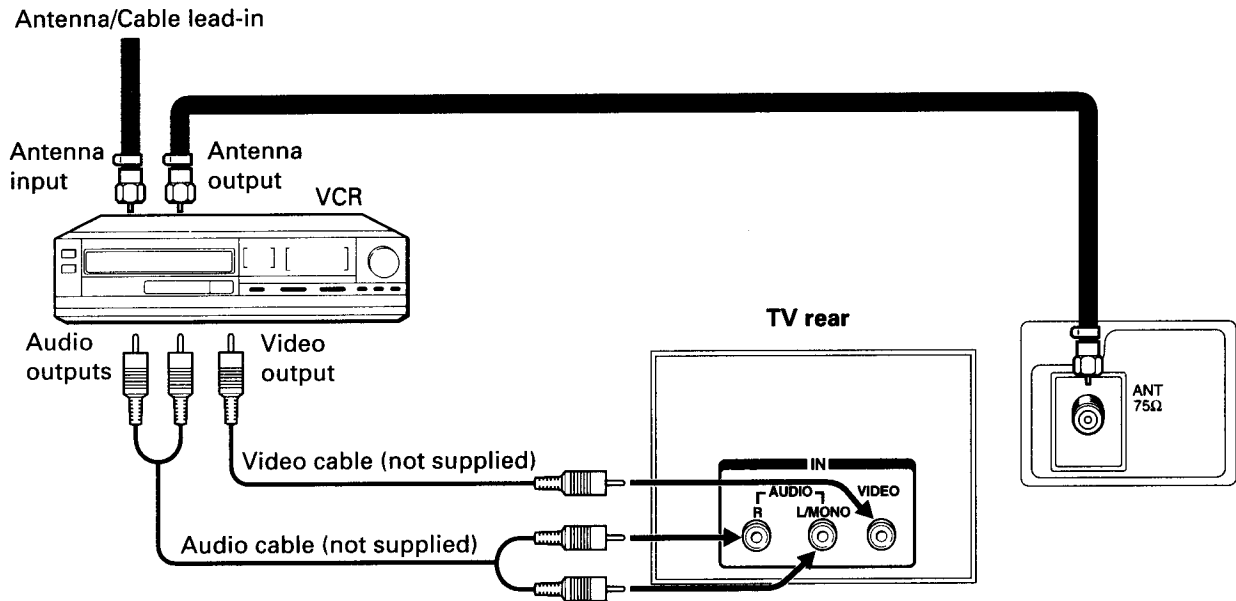

Selecting video input source

To operate your TV and video equipment properly, refer to the instructions furnished with the video equipment.

- 1 Turn the TV and the video equipment ON.
- 2 Press **TV/VIDEO** on the Remote Control or on the TV to select "VIDEO". Each time you press the button, TV or VIDEO source will be selected alternately. The selected source will be displayed in magenta.
- 3 Operate the video equipment normally.

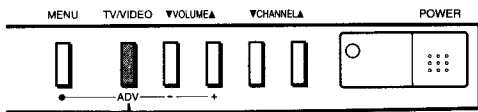
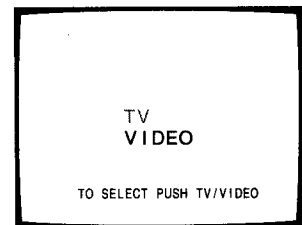

TV/VIDEO

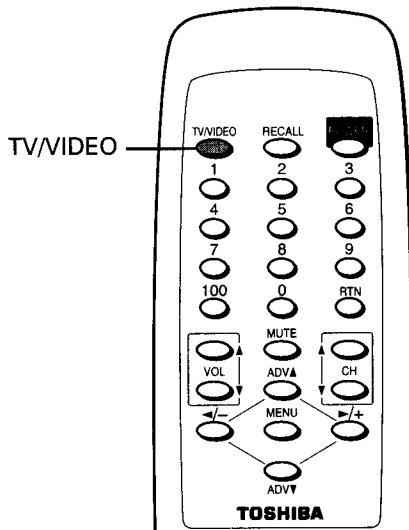

Note: If you connect a monaural video equipment, connect the audio output of the video equipment to the L/MONO jack on the TV.

Cleaning and Care

WARNING: TV sets use High Voltage. Do not try to remove the cabinet back. Refer servicing to qualified service personnel.

- To clean the TV screen:
 1. First remove the plug from the power outlet to avoid possible shock hazard.
 2. Use a clean cellulose sponge or chamois cloth dampened with a solution of mild detergent and warm water to clean TV screen and trim. Do not use too much water on the TV screen. Water spills into the cabinet and may cause damage to the TV. Avoid excess water.
 3. Remove any extra moisture with the same cloth or a dry one.
 - To maintain the finish and appearance of the cabinet, polish it from time to time with a quality furniture polish.
- Caution:** Never use strong solvents such as thinner, benzene or other chemicals on or near cabinet, as they might damage the finish of the cabinet.

Specifications

TELEVISION SYSTEM:	NTSC standard
CHANNEL COVERAGE:	VHF; 2 through 13 UHF; 14 through 69 Cable TV; mid band (A-8 through A-1, A through I) super band (J through W) hyper band (AA through ZZ, AAA, BBB) ultra band (65 through 94, 100 through 125)
POWER SOURCE:	120V AC, 60Hz
POWER CONSUMPTION:	56W (average)
AUDIO POWER:	2W + 2W
SPEAKER TYPE:	Two 2 x 3-1/2 inches (5 x 9 cm) oval
VIDEO/AUDIO INPUTS:	VIDEO: 1V(p-p), 75 ohm, negative sync. AUDIO: 150mV(rms) (30% modulation equivalent, 47k ohm)
DIMENSIONS:	Width 23-13/16 inches (605mm) Height 18-17/64 inches (464mm) Depth 18-7/16 inches (468mm)
MASS:	44.1 lbs. (20.0 kg)
SUPPLIED ACCESSORIES:	Remote Control with 2 size "AA" batteries

Design and specifications are subject to change without notice.

Connecting Video Equipment
Cleaning and Core/ Specifications

EQUIPMENT
CONNECTIONS

REFERENCE
SECTION

Before Calling Service Personnel

Before calling service personnel, please check the following chart for a possible cause of the problem you are experiencing. A minor adjustment on your part may eliminate the problem and restore your TV reception.

Symptoms	Check	Adjustments
● No picture, no sound	<ul style="list-style-type: none"> ● Be sure power cord is plugged in. ● May be station trouble. ● Check antenna connections. ● Check antenna for broken wires. 	<ul style="list-style-type: none"> ● Press POWER button. ● Try another channel.
● No sound, picture OK	<ul style="list-style-type: none"> ● May be station trouble. 	<ul style="list-style-type: none"> ● Try another channel. ● Adjust VOLUME.
● Poor sound, picture OK	<ul style="list-style-type: none"> ● May be station trouble. ● Check antenna connections. ● May be local interference from appliance. 	<ul style="list-style-type: none"> ● Try another channel. ● Adjust VOLUME. ● Adjust BASS, TREBLE, or BALANCE control. ● Re-orient antenna.
<ul style="list-style-type: none"> ● Poor picture, sound OK ● Snowy picture ● Lines in picture ● Distorted picture ● Weak picture 	<ul style="list-style-type: none"> ● May be local interference from appliance. ● Check antenna connections. ● Check antenna for broken wires. ● May be station trouble. 	<ul style="list-style-type: none"> ● Try another channel. ● Adjust BRIGHTNESS. ● Adjust CONTRAST. ● Adjust SHARPNESS. ● Re-orient antenna.
● Poor reception of broadcast channels	<ul style="list-style-type: none"> ● Check antenna connections. ● Check antenna for broken wires. ● If VCR is connected, check TV/VCR switch. 	<ul style="list-style-type: none"> ● Try another channel. ● Re-orient antenna.
● No UHF, VHF OK	<ul style="list-style-type: none"> ● Be sure TV/CABLE function (page 8) is in "TV" mode. 	
● Unable to select a certain channel	<ul style="list-style-type: none"> ● That channel may be locked out with CH LOCK function (page 16), or erased with the ADD/ERASE function (page 9). 	
● Multiple images (ghosts)	<ul style="list-style-type: none"> ● May be station trouble. ● Check antenna connections. 	<ul style="list-style-type: none"> ● Try another channel. ● Re-orient antenna.
● Poor color or No color	<ul style="list-style-type: none"> ● May be station trouble. ● Check antenna connections. ● Check antenna for broken wires. ● May be local interference from appliance. ● Check if station is broadcasting in color. ● If you change the direction of the TV while the TV is activated, the picture may suffer from color shading. If so, turn off the TV and allow to cool for about 30 minutes, then turn on the TV again. The picture should improve. 	<ul style="list-style-type: none"> ● Try another channel. ● Re-orient antenna. ● Adjust TINT. ● Adjust COLOR.
● No stereo sound from a known MTS broadcast	<ul style="list-style-type: none"> ● Be sure MTS function is in "STR" mode. 	
● Remote Control does not work	<ul style="list-style-type: none"> ● Be sure power cord is plugged in. ● Check battery in Remote Control. 	<ul style="list-style-type: none"> ● Change batteries.

Limited United States Warranty

Toshiba America Consumer Products, Inc. ("TACP") and Toshiba Hawaii Inc. ("THI") make the following limited warranties. These limited warranties extend to the original consumer purchaser or any person receiving this set as a gift from the original consumer purchaser and to no other purchaser or transferee.

Limited Ninety (90) Day Warranty

TACP and THI warrant this product and its parts against defects in materials or workmanship for a period of ninety (90) days after the date of original retail purchase. During this period, TACP and THI will repair a defective product or part, without charge to you. You must deliver the entire set to an Authorized TACP/THI Service Station. You pay for all transportation and insurance charges for the set to and from the Service Station.

Limited One (1) Year Warranty

TACP / THI further warrant the parts in this product against defects in materials or workmanship for a period of one year after the date of original retail purchase. During this period TACP/THI will replace a defective part without charge to you, except that if a defective part is replaced after ninety (90) days from the date of original retail purchase you pay labor charges involved in the replacement. You must also deliver the entire product to a TACP/THI Authorized Service Station. You are responsible for all transportation for the set to and from the Service Station.

Limited Two (2) Year Warranty of Picture Tube

TACP and THI further warrant the picture tube in this product against defects in materials or workmanship for a period of two (2) years after the date of original retail purchase. During this period, TACP/THI will replace a defective picture tube without charge to you, except that if a defective picture tube is replaced after ninety (90) days from the date of original retail purchase, you pay labor charges involved in the replacement. You are responsible for all transportation and insurance charges for the set to and from the Service Station.

Rental Units

The warranty for rental units begins with the first rental or thirty (30) days from the date of shipment to the rental firm, whichever comes first.

How to Obtain Warranty Service

If after following all of the operating instructions in this manual and checking the section "BEFORE CALLING SERVICE PERSONNEL", you find that service is needed;

- (1) In the U.S.A. call the TACP toll free number **1-800-631-3811** after you find a defective product or part to locate the nearest Toshiba Authorized Service Station.
- (2) Arrange for the delivery of the product to the Authorized TACP/THI Service Station. Products shipped to the Authorized Service Station must be insured and safely and securely packed, preferably in the original carton, and a letter explaining the problem must be enclosed. You are responsible for all transportation and insurance charges to and from the Authorized Service Station.

In the Continental United States call:



HAWAII, 327 Kamakee Street, Honolulu, HA 96814
(808) 521-5377

All warranties implied by state law, including the implied warranties of merchantability and fitness for a particular purpose, are expressly limited to the durations of the limited warranties set forth above. With the exception of any warranties implied by state law as hereby limited, the foregoing warranty is exclusive and in lieu of all other warranties, guarantees, agreements and similar obligations of manufacturer or seller with respect to the repair or replacement of any parts. In no event shall TACP or THI be liable for consequential or incidental damages.

No person, agent, distributor, dealer or company is authorized to change, modify or extend the terms of these warranties in any manner whatsoever. The time within which action must be commenced to enforce any obligation of TACP or THI arising under this warranty or under any statute, or law of the United States or any state thereof, is hereby limited to 90 days from the date you discover or should have discovered, the defect. This limitation does not apply to implied warranties arising under state law.

This warranty gives you specific legal rights and you may also have other rights which may vary from state to state. Some states do not allow limitation on how long an implied warranty lasts, when an action may be brought, or the exclusion or limitation of incidental or consequential damages, so the above provisions may not apply to you.

ATTENTION CANADIAN CONSUMERS:

Canadian consumers are requested to complete the special Canadian "Warranty Registration Form" enclosed, and forward this completed form with a copy of bill of sale to TOSHIBA OF CANADA to "Register and Validate" their warranty. Product must be purchased from an Authorized Canadian Dealer.

Products purchased in the U.S.A. and used in Canada are not covered by these warranties.

Products purchased in Canada and used in the U.S.A. are not covered by these warranties.

Commercial Units

Products sold and used for commercial use have a limited ninety (90) day warranty for all parts, labor and picture tube.

Owner's Manual and Demographic Card

You should read this owner's manual thoroughly before operating this product. You should complete and mail the enclosed Demographic card within ten days after you, or the person who has given you this product as a gift, purchased this product. This is one way to enable TACP/THI to provide you with better customer service and improved products. Failure to return the Demographic card will not affect your rights under the manufacturer's limited warranty.

Your Responsibility

The above warranties are subject to the following conditions:

- (1) You must retain your bill of sale or provide other proof of purchase.
- (2) All warranty servicing of this product must be made by an Authorized TACP/THI Service Station.
- (3) **These warranties are effective only if the product is purchased and operated in the U.S.A. or Puerto Rico.**
- (4) Labor service charges for set installation, set up, adjustment of customer controls and installation or repair of antenna systems are not covered by this warranty. Reception problems caused by inadequate antenna systems are your responsibility.
- (5) Warranties extend only to defects in materials or workmanship as limited above and do not extend to any product or parts which have been lost or discarded by you or to damage to products or parts caused by misuse, accident, damage caused by Acts of God, such as lightning or fluctuations in electric power, improper installation, improper maintenance or use in violation of instructions furnished by us; or to units which have been altered or modified without authorization of TACP/THI.

Before Calling Service Personnel/ Limited United States Warranty

REFERENCE SECTION

TOSHIBA AMERICA CONSUMER PRODUCTS, INC.

HEAD OFFICE/82 TOTOWA ROAD, WAYNE, NEW JERSEY 07470

FACTORY SERVICE CENTERS/NORTHEAST: 82 TOTOWA ROAD, WAYNE, NEW JERSEY 07470

MIDWEST: 1010 JOHNSON DRIVE, BUFFALO GROVE, ILLINOIS 60089-6900

WEST: 5490 E. FRANCIS ST., ONTARIO, CA 91761

SOUTHWEST: 1421 CHAMPION DRIVE, SUITE 304 CARROLLTON, TEXAS 75006

SOUTHEAST: 6115 JIMMY CARTER BLVD., SUITE C2, NORCROSS, GA 30071-4607

TOSHIBA HAWAII, INC.

HEAD OFFICE/327 KAMAKEE STREET, HONOLULU, HAWAII 96814, U.S.A.

TOSHIBA OF CANADA LTD.

HEAD OFFICE/191 McNABB STREET, MARKHAM, ONTARIO, L3R 8H2, CANADA TEL: (905) 470-5400

SERVICE CENTERS/TORONTO: 191 McNABB STREET, MARKHAM, ONTARIO, L3R 8H2, CANADA TEL: (905) 470-5400

MONTREAL: 1643, NORTH SERVICE RD., TRANS-CANADA HIGHWAY, DORVAL QUEBEC, H9P 1J1, CANADA

TEL: (514) 332-6860

VANCOUVER: 3870 JACOMBS ROAD, RICHMOND, B.C., V6V 1Y6, CANADA TEL: (604) 270-8481

MANUFACTURED BY

TOSHIBA AMERICA CONSUMER PRODUCTS, INC.

PRINTED IN USA

(96-08) L

TOSHIBA

23562853A