

**TOSHIBA**

# OWNER'S MANUAL

*COLOR TELEVISION*  
*CE27C10*



Thank you for purchasing a **TOSHIBA** Color Television Receiver.

Read this booklet so you will be able to enjoy all the features in your TV set and then retain for future reference.

Record in space provided below the Model No. and the Serial No. as found on the label on the back of your TV set.

Model No. \_\_\_\_\_

Serial No. \_\_\_\_\_

Retain this information for future reference.

## **SAFETY PRECAUTIONS**

### **WARNING :**

**TO REDUCE THE RISK OF FIRE OR ELECTRIC SHOCK, DO NOT EXPOSE THIS APPLIANCE TO RAIN OR MOISTURE.**



### **CAUTION**

**RISK OF ELECTRIC SHOCK  
DO NOT OPEN**



**CAUTION:** TO REDUCE THE RISK OF ELECTRIC SHOCK, DO NOT REMOVE COVER (OR BACK). NO USER-SERVICEABLE PARTS INSIDE. REFER SERVICING TO QUALIFIED SERVICE PERSONNEL.



THE LIGHTNING SYMBOL IN THE TRIANGLE TELLS YOU THAT THE VOLTAGE INSIDE THIS PRODUCT MAY BE STRONG ENOUGH TO CAUSE AN ELECTRIC SHOCK. DO NOT TRY TO SERVICE THIS PRODUCT YOURSELF.



THE EXCLAMATION POINT IN THE TRIANGLE TELLS YOU THAT IMPORTANT OPERATING AND MAINTENANCE INSTRUCTIONS FOLLOW THIS SYMBOL.

### **CAUTION :**

TO PREVENT ELECTRIC SHOCK, DO NOT USE THIS POLARIZED PLUG WITH AN EXTENSION CORD RECEPTACLE OR OTHER OUTLET UNLESS THE PRONGS CAN BE FULLY INSERTED INTO THE OUTLET TO PREVENT ANY EXPOSURE OF THE PRONGS ON THE POLARIZED PLUG.

### **CAUTION :**

This TV set may be used only with TOSHIBA stand model ST272. Use with other stands may result in instability causing possible injury.

# TABLE OF CONTENTS

---

## Set Up

Installing Your TV Set .....	4
Antenna/Cable TV General Information .....	4
Home Antenna Connection .....	5
Cable TV Connection .....	6
Antenna/Cable TV and VCR Connections .....	7

## Preparation

Location of Controls (TV set) .....	9
Location of Controls (Remote Control) .....	10
TV Channels .....	12
Programming Channel Memory .....	14
Introduction of On-Screen Menu .....	15

## Basic Operation

Watching TV Programs .....	16
Convenient Remote Functions .....	17

## Advanced Operation

Receiving a Stereo Program .....	18
Using the Off-Timer (Sleep) .....	19
Adjusting Picture and Audio .....	20
Closed Caption .....	22
On-Screen Demonstration .....	24

## Equipment Connections

Connecting Optional Equipment .....	25
-------------------------------------	----

## Reference Section

Maintenance and Care .....	26
Specifications .....	26
Before Calling Service Personnel .....	27
Limited Warranty .....	28

# INSTALLING YOUR TV SET

## DO NOT :

- Place your TV set in a room where direct lighting strikes the screen.
- Place your TV set too close to a wall, in a confined area or in a very warm location.
- Change the plug's safety prong. See note below.

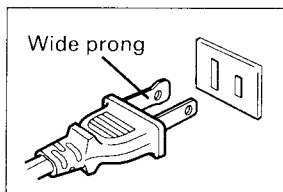

## Note:

As a safety feature, this plug has one prong wider than the other. It will fit only one way into a standard electrical outlet. If the plug will not fit into the outlet, try turning it around. If the plug will not fit either way, the outlet is probably old and nonstandard. You will need to have a new outlet installed by an electrician.

DO NOT CHANGE THIS SAFETY FEATURE OF THIS PLUG.

## DO :

- Use soft and indirect lighting.
- Sit at least 6 feet away from the set.
- Provide normal air circulation for reliable long life.
- Plug into an electrical outlet with standard house power. (120 volt AC, 60 Hz)

## ANTENNA/CABLE TV GENERAL INFORMATION

You can use either an indoor or outdoor antenna to receive VHF and/or UHF channels. Channels 2~13 are VHF channels, and channels 14~69 are UHF channels.

We recommend using an outdoor antenna for better picture quality.

You can receive Cable TV by connecting a cable supplied by your local cable company. Cable TV delivers both VHF and UHF channels and other channels not available from your antenna.

### TYPES OF ANTENNA CABLES

Shown below are two basic types of antenna cables. Signals from a home antenna may be conducted through either type. Cable TV signals will always be conducted through 75 ohm coaxial cable.

1. A 75 ohm system is generally a round cable with F-type connectors that can easily be attached to a terminal without tools.

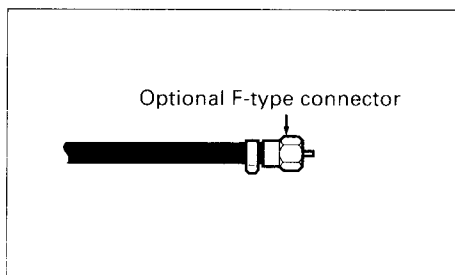

2. A 300 ohm system is a flat "twin-lead" cable that can be attached to a terminal through an antenna adapter supplied as an accessory.

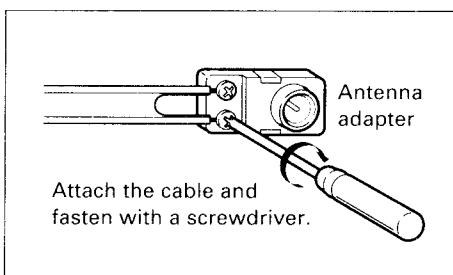

# HOME ANTENNA CONNECTION

## Connecting a single lead-in cable

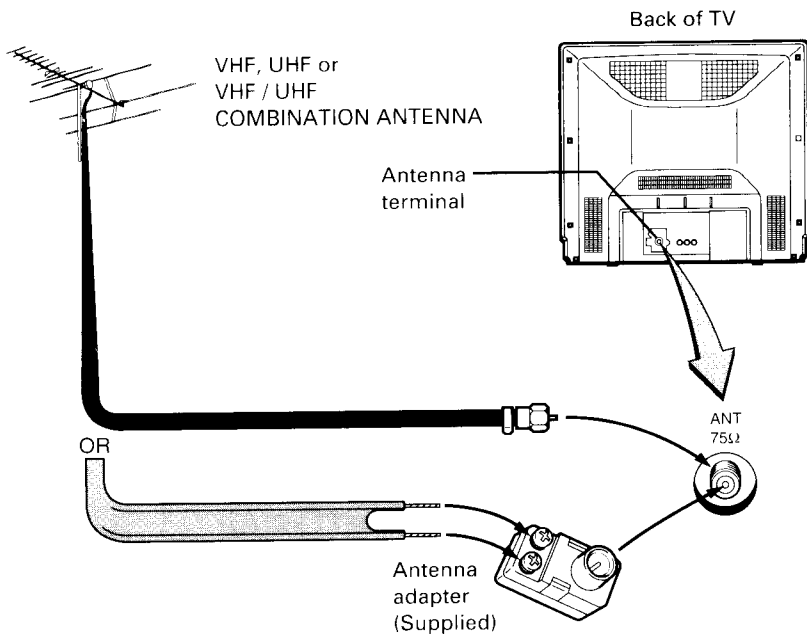

## Connecting both VHF and UHF lead-in cables

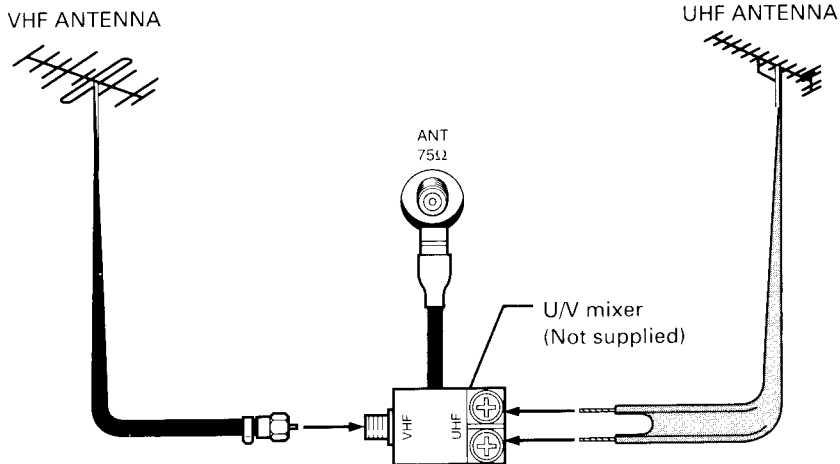

# CABLE TV CONNECTION

Generally, the incoming cable for a cable TV system can be connected directly to the TV antenna terminal just like a home antenna connection. Simply attach it to the ANT 75Ω terminal. You will be able to receive unscrambled cable channels.

## Cable without a decoder box (unscrambled channels)



Some cable companies offer "premium pay" channels in which the signal is scrambled. Descrambling these signals for normal viewing requires the use of a descrambler device which is generally provided by the cable company.

## Cable with a decoder box (scrambled channels)

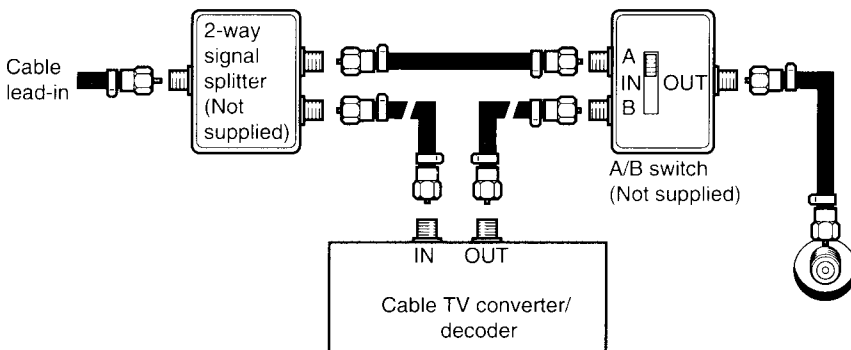

"A" position on the A/B switch allows you to select unscrambled channels using the TV's channel keys. "B" position allows you to select scrambled channels via the cable TV converter/decoder using the converter's channel keys. Place your TV on channel 3 or 4 to match the converter's output channel.

### Notes:

- The descrambler device may or may not be a part of the cable converter.
- Since cable systems vary, you may wish to consult your local cable company for additional information.

### NOTE TO CATV SYSTEM INSTALLER

This reminder is provided to call the CATV system installer's attention to Article 820-40 of the N.E.C., that provides guidelines for proper grounding and, in particular, specifies that the cable ground shall be connected to the grounding system of the building, as close to the point of cable entry as practical.

# ANTENNA/CABLE TV AND VCR CONNECTIONS

## VHF and/or UHF antenna connection via a VCR

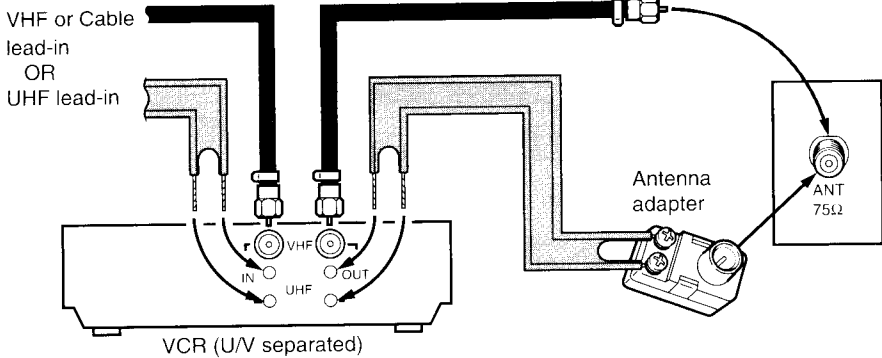

### Notes:

- On many VCR's, playback of tapes causes the TV/VCR switching to disconnect the antenna signals from the TV. If you cannot select a certain channel, try pressing the TV/VCR button on the remote control of the VCR.
- If you connect both VHF and UHF lead-in cables, use an optional U/V mixer. (See page 5.)

## Using a 2-set signal splitter

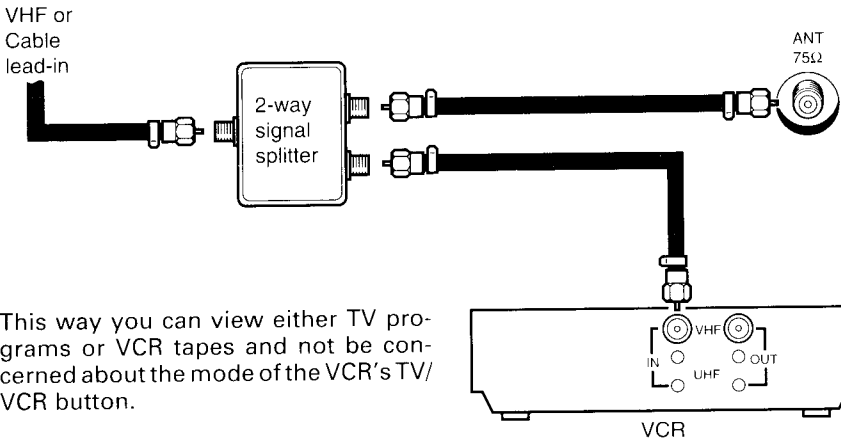

This way you can view either TV programs or VCR tapes and not be concerned about the mode of the VCR's TV/VCR button.

**Note:** When connected either way, the VIDEO/AUDIO connections from the VCR to the TV are required for stereo playback from VCR's. See page 25 for connection details.

# ANTENNA/CABLE TV AND VCR CONNECTIONS (Cont.)

## Cable with a decoder box

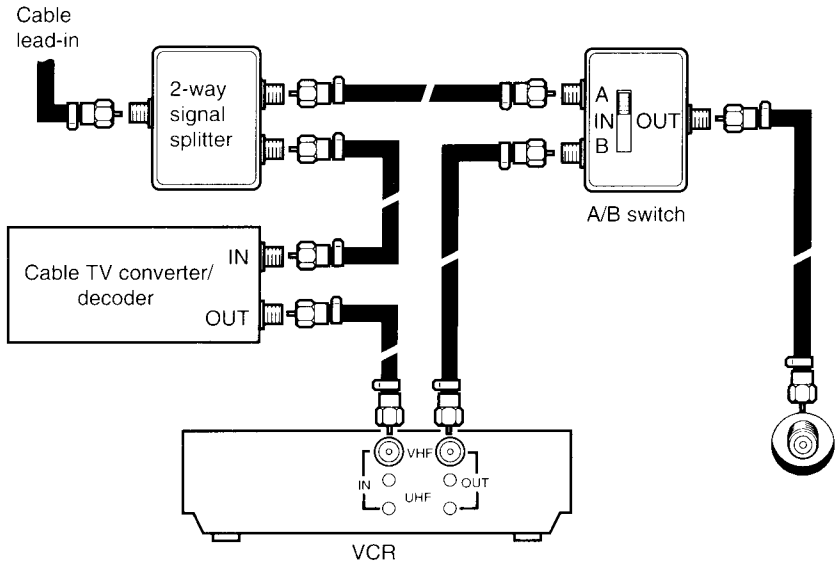

"A" position on the A/B switch allows you to select unscrambled channels using the TV's channel keys. "B" position on the A/B switch allows you to select scrambled channels via the cable TV converter/decoder using the converter's channel keys. Place your TV and VCR on channel 3 or 4 to match the converter's output channel.

**Note:** When connected this way, the VIDEO/AUDIO connections from the VCR to the TV are required for stereo playback from stereo VCR's. See page 25 for connection details.



# LOCATION OF CONTROLS (TV set)

For specific use of each control, consult the corresponding page numbers in brackets.

## FRONT VIEW

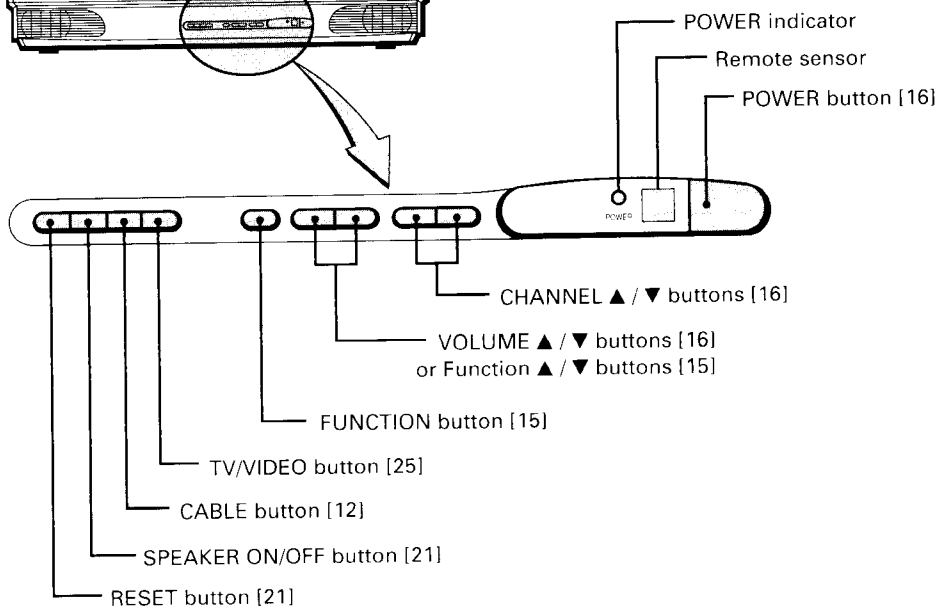
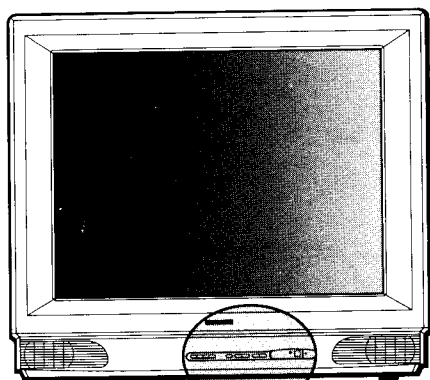

## REAR VIEW

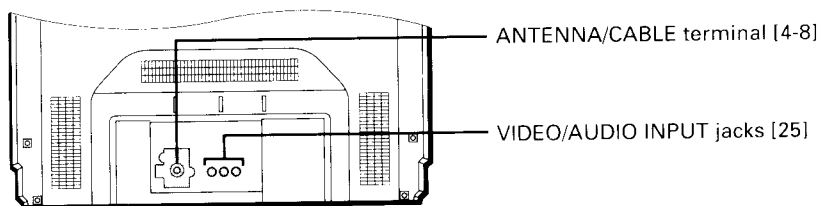

# LOCATION OF CONTROLS (Remote Control)

This Remote Control allows you to control the functions of your TV set from 16 feet (5m) away. The "\*" marked function buttons do not have duplicate locations on your TV set. They can be controlled only by the Remote Control. For specific use of each control, consult the corresponding page numbers in brackets.

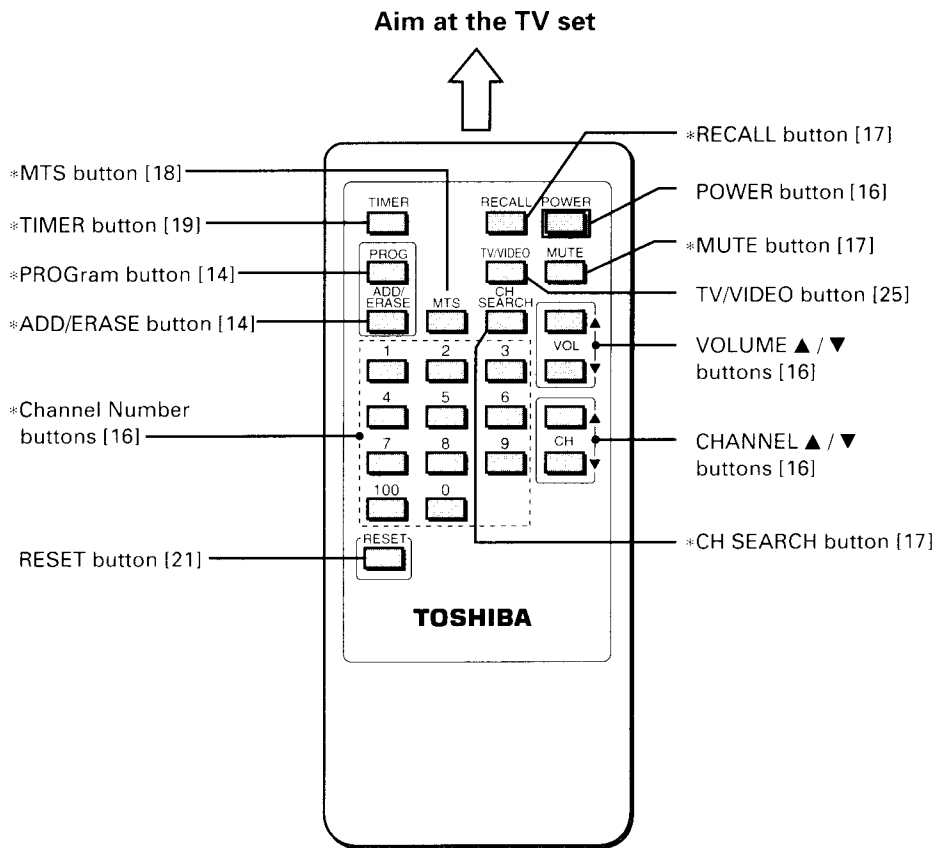

## BOTTOM VIEW

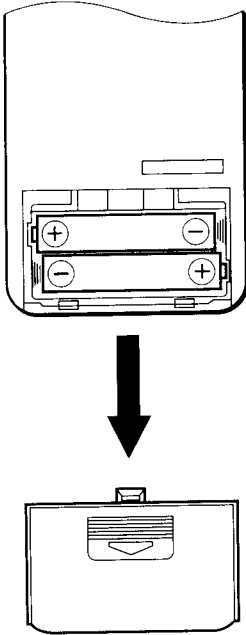

## INSTALL THE BATTERIES

1. Place the Remote Control with the face down, press down and slide to remove the battery cover.
2. Insert two "AAA" batteries, matching the + and - signs on each battery to the + and - signs in the Unit.
3. Replace the battery cover until the lock snaps.

## TIPS FOR BEST OPERATION

- Always aim your Remote Control directly at the TV set and be sure there is no obstruction between the Remote Control and the TV set.
- Do not drop, take apart or get your Remote Control wet.
- If you do not use your Remote Control for a long time or if the batteries are worn out, remove them from the Unit to prevent battery acid from leaking into the battery compartment.
- If your Remote Control does not always adjust the set as you wish, you probably need to replace the batteries.  
The life expectancy of the battery is about 1 year.

## CAUTION:

- Do not throw your batteries into a fire. Dispose of your batteries in a designated disposal area.
- Do not combine a used old battery with a new one.
- Do not mix battery types.

# TV CHANNELS

This TV will receive the following TV signals:

1. TV: Off the air TV signals. (VHF channels 2~13, UHF channels 14~69)
2. STD CABLE: Standard cable TV channels.
3. HRC CABLE: Harmonic Related Carrier cable TV signals.
4. IRC CABLE: Incremental Related Carrier cable TV signals.

For each of these systems, your TV set has exact frequencies built into it to ensure precise tuning. For precise tuning, your **CABLE** button must be set to match your TV signal system. The chart on the next page shows channels available in each system and how your TV displays them. When you connect your TV to a cable TV system and if you are not sure what system they are using, proceed with the following section "HOW TO FIND YOUR TYPE OF CABLE SYSTEM" or consult your local cable company to check if your system is STD, HRC or IRC.

## HOW TO FIND YOUR TYPE OF CABLE SYSTEM

1. Press **CABLE** to obtain the "STD CABLE" mode.
2. Select various channels and confirm whether the channels will lock immediately with perfect picture. If the channels seem to take a few seconds to lock in, your cable system may be one of the other cable systems. In this case, continue with the following steps.
3. Press **CABLE** to obtain the "HRC CABLE" mode and try above procedure again.
4. If you are having problems with only channel 5 or 6, you may have an IRC system so change the mode to "IRC CABLE".

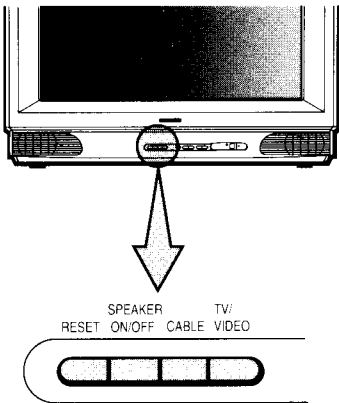

## CABLE BUTTON (on the TV set)

Each time you press **CABLE**, the TV/CABLE mode display changes:

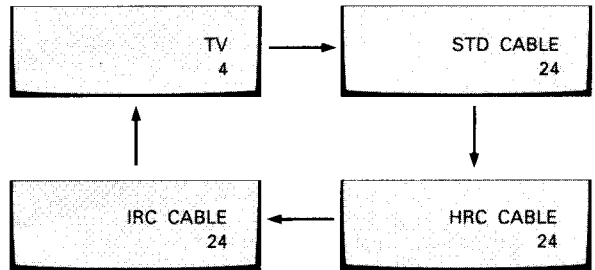

Press the button until your TV or cable system is selected.

**Note:** The Menu function can also be used to select this function. See page 15.

## TV/CABLE CHANNEL REFERENCE CHART

NUMBER ON THIS TV	CORRESPONDING CHANNEL NUMBER		NUMBER ON THIS TV	CORRESPONDING CHANNEL NUMBER	
	TV OFF THE AIR	CABLE STD/HRC/IRC		TV OFF THE AIR	CABLE STD/HRC/IRC
1	-	A-8	62	62	ZZ
2	2	2	63	63	AAA
3	3	3	64	64	BBB
4	4	4	65	65	65
5	5	5 (A-7)	66	66	66
6	6	6 (A-6)	67	67	67
7	7	7	68	68	68
8	8	8	69	69	69
9	9	9	70	Not used	70
10	10	10	71		71
11	11	11	⋮		⋮
12	12	12	⋮		⋮
13	13	13	93		93
14	14	A	94		94
15	15	B	95		A-5
16	16	C	96		A-4
⋮	⋮	⋮	97		A-3
⋮	⋮	⋮	98		A-2
35	35	V	99	A-1	
36	36	W	100	100	
37	37	AA	101	101	
38	38	BB	⋮	⋮	
⋮	⋮	⋮	⋮	⋮	
⋮	⋮	⋮	124	124	
61	61	YY	125	125	

**Note:** The above chart is typical of many cable system channel allocations. However, the numbering system may differ in your area. If in doubt, consult your cable company.

# PROGRAMMING CHANNEL MEMORY

Programming channels places available channels into memory so that your TV will stop on these channels when you press the **CHANNEL ▲** or **▼** button.

- The quickest way to program the channel memory is to use the **PROG** button.
- When it is decided that certain channels should be erased from the memory, the **ADD/ERASE** button provides complete programming flexibility.

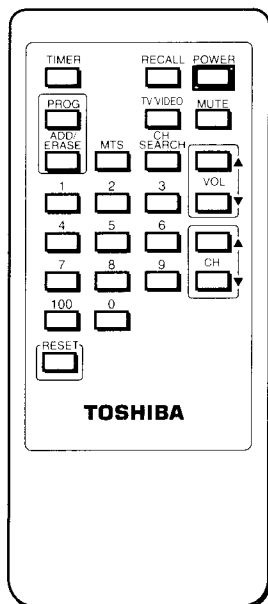

## AUTOPROGRAMMING CHANNELS

- 1 Press **POWER** to turn on the TV.
- 2 Make sure the **CABLE** button on the TV set is properly set.
- 3 Press **PROG** to start autoprogramming. The TV will automatically cycle through all channels and place active channels into the channel memory.
- 4 When the TV is finished cycling, you can check to see which channels are in memory by pressing **CH ▲ / ▼**.

## ADDING/ERASING CHANNELS

- 1 Press the **Channel Number** buttons or **CH ▲ / ▼** buttons to select the channel to be added or erased.

- 2 To add channels:  
Press **ADD/ERASE** until "ADDED" is displayed on the screen. This channel has now been added to the channel memory.



- To erase channels:  
Press **ADD/ERASE** until "ERASED" is displayed on the screen. This channel has now been erased from the channel memory.

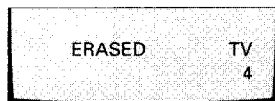

- 3 Repeat steps 1 and 2 for other channels.
- 4 Press **CH ▲** or **▼** to make sure the channels are programmed correctly.

# INTRODUCTION OF ON-SCREEN MENU

To adjust any TV feature, the use of the Menu function is required. Before beginning the adjustment or selection, we suggest you familiarize yourself with this procedure. The following chart shows all the menu pages displayed on the screen using the **FUNCTION** button and **Function ▲ / ▼** buttons on the TV. For the use of each control, refer to the pages in brackets.

## Picture menu

CONT BRIGHT SHARP  
COLOR TINT RESET

## Selection menu

TV/CABLE C. CAPT  
DEMONSTRATION

## Audio menu

TONE BALANCE  
SPEAKERS

Press **FUNCTION** to select item.

Press **Function ▲ / ▼** to adjust the item you have selected.

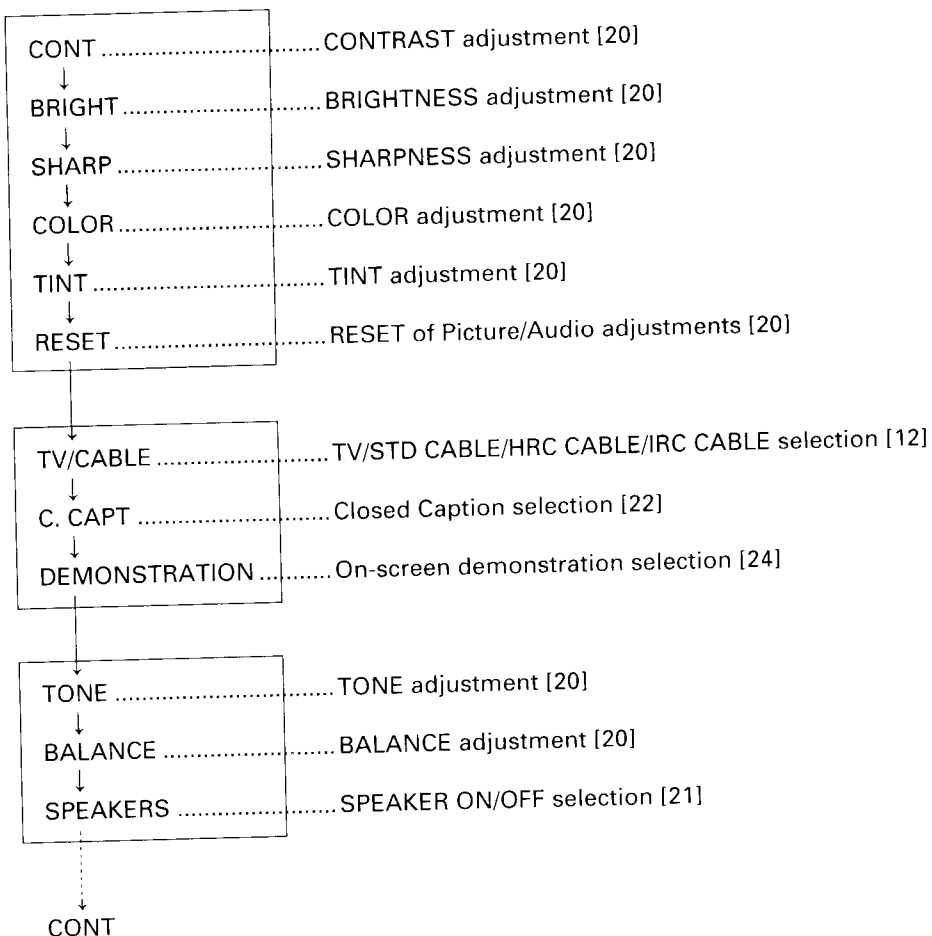

# WATCHING TV PROGRAMS

Generally, the Remote Control is all that is required to operate the TV.

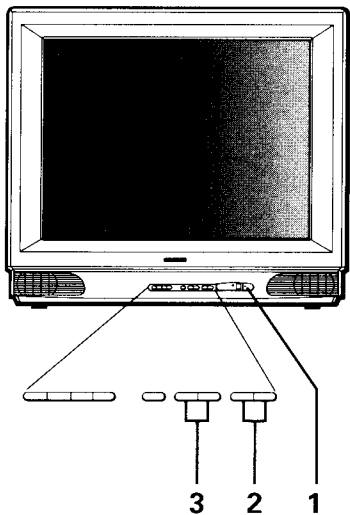

- 1 Press **POWER** to turn on the TV.  
To turn off the TV, press **POWER** again.

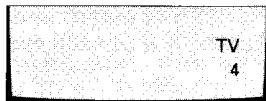

- 2 Select a channel in one of the following two ways.  
**To scan the memorized channels in numerical sequence**  
Press **CH (CHANNEL) ▲** to select next higher channel.  
Press **CH (CHANNEL) ▼** to select next lower channel.  
Press the button again to select next memorized channels.

### To select a channel directly

Press the **Channel Number** buttons (0~9 and 100).  
To select channel 4, press "4" (or press "0", "4").  
To select channel 38, press "3", "8".  
To select channel 125, press "100", "2", "5" in sequence.

- 3 Press **VOLUME ▲ / ▼** to adjust the volume.  
To increase the volume, press **▲**.  
To decrease the volume, press **▼**.

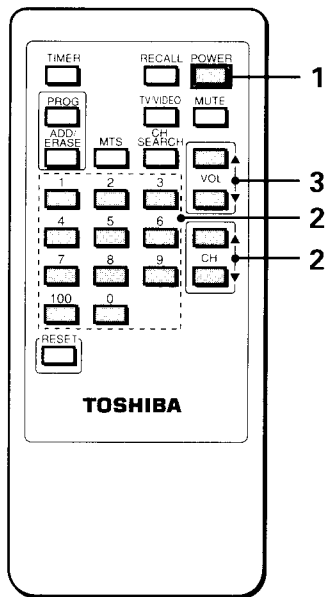
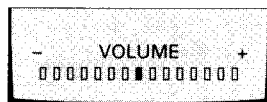

### Notes:

- If a vacant channel is tuned or TV broadcast for a day is finished, the TV will automatically turn off after about 15 minutes by the **Auto Power Off** feature. However, if the off-timer is operating, it takes precedence.
- The **VOLUME ▲/▼** buttons on the TV will function as the **Function ▲/▼** buttons while any of the menu displays are on the screen. See page 20.



# CONVENIENT REMOTE FUNCTIONS

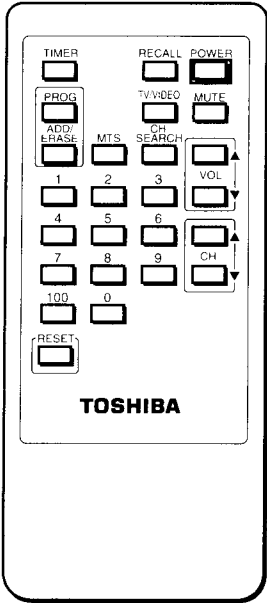

## SEARCHING FOR THE PROGRAM YOU WANT TO VIEW

Press **CH SEARCH** once to begin the channel search operation. The TV will automatically cycle through all channels as it will tune in the active channels for a moment each. Press **CH SEARCH** again while the program you want to view is on the screen. Searching will stop at its channel.

## CALLING UP THE ON-SCREEN INFORMATION

Press **RECALL** to display the channel number and the stereo audio status on the screen.

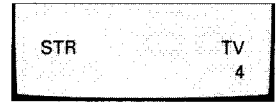

## MUTING THE SOUND

Press **MUTE** to mute the sound immediately without affecting the picture. This is useful during telephone calls or other interruptions.

To restore the sound, press **MUTE** again.

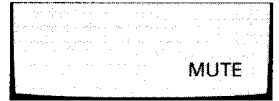

## RECEIVING A STEREO PROGRAM

The **MTS** button allows you to improve your TV viewing with high fidelity stereo sound.

See page 18 for details.

## USING THE OFF-TIMER

The **TIMER** button allows you to set the TV to turn off automatically after a certain period of time you set.

See page 19 for details.

# RECEIVING A STEREO PROGRAM

The Multi-channel TV Sound or MTS feature on this TV allows you to improve your TV viewing with high fidelity stereo sound.

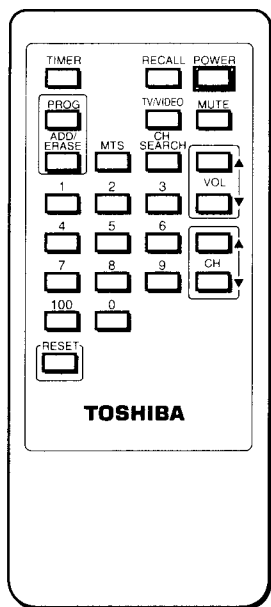

When the TV receives a stereo broadcast, the word "STR" is displayed on the screen whenever the TV is turned on, the channel is selected or the **RECALL** button is pressed.



You can then listen to the stereo sound by pressing the **MTS** button. Press the button until "STEREO" is displayed on the screen in red.

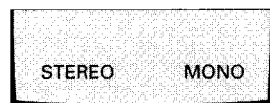

If a broadcasting signal is not strong enough and noise free stereo sound is not available, select "MONO".

The noise should be reduced.

**Note:** Please be sure you have selected the STEREO mode if broadcast is in stereo.

# USING THE OFF-TIMER (SLEEP)

This feature allows you to set the TV to turn itself off automatically after a certain period of time you set (every 10 minutes, up to 180 minutes or 3 hours). This is useful whenever you want to view TV for an hour or so before going to sleep.

## SETTING THE OFF-TIMER

Example: To set the off-timer to turn the TV set off after 150 minutes.

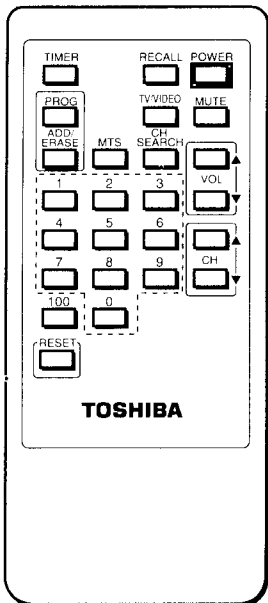

PROCEDURE	ON-SCREEN DISPLAY
<b>1</b> Press <b>TIMER</b> once to select the Timer mode.	OFF 00
<b>2</b> Press "1".	OFF 1 0
<b>3</b> Press "5".	OFF 15
<b>4</b> Press <b>TIMER</b> to start the timer. (The TV will begin to count down to zero.) The display color will change from red to green, and then the display will go off.	

### Notes:

- If you press **POWER** while the timer is operating, the timer setting will be cancelled.
- If you want to know the time remaining, press **TIMER**. Remaining time will be displayed on the screen. To erase the display, press the button again.
- You cannot select channels with the Remote Control if the Timer Display is on the screen.

# ADJUSTING PICTURE AND AUDIO

You can adjust the Picture or Audio functions to suit your personal preference.

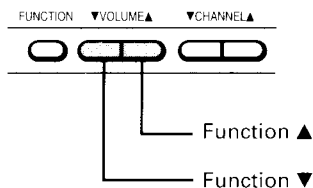
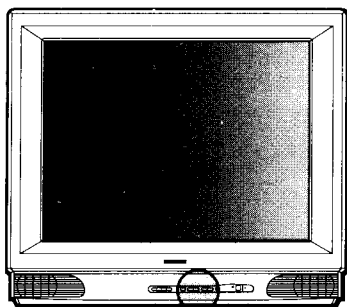

- 1 Press **FUNCTION** on the TV until the item you want to adjust is displayed on the screen in red.

Picture menu

CONT BRIGHT SHARP  
COLOR TINT RESET

Audio menu

TONE BALANCE  
SPEAKERS

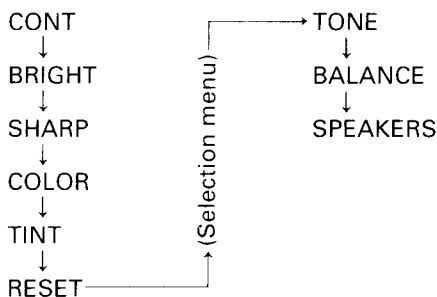

- 2 Press **Function ▲** or **▼** while the Picture or Audio menu is on the screen to adjust the item you have selected. Press and hold either button until your desired level is obtained.

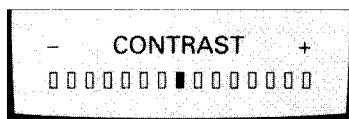

Decrease ◀                      ▶ Increase

- 3 Repeat steps 1 and 2 for other items.

**Note:** Enter each step within 6 seconds.

## EFFECT OF EACH FUNCTION

Item	Function ▼ button	Function ▲ button
CONTRAST	Low	High
BRIGHTNESS	Dark	Light
SHARPNESS	Soft	Sharp
COLOR	Pale	Deep
TINT	Skin tones become purplish	Skin tones become greenish
RESET	"RESET" appears on the screen and the settings are reset to the factory-preset levels. This is the same function as the RESET button shown below.	
TONE	Low	High
BALANCE	Lowers volume from the right speaker	Lowers volume from the left speaker
SPEAKERS	The built-in speakers are disconnected. This is the same function as the SPEAKER ON/OFF button on the TV shown below.	

### RESET BUTTON

You can restore all Picture and Audio functions to the factory-preset levels by one push of the **RESET** button on the TV or on the Remote Control.

Pressing the button will automatically set the **CONTRAST** to the maximum and all other functions (**BRIGHTNESS**, **SHARPNESS**, **COLOR**, **TINT**, **TONE** and **BALANCE**) at the center.

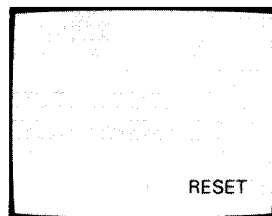

### SPEAKER ON/OFF BUTTON

Press **SPEAKER ON/OFF** until "SPEAKERS OFF" is displayed on the screen in red.

The built-in speakers are disconnected.

You will see the words "SPEAKERS OFF" on the screen for about 12 seconds whenever the TV is turned on.

To restore the sound, press the button to select "SPEAKERS ON".

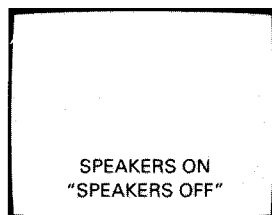

# CLOSED CAPTION

## CAPTION

Closed captioning displays dialogue, narration, and/or sound effects of a TV program on the screen in a manner similar to subtitles in a movie. Captioning is especially helpful for hearing impaired individuals. Captions will appear at either the top or bottom of the screen during caption broadcasts as shown below.

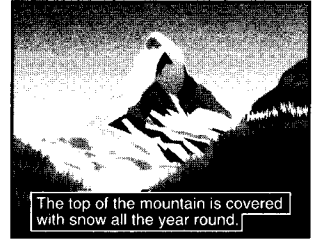

## TO DISPLAY CAPTIONS

- 1 Check your local TV listings for the time and channel number of captioned programs. Programs captioned are usually notated by its service marks such as "CC".
- 2 Press **FUNCTION** until "C. CAPT" is displayed on the screen in red.

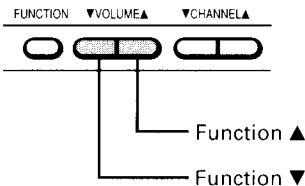
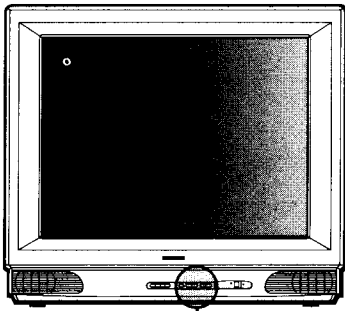

Selection menu

TV/CABLE "C. CAPT"  
DEMONSTRATION

**Note:** See page 15 for detailed Menu function.

- 3 Press **Function** ▲ or ▼ until "CAPT 1" or "CAPT 2" is displayed on the screen in red. The CAPT 2 mode may be utilized for alternate languages if they are being transmitted.

CAPT 1 CAPT 2 OFF  
TEXT 1 TEXT 2 OFF

The TV will display captions automatically if the program you are watching has been captioned.

If you do not want the caption displayed, select "OFF".

**Note:** The following situations may not be acceptable to decode the closed-captioned signal with this TV set.

- The video tape which was dubbed
- The weak signal reception
- The nonstandardized signal reception

## TEXT

Text is information that is displayed on the lower half of a TV screen. It is not related to the program on the TV screen. For example, it could be a listing of the closed-captioned programs, news, weather information or stock market reports.

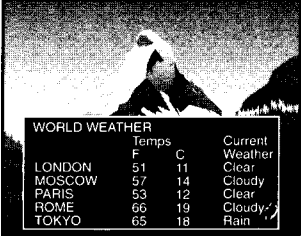

	Temps		Current Weather
	F	C	
LONDON	51	11	Clear
MOSCOW	57	14	Cloudy
PARIS	53	12	Clear
ROME	66	19	Cloudy
TOKYO	65	18	Rain

## TO DISPLAY TEXT INFORMATION

- 1 Press **FUNCTION** until "C. CAPT" is displayed on the screen in red.

Selection menu

TV/CABLE "C. CAPT"  
DEMONSTRATION

- 2 Press **Function** ▲ or ▼ until "TEXT 1" or "TEXT 2" is displayed on the screen in red.

CAPT 1 CAPT 2 OFF  
TEXT 1 TEXT 2 OFF

The TV displays TEXT information automatically if the program you are watching has text added.

If you do not want to display the TEXT information, select "OFF".

**Note:** If you select a Caption format channel and the "TEXT" mode, the TEXT (black) screen will always be displayed. However, if the TEXT character signal is not transmitted, the characters are not displayed.

This TV receiver provides display of television closed captioning in accordance with 15.119 of the FCC rules.

This TV receiver supports 5 (except Blue and Magenta) of 7 color attributes.

# ON-SCREEN DEMONSTRATION

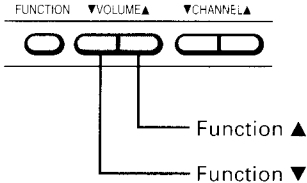
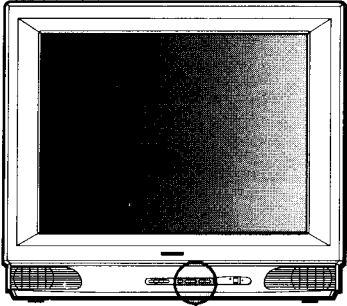

When this function is activated, your TV will automatically display a variety of its on-screen menus and special features. This function is provided for the Toshiba dealer. You may not need to use this function.

- 1 Press the **FUNCTION** button until "DEMONSTRATION" is displayed on the screen in red.

Selection menu

TV/CABLE C. CAPT  
"DEMONSTRATION"

- 2 Press the **Function ▲** or **▼** button until "DEMO START" is displayed on the screen in red.

"DEMO START"  
DEMO STOP

The on-screen demonstration will start after about 6 seconds.

To stop the demonstration, select "DEMO STOP".

**Note:** The on-screen demonstration will continue even if the TV is turned off. And to turn the on-screen demonstration off, follow the instructions listed above.



# CONNECTING OPTIONAL EQUIPMENT

You can connect optional video equipment to this TV such as VCR or video disc player.

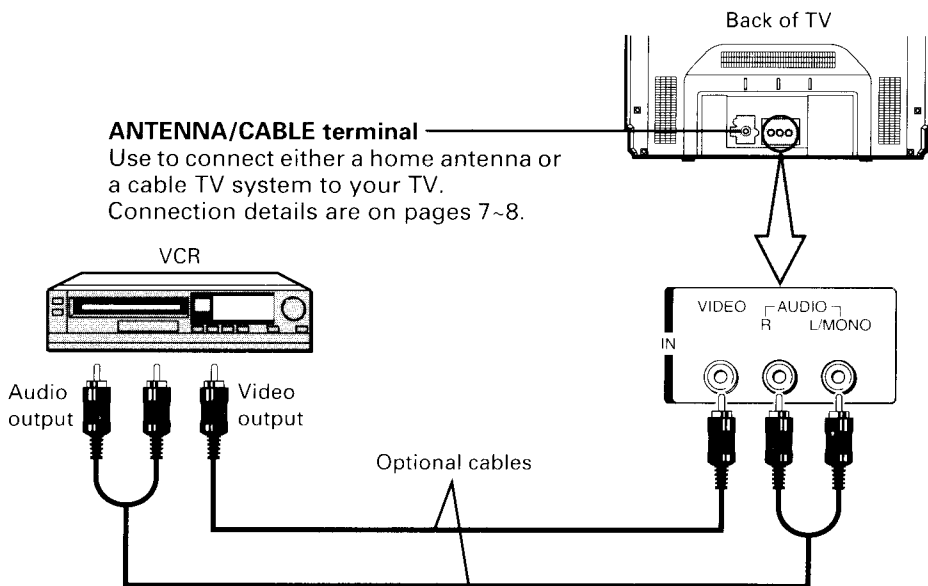

## SELECTING VIDEO SOURCES

To operate your TV and VIDEO equipment properly refer to the instructions furnished with the VIDEO equipment.

- 1 Turn the TV set and VCR ON.
- 2 Press **TV/VIDEO** to select "VIDEO" mode.

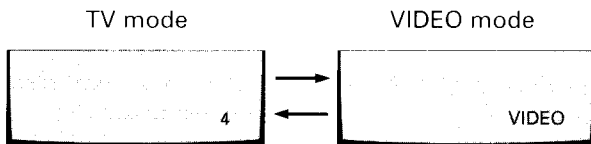

- 3 Operate your VCR normally.

**Note:** If you connect a monaural VCR, connect the audio output of the VCR to the L/MONO jack on the TV set.

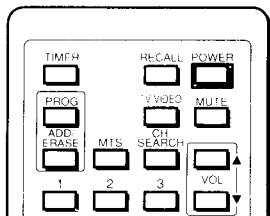
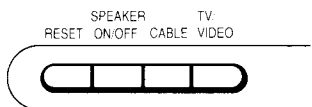

# MAINTENANCE AND CARE

---

**WARNING:** TV sets use High Voltages. Do not try to remove the cabinet back. Refer servicing to qualified service personnel.

- To clean the TV screen:
  1. First remove the plug from the power outlet.
  2. Use a clean cellulose sponge or chamois cloth dampened with a solution of mild detergent and warm water to clean TV screen and trim. Do not use too much water on the TV screen.
  3. Remove any extra moisture with the same cloth or a dry one.
- To maintain the finish and appearance of the cabinet, polish it from time to time with a quality furniture polish.

## SPECIFICATIONS

---

TELEVISION SYSTEM:	NTSC standard
CHANNEL COVERAGE:	VHF; 2 through 13 UHF; 14 through 69 Cable TV; mid band (A-8 through A-1, A through I) super band (J through W) hyper band (AA through ZZ, AAA, BBB) ultra band (65 through 94, 100 through 125)
POWER SOURCE:	120 V AC, 60 Hz
POWER CONSUMPTION:	86 W (average)
AUDIO POWER:	3 W + 3 W
VIDEO/AUDIO TERMINALS:	VIDEO INPUT: 1 Vp-p, 75 ohm, negative sync. AUDIO INPUT: 150 mVrms. (30% modulation 47k ohm)
DIMENSIONS:	Width ..... 27-23/64 inches (695 mm) Height ..... 23-13/16 inches (605 mm) Depth ..... 19-17/32 inches (496 mm)
WEIGHT:	77 lbs (34.9 kg)
SUPPLIED ACCESSORIES:	Remote Control with 2 size "AAA" batteries Antenna adapter

Design and specifications are subject to change without notice.

# **BEFORE CALLING SERVICE PERSONNEL**

Before calling service personnel, please check the following chart for a possible cause of the problem you are experiencing. A minor adjustment on your part may eliminate the problem and restore your TV reception.

<b>Symptoms</b>	<b>Check these things</b>	<b>Try these adjustments</b>
<ul style="list-style-type: none"> <li>• No picture, no sound</li> </ul>	<ul style="list-style-type: none"> <li>• Be sure power cord is plugged in.</li> <li>• May be station trouble.</li> <li>• Check antenna connections.</li> <li>• Check antenna for broken wires.</li> </ul>	<ul style="list-style-type: none"> <li>• Press POWER button.</li> <li>• Try another channel.</li> </ul>
<ul style="list-style-type: none"> <li>• No UHF, VHF OK</li> </ul>	<ul style="list-style-type: none"> <li>• Check if CABLE button is properly set.</li> </ul>	
<ul style="list-style-type: none"> <li>• No sound, picture OK</li> </ul>	<ul style="list-style-type: none"> <li>• May be station trouble.</li> <li>• Be sure SPEAKER ON/OFF button is "ON" mode.</li> </ul>	<ul style="list-style-type: none"> <li>• Try another channel.</li> <li>• Adjust VOLUME control.</li> </ul>
<ul style="list-style-type: none"> <li>• Poor sound, picture OK</li> </ul>	<ul style="list-style-type: none"> <li>• May be station trouble.</li> <li>• Check antenna connections.</li> <li>• May be local interference from appliance.</li> </ul>	<ul style="list-style-type: none"> <li>• Try another channel.</li> <li>• Adjust VOLUME control.</li> <li>• Adjust TONE, or BALANCE control.</li> <li>• Re-orient antenna.</li> </ul>
<ul style="list-style-type: none"> <li>• Poor picture, sound OK</li> <li>• Snowy picture</li> <li>• Lines in picture</li> <li>• Distorted picture</li> <li>• Weak picture</li> </ul>	<ul style="list-style-type: none"> <li>• May be local interference from appliance.</li> <li>• Check antenna connections.</li> <li>• Check antenna for broken wires.</li> <li>• May be station trouble.</li> </ul>	<ul style="list-style-type: none"> <li>• Try another channel.</li> <li>• Adjust BRIGHTNESS control.</li> <li>• Adjust CONTRAST control.</li> <li>• Adjust SHARPNESS control.</li> <li>• Re-orient antenna.</li> </ul>
<ul style="list-style-type: none"> <li>• Multiple images (ghosts)</li> </ul>	<ul style="list-style-type: none"> <li>• May be station trouble.</li> <li>• Check antenna connections.</li> </ul>	<ul style="list-style-type: none"> <li>• Try another channel.</li> <li>• Re-orient antenna.</li> </ul>
<ul style="list-style-type: none"> <li>• Poor color or No color</li> </ul>	<ul style="list-style-type: none"> <li>• May be station trouble.</li> <li>• Check antenna connections.</li> <li>• Check antenna for broken wires.</li> <li>• May be local interference from appliance.</li> <li>• Check if station is broadcasting in color.</li> </ul>	<ul style="list-style-type: none"> <li>• Try another channel.</li> <li>• Re-orient antenna.</li> <li>• Adjust TINT control.</li> <li>• Adjust COLOR control.</li> </ul>
<ul style="list-style-type: none"> <li>• Black screen appears on the screen.</li> </ul>	<ul style="list-style-type: none"> <li>• Check if CLOSED CAPTION function is in "OFF" mode.</li> </ul>	
<ul style="list-style-type: none"> <li>• Weak and noisy stereo program</li> </ul>	<ul style="list-style-type: none"> <li>• Check antenna connections.</li> <li>• Check antenna for broken wires.</li> </ul>	<ul style="list-style-type: none"> <li>• Re-orient antenna.</li> <li>• Try pressing MTS button in "MONO" mode.</li> </ul>
<ul style="list-style-type: none"> <li>• No stereo sound from a known stereo broadcast</li> </ul>	<ul style="list-style-type: none"> <li>• Be sure MTS button is in "STEREO" mode.</li> </ul>	
<ul style="list-style-type: none"> <li>• Remote Control does not work</li> </ul>	<ul style="list-style-type: none"> <li>• Be sure power cord is plugged in.</li> <li>• Check battery in Remote Control.</li> </ul>	<ul style="list-style-type: none"> <li>• Change batteries.</li> </ul>

# LIMITED WARRANTY

Toshiba America Consumer Products, Inc. ("TACP") and Toshiba Hawaii Inc. ("THI") make the following limited warranties. These limited warranties extend to the original consumer purchaser or any person receiving this set as a gift from the original consumer purchaser and to no other purchaser or transferee.

## Limited One (1) Year Warranty

TACP and THI warrant this product and its parts against defects in materials or workmanship for a period of one (1) year after the date of original retail purchase. During this period, TACP and THI will repair a defective product or part, without charge to you. Service on this product will be made available to you in your home.

## Limited Two (2) Year Warranty of Picture Tube

TACP and THI further warrant the picture tube in this product against defects in materials or workmanship for a period of two (2) years after the date of original retail purchase. During this period, TACP and THI will replace a defective picture tube without charge to you, except that if a defective picture tube is replaced after one (1) year from the date of the original retail purchase, you pay labor charges involved in the replacement.

## Owner's Manual and Registration Card

You should read this owner's manual thoroughly before operating this product. You should also insure that your name and address are on file as owner's of a TACP/THI product by completing and mailing the enclosed registration card within ten days after you, or the person who has given you this product as a gift, purchased this product. This is one way to enable TACP/THI to provide you with better customer service and improved products. Failure to return the card will not affect

your rights under this warranty so long as you retain other proof of purchase such as a bill of sale.

## Your Responsibility

- The above warranties are subject to the following conditions:
- (1) You must retain your bill of sale or provide other proof of purchase.
  - (2) All warranty servicing of this product must be made by an Authorized TACP/THI Service Station.
  - (3) These warranties are effective only if the product is purchased and operated in the U.S.A.
  - (4) Labor service charges for set installation, set up, adjustment of customer controls and installation or repair of antenna systems are not covered by this warranty. Reception problems caused by inadequate antenna systems are your responsibility.
  - (5) Warranties extend only to defects in materials or workmanship as limited above and do not extend to any product or parts which have been lost or discarded by you or to damage to products or parts caused by misuse, accident, improper installation, improper maintenance or use in violation of instructions furnished by us; or no units which have been altered or modified without authorization of TACP/THI or to damage to products or parts thereof which have had the serial number removed, altered, defaced or rendered illegible.

## Step-By-Step Procedures – How to Obtain Warranty Service

If after following all of the operating instructions in this manual and checking the section "BEFORE CALLING SERVICE PERSONNEL", you find that service is needed;

- (1) Contact one of the TACP/THI Service Centers listed below for warranty service or call the TACP toll free number **800-631-3811** within thirty (30) days after you find a defective product or part to find the nearest TOSHIBA Authorized Service Station or authorized TOSHIBA dealer.
- (2) Please present your bill of sale or other proof to the Authorized Service Station. Service on this product will be made available to you in your home.
- (3) If you have any question about service, please contact one of the following TACP/THI Service Centers:

IN THE CONTINENTAL UNITED STATES  
Should your unit require service, Call



NORTHEAST	MIDWEST	WEST	SOUTHEAST	SOUTHWEST	HAWAII
82 Totowa Road, Wayne, New Jersey 07470	1010 Johnson Drive, Buffalo Grove, Ill 60089-6900	5490 E. Francis St., Ontario, California 91761	6115 Jimmy Carter Blvd., Suite C2, Norcross, Georgia 30071-4607	1421 Champion Drive Suite 304, Carrollton, Texas 75006	327 Kamakee Street, Honolulu, Hawaii 96814

**ALL WARRANTIES IMPLIED BY STATE LAW, INCLUDING THE IMPLIED WARRANTIES OF MERCHANTABILITY AND FITNESS FOR A PARTICULAR PURPOSE, ARE EXPRESSLY LIMITED TO THE DURATION OF THE LIMITED WARRANTIES SET FORTH ABOVE.** Some states do not allow limitations on how long an implied warranty lasts, so the above limitation may not apply to you. **WITH THE EXCEPTION OF ANY WARRANTIES IMPLIED BY STATE LAW AS HEREBY LIMITED, THE FOREGOING EXPRESS WARRANTY IS EXCLUSIVE AND IN LIEU OF ALL OTHER WARRANTIES, GUARANTEES, AGREEMENTS AND SIMILAR OBLIGATIONS OF MANUFACTURER OR SELLER WITH RESPECT TO THE REPAIR OR REPLACEMENT OF ANY PRODUCT OR PARTS.**

**IN NO EVENT SHALL TACP OR THI BE LIABLE FOR CONSEQUENTIAL OR INCIDENTAL DAMAGES.** Some states do not allow the exclusion or limitation of incidental or consequential damages so the above limitation may not apply to you.

No person, agent, distributor, dealer, service station or company is authorized to change, modify or extend the terms of these warranties in any manner whatsoever. The time within which an action must be commenced to enforce any obligation of TACP and THI arising under this warranty or under any statute, or law of the United States or any state thereof is hereby limited to one year from the date you discover or should have discovered, the defect. This limitation does not apply to implied warranties arising under state law. Some states do not permit limitation of the time within which you may bring an action beyond the limits provided by state law so the above provision may not apply to you. This warranty gives you specific legal rights and you may also have other rights which vary from state to state.

## **TOSHIBA AMERICA CONSUMER PRODUCTS, INC.**

HEAD OFFICE/82 TOTOWA ROAD, WAYNE, NEW JERSEY 07470 PHONE : (201) 628-8000

FACTORY SERVICE CENTERS/NORTHEAST : 82 TOTOWA ROAD, WAYNE, NEW JERSEY 07470

PHONE : (201) 628-8000

MIDWEST : 1010 JOHNSON DRIVE, BUFFALO GROVE, ILLINOIS 60089-6900

PHONE : (708) 541-9400

WEST : 5490 E. FRANCIS ST., ONTARIO, CA 91761

PHONE : (909) 988-5303

SOUTHWEST : 1421 CHAMPION DRIVE, SUITE 304 CARROLLTON, TEXAS 75006

PHONE : (214) 243-1367

SOUTHEAST : 6115 JIMMY CARTER BLVD., SUITE C2, NORCROSS, GEORGIA 30071-4607

PHONE : (404) 242-7500

## **TOSHIBA HAWAII, INC.**

HEAD OFFICE/327 KAMAKEE STREET, HONOLULU, HAWAII 96814, U.S.A. PHONE : (808) 521-5377

MANUFACTURED BY

**TOSHIBA AMERICA CONSUMER PRODUCTS, INC.**

PRINTED IN USA

(93-05)

# **TOSHIBA**

23561854