

LAVAMAT 72950 - 74950



User Manual

Washing Machine

PERFEKT IN FORM UND FUNKTION

AEG

 Electrolux

Dear Customer

Thank you for choosing one of our high-quality products.

With this appliance you will experience the perfect combination of functional design and cutting edge technology.

Convince yourself that our appliances are engineered to deliver the best performance and control - indeed we are setting the highest standards of excellence.

In addition to this you find environmental and energy saving aspects as an integral part of our products.

To ensure optimal and regular performance of your appliance please read this instruction manual carefully. It will enable you to navigate all processes perfectly and most efficiently. To refer to this manual any time you need to, we recommend you to keep it in a safe place. And please pass it to any future owner of the appliance.

We wish you much joy with your new appliance.

The following symbols are used in this manual:



Important information concerning your personal safety and information on how to avoid damaging the appliance



General information and tips



Environmental information

Contents

Safety information	6
Product Description	10
Detergent dispenser drawer	10
Control panel	11
Display	12
First use	13
Personalization	14
Acoustic signal	14
Child safety lock	14
Daily use	15
Load the laundry	15
Measure out the detergent and the fabric softener	15
Select the required programme by means of programme selector dial	16
Select the temperature	16
Select the Spin speed, Rinse Hold or Night Cycle option	16
Selected the desired option	17
Prewash option	17
Stain option	18
Sensitive option	18
Select an additional rinse	18
Time Saving option	18
Select the Start/Pause	19
Select the Delay Start	19
Altering an option or a running programme	20
Interrupting a programme	20
Cancelling a programme	20

Opening the door after the programme has started	20
At the end of the programme	21
Washing programmes	22-25
<hr/>	
Programme information	26-27
<hr/>	
Washing hints	28
<hr/>	
Sorting the laundry	28
Temperatures	28
Before loading the laundry	28
Maximum loads	29
Laundry weights	29
Removing stains	30
Detergents and additives	30
Quantity of detergent to be used	31
Degrees of water hardness	31
International wash code symbols	33
<hr/>	
Care and cleaning	34
<hr/>	
Descaling	34
After each wash	34
External cleaning	34
Detergent dispenser drawer	34
Drain pump	35
Water inlet filter	36
Frost precautions	37
Emergency emptying out	37
Something not working	38
<hr/>	
Technical Data	42
<hr/>	
Consumption value	43

Installation	44
Unpacking	44
Positioning and levelling	46
Water inlet	46
Water-stop device	47
Water drainage	47
Electrical connection	48
Environment concerns	49
Packaging materials	49
Old machine	49
Ecological hints	49
Guarantee	50
Customer service centres	52

Safety information

Prior to using for the first time

- The safety of AEG/ELECTROLUX appliances complies with the industry standards and with legal requirements on the safety of appliances. However, as manufacturers, we feel it is our duty to provide the following safety notes. You **MUST** read them carefully before installing or using the appliance.
- It is most important that this instruction book should be retained with the appliance for future reference. Should the appliance be sold or transferred to another owner, or should you move house and leave the appliance, always ensure that the book is supplied with the appliance in order that the new owner can get to know the functioning of the appliance and the relevant warnings.
- You **MUST** read them carefully before installing or using the appliance.
- Before first starting up, check the machine for any damage incurred during transport. Never connect up a damaged machine. If parts are damaged, contact your supplier.
- If the appliance is delivered in the winter months when there are minus temperatures: Store the washing machine at room temperature for 24 hours before using for the first time.

General safety

- It is dangerous to alter the specifications or attempt to modify this product in any way.
- During high temperature wash programmes the door glass may get hot. Do not touch it!
- Make sure that small pets do not climb into the drum. To avoid this, please check into the drum before using.
- Any objects such as coins, safety pins, nails, screws, stones or any other hard, sharp material can cause extensive damage and must not be placed into the machine.
- Only use the advised quantities of fabric softener and detergent. Damage to the fabric can ensue if you over-fill. Refer to the manufacturer's recommendations of quantities.
- Wash small items such as socks, laces, washable belts etc in a washing bag or pillow case as it is possible for such items to slip down between the tub and the inner drum.

- Do not use your washing machine to wash articles with whalebones, material without hems or torn material.
- Always unplug the appliance and turn off the water supply after use, clean and maintenance.
- This appliance is provided with a white drum light. It is class 1, in accordance with IEC 60825-1:1993 + A1:1997 + A2:2001 standard. Should the appliance drum light need to be replaced, this must be carried out by a Service Centre.
- Under no circumstances should you attempt to repair the machine yourself. Repairs carried out by inexperienced persons may cause injury or serious malfunctioning. Contact your local Service Centre. Always insist on genuine spare parts.

Installation

- When unpacking the appliance, check that it is not damaged. If in doubt, do not use it and contact the Service Centre.
- All packing and transit bolts must be removed before use. Serious damage can occur to the product and to property if this is not adhered to. See relevant section in the user manual.
- After having installed the appliance, check that it is not pressing or standing on its electrical supply cable, inlet hose and drain hose.
- If the machine is situated on a carpeted floor, please adjust the feet in order to allow air to circulate freely
- Always be sure, that there is no water leakage from hoses and their connections after the installation.
- If the appliance is installed in a location subject to frost, please read the "**dangers of freezing**" chapter.
- Any plumbing work required to install this appliance should be carried out by a qualified plumber or competent person.
- Any electrical work required to install this appliance should be carried out by a qualified electrician or competent person.

Use

- This appliance is designed for domestic use. It must not be used for purposes other than those for which it was designed.
- Only wash fabrics which are designed to be machine washed. Follow the instructions on each garment label.
- Do not overload the appliance. See the relevant section in the user manual.
- Before washing, ensure that all pockets are empty and buttons and zips are fastened. Avoid washing frayed or torn articles and treat stains such as paint, ink, rust, and grass before washing. Underwired bras must NOT be machine washed.
- Garments which have been in contact with volatile petroleum products should not be machine washed. If volatile cleaning fluids are used, care should be taken to ensure that the fluid is removed from the garment before placing in the machine.
- Never pull the power supply cable to remove the plug from the socket; always take hold of the plug itself.
- Never use the washing machine if the power supply cable, the control panel, the working surface or the base are damaged so that the inside of the washing machine is accessible.

Child Safety

- This appliance is not intended for use by person (including children) with reduced physical sensory or mental capabilities or lack of experience and knowledge unless they have been given supervision or instruction concerning use of the appliance by a person responsible for their safety.
- This washing machine is not intended for use by young children or infirm persons without supervision.
- Young children should be supervised to ensure that they do not play with the appliance.
- The packaging components (e.g. plastic film, polystyrene) can be dangerous to children - danger of suffocation! Keep them out of children's reach.
- Keep all detergents in a safe place out of children's reach.

- Make sure that children or pets do not climb into the drum. To avoid this the machine incorporates special feature. To activate this device, rotate the button (without pressing it) inside the door clockwise until the groove is horizontal. If necessary use a coin. To disable this device and restore the possibility of closing the door, rotate the button anti-clockwise until the groove is vertical.

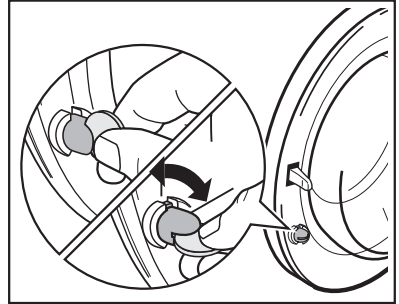

Product description



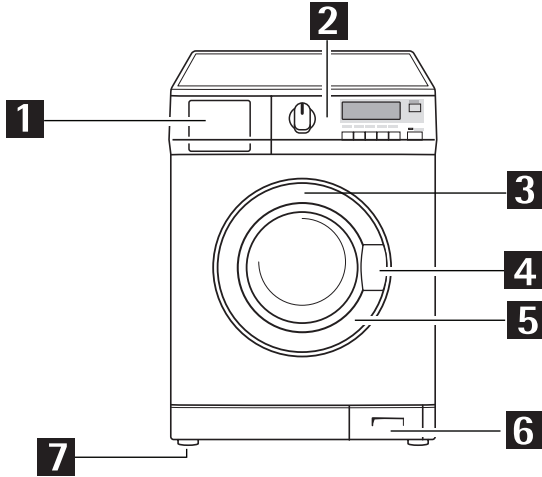

Your new appliance meets all modern requirements for effective treatment of laundry with low water, energy and detergent consumption.

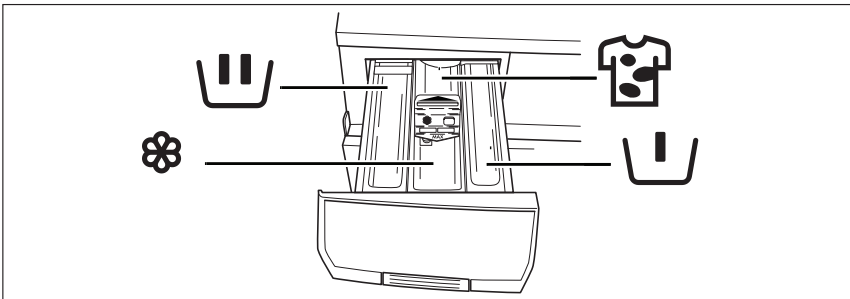

- | | | | |
|----------|----------------------------|----------|---|
| 1 | Detergent dispenser drawer | 5 | Rating plate |
| 2 | Control panel | 6 | Drain pump |
| 3 | Drum light | 7 | Three adjustable feet; The rear foot on the left-hand side is automatic |
| 4 | Door opening handle | | |

Detergent dispenser drawer



-  Compartment for **prewash phase** used for **prewash**
-  Compartment for powder or liquid detergent used for **main wash**.
-  Compartment for **liquid additives** (fabric softener, starch).
-  Compartment for stain remover used for main wash with **STAIN - option**.

Control panel



Henceforth the programme selector dial, the buttons and the display will be indicated with the numbers given in this table.

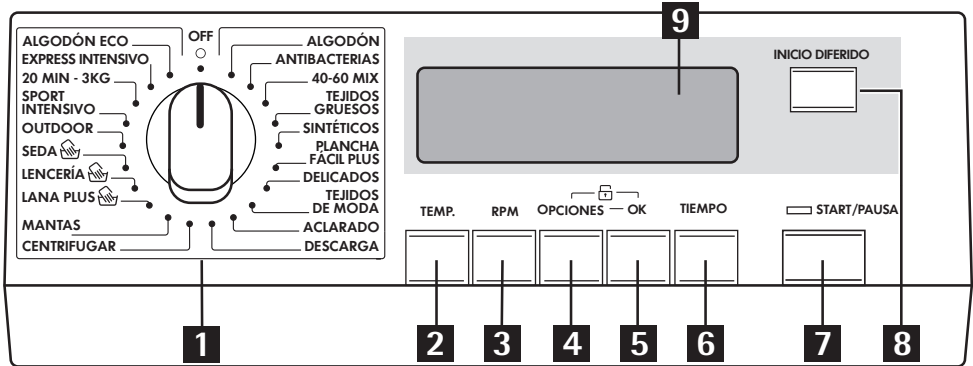



- 1** Programme selector dial
- 2** TEMPERATURE button
- 3** SPIN REDUCTION button
- 4** OPTIONS button
- 5** OK button



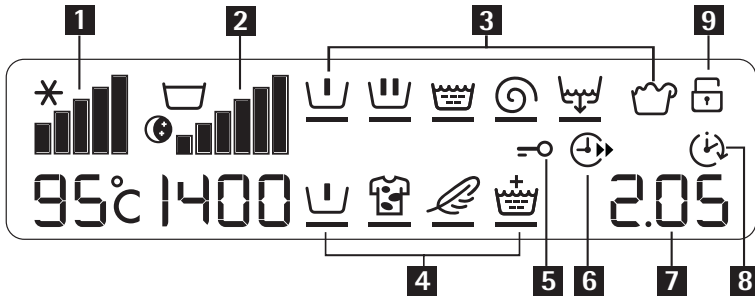

- 6** TIME SAVING button
- 7** START/PAUSE button
- 8** DELAY START button
- 9** Display

Display (9)



9.1 Temperature - symbol

9.2 Spin Speed, Rinse Hold , Night Cycle  - symbols

9.3 Programme progress display: PREWASH , MAIN WASH , RINSE , SPIN , DRAIN , OVERDOSAGE 

The programme progress display shows the washing phases of the selected programme.

During a washing cycle, a black line flashes under the washing phase symbol of the running programme. At the end of each washing phase, the line under the corresponding symbol becomes fixed.



If the symbol OVERDOSAGE lights up at the end of the programme, it indicates that too much detergent has been used.

9.4 Options: PREWASH , STAIN , SENSITIVE , EXTRA RINSE 

9.5 DOOR  - symbol (Door locked)

This symbol indicates if the door can be opened:

- the symbol is on: the door cannot be opened. The appliance is performing a washing programme.
- the is off: the door can be opened. The washing programme is finished.

9.6 TIME SAVING  - option symbol

9.7 The display shows the following information:

Duration of the selected programme

After selecting a programme, the duration is displayed in hours and minutes (for example **2.05**). The duration is calculated automatically on the basis of the maximum recommended load for each type of fabric.

After the programme has started, the time remaining is updated every minute.

Delay start

The selected delay (20 hours max) set by means of the relevant button appears on the display for about 3 seconds (for example **90'**), then the duration of the previously selected programme is displayed.

The DELAY START symbol will appear on the display.

The delay time value decreases by one unit every hour and then, when remains 1 hour, the time decreases every minute.

Incorrect option selection

If an option which is not compatible with the set wash programme is selected, the message **Err** is displayed for about 2 seconds and the yellow light of button **7** starts flashing.

Alarm codes

In the event of operating problems, some alarm codes can be displayed, for example **E20** (see paragraph «Something not working»).



End of the programme

When the programme has finished a flashing zero **0** is displayed, the DOOR symbol disappears and the door can be opened.

9.8 DELAY START  - symbol

9.9 CHILD SAFETY LOCK  - symbol

First Use

-  Ensure that the electrical and water connections comply with the installation instructions.
-  Remove the polystyrene block and any material from the drum.
-  Run a cotton cycle at 95°C, without any laundry in the machine, to remove any manufacturing residue from the drum and tub. Pour 1/2 a measure of detergent into the dispenser drawer and start the machine.

Personalization

Acoustic signals

The machine is provided with the acoustic device, which sounds in the following cases:

- at the end of the cycle
- in the event of operating problems

By pressing the **3** and **4** buttons simultaneously for about 6 seconds, the acoustic signal is deactivated (except for the events of operating problems).

By pressing these 2 buttons again, the acoustic signal is reactivated.

Child safety lock

This device permits you to leave the appliance unsupervised without having the worry that children might be injured by or cause damage to the appliance.

This function remains able also when the washing machine is not working.

There are two different ways to set this option:

- before pressing the button **7** it will be impossible to start the machine.
- after pressing the button **7** it will be impossible to change any other programme or option.

To enable (disable) this option press simultaneously for about 6 seconds **4** and **5** buttons until the CHILD SAFETY LOCK appears (disappears) on (from) the display.

Daily Use



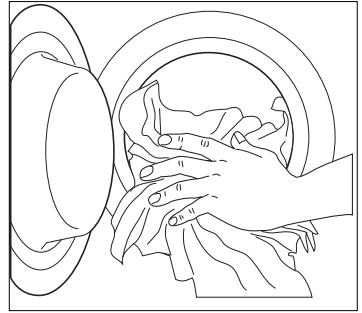

Load the laundry

1. Open the door by carefully pulling the door handle outwards. Place the laundry in the drum, one item at a time, shaking them out as much as possible.
2. Close firmly the door. You must hear a click during closing.
Attention! Do not embed the laundry between the door and the rubber joint.



Measure out the detergent and the fabric softener

Your new appliance was designed to reduce water, energy and detergent consumption.

1. Pull out the dispenser drawer until it stops. Measure out the amount of detergent required, pour it into the main wash compartment  and, if you wish to carry out the **prewash** phase, pour the detergent into the compartment marked . If you wish to perform the **stain** function, pour the stain remover into the compartment .
2. If required, pour fabric softener into the compartment marked  (the amount used must not exceed the **MAX** mark in the drawer). Close the drawer gently.

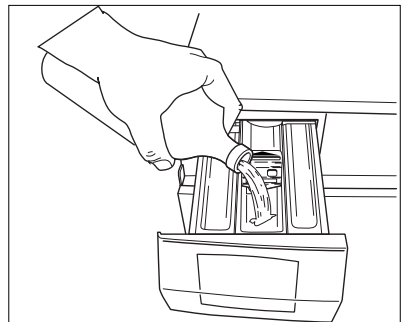
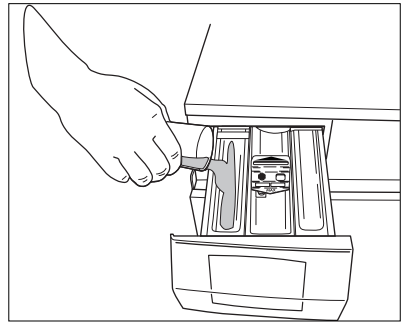

Select the required programme by means of programme selector dial (1)

You can choose the right programme for any type of laundry following the descriptions on the washing programme tables (see «Washing Programmes»).

Turn the programme selector dial to the required programme. The programme selector determines the type of washing cycle (e.g. water level, drum movement, number of rinses) and the washing temperature according to the type of laundry.

The pilot light of button **7** starts to flash and the Display shows the duration of the selected programme.

The selector dial can be turned either clockwise or anticlockwise.

Position **O** = Reset programme/Switching OFF of the machine.

At the end of the programme the selector dial must be turned to position **O, to switch the machine off.**



For the description of each washing programmes of the selector dial, consult the chapter «Washing programmes».

Attention!

If you turn the programme selector dial to another programme when the machine is working, the yellow pilot light of button **7** will flash 3 times and the message **Err** is displayed on the display to indicate a wrong selection. The machine will not perform the new selected programme.

Select the temperature (button 2)

Press this button repeatedly to increase or decrease the temperature, if you want your laundry to be washed at a temperature different from the one proposed by the washing machine.

The maximum temperatures for each washing programme can be checked in the paragraph «Washing programmes».

The symbol of cold wash corresponds to $- \text{ } ^\circ\text{C}$ (**✱**).

Select the spin speed, Night cycle or Rinse hold option (button 3)

Press this button repeatedly to change the spin speed, if you want your laundry to be spun at a speed different from the one proposed by the washing machine.



For the maximum spin speed forseen for each programme consult the chapter «Washing programmes».

Rinse hold: by selecting this option the water of the last rinse is not emptied out to prevent the fabrics from creasing. At the end of the programme, **R** and RINSE HOLD symbol will flash on the display, DOOR symbol (door locked) remains lit, the pilot light of button **7** goes off and the door is blocked to indicate that the water

must be emptied out.

Night cycle: by selecting this option, the machine will not drain the water of the last rinse, so as not to wrinkle the laundry. As all spinning phases are suppressed, this washing cycle is very noiseless and it can be selected at night or in times with a more economical power rate. In some programmes the rinses will be performed with more water. At the end of the programme,  and RINSE HOLD symbol will flash on the display, the DOOR symbol remains lit, the pilot light of button **7** goes off and the door is blocked to indicate that the water must be emptied out.

To empty out the water, please read «At the end of the programme».

Select the desired option by means of button **4** and confirm your choice by means of button **5**

Depending on the programme, different functions can be combined.

Attention: Not all the options are compatible between themselves. The symbols of the incompatible options disappear.

Anyway, if an option, which is not compatible with the set washing programme or any other option, is selected, the **Err** message is displayed for few seconds and the yellow pilot of button **7** light starts flashing.

You must select the options after you have selected the programme but before pressing the button **7**. Press the button **4**: All the option symbols appear on the display.

To scroll all the available options, press the button **4**. The corresponding symbol appear on the display and starts flashing.

Depress the button **5** to activate and confirm your choice. A black dash appears under the selected symbol to indicate that this option has been set. Depress the same button to deactivate the option.

After selecting the options, wait about 10 seconds until the display gets back to the default status. The selected options appear on the display.



For the compatibility between this option and washing programmes consult the chapter «Washing programmes».

PREWASH option

Select this option if you wish your laundry to be prewashed at 30°C before the main wash.

The Prewash ends with a short spin in programmes for COTTON and SYNTHETIC fabrics, whereas in the programmes for DELICATE fabrics the water is only drained.

The relevant symbol will appear on the display.

STAIN option

Select this option to treat heavily soiled or stained laundry with stain remover (extended main wash with time optimised stain action phase).

This option **is not** available with a temperature lower than 40°C.

Attention! If you wish to perform a programme with the stain option, pour stain remover into compartment .

SENSITIVE option

By selecting this button the washing intensity will be reduced. The machine adds one rinse in the programmes for COTTONS, 40°-60° MIX and SYNTHETICS.

This option is non compatible with EXTRA RINSE option.

This option is recommended for non fast coloureds items and for frequently washed items.

Select an additional rinse (EXTRA RINSE)

This appliance is designed for saving water. However, for people with a very delicate skin (allergic to detergents) it may be necessary to rinse the laundry using an extra quantity of water (extra rinse).



If you wish to activate this option permanently for every washing cycle, depress simultaneously **2.** and **3** for about 6 seconds: the symbol EXTRA RINSE illuminates on the display. This option remains active permanently.

If you wish to cancel it depress the same buttons until the symbol disappears.

TIME SAVING option

The washing machine proposes by default the washing cycle for «Normally soiled laundry». The washing cycle can be shorted by means of this button.

By pressing this button you can select the following options:

Daily: by pressing this button once, the corresponding symbol appears on the display and you will be able to short the washing duration for «Daily soiled laundry».

The display will show the shorted washing time. To be used for daily soiled laundry.

Super Quick: by pressing this button twice, the corresponding symbol remains alight on the display and you will be able to short the washing duration for «lightly soiled laundry».

The display will show the shorted washing time. To be used for very lightly soiled laundry only.

Press the START/PAUSE (button 7)

To start the selected programme, press the button **7**; the corresponding red pilot light stops flashing.

The DOOR symbol appears on the display to indicate that the appliance has started operating and the door is locked.

To interrupt a programme which is running, depress the button **7**: the corresponding red pilot light starts to flash.

To restart the programme from the point at which it was interrupted, **press** the START/PAUSE button **again**.

If you have chosen a delayed start, the machine will begin the countdown.

If an incorrect option is selected, the yellow pilot light of the button **7** flashes for 3 times, the message **Err** is displayed for about 2 seconds.

Select the DELAY START by means of button 8

Before you start the programme, if you wish to delay the start, press the button **8** repeatedly, to select the desired delay.

The corresponding symbol will appear on the display

The selected delay time value (up to 20 hours) will appear on the display for about 3 seconds, then the duration of the programme will appear again.

You must select this option after you have set the programme and before you press the button **7**.

You can modify or cancel the delay time at any moment, before you press the button **7**.

If you wish to add laundry in the machine during the delay time, press the button **7** to put the machine in pause. When the DOOR symbol disappears, the door can be opened. After you have closed the door, press the button **7** again.

The washing programme can be delayed from 30 min - 60 min - 90 min, 2 hours and then by 1 hour up to a maximum of 20 hours by means of this button.

Selecting the delayed start:

- Select the programme and the required options;
- Select the delay start;
- Depress button **7**: the machine starts its hourly countdown. The programme will start after the selected delay has expired.

Cancelling the delayed start:

- set the washing machine to PAUSE by pressing the button **7**;
- press the button **8** until the symbol **D'** is displayed;
- press the button **7** again to start the programme.

The DELAY START option can not be selected with DRAIN programme.

Altering an option or a running programme

It is possible to change any option before the programme carries it out. Before you make any change, you must pause the washing machine by pressing the button **7**.

Changing a running programme is possible **only by resetting it**. Turn the programme selector dial to **O/OFF** and then to the new programme position. The washing water in the tub will be not emptied out. Start the new programme by depressing the button **7** again.

Interrupting a programme

Depress the button **7** to interrupt a programme which is running, the corresponding light starts to flash. Depress the button again to restart the programme.

Cancelling a programme

Turn the selector dial to **O/OFF** to cancel a programme which is running. Now you can select a new programme.

Opening the door after the programme has started

First set the machine to pause by pressing the button **7**.

- if the DOOR symbol disappears, the door can be opened.
- if the DOOR symbol doesn't go off, it means that the machine is already heating, that the water level is above the bottom edge of the door. In this case the door can not be opened.
- If you cannot open the door but you need to open it, you have to switch the machine off by turning the selector dial to **O/OFF**. After some minutes the door can be opened (**pay attention to the water level and temperature!**).

At the end of the programme

The machine stops automatically, the pilot light of button **7** pilot light goes off, a flashing **D** appears on the display and the acoustic signal sounds for some minutes.

If you have chosen a programme with Rinse Hold or Night Cycle option selected, **follow the below instruction to empty the water out:**

- turn the programme selector dial to **O/OFF**
- select the DRAIN, SPIN or DELICATE SPIN programme
- reduce the spin speed if needed, by means of the relevant button
- press the button **7**
- when the programme has finished the display shows a flashing **D**. On the display the DOOR symbol disappears and the door can be opened.

Turn the programme selector dial to **O/OFF** to switch the machine off. Remove the laundry from the drum and carefully check that the drum is empty.

If you do not intend to carry out another wash, close the water tap. Leave the door open to prevent the formation of mildew and unpleasant smells.

Washing programmes

Programme/ Temperature	Type of laundry	Options	Description of the programme
WHITE COTTONS 95°-60°	White cotton (heavily soiled items)	Spin reduction/Rinse hold/Night cycle Prewash - Stain - Sensitive - Extra rinse Time saving	Main wash Rinses Long spin at maximum speed
COLOURED COTTONS 60°-50°-40°-30°-cold	White and coloured cotton (normally soiled cotton items)	Spin reduction/Rinse hold/Night cycle Prewash - Stain (*) - Sensitive - Extra rinse Time saving	Main wash Rinses Long spin at maximum speed
HYGIENE 60°	Special programme for white cottons	Spin reduction/Rinse hold Prewash - Stain	Main wash/Rinses Long spin at maximum speed
40-60 MIX 40°	Mixed fabrics	Spin reduction/Rinse hold/Night cycle Prewash - Stain - Sensitive - Extra rinse	Main wash/Rinses Long spin at maximum speed
JEANS 60°-50°-40°-30°-COLD	Special programme for jeans, denim items	Spin reduction/Rinse hold/Night cycle Prewash	Main wash Rinses Long spin at maximum speed
SYNTHETICS 40°-30°-COLD	Synthetic or mixed fabrics	Spin reduction/Rinse hold/Night cycle Prewash - Stain (*) - Sensitive - Extra rinse Time saving	Main wash Rinses Short spin at maximum speed
EASY IRON 60°-50°-40°-30°-COLD	Synthetic or mixed fabrics: underwear, coloured garments, non-shrink shirts, blouses	Spin reduction/Rinse hold Prewash - Extra rinse	Main wash Rinses Short spin at maximum speed
DELICATES 40°-30°-COLD	Delicate fabrics: for example curtains	Spin reduction/Rinse hold/Night cycle Prewash - Stain (*) - Extra rinse Time saving	Main wash Rinses Short spin at maximum speed

Washing programmes

Programme/ Temperature	Type of laundry	Options	Description of the programme
VISCOSE 40°-30°-COLD	Viscose items	Spin reduction/Rinse hold/Night cycle Prewash - Stain (*) - Extra rinse	Main wash Rinses Short spin at maximum speed
RINSES	Separate rinse cycle for hand washed cotton items	Spin reduction/Rinse hold/Night cycle Extra rinse	Rinses Long spin at maximum speed
DRAIN	For emptying out the water		Drain
SPIN	Separate spin for cottons	Spin reduction	Drain and long spin at maximum speed
BLANKET	Separate spin for blankets	Spin reduction	Main wash Rinses Short spin at 800 rpm
WOOL 40°-30°-COLD	Garments bearing the «Pure new wool, non-shrink, machine washable» or «Handwash» label	Spin reduction/Rinse hold/Night cycle	Main wash Rinses Short spin at maximum speed
LINGERIE 40°-30°-COLD	Special programme for extremely delicate handwashed garments	Spin reduction/Rinse hold/Night cycle	Main wash Rinses Short spin at maximum speed
SILK 30°-COLD	Silk items to be gently washed and spun	Spin reduction/Rinse hold/Night cycle	Main wash Rinses Short spin at maximum speed

Washing programmes

Programme/ Temperature	Type of laundry	Options	Description of the programme
SPORT JACKETS 40°-30°-COLD	Special programme for sport clothes	Spin reduction/Rinse hold Extra rinse	Main wash Rinses Short spin at 800 rpm
SPORT INTENSIVE 40°-30°-COLD	Special programme for heavily soiled sportwear items	Spin reduction/Rinse hold/Night cycle Extra rinse	Prewash at 30° Main wash Rinses Short spin at maximum speed
20 MIN - 3 Kg 30°	For slightly soiled fabrics, except wool	Spin reduction	Main wash Rinses Short spin at maximum speed
QUICK INTENSIVE 60°-50°-40°	To use for cotton or mixed fabrics, slightly soiled or worn only once.	Spin reduction/Rinse hold Extra rinse	Main wash Rinses Short spin at maximum speed
ECO 60°	White and fast coloured cotton - economy , lightly-normally soiled items, shirts, underwear.	Spin reduction/Rinse hold/Night cycle Prewash - Stain (*) - Sensitive - Extra rinse	Main wash Rinses Long spin at maximum spin speed
O/OFF	For cancelling the programme which is running or to switch the machine off.		

* Stain option can be selected only at the temperature of 40°C or higher.

Washing programmes

Type of fabric	Max. Load
COTTONS	8 kg
SYNTHETICS, DELICATES AND VISCOSE	4 kg
JEANS	4 kg
EASY IRON	1,5 kg
WOOL (HANDWASH)	2 kg
LINGERIE and SILK	1 kg
SPORT JACKETS	4 kg
20 MIN. - 3 KG	3 kg
SPORT INTENSIVE	4 kg
ECONOMY	8 kg
QUICK INTENSIVE	5 kg
COTTONS + DAILY	8 kg
COTTONS + SUPER QUICK	4 kg
SYNTHETICS/DELICATES + DAILY	4 kg
SYNTHETICS/DELICATES + SUPER QUICK	2 kg

Programme information

HYGIENE	The washing programme for white cottons. This program eliminates the micro-organisms thanks to the washing by 60°C and an additional rinse. In this way the action is more effective. Put into the compartment STAIN a special additive for hygiene and select the option STAIN.
MIX 40-60	Special programme for white and coloured cotton suitable for different washing temperatures. This programme can be used for laundry, which should be washed at 40°C or 60°C separately. So, you can put into the drum the maximum load capacity in order to save energy and water. You will obtain the same good washing result as a normal programme at 60°C.
JEANS	With this programme it is possible to wash items like pants, shirts or jackets in jeans and also jersey realized with hi-tech materials. (The EXTRA RINSE option will be activated automatically).
EASY IRON	Selecting this programme the laundry is gently washed and spun to avoid any creasing. In this way ironing is easier. Furthermore the machine will perform additional rinses.
VISCOSE	Special gentle programme for fabrics such a viskose, cupro, lyocell. It performs an cleaning action more intensive than the HANDWASH programme.
WOOL HANDWASH	Washing programme for machine washable wool as well as for hand washable woollens and delicate fabrics with the «hand washing» care symbol  .
LINGERIE	This programme is suitable for very delicate items, as lingerie, bras and underwear etc.
SILK	Delicate washing programme suitable for silk and mixed synthetic items.

Programme information

SPORT JACKETS	Special program for sport clothes. By selecting this program, do not add any additives.
SPORT INTENSIVE	This programme is suitable for washing heavily soiled sport items. The machine will add automatically a prewash phase before the main wash to eliminate mud stains. We recommend you NOT to put the detergent into the compartment II of the detergent drawer.
20 MIN. – 3 Kg	Special program at 30°C, duration - approx. 20 minutes, ideal for laundry to be refreshed: e.g. a sport jacket worn only once or slightly soiled or new garments.
QUICK INTENSIVE	Quick washing programme, to be used for lightly soiled white/fast coloured cottons and mixed fabrics.
ECO	This programme can be selected for slightly or normally soiled cotton items. The temperature will decrease and the washing time will be extended. This allows to obtain a good washing efficiency by saving energy.
RINSES	With this programme it is possible to rinse and spin cotton garments which have been washed by hand. The machine performs some additional rinses, followed by a final long spin. The spin speed can be reduced by relevant button.
DRAIN	For emptying out the water of the last rinse in programmes with the RINSE HOLD and NIGHT CYCLE option. Before selecting this programme the selector dial must be turned to ○ .
SPIN	Separate spin for hand washed garments and after programmes with the RINSE HOLD and NIGHT CYCLE option. Before selecting this programme the selector dial must be turned to ○ . You can choose the speed by means of the relevant button to adapt it to the fabrics to be spun.

Preparing the wash cycle

Sorting out the laundry

Follow the wash code symbols on each garment label and the manufacturer's washing instructions. Sort the laundry as follows: whites, coloureds, synthetics, delicates, woollens.

Temperatures

95° or 90°	for normally soiled white cottons and linen (e.g. tea cloths, towels, tablecloths, sheets...).
60°/50°	for normally soiled, colour fast garments (e.g. shirts, night dresses, pyjamas...) in linen, cotton or synthetic fibres and for lightly soiled white cotton (e.g. underwear).
40°-30°- Cold	for delicate items (e.g. net curtains), mixed laundry including synthetic fibres and woollens bearing the label «pure new wool, machine washable, non-shrink».

Before loading the laundry

Never wash whites and coloureds together. Whites may lose their "whiteness" in the wash.

New coloured items may run in the first wash; they should therefore be washed separately the first time.

Make sure that no metal objects are left in the laundry (e.g. hair clips, safety pins, pins).

Button up pillowcases, close zip fasteners, hooks and poppers. Tie any belts or long tapes.

Remove persistent stains before washing.

Rub particularly soiled areas with a special detergent or detergent paste.

Treat curtains with special care. Remove hooks or tie them up in a bag or net.

Maximum loads

Recommended loads are indicated in the washing programme charts.

General rules:

Cotton, linen: drum full but not too tightly packed;

Synthetics: drum no more than half full;

Delicate fabrics and woollens: drum no more than one third full.

Washing a maximum load makes the most efficient use of water and energy.

For heavily soiled laundry, reduce the load size.

Washing a maximum load makes the most efficient use of water and energy. For heavily soiled laundry, reduce the load size.

Laundry weights

The following weights are indicative:

bathrobe	1200 g
napkin	100 g
quilt cover	700 g
sheet	500 g
pillow case	200 g
tablecloth	250 g
towelling towel	200 g
tea cloth	100 g
night dress	200 g
ladies' briefs	100 g
man's work shirt	600 g
man's shirt	200 g
man's pyjamas	500 g
blouse	100 g
men's underpants	100 g

Removing stains

Stubborn stains may not be removed by just water and detergent. It is therefore advisable to treat them prior to washing.

Blood: treat fresh stains with cold water. For dried stains, soak overnight in water with a special detergent then rub in the soap and water.

Oil based paint: moisten with benzine stain remover, lay the garment on a soft cloth and dab the stain; treat several times.

Dried grease stains: moisten with turpentine, lay the garment on a soft surface and dab the stain with the fingertips and a cotton cloth.

Rust: oxalic acid dissolved in hot water or a rust removing product used cold. Be careful with rust stains which are not recent since the cellulose structure will already have been damaged and the fabric tends to hole.

Mould stains: treat with bleach, rinse well (whites and fast coloureds only).

Grass: soap lightly and treat with bleach (whites and fast coloureds only).

Ball point pen and glue: moisten with acetone (*), lay the garment on a soft cloth and dab the stain.

Lipstick: moisten with acetone as above, then treat stains with methylated spirits. Treat any residual marks with bleach.

Red wine: soak in water and detergent, rinse and treat with acetic or citric acid, then rinse. Treat any residual marks with bleach.

Ink: depending on the type of ink, moisten the fabric first with acetone (*), then with acetic acid; treat any residual marks on white fabrics with bleach and then rinse thoroughly.

Tar stains: first treat with stain remover, methylated spirits or benzine, then rub with detergent paste.

(*) do not use acetone on artificial silk.

Detergents and additives

Good washing results also depend on the choice of detergent and use of the correct quantities to avoid waste and protect the environment.

Although biodegradable, detergents contain substances which, in large quantities, can upset the delicate balance of nature.

The choice of detergent will depend on the type of fabric (delicates, woollens, cottons, etc.), the colour, washing temperature and degree of soiling.

All commonly available washing machine detergents may be used in this appliance:

- powder detergents for all types of fabric,
- powder detergents for delicate fabrics (60°C max) and woollens,
- liquid detergents, preferably for low temperature wash programmes (60°C max) for all types of fabric, or special for woollens only.

The detergent and any additives must be placed in the appropriate compartments of the dispenser drawer before starting the wash programme.

If using concentrated powder or liquid detergents, a programme **without** prewash must be selected.

The washing machine incorporates a recirculation system which allows an optimal use of the concentrated detergent.

Pour liquid detergent into the dispenser drawer compartment marked  **just before** starting the programme.

Any fabric softener or starching additives must be poured into the compartment marked  before starting the wash programme.

Follow the product manufacturers' recommendations on quantities to use and **do not exceed the «MAX» mark in the detergent dispenser drawer.**

Quantity of detergent to be used

The type and quantity of detergent will depend on the type of fabric, load size, degree of soiling and hardness of the water used.

Follow the product manufacturers' instructions on quantities to use.

Use less detergent if:

- you are washing a small load,
- the laundry is lightly soiled,
- large amounts of foam form during washing. For the stain treatment before the washing cycle, follow the product manufacturers' instructions on detergent quantities. If you use any specific product to remove the stains, you must start the cycle of washing immediately .

Degrees of water hardness













Water hardness is classified in so-called "degrees" of hardness. Information on hardness of the water in your area can be obtained from the relevant water supply company, or from your local authority.



Note: A water softener must be added when water has a medium-high degree of hardness (from degree of hardness II). Follow the manufacturer's instructions. The quantity of detergent can then always be adjusted to degree of hardness I (= soft).





Level	Characteristic	Degrees of water hardness	
		German °dH	French °T.H.
1	soft	0-7	0-15
2	medium	8-14	16-25
3	hard	15-21	26-37
4	very hard	> 21	> 37





i International wash code symbols







These symbols appear on fabric labels, in order to help you choose the best way to treat your laundry.

<p>Energetic wash</p>   <p>Delicate wash</p>	 <p>Max. wash temperature 95°C</p>	 <p>Max. wash temperature 60°C</p> 	 <p>Max. wash temperature 40°C</p>  	 <p>Max. wash temperature 30°C</p> 	 <p>Hand wash</p>	 <p>Do not wash at all</p>
--	---	---	---	---	--	--

 <p>Bleaching</p>	 <p>Bleach in cold water</p>	 <p>Do not bleach</p>
---	---	--

 <p>Ironing</p>	 <p>Hot iron max 200°C</p>	 <p>Warm iron max 150°C</p>	 <p>Lukewarm iron max 110°C</p>	 <p>Do not iron</p>
---	---	--	--	--

 <p>Dry cleaning</p>	 <p>Dry cleaning in all solvents</p>	 <p>Dry cleaning in perchlorethylene, petrol, pure alcohol, R 111 & R 113</p>	 <p>Dry cleaning in petrol, pure alcohol and R 113</p>	 <p>Do not dry clean</p>
--	---	--	---	---

 <p>Drying</p>	 <p>Flat</p>	 <p>On the line</p>	 <p>On clothes hanger</p>	 <p>high temperature</p>  <p>low temperature</p> <p>Tumble dry</p>	 <p>Do not tumble dry</p>
--	---	--	--	--	--

Care and cleaning

You must DISCONNECT the appliance from the electricity supply, before you can carry out any cleaning or maintenance work.

Descaling

The water we use normally contains lime. It is a good idea to periodically use a water softening powder in the machine. Do this separately from any laundry washing, and according to the softening powder manufacturer's instructions.

This will help to prevent the formation of lime deposits.

After each wash

Leave the door open for a while. This helps to prevent mould and stagnant smells forming inside the appliance. Keeping the door open after a wash will also help to preserve the door seal.

Maintenance wash

With the use of low temperature washes it is possible to get a build up of residues inside the drum.

We recommend that a maintenance wash be performed on a regular basis.

To run a maintenance wash:

- The drum should be empty of laundry.
- Select the hottest cotton wash programme.
- Use a normal measure of detergent, must be a powder with biological properties.

External cleaning

Clean the exterior cabinet of the appliance with soap and water only, and then dry thoroughly.

Important! Do not use methylated spirits, solvents or similar products to clean the cabinet.

Detergent dispenser drawer

The detergent dispenser drawer should be cleaned regularly.

1. Remove the detergent dispenser drawer by pulling it firmly.

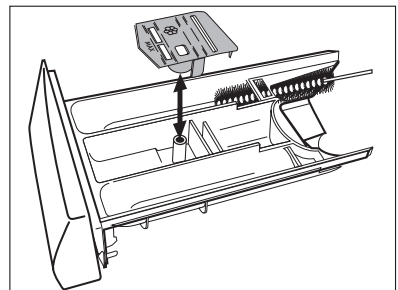

2. Remove the conditioner insert from the middle compartment.
3. Clean all parts with water.
4. Put the conditioner insert in as far as it will go, so that it is firmly in place.
5. Clean all parts of the washing machine, especially the nozzles in the top of the washing-in chamber, with a brush.
6. Insert the detergent dispenser drawer in the guide rails and push it in.

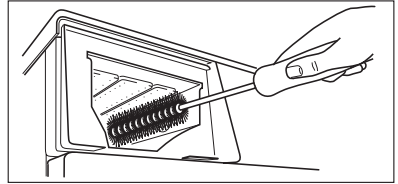

Drain pump

The pump should be inspected regularly and particularly if

- the machine does not empty and/or spin
- the machine makes an unusual noise during draining due to objects such as safety pins, coins etc. blocking the pump.

Proceed as follows:

1. Disconnect the appliance.
2. If necessary wait until the water has cooled down.
3. Open the pump door.
4. Place a container close to the pump to collect any spillage.
5. Release the emergency emptying hose, place it in the container and remove its cap.

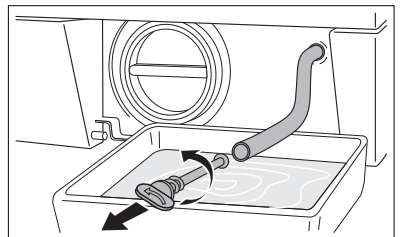
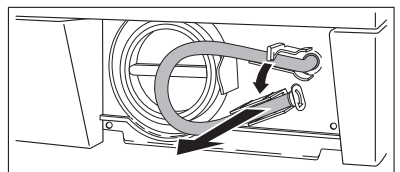
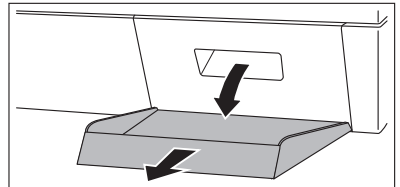

6. When no more water comes out, unscrew the pump and remove it. Always keep a rag nearby to dry up spillage of water when removing the pump.
7. Remove any objects from the pump impeller by rotating it.
8. Put the cap back on the emergency emptying hose and place the latter back in its seat.
9. Screw the pump fully in.
10. Close the pump door.

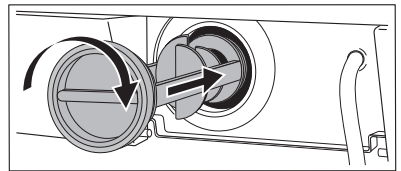
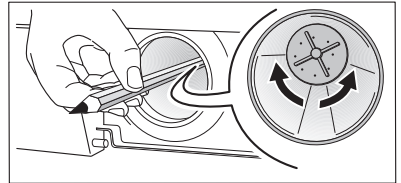
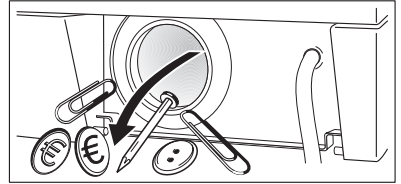
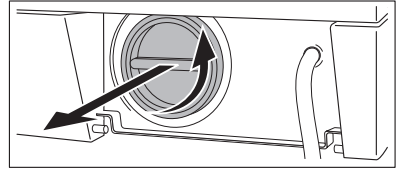

Warning!

When the appliance is in use and depending on the programme selected there can be hot water in the pump. Never remove the pump cover during a wash cycle, always wait until the appliance has finished the cycle, and is empty. When replacing the cover, ensure it is securely retightened so as to stop leaks and young children being able to remove it.

Water inlet filter

If you notice that the machine is taking longer to fill, check that the filter in the water inlet hose is not blocked.

1. Turn off the water tap.
2. Unscrew the hose from the tap.
3. Clean the filter in the hose with a stiff brush.
4. Screw the hose back onto the tap.

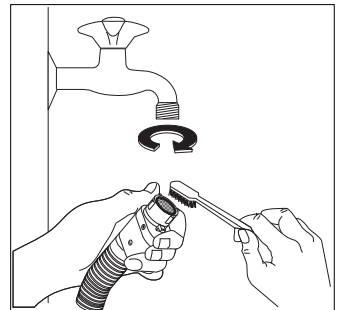

Frost precautions

If the machine is installed in a place where the temperature could drop below 0°C, proceed as follows:

1. Close the water tap and unscrew the water inlet hose from the tap.
2. Place the end of the emergency emptying hose and that of the inlet hose in a bowl placed on the floor and let water drain out.
3. Screw the water inlet hose back on and reposition the emergency emptying hose after having put the cap on again.

By doing this, any water remaining in the machine is removed, avoiding ice forming and consequently damage to the appliance.

When you use the machine again, make sure that the ambient temperature is above 0°C.

Emergency emptying out

If the water is not discharged, proceed as follows to empty out the machine:

1. pull out the plug from the power socket;
2. close the water tap;
3. if necessary, wait until the water has cooled down;
4. open the pump door;
5. place a bowl on the floor and place the end of the emergency emptying hose into the bowl. Remove its cap. The water should drain by gravity into the bowl. When the bowl is full, put the cap back on the hose. Empty the bowl. Repeat the procedure until water stops flowing out;
6. clean the pump if necessary as previously described;
7. replace the emergency emptying hose in its seat after having plugged it;
8. screw the pump again and close the door.

Something not working

Certain problems are due to lack of simple maintenance or oversights, which can be solved easily without calling out an engineer. Before contacting your local Service Centre, please carry out the checks listed below.

During machine operation it is possible that the **yellow** pilot light of button **7** flashes, one of the following alarm codes appears on the display and at the same some acoustic signals sound every 20 seconds to indicate that the machine is not working:

- **E10** : problem with the water supply
- **E20** : problem with the water draining
- **E40** : door open.
- **EFO** : Anti-flooding system has activated

Once the problem has been eliminated, press the button **7** to restart the programme. If after all checks, the problem persists, contact your local Service Centre.

Problem	Possible cause/Solution
<p>The washing machine does not start:</p>	<p>The door has not been closed. E40</p> <ul style="list-style-type: none"> • Close firmly the door. <p>The plug is not properly inserted in the power socket.</p> <ul style="list-style-type: none"> • Insert the plug into the power socket. <p>There is no power at the socket.</p> <ul style="list-style-type: none"> • Please check your domestic electrical installation. <p>The main fuse has blown.</p> <ul style="list-style-type: none"> • Replace the fuse. <p>The selector dial is not correctly positioned and the button 7 has not been depressed.</p> <ul style="list-style-type: none"> • Please turn the selector dial and press the button 7 again. <p>The delay start has been selected.</p> <ul style="list-style-type: none"> • If the laundry is to be washed immediately, cancel the delay start.

Problem	Possible cause/Solution
<p>The machine does not fill:</p>	<p>The water tap is closed. <i>E10</i></p> <ul style="list-style-type: none"> • Open the water tap. <p>The inlet hose is squashed or kinked. <i>E10</i></p> <ul style="list-style-type: none"> • Check the inlet hose connection. <p>The filter in the inlet hose is blocked. <i>E10</i></p> <ul style="list-style-type: none"> • Clean the water inlet hose filter. <p>The door is not properly closed. <i>E40</i></p> <ul style="list-style-type: none"> • Close firmly the door.
<p>The machine fills then empties immediately:</p>	<p>The end of the drain hose is too low.</p> <ul style="list-style-type: none"> • Refer to relevant paragraph in «water drainage» section.
<p>The machine does not empty and/or does not spin:</p>	<p>The drain hose is squashed or kinked. <i>E20</i></p> <ul style="list-style-type: none"> • Check the drain hose connection. <p>The drain pump is clogged. <i>E20</i></p> <ul style="list-style-type: none"> • Clean the drain pump. <p>The option RINSE HOLD or NIGHT CYCLE has been selected.</p> <ul style="list-style-type: none"> • Disable the RINSE HOLD or NIGHT CYCLE option. • Select DRAIN or SPIN programme. <p>The laundry is not evenly distributed in the drum.</p> <ul style="list-style-type: none"> • Redistribute the laundry.
<p>There is water on the floor:</p>	<p>Too much detergent or unsuitable detergent (creates too much foam) has been used.</p> <ul style="list-style-type: none"> • Reduce the detergent quantity or use another one. <p>Check whether there are any leaks from one of the inlet hose fittings. It is not always easy to see this as the water runs down the hose; check to see if it is damp.</p> <ul style="list-style-type: none"> • Check the water inlet hose connection. <p>The drain hose is damaged.</p> <ul style="list-style-type: none"> • Change it with a new one. <p>The cap on the emergency emptying hose has not been replaced after cleaning the pump.</p> <ul style="list-style-type: none"> • Put the cap back on the emergency emptying and place the latter back in its seat.

Problem	Cause possible/Solution
Unsatisfactory washing results:	<p>Too little detergent or unsuitable detergent has been used.</p> <ul style="list-style-type: none"> • Increase the detergent quantity or use another one. <p>Stubborn stains have not been treated prior to washing.</p> <ul style="list-style-type: none"> • Use commercial products to treat the stubborn stains. <p>The correct temperature was not selected.</p> <ul style="list-style-type: none"> • Check if you have selected the correct temperature. <p>Excessive laundry load.</p> <ul style="list-style-type: none"> • Introduce into the drum less laundry.
The door will not open:	<p>The programme is still running.</p> <ul style="list-style-type: none"> • Wait the end of washing cycle. <p>The door lock has not been released.</p> <ul style="list-style-type: none"> • Check if the DOOR symbol appears on the display. <p>There is water in the drum.</p> <ul style="list-style-type: none"> • Select drain or spin programme to empty out the water.
The machine vibrates or is noisy:	<p>The transit bolts and packing have not been removed.</p> <ul style="list-style-type: none"> • Check the correct installation of the appliance. <p>The support feet have not been adjusted</p> <ul style="list-style-type: none"> • Check the correct levelling of the appliance. <p>The laundry is not evenly distributed in the drum.</p> <ul style="list-style-type: none"> • Redistribute the laundry. <p>Maybe there is very little laundry in the drum.</p> <ul style="list-style-type: none"> • Load more laundry.
Spinning starts late or the machine does not spin:	<p>The electronic unbalance detection device has cut in because the laundry is not evenly distributed in the drum. The laundry is redistributed by reverse rotation of the drum. This may happen several times before the unbalance disappears and normal spinning can resume. If, after some minutes, the laundry is still not evenly distributed in the drum, the machine will not spin.</p> <ul style="list-style-type: none"> • Redistribute the laundry.

Problem	Cause possible/Solution
<p>The machine makes an unusual noise</p>	<p>The machine is fitted with a type of motor which makes an unusual noise compared with other traditional motors. This new motor ensures a softer start and more even distribution of the laundry in the drum when spinning, as well as increased stability of the machine.</p>
<p>No water is visible in the drum:</p>	<p>Machines based on modern technology operate very economically using very little water without affecting performance.</p>
<p>The display shows the alarm code <i>EFD</i>:</p>	<p>Anti-flooding system has activated.</p> <ul style="list-style-type: none"> • Disconnect the appliance and contact the Service Force Centre
<p>The drum light doesn't work:</p>	<p>Please contact your local Service Centre.</p>

If you are unable to identify or solve the problem, contact our service centre. Before telephoning, make a note of the model, serial number and purchase date of your machine: the Service Centre will require this information.

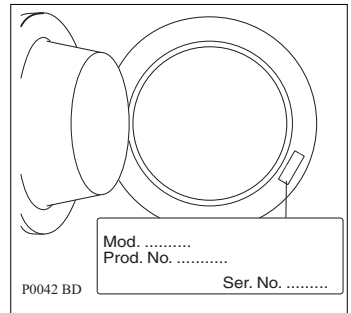

Technical Data

Dimensions	Width Height Depth (door included)	60 cm 85 cm 63 cm
Electrical connection	Power supply voltage/frequency Total power absorbed Minimum fuse protection	230 V/50 Hz 2200 W 10 A
Water supply pressure	Minimum Maximum	0,05 MPa 0,8 MPa
Maximum Load	Cottons	8,0 kg
Spin Speed	Maximum	1200 rpm (L 72950) 1400 rpm (L 74950)



Consumption value

Programme	Water consumption (in litres)	Energy consumption (in kWh)	Programme duration (in minutes)
Cottons 95°	65	2,55	For the duration of the programmes, please refer to the display on the control panel.
Hygiene 60°	70	1,8	
MIX 40°	60	1,4	
Jeans 60°	60	1,1	
Synthetics 40°	55	1,15	
Easy iron 60°	63	0,55	
Delicates 40°	67	0,6	
Viscose 40°	65	0,6	
Rinses	47	0,15	
Drain	-	-	
Spin	-	-	
Blanket	78	0,6	
Wool 40°	63	0,5	
Lingerie 40°	60	0,45	
Silk 30°	52	0,3	
Sport Jackets 40°	70	0,55	
Sport Intensive 40°	65	1,0	
20 MIN.- 3 Kg 30°	50	0,2	
Quick Intensive 60°	50	1,2	
(*) Eco 60°	60	1,36	

i The consumption data shown on this chart is to be considered purely indicative, as it may vary depending on the quantity and type of laundry, on the inlet water temperature and on the ambient temperature. It refers to the highest temperature for each wash programme.

i (*) «Economy 60°C» with a load of 8 kg is the reference programme for the data entered in the energy label, in compliance with EEC 92/75 standards.

Installation

Unpacking

All transit bolts and packing must be removed before using the appliance.

You are advised to keep all transit devices so that they can be refitted if the machine ever has to be transported again.

1. After removing all the packaging, carefully lay machine on it's back to remove the polystyrene base from the bottom.



2. Remove the power supply cable and the draining hose from the hose holders on the rear of the appliance.

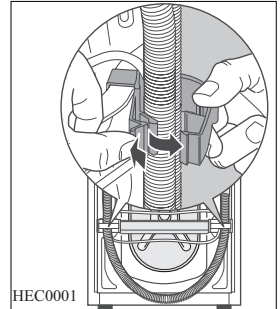

3. With a suitable spanner unscrew and remove the central rear bolt **A**.

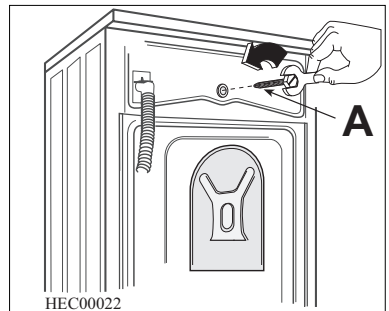

4. Unscrew and remove the two large rear bolts **B** and the six smaller bolts **C**.

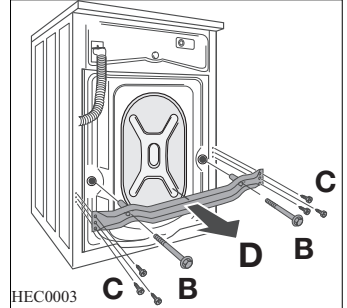

5. Remove the bracket **D** and tighten up the six smaller bolts **C**. Slide out the relevant plastic spacer **E**.

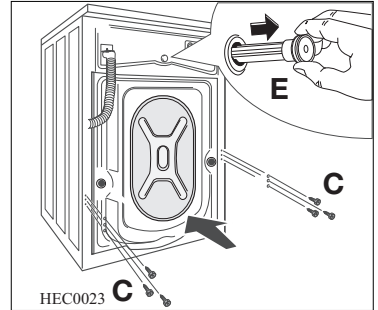

6. Open the porthole, take out the inlet hose from the drum and remove the polystyrene block fitted on the door seal.

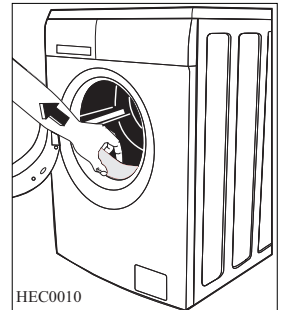

7. Fill the smaller upper hole and the two large ones with the corresponding plastic plug caps supplied in the bag containing the instruction booklet.
8. Connect the water inlet hose as described under the paragraph «Water inlet».

All the different plug caps are supplied with the appliance in the plastic bag containing the instruction booklet.

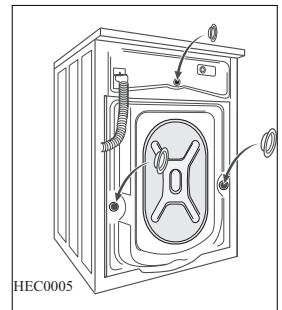

Positioning and levelling

Install the machine on a flat hard floor.

Make sure that air circulation around the machine is not impeded by carpets, rugs etc.

Before placing it on small tiles, apply a rubber coating.

Never try to correct any unevenness in the floor by putting pieces of wood, cardboard or similar materials under the machine.

If it is impossible to avoid positioning the machine next to a gas cooker or coal-burning stove, an insulating panel covered with aluminium foil on the side facing the cooker or stove, must be inserted between the two appliances.

The machine must not be installed in rooms where the temperature can drop below 0.

The water inlet hose and the drain hose must not be kinked.

Please ensure that when the appliance is installed, it is easily accessible for the engineer in the event of a breakdown.

Carefully level by screwing the adjustable feet in or out. Never place cardboard, wood or similar materials under the machine to compensate for any unevenness in the floor.

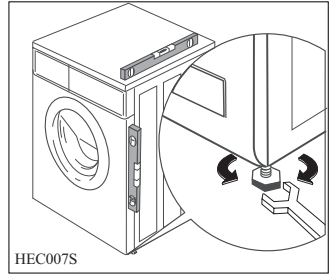

Automatic foot: The rear foot on the left-hand side of your washing machine is built as a shock absorbing foot, which is why the appliance gives in the back left-hand corner if put under load. The automatic foot guarantees that the appliance does not move even at high spin speeds. Basically the automatic foot does not need to be set.

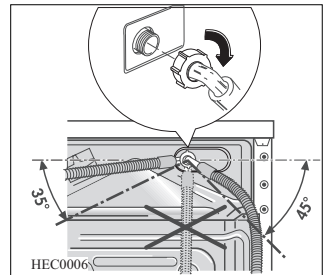

Water inlet

An inlet hose is supplied and can be found inside the machine drum.

Do not use the hose from your previous machine to connect to the water supply.

This appliance must be connected to a cold water supply.

1. Open the porthole and extract the inlet hose.
2. Connect the hose with the angled connection to the machine.

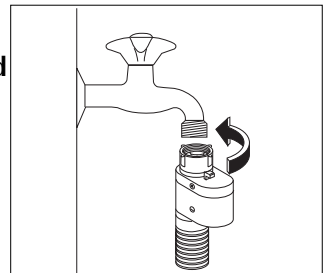



Do not place the inlet hose downwards. Angle the hose to the left or right depending on the position of your water tap.

3. Set the hose correctly by loosening the ring nut.

After positioning the inlet hose, be sure to tighten the ring nut again to prevent leaks.

4. Connect the hose to a tap with a 3/4" thread. Always use the hose supplied with the appliance.

The inlet hose must not be lengthened. If it is too short and you do not wish to move the tap, you will have to purchase a new, longer hose specially designed for this type of use.

Water-stop device

The inlet hose is provided with a water stop device, which protects against damage caused by water leaks in the hose which could develop due to natural ageing of the hose. This fault is shown by a red sector in the window "A". Should this occur, turn the water tap off and refer to your Service Centre to replace the hose.

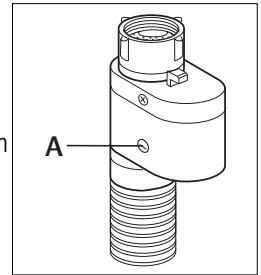

Water drainage

The end of the drain hose can be positioned in three ways:

Hooked over the edge of a sink using the plastic hose guide supplied with the machine.

In this case, make sure the end cannot come unhooked when the machine is emptying.

This could be done by tying it to the tap with a piece of string or attaching it to the wall.

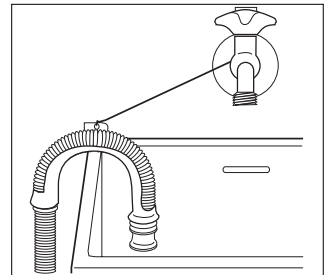

In a sink drain pipe branch. This branch must be above the trap so that the bend is at least 60 cm above the ground.

Directly into a drain pipe at a height of not less than 60 cm and not more than 90 cm.

The end of the drain hose must always be **ventilated**, i.e. the inside diameter of the drain pipe must be larger than the outside diameter of the drain hose.

The drain hose must not be kinked.

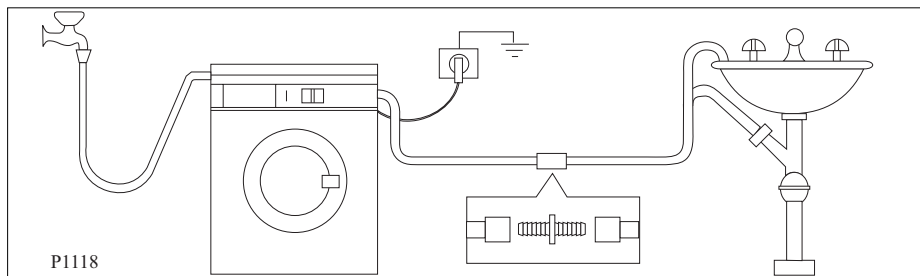

Important!

The drain hose may be extended to a maximum of 4 metres. An additional drain hose and joining piece is available from your local Service Centre.

Electrical connection

⚠ Information on the electrical connection is given on the rating plate on the inner edge of the appliance door and in the chapter «Technical Data».

Check that your domestic electrical installation can take the maximum load required, also taking into account any other appliances in use.

⚠ **Connect the machine to an earthed socket.**

⚠ **The manufacturer does not accept any responsibility for damage or injury through failure to comply with the above safety precaution.**

⚠ **The power supply cable must be easily accessible after installing the machine.**

⚠ **Should the appliance power supply cable need to be replaced, this must be carried out by a Service Centre.**

Permanent connection

In the case of a permanent connection it is necessary that you install a double pole switch between the appliance and the electricity supply (mains), with a minimum gap of 3 mm between the switch contacts and of a type suitable for the required load in compliance with the current electrical regulations.

The switch must not break the yellow and green earth cable at any point.

This operation must be performed by a qualified electrician.

Environment concerns

Packaging materials

The materials marked with the symbol  are recyclable.

>PE<=polyethylene

>PS<=polystyrene

>PP<=polypropylene

This means that they can be recycled by disposing of them properly in appropriate collection containers.

Old machine

Use authorised disposal sites for your old appliance. Help to keep your country tidy!

The symbol  on the product or on its packaging indicates that this product may not be treated as household waste. Instead it shall be handed over to the applicable collection point for the recycling of electrical and electronic equipment. By ensuring this product is disposed of correctly, you will help prevent potential negative consequences for the environment and human health, which could otherwise be caused by inappropriate waste handling of this product. For more detailed information about recycling of this product, please contact your local city office, your household waste disposal service or the shop where you purchased the product.

Ecological hints

To save water, energy and to help protect the environment, we recommend that you follow these tips:

- Normally soiled laundry may be washed without prewashing in order to save detergent, water and time (the environment is protected too!).
- The machine works more economically if it is fully loaded.
- With adequate pre-treatment, stains and limited soiling can be removed; the laundry can then be washed at a lower temperature.
- Measure out detergent according to the water hardness, the degree of soiling and the quantity of laundry being washed.



European Guarantee

This appliance is guaranteed by Electrolux in each of the countries listed at the back of this user manual, for the period specified in the appliance guarantee or otherwise by law. If you move from one of these countries to another of the countries listed, the appliance guarantee will move with you subject to the following qualifications:

- The appliance guarantee starts from the date you first purchased the appliance which will be evidenced by production of a valid purchase document issued by the seller of the appliance.
- The appliance guarantee is for the same period and to the same extent for labour and parts as exists in your new country of residence for this particular model or range of appliances.
- The appliance guarantee is personal to the original purchaser of the appliance and cannot be transferred to another user.
- The appliance is installed and used in accordance with instructions issued by Electrolux and is only used within the home, i.e. is not used for commercial purposes.
- The appliance is installed in accordance with all relevant regulations in force within your new country of residence.

The provisions of this European Guarantee do not affect any of the rights granted to you by law.

www.electrolux.com

		
Albania	+35 5 4 261 450	Rr. Pjeter Bogdani Nr. 7 Tirane
Belgique/België/Belgien	+32 2 363 04 44	Bergensesteenweg 719, 1502 Lembeek
Česká republika	+420 2 61 12 61 12	Budějovická 3, Praha 4, 140 21
Danmark	+45 70 11 74 00	Sjællandsgade 2, 7000 Fredericia
Deutschland	+49 180 32 26 622	Muggenhofer Str. 135, 90429 Nürnberg
Eesti	+37 2 66 50 030	Pärnu mnt. 153, 11624 - Tallinn
España	+34 902 11 63 88	Carretera M-300, Km. 29,900 Alcalá de Henares Madrid
France	www.electrolux.fr	
Great Britain	+44 8705 929 929	Addington Way, Luton, Bedfordshire LU4 9QQ
Hellas	+30 23 10 56 19 70	4, Limnou Str., 54627 Thessaloniki
Hrvatska	+38 51 63 23 338	Slavonska avenija 3, 10000 Zagreb
Ireland	+353 1 40 90 753	Longmile Road Dublin 12
Italia	+39 (0) 434 558500	C.so Lino Zanussi, 26 - 33080 Porcia (PN)
Latvija	+37 17 84 59 34	Kr. Barona iela 130/2, LV-1012, Riga
Lituanija	+370 5 27 80 609	Verkių 2 9, 09108 Vilnius, Lithuania
Luxembourg	+35 2 42 43 13 01	Rue de Bitbourg, 7, L-1273 Hamm
Magyarország	+36 1 252 1773	H-1142 Budapest XIV, Erzsébet királyné útja 87
Nederland	+31 17 24 68 300	Vennootsweg 1, 2404 CG - Alphen aan den Rijn
Norge	+47 81 5 30 222	Risløkkvn. 2 , 0508 Oslo
Österreich	+43 18 66 400	Herziggasse 9, 1230 Wien
Polska	+48 22 43 47 300	ul. Kolejowa 5/7, Warsaw
Portugal	+35 12 14 40 39 39	Quinta da Fonte - Edifício Gonçalves Zarco - Q35 -2774-518 Paço de Arcos
Romania	+40 21 451 20 30	Str. Garii Progresului 2, S4, 040671 RO
Schweiz-Suisse-Svizzera	+41 62 88 99 111	Industriestrasse 10, CH-5506 Mägenwil
Slovenija	+38 61 24 25 731	Tr aška 132, 1000 Ljubljana
Slovensko	+421 2 43 33 43 22	Electrolux Slovakia s.r.o., Electrolux Domáce spotrebiče SK, Seberinoho 1, 821 03 Bratislava
Suomi	www.electrolux.fi	
Sverige	+46 (0)771 76 76 76	Electrolux Service, S:t Göransgatan 143, S-105 45 Stockholm
Türkiye	+90 21 22 93 10 25	Tarlabaşı caddesi no : 35 Taksim Istanbul
Россия	+7 095 937 7837	129090 Москва, Олимпийский проспект, 16, БЦ «Олимпик»

www.electrolux.com

www.aeg-electrolux.com.es

Subject to change without notice

132 969 530-00-372007

PERFEKT IN FORM UND FUNKTION

